

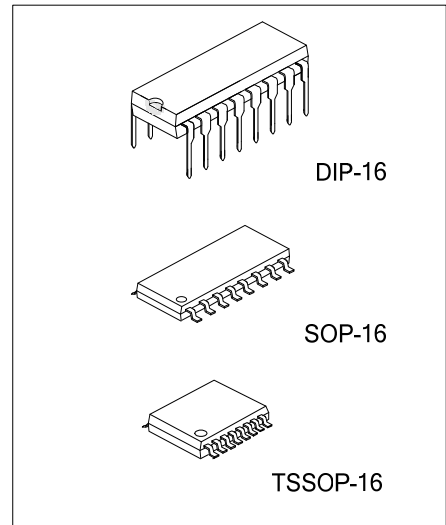

TL494-Q

LINEAR INTEGRATED CIRCUIT

VOLTAGE MODE PWM CONTROL CIRCUIT



DESCRIPTION

The UTC **TL494-Q** incorporates all the functions required in the construction of a pulse-width modulation switching circuit. Designed primarily for switching power supply control or DC-DC converters, it offers the systems engineer the flexibility to tailor control circuitry to its own application.

FEATURES

- * Complete PWM power control circuitry
- * Uncommitted outputs for 200mA sink or source current
- * Output control selects single ended or push pull operation
- * Internal circuitry prohibits double pulses over total range
- * Easy synchronization

ORDERING INFORMATION

Ordering Number		Package	Packing
Lead Free	Halogen Free		
TL494L-D16-T	TL494G-D16-T	DIP-16	Tube
TL494L-S16-R	TL494G-S16-R	SOP-16	Tape Reel
TL494L-P16-R	TL494G-P16-R	TSSOP-16	Tape Reel

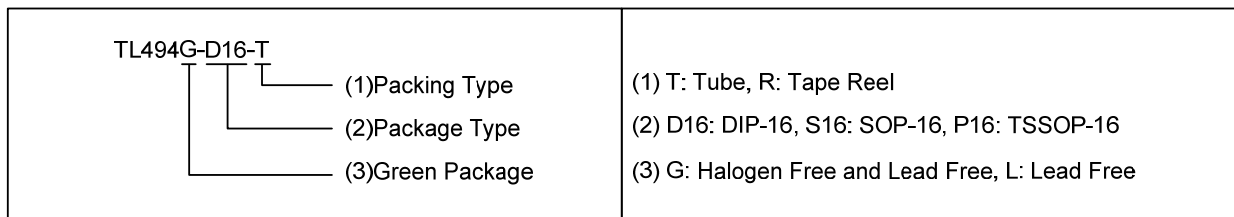

MARKING

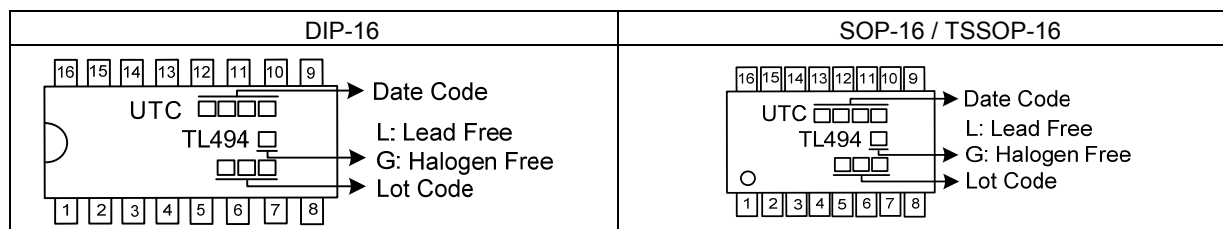

■ PIN CONFIGURATION

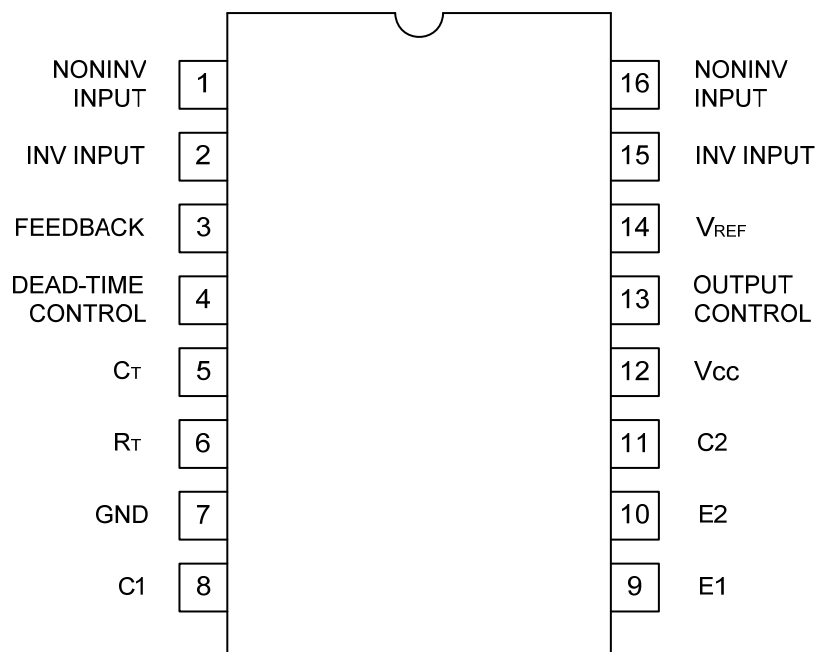

■ PIN DESCRIPTION

PIN No.	SYMBAL	NAME AND FUNCTION
1, 16	NONINV INPUT	Error Amplifier NONINV Input
2, 15	INV INPUT	Error Amplifier INV Input
3	FEEDBACK	Output Feedback Voltage
4	DEAD-TIME CONTROL	Output DEAD-TIME Control
5	CT	Timing Capacitor
6	RT	Timing Resistor
7	GND	Ground
8	C1	Internal Power NPN Collect1
9	E1	Internal Power NPN Emitter1
10	E2	Internal Power NPN Emitter2
11	C2	Internal Power NPN Collect2
12	V _{CC}	Supply Voltage
13	OUTPUT CONTROL	Output mode select
14	V _{REF}	Reference Voltage

■ BLOCK DIAGRAM

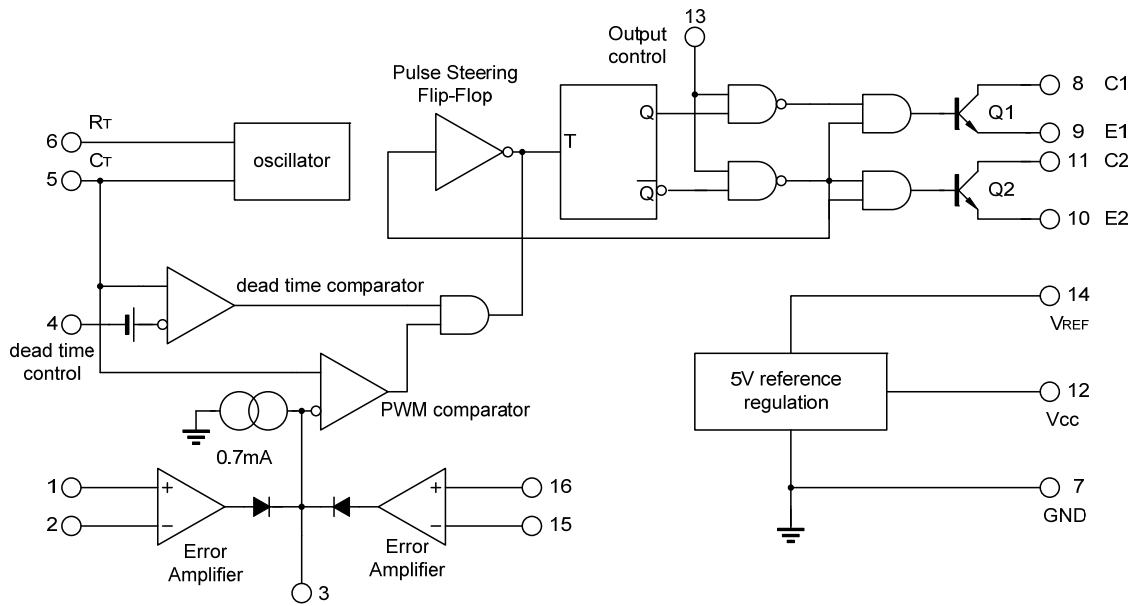

■ ABSOLUTE MAXIMUM RATINGS (unless otherwise specified)

PARAMETER	SYMBOL	RATINGS	UNIT
Supply Voltage(Note 3)	V_{CC}	41	V
Amplifier Input Voltage	V_{IN}	$V_{CC}+0.3$	V
Collector Output Voltage	V_{OUT}	41	V
Collector Output Current	I_{CO}	250	mA
Power Dissipation ($T_A=25^{\circ}C$)	P_D	1000	mW
Derate at $T_A > 25^{\circ}C$		9.2	mW/ $^{\circ}C$
Junction Temperature	T_J	125	$^{\circ}C$
Operating Temperature	T_{OPR}	-25 ~ +85	$^{\circ}C$
Storage Temperature	T_{STG}	-40 ~ +150	$^{\circ}C$

Notes: 1. Absolute maximum ratings are those values beyond which the device could be permanently damaged. Absolute maximum ratings are stress ratings only and functional device operation is not implied.
 2. All voltage values, except differential voltages are with respect to the network ground terminal.

■ RECOMMENDED OPERATING CONDITIONS

PARAMETER	SYMBOL	MIN	TYP	MAX	UNIT
Supply Voltage	V_{CC}	7		40	V
Amplifier Input Voltage	V_{IN}	-0.3		$V_{CC}-2$	V
Collector Output Voltage	V_{OUT}			40	V
Collector Output Current (each Transistor)	I_C			200	mA
Current into Feedback	I_f			0.3	mA
Timing Capacitor	C_T	0.47		10000	nF
Timing Resistor	R_T	1.8		500	k Ω
Oscillator Frequency	f_{OSC}	1		300	kHz
Operating Free-Air Temperature	T_A	0		+70	$^{\circ}C$

■ ELECTRICAL CHARACTERISTICS

(Over recommended operating free-air temperature range, $V_{CC}=15V$, $f=1kHz$, unless otherwise specified)

PARAMETER	SYMBOL	TEST CONDITIONS	MIN	TYP	MAX	UNIT
REFERENCE SECTION						
Output Voltage	V_{OUT}	$I_{OUT}=1mA$	4.75	5	5.25	V
Input Regulation	V_{IN}	$V_{CC}=7V \sim 40V$		2	25	mV
Output Regulation	V_{OUT}	$I_{OUT}=1 \sim 10mA$		1	15	mV
Output Voltage Change with Temperature		$\Delta T_A=MIN \sim MAX$ (note 2)		0.2	1	%
Short-Circuit Output Current	$I_{O(SC)}$	$V_{REF}=0$		35		mA
OSCILLATOR SECTION						
Frequency	F	$C_T=0.01\mu F, R_T=12k\Omega$		10		kHz
Standard Deviation of Frequency		All Values of V_{CC}, C_T, R_T, T_A constant		10		%
Frequency Change with Voltage		$V_{CC}=7V \sim 40V, T_A=25^{\circ}C$		0.1		%
Frequency Change with Temperature		$C_T=0.01\mu F, R_T=12k\Omega, \Delta T_A=MIN \sim MAX$			12	%

■ ELECTRICAL CHARACTERISTICS(Cont.)

PARAMETER		SYMBOL	TEST CONDITIONS	MIN	TYP	MAX	UNIT
AMPLIFIER SECTION							
Input Offset Voltage	Error	$V_{I(OFF)}$	$V_{OUT}(\text{pin } 3)=2.5V$		2	10	mV
Input Offset Current		$I_{I(OFF)}$	$V_{OUT}(\text{pin } 3)=2.5V$		25	250	nA
Input Bias Current		$I_{I(BIAS)}$	$V_{OUT}(\text{pin } 3)=2.5V$		0.2	1	μA
Common-Mode Input Voltage Range	Error		$V_{CC}=7V \sim 40V$	-0.3 ~ $V_{CC}-2$			V
Open-Loop Voltage Amplification			$\Delta V_{OUT}=3V, V_{OUT}=0.5V \sim 3.5V$	70	95		dB
Unity-Gain Bandwidth		GB_W			800		kHz
Common-Mode Rejection Ratio	Error	CMRR	$V_{CC}=40V, T_A=25^\circ C$	65	80		dB
Output Sink Current(pin 3)		$I_{O(SINK)}$	$V_{ID}=-15mV \sim -5V, V(\text{pin } 3)=0.5V$	0.3	0.7		mA
Output source Current(pin 3)		$I_{O(SOURCE)}$	$V_{ID}=15mV \sim -5V, V(\text{pin } 3)=3.5V$	-2			mA
OUTPUT SECTION							
Collector off-state current		$I_{C(OFF)}$	$V_{CE}=40V, V_{CC}=40V$		2	100	μA
Emitter off-state Current		$I_{E(OFF)}$	$V_{CC}=V_C=40V, V_E=0$			-100	μA
Collector -emitter Saturation Voltage	Common-emitter		$V_E=0, I_C=200mA$		1.1	1.3	V
	Emitter-Follower		$V_C=15V, I_E=-200mA$		1.5	2.5	
Output Control Input Current			$V_{IN}=V_{REF}$			3.5	mA
DEAD TIME CONTROL SECTION							
Input bias (pin 4)		$I_{I(BIAS)}$	$V_{IN}=0 \sim 5.25V$		-2	-10	μA
Maximum duty cycle, each output			$V_{IN}(\text{pin } 4)=0$	45			%
Input threshold Voltage(pin 4)		V_{THR}	Zero duty Cycle		3	3.3	V
			Maximum duty cycle	0			
PWM COMPARATOR SECTION							
Input Threshold Voltage(pin 3)		V_{THR}	Zero Duty cycle		4	4.5	V
Input Sink Current (pin 3)		$I_{I(SINK)}$	$V(\text{pin } 3)=0.7V$	0.3	0.7		mA
TOTAL DEVICE							
Standby Supply Current	$V_{CC}=15V$	I_{ST-BY}	pin 6 at V_{REF} , all other Inputs and outputs open		6	10	mA
	$V_{CC}=40V$				9	15	
Average supply current			$V(\text{pin } 4)=2V$		7.5		mA
SWITCHING CHARACTERISTICS, $T_A=25^\circ C$							
Output Voltage Rise Time		t_R	Common-emitter configuration		100	200	ns
Output Voltage Fall Time		t_F			25	100	ns
Output Voltage Rise Time		t_R	Emitter-follower configuration		100	200	ns
Output Voltage Fall Time		t_F			40	100	ns

Notes: 1. All typical Values except for temperature coefficient are at $T_A=25^\circ C$.

2. For conditions shown as MIN or MAX, use appropriate value under recommended operating conditions.

3. Duration of the short-circuit should not exceed one second

4. Standard deviation is a measure of the statistical distribution the mean as derived from the formula:

$$\sigma = \sqrt{\frac{\sum_{n=1}^N (x_n - \bar{x})^2}{N-1}}$$

■ TEST CIRCUIT (Cont.)

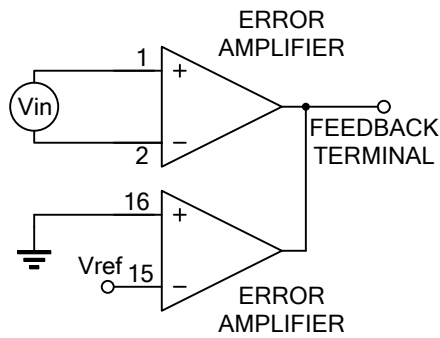

Fig. 2 AMPLIFIER CHARACTERISTICS

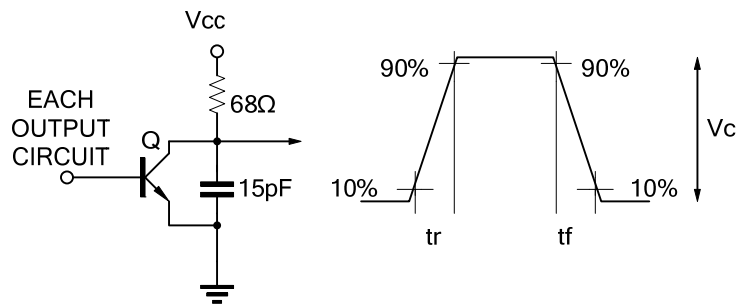

Fig. 3 COMMON-EMITTER CONFIGURATION

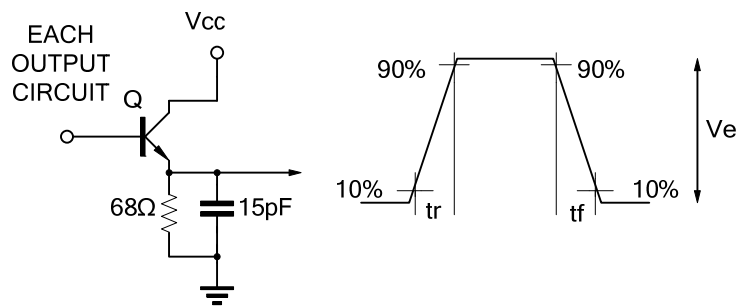
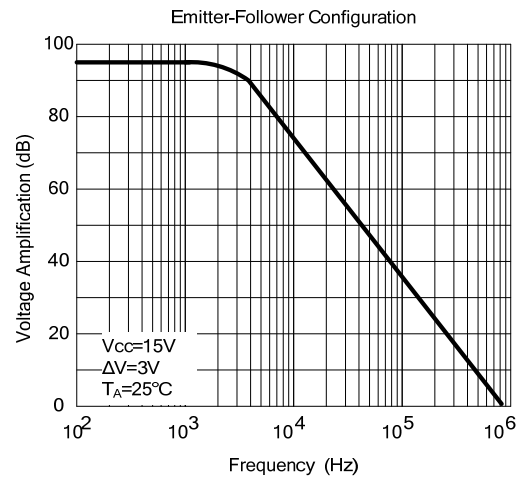
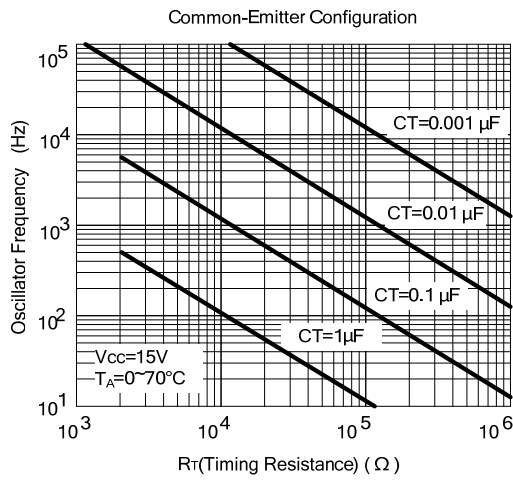

Fig. 4 EMITTER -FOLLOWER CONFIGURATION

■ TYPICAL CHARACTERISTICS



UTC assumes no responsibility for equipment failures that result from using products at values that exceed, even momentarily, rated values (such as maximum ratings, operating condition ranges, or other parameters) listed in products specifications of any and all UTC products described or contained herein. UTC products are not designed for use in life support appliances, devices or systems where malfunction of these products can be reasonably expected to result in personal injury. Reproduction in whole or in part is prohibited without the prior written consent of the copyright owner. UTC reserves the right to make changes to information published in this document, including without limitation specifications and product descriptions, at any time and without notice. This document supersedes and replaces all information supplied prior to the publication hereof.