

TLE214x, TLE214xA EXCALIBUR LOW-NOISE HIGH-SPEED PRECISION OPERATIONAL AMPLIFIERS

SLOS183D – FEBRUARY 1997 – REVISED OCTOBER 2012

- **Low Noise**
10 Hz . . . 15 nV/ $\sqrt{\text{Hz}}$
1 kHz . . . 10.5 nV/ $\sqrt{\text{Hz}}$
- **10000-pF Load Capability**
- **20-mA Min Short-Circuit Output Current**
- **27-V/ μs Min Slew Rate**
- **High Gain-Bandwidth Product . . . 5.9 MHz**
- **Low V_{IO} . . . 500 μV Max at 25°C**
- **Single or Split Supply . . . 4 V to 44 V**
- **Fast Settling Time**
340 ns to 0.1%
400 ns to 0.01%
- **Saturation Recovery . . . 150 ns**
- **Large Output Swing**
 $V_{CC-} + 0.1 \text{ V}$ to $V_{CC+} - 1 \text{ V}$

description

The TLE214x and TLE214xA devices are high-performance, internally compensated operational amplifiers built using Texas Instruments complementary bipolar Excalibur process. The TLE214xA is a tighter offset voltage grade of the TLE214x. Both are pin-compatible upgrades to standard industry products.

The design incorporates an input stage that simultaneously achieves low audio-band noise of 10.5 nV/ $\sqrt{\text{Hz}}$ with a 10-Hz 1/f corner and symmetrical 40-V/ μs slew rate typically with loads up to 800 pF. The resulting low distortion and high power bandwidth are important in high-fidelity audio applications. A fast settling time of 340 ns to 0.1% of a 10-V step with a 2-k Ω /100-pF load is useful in fast actuator/positioning drivers. Under similar test conditions, settling time to 0.01% is 400 ns.

The devices are stable with capacitive loads up to 10 nF, although the 6-MHz bandwidth decreases to 1.8 MHz at this high loading level. As such, the TLE214x and TLE214xA are useful for low-droop sample-and-holds and direct buffering of long cables, including 4-mA to 20-mA current loops.

The special design also exhibits an improved insensitivity to inherent integrated circuit component mismatches as is evidenced by a 500- μV maximum offset voltage and 1.7- $\mu\text{V}/^\circ\text{C}$ typical drift. Minimum common-mode rejection ratio and supply-voltage rejection ratio are 85 dB and 90 dB, respectively.

Device performance is relatively independent of supply voltage over the $\pm 2\text{-V}$ to $\pm 22\text{-V}$ range. Inputs can operate between $V_{CC-} - 0.3$ to $V_{CC+} - 1.8 \text{ V}$ without inducing phase reversal, although excessive input current may flow out of each input exceeding the lower common-mode input range. The all-npn output stage provides a nearly rail-to-rail output swing of $V_{CC-} - 0.1$ to $V_{CC+} - 1 \text{ V}$ under light current-loading conditions. The device can sustain shorts to either supply since output current is internally limited, but care must be taken to ensure that maximum package power dissipation is not exceeded.

Both versions can also be used as comparators. Differential inputs of $V_{CC\pm}$ can be maintained without damage to the device. Open-loop propagation delay with TTL supply levels is typically 200 ns. This gives a good indication as to output stage saturation recovery when the device is driven beyond the limits of recommended output swing.

Both the TLE214x and TLE214xA are available in a wide variety of packages, including both the industry-standard 8-pin small-outline version and chip form for high-density system applications. The C-suffix devices are characterized for operation from 0°C to 70°C, I-suffix devices from -40°C to 105°C, and M-suffix devices over the full military temperature range of -55°C to 125°C.



Please be aware that an important notice concerning availability, standard warranty, and use in critical applications of Texas Instruments semiconductor products and disclaimers thereto appears at the end of this data sheet.

PRODUCTION DATA information is current as of publication date. Products conform to specifications per the terms of Texas Instruments standard warranty. Production processing does not necessarily include testing of all parameters.

 **TEXAS
INSTRUMENTS**

POST OFFICE BOX 655303 • DALLAS, TEXAS 75265

Copyright © 1997 – 2006, Texas Instruments Incorporated

TLE214x, TLE214xA EXCALIBUR LOW-NOISE HIGH-SPEED PRECISION OPERATIONAL AMPLIFIERS

SLOS183D – FEBRUARY 1997 – REVISED OCTOBER 2012

TLE2141 AVAILABLE OPTIONS

T _A	V _{IO} max AT 25°C	PACKAGED DEVICES		
		SMALL OUT- LINE† (D)	CERAMIC DIP (JG)	PLASTIC DIP (P)
0°C to 70°C	500 µV 900 µV	TLE2141ACD TLE2141CD	—	TLE2141ACP TLE2141CP
-40°C to 105°C	500 µV 900 µV	TLE2141AID TLE2141ID	—	TLE2141AIP TLE2141IP
-55°C to 125°C	500 µV 900 µV	— TLE2141MD	TLE2141AMJG TLE2141MJG	— —

† The D packages are available taped and reeled. Add R suffix to device type (e.g., TLE2141ACDR).

TLE2142 AVAILABLE OPTIONS

PACKAGED DEVICES							
T _A	V _{IO} max AT 25°C	SMALL OUTLINE† (D)	CHIP CARRIER (FK)	CERAMIC DIP (JG)	PLASTIC DIP (P)	TSSOP‡ (PW)	CERAMIC FLAT PACK (U)
0°C to 70°C	750 µV 1200 µV	TLE2142ACD TLE2142CD	— —	— —	TLE2142ACP TLE2142CP	— TLE2142CPWLE	— —
-40°C to 105°C	750 µV 1200 µV	TLE2142AID TLE2142ID	— —	— —	TLC2142AIP TLC2142IP	— —	— —
-55°C to 125°C	750 µV 1200 µV	TLE2142AMD TLE2142MD	TLE2142AMFK TLE2142MFK	TLE2142AMJG TLE2142MJG	— —	— —	TLE2142AMU TLE2142MU

† The D packages are available taped and reeled. Add R suffix to device type (e.g., TLC2142ACDR).

‡ The PW packages are available left-ended taped and reeled. Add LE the suffix to device type (e.g., TLC2142CPWLE).

TLE2144 AVAILABLE OPTIONS

T _A	V _{IO} max AT 25°C	PACKAGED DEVICES			
		SMALL OUTLINE† (DW)	CHIP CARRIER (FK)	CERAMIC DIP (J)	PLASTIC DIP (N)
0°C to 70°C	1.5 mV 2.4 mV	— TLE2144CDW	— —	— —	TLE2144ACN TLE2144CN
-40°C to 105°C	1.5 mV 2.4 mV	— TLE2144IDW	— —	— —	TLE2144AIN TLE2144IN
-55°C to 125°C	1.5 mV 2.5 mV	— TLE2144MDW	TLE2144AMFK TLE2144MFK	TLE2144AMJ TLE2144MJ	— —

† The DW packages are available taped and reeled. Add R suffix to device type (e.g., TLE2144CDWR).

symbol

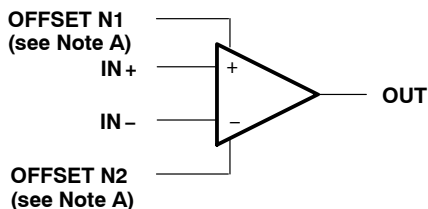

NOTES: A. OFFSET N1 AND OFFSET N2 are only available on the TLE2241x devices.

TLE214x, TLE214xA EXCALIBUR LOW-NOISE HIGH-SPEED PRECISION OPERATIONAL AMPLIFIERS

SLOS183D – FEBRUARY 1997 – REVISED OCTOBER 2012

TLE2141
D, JG, OR P PACKAGE
(TOP VIEW)



TLE2142
PW PACKAGE
(TOP VIEW)

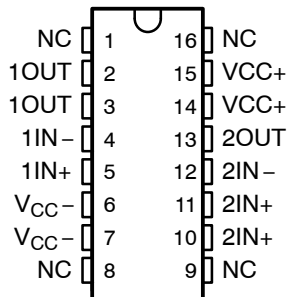

TLE2142
D, JG, OR P PACKAGE
(TOP VIEW)

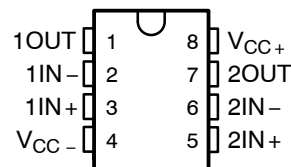

TLE2141
FK PACKAGE
(TOP VIEW)

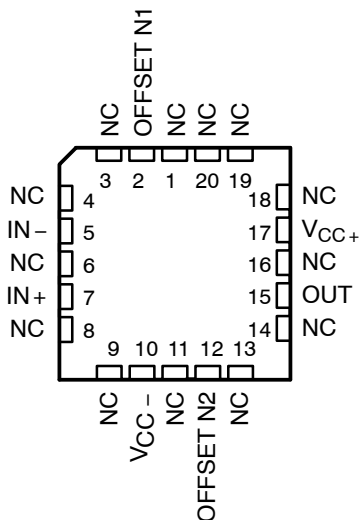

TLE2142
U PACKAGE
(TOP VIEW)

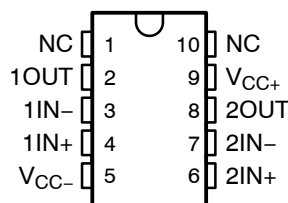

TLE2142
FK PACKAGE
(TOP VIEW)

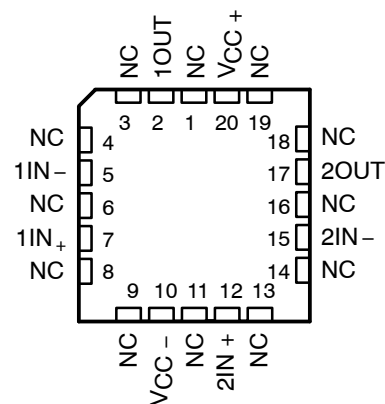

TLE2144
DW PACKAGE
(TOP VIEW)

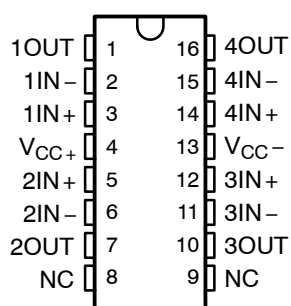

TLE2144
J OR N PACKAGE
(TOP VIEW)

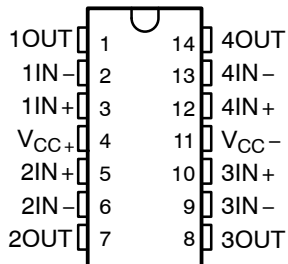

TLE2144
FK PACKAGE
(TOP VIEW)

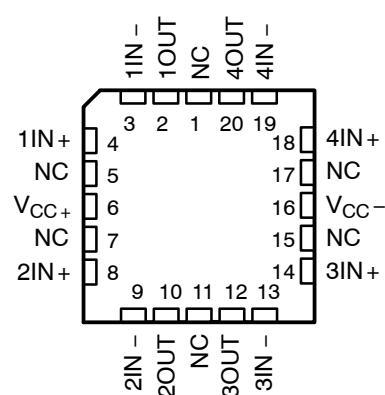

NC – No internal connection

equivalent schematic

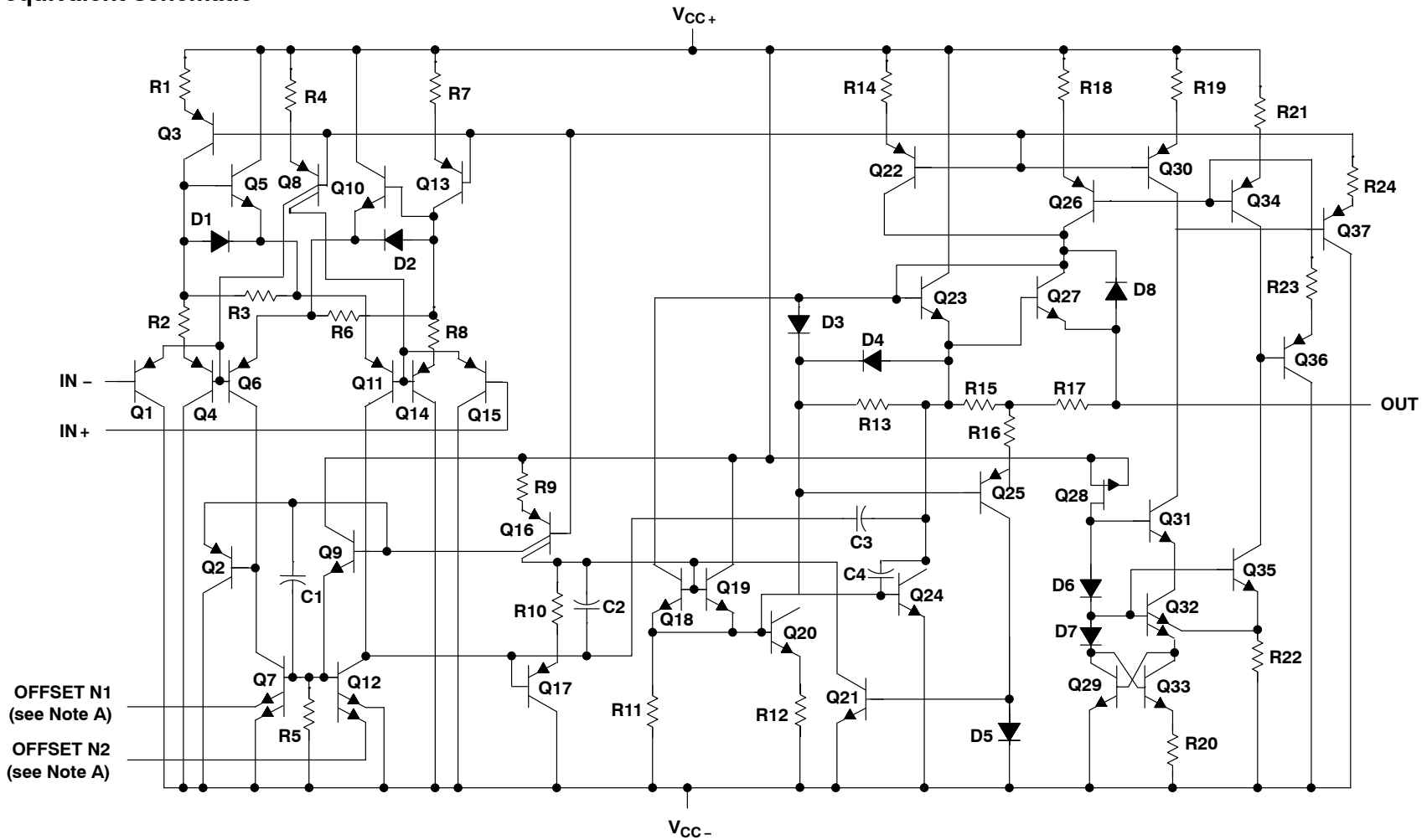

NOTE A: OFFSET N1 AND OFFSET N2 are only available on the TLE2141x devices.

ACTUAL DEVICE COMPONENT COUNT			
COMPONENT	TLE2141	TLE2142	TLE2144
Transistors	46	65	130
Resistors	24	43	86
Diodes	8	14	28
Capacitors	4	8	16
Epi-FET	1	1	2

TLE214X, TLE214XA, TLE214XY
 EXCALIBUR LOW-NOISE HIGH-SPEED
 PRECISION OPERATIONAL AMPLIFIERS
 SLOS183D - FEBRUARY 1997 - REVISED OCTOBER 2012

TLE214x, TLE214xA
EXCALIBUR LOW-NOISE HIGH-SPEED
PRECISION OPERATIONAL AMPLIFIERS

SLOS183D – FEBRUARY 1997 – REVISED OCTOBER 2012

absolute maximum ratings over operating free-air temperature range (unless otherwise noted)†

Supply voltage, V_{CC+} (see Note 1)	22 V	
Supply voltage, V_{CC-}	–22 V	
Differential input voltage, V_{ID} (see Note 2)	±44 V	
Input voltage range, V_I (any input)	V_{CC+} to V_{CC-} – 0.3 V	
Input current, I_I (each input)	±1 mA	
Output current, I_O	±80 mA	
Total current into V_{CC+}	80 mA	
Total current out of V_{CC-}	80 mA	
Duration of short-circuit current at (or below) 25°C (see Note 3)	unlimited	
Package thermal impedance, θ_{JA} (see Notes 4 and 5):	D package	97.1°C/W
	DW package	57.3°C/W
	N package	79.7°C/W
	P package	84.6°C/W
	PW package	108.4°C/W
Package thermal impedance, θ_{JC} (see Notes 4 and 5):	FK package	5.6°C/W
	J package	15.1°C/W
	JG package	14.5°C/W
	U package	14.7°C/W
Operating free-air temperature range, T_A : C suffix		0°C to 70°C
	I suffix	–40°C to 105°C
	M suffix	–55°C to 125°C
Storage temperature range	–65°C to 150°C	
Case temperature for 60 seconds: FK package	260°C	
Lead temperature 1,6 mm (1/16 inch) from case for 10 seconds: D, DW, N, P, or PW package	260°C	
Lead temperature 1,6 mm (1/16 inch) from case for 60 seconds: J or JG package	300°C	

† Stresses beyond those listed under “absolute maximum ratings” may cause permanent damage to the device. These are stress ratings only, and functional operation of the device at these or any other conditions beyond those indicated under “recommended operating conditions” is not implied. Exposure to absolute-maximum-rated conditions for extended periods may affect device reliability.

- NOTES:
1. All voltage values, except differential voltages, are with respect to the midpoint between V_{CC+} and V_{CC-} .
 2. Differential voltages are at $IN+$ with respect to $IN-$. Excessive current flows, if input, are brought below V_{CC-} – 0.3 V.
 3. The output may be shorted to either supply. Temperature and/or supply voltages must be limited to ensure that the maximum dissipation rating is not exceeded.
 4. Maximum power dissipation is a function of $T_J(\max)$, θ_{JA} , and T_A . The maximum allowable power dissipation at any allowable ambient temperature is $P_D = (T_J(\max) - T_A)/\theta_{JA}$. Operating at the absolute maximum T_J of 150°C can affect reliability.
 5. The package thermal impedance is calculated in accordance with JESD 51-7 (plastic) or MIL-STD-883 Method 1012 (ceramic).

recommended operating conditions

	C SUFFIX		I SUFFIX		M SUFFIX		UNIT
	MIN	MAX	MIN	MAX	MIN	MAX	
Supply voltage, $V_{CC\pm}$	±2	±22	±2	±22	±2	±22	V
Common-mode input voltage, V_{IC}	$V_{CC} = 5\text{ V}$		0	2.9	0	2.7	V
	$V_{CC\pm} = \pm 15\text{ V}$		–15	12.9	–15	12.7	
Operating free-air temperature, T_A	0	70	–40	105	–55	125	°C



TLE214x, TLE214xA EXCALIBUR LOW-NOISE HIGH-SPEED PRECISION OPERATIONAL AMPLIFIERS

SLOS183D – FEBRUARY 1997 – REVISED OCTOBER 2012

TLE2141C electrical characteristics at specified free-air temperature, $V_{CC} = 5\text{ V}$ (unless otherwise noted)

PARAMETER	TEST CONDITIONS	T_A^\dagger	TLE2141C			TLE2141AC			UNIT
			MIN	TYP	MAX	MIN	TYP	MAX	
V_{IO} Input offset voltage	$V_O = 2.5\text{ V}$ $V_{IC} = 2.5\text{ V}$ $R_S = 50\ \Omega$	25°C	225	1400		200	1000	μV	
		Full range			1700		1300		
α_{VIO} Temperature coefficient of input offset voltage		Full range		1.7			1.7	$\mu\text{V}/^\circ\text{C}$	
I_{IO} Input offset current		25°C	8	100		8	100	nA	
		Full range			150		150		
I_{IB} Input bias current		25°C	-0.8	-2		-0.8	-2	μA	
	Full range			-2.1		-2.1			
V_{ICR} Common-mode input voltage range	$R_S = 50\ \Omega$	25°C	0 to 3	-0.3 to 3.2		0 to 3	-0.3 to 3.2	V	
		Full range	0 to 2.9			0 to 2.9			
V_{OH} High-level output voltage	$I_{OH} = -150\ \mu\text{A}$	25°C	3.9	4.1		3.9	4.1	V	
		Full range			3.8		3.8		
	$I_{OH} = -1.5\text{ mA}$	25°C	3.8	4		3.8	4		
		Full range			3.7		3.7		
$I_{OH} = -15\text{ mA}$	25°C	3.2	3.7		3.2	3.7			
	Full range			3.2		3.2			
V_{OL} Low-level output voltage	$I_{OL} = 150\ \mu\text{A}$	25°C		75	125		75	125	mV
		Full range			150		150		
	$I_{OL} = 1.5\text{ mA}$	25°C		150	225		150	225	
		Full range			250		250		
	$I_{OL} = 15\text{ mA}$	25°C		1.2	1.6		1.2	1.6	V
		Full range			1.7		1.7		
A_{VD} Large-signal differential voltage amplification	$V_{CC} = \pm 2.5\text{ V}$, $R_L = 2\text{ k}\Omega$, $V_O = 1\text{ V to } -1.5\text{ V}$	25°C	50	220		50	220	V/mV	
		Full range			25		25		
r_i Input resistance		25°C		70		70	$\text{M}\Omega$		
c_i Input capacitance		25°C		2.5		2.5	pF		
z_o Open-loop output impedance	$f = 1\text{ MHz}$	25°C		30		30	Ω		
CMRR Common-mode rejection ratio	$V_{IC} = V_{ICRmin}$, $R_S = 50\ \Omega$	25°C	85	118		85	118	dB	
		Full range			80		80		
k_{SVR} Supply-voltage rejection ratio ($\Delta V_{CC\pm}/\Delta V_{IO}$)	$V_{CC\pm} = \pm 2.5\text{ V to } \pm 15\text{ V}$, $R_S = 50\ \Omega$	25°C	90	106		90	106	dB	
		Full range			85		85		
I_{CC} Supply current	$V_O = 2.5\text{ V}$, No load, $V_{IC} = 2.5\text{ V}$	25°C		3.4	4.4		3.4	4.4	mA
		Full range			4.6		4.6		

† Full range is 0°C to 70°C.



TLE214x, TLE214xA
EXCALIBUR LOW-NOISE HIGH-SPEED
PRECISION OPERATIONAL AMPLIFIERS

SLOS183D – FEBRUARY 1997 – REVISED OCTOBER 2012

TLE2141C operating characteristics, $V_{CC} = 5\text{ V}$, $T_A = 25^\circ\text{C}$

PARAMETER	TEST CONDITIONS	TLE2141C			TLE2141AC			UNIT
		MIN	TYP	MAX	MIN	TYP	MAX	
SR+	Positive slew rate	$A_{VD} = -1$, $C_L = 500\text{ pF}^\dagger$		$R_L = 2\text{ k}\Omega^\dagger$		45		V/ μs
SR-	Negative slew rate					42		
t_s	Settling time	$A_{VD} = -1$, 2.5-V step		To 0.1%		0.16		μs
				To 0.01%		0.22		
V_n	Equivalent input noise voltage	$R_S = 20\ \Omega$, $f = 10\text{ Hz}$		15		15		nV/ $\sqrt{\text{Hz}}$
		$R_S = 20\ \Omega$, $f = 1\text{ kHz}$		10.5		10.5		
$V_{N(PP)}$	Peak-to-peak equivalent input noise voltage	$f = 0.1\text{ Hz to }1\text{ Hz}$		0.48		0.48		μV
		$f = 0.1\text{ Hz to }10\text{ Hz}$		0.51		0.51		
I_n	Equivalent input noise current	$f = 10\text{ Hz}$		1.92		1.92		pA/ $\sqrt{\text{Hz}}$
		$f = 1\text{ kHz}$		0.5		0.5		
THD + N	Total harmonic distortion plus noise	$V_O = 1\text{ V to }3\text{ V}$, $A_{VD} = 2$		$R_L = 2\text{ k}\Omega^\dagger$, $f = 10\text{ kHz}$		0.0052%		0.0052%
B_1	Unity-gain bandwidth	$R_L = 2\text{ k}\Omega^\dagger$, $C_L = 100\text{ pF}^\dagger$		5.9		5.9		MHz
	Gain-bandwidth product	$R_L = 2\text{ k}\Omega^\dagger$, $f = 100\text{ kHz}$		5.8		5.8		MHz
B_{OM}	Maximum output-swing bandwidth	$V_{O(PP)} = 2\text{ V}$, $A_{VD} = 1$		$R_L = 2\text{ k}\Omega^\dagger$, $C_L = 100\text{ pF}^\dagger$		660		kHz
ϕ_m	Phase margin at unity gain	$R_L = 2\text{ k}\Omega^\dagger$, $C_L = 100\text{ pF}^\dagger$		57°		57°		

$^\dagger R_L$ and C_L terminated to 2.5 V.

TLE214x, TLE214xA EXCALIBUR LOW-NOISE HIGH-SPEED PRECISION OPERATIONAL AMPLIFIERS

SLOS183D – FEBRUARY 1997 – REVISED OCTOBER 2012

TLE2141C electrical characteristics at specified free-air temperature, $V_{CC\pm} = \pm 15\text{ V}$ (unless otherwise noted)

PARAMETER	TEST CONDITIONS	T_A^\dagger	TLE2141C			TLE2141AC			UNIT
			MIN	TYP	MAX	MIN	TYP	MAX	
V_{IO} Input offset voltage	$V_{IC} = 0,$ $V_O = 0$ $R_S = 50\ \Omega,$	25°C	200	900		175	500	μV	
		Full range			1300		800		
α_{VIO} Temperature coefficient of input offset voltage		Full range	1.7			1.7		$\mu\text{V}/^\circ\text{C}$	
I_{IO} Input offset current		25°C	7	100		7	100	nA	
		Full range			150		150		
I_{IB} Input bias current		25°C	-0.7	-1.5		-0.7	-1.5	μA	
	Full range			-1.6		-1.6			
V_{ICR} Common-mode input voltage range	$R_S = 50\ \Omega$	25°C	-15 to 13	-15.3 to 13.2		-15 to 13	-15.3 to 13.2	V	
		Full range	-15 to 12.9	-15.3 to 13.1		-15 to 12.9	-15.3 to 13.1		
V_{OM+} Maximum positive peak output voltage swing	$I_O = -150\ \mu\text{A}$	25°C	13.8	14.1		13.8	14.1	V	
		Full range	13.7			13.7			
	$I_O = -1.5\ \text{mA}$	25°C	13.7	14		13.7	14		
		Full range	13.6			13.6			
$I_O = -15\ \text{mA}$	25°C	13.1	13.7		13.1	13.7			
	Full range	13			13				
V_{OM-} Maximum negative peak output voltage swing	$I_O = 150\ \mu\text{A}$	25°C	-14.7	-14.9		-14.7	-14.9	V	
		Full range	-14.6			-14.6			
	$I_O = 1.5\ \text{mA}$	25°C	-14.5	-14.8		-14.5	-14.8		
		Full range	-14.4			-14.4			
$I_O = 15\ \text{mA}$	25°C	-13.4	-13.8		-13.4	-13.8			
	Full range	-13.3			-13.3				
A_{VD} Large-signal differential voltage amplification	$V_O = \pm 10\ \text{V}$	25°C	100	450		100	450	V/mV	
		Full range	75			75			
r_i Input resistance	$R_L = 2\ \text{k}\Omega$	25°C	65			65	$\text{M}\Omega$		
c_i Input capacitance		25°C	2.5			2.5	pF		
z_o Open-loop output impedance	$f = 1\ \text{MHz}$	25°C	30			30	Ω		
CMRR Common-mode rejection ratio	$V_{IC} = V_{ICRmin},$ $R_S = 50\ \Omega$	25°C	85	108		85	108	dB	
		Full range	80			80			
k_{SVR} Supply-voltage rejection ratio ($\Delta V_{CC\pm}/\Delta V_{IO}$)	$V_{CC\pm} = \pm 2.5\ \text{V to } \pm 15\ \text{V},$ $R_S = 50\ \Omega$	25°C	90	106		90	106	dB	
		Full range	85			85			
I_{OS} Short-circuit output current	$V_O = 0$	25°C	$V_{ID} = 1\ \text{V}$	-25	-50		-25	-50	mA
			$V_{ID} = -1\ \text{V}$	20	31		20	31	
I_{CC} Supply current	$V_O = 0,$ No load	25°C	3.5	4.5		3.5	4.5	mA	
		Full range			4.7		4.7		

† Full range is 0°C to 70°C.



TLE214x, TLE214xA
EXCALIBUR LOW-NOISE HIGH-SPEED
PRECISION OPERATIONAL AMPLIFIERS

SLOS183D – FEBRUARY 1997 – REVISED OCTOBER 2012

TLE2141C operating characteristics, $V_{CC\pm} = \pm 15\text{ V}$, $T_A = 25^\circ\text{C}$

PARAMETER	TEST CONDITIONS	TLE2141C			TLE2141AC			UNIT	
		MIN	TYP	MAX	MIN	TYP	MAX		
SR+	Positive slew rate	$A_{VD} = -1$, $C_L = 500\text{ pF}$		$R_L = 2\text{ k}\Omega$	27	45	27	45	V/ μs
SR-	Negative slew rate				27	42	27	42	
t_s	Settling time	$A_{VD} = -1$, 10-V step		To 0.1%	0.34			μs	
					To 0.01%	0.4			
V_n	Equivalent input noise voltage	$R_S = 20\ \Omega$, $f = 10\text{ Hz}$		15			nV/ $\sqrt{\text{Hz}}$		
		$R_S = 20\ \Omega$, $f = 1\text{ kHz}$		10.5					
$V_{N(PP)}$	Peak-to-peak equivalent input noise voltage	$f = 0.1\text{ Hz to }1\text{ Hz}$		0.48			μV		
		$f = 0.1\text{ Hz to }10\text{ Hz}$		0.51					
I_n	Equivalent input noise current	$f = 10\text{ Hz}$		1.89			pA/ $\sqrt{\text{Hz}}$		
		$f = 1\text{ kHz}$		0.47					
THD + N	Total harmonic distortion plus noise	$V_{O(PP)} = 20\text{ V}$, $A_{VD} = 10$		$R_L = 2\text{ k}\Omega$, $f = 10\text{ kHz}$	0.01%			0.01%	
B_1	Unity-gain bandwidth	$R_L = 2\text{ k}\Omega$	$C_L = 100\text{ pF}$		6			MHz	
	Gain-bandwidth product	$R_L = 2\text{ k}\Omega$, $f = 100\text{ kHz}$	$C_L = 100\text{ pF}$		5.9			MHz	
B_{OM}	Maximum output-swing bandwidth	$V_{O(PP)} = 20\text{ V}$, $A_{VD} = 1$		$R_L = 2\text{ k}\Omega$, $C_L = 100\text{ pF}$	668			kHz	
ϕ_m	Phase margin at unity gain	$R_L = 2\text{ k}\Omega$	$C_L = 100\text{ pF}$		58°			58°	



TLE214x, TLE214xA EXCALIBUR LOW-NOISE HIGH-SPEED PRECISION OPERATIONAL AMPLIFIERS

SLOS183D – FEBRUARY 1997 – REVISED OCTOBER 2012

TLE2142C electrical characteristics at specified free-air temperature, $V_{CC} = 5\text{ V}$ (unless otherwise noted)

PARAMETER	TEST CONDITIONS	T_A^\dagger	TLE2142C			TLE2142AC			UNIT
			MIN	TYP	MAX	MIN	TYP	MAX	
V_{IO} Input offset voltage	$V_O = 2.5\text{ V},$ $V_{IC} = 2.5\text{ V}$ $R_S = 50\ \Omega,$	25°C	220	1900		200	1500	μV	
		Full range		2200		1800			
α_{VIO} Temperature coefficient of input offset voltage		Full range	1.7			1.7		$\mu\text{V}/^\circ\text{C}$	
I_{IO} Input offset current		25°C	8	100		8	100	nA	
		Full range		150		150			
I_{IB} Input bias current		25°C	-0.8	-2		-0.8	-2	μA	
	Full range		-2.1		-2.1				
V_{ICR} Common-mode input voltage range	$R_S = 50\ \Omega$	25°C	0 to 3	-0.3 to 3.2		0 to 3	-0.3 to 3.2	V	
		Full range	0 to 2.9			0 to 2.9			
V_{OH} High-level output voltage	$I_{OH} = -150\ \mu\text{A}$	25°C	3.9	4.1		3.9	4.1	V	
		Full range	3.8			3.8			
	$I_{OH} = -1.5\text{ mA}$	25°C	3.8	4		3.8	4		
		Full range	3.7			3.7			
$I_{OH} = -15\text{ mA}$	25°C	3.4	3.7		3.4	3.7			
	Full range	3.4			3.4				
V_{OL} Low-level output voltage	$I_{OL} = 150\ \mu\text{A}$	25°C	75	125		75	125	mV	
		Full range		150		150			
	$I_{OL} = 1.5\text{ mA}$	25°C	150	225		150	225		
		Full range		250		250			
	$I_{OL} = 15\text{ mA}$	25°C	1.2	1.4		1.2	1.4	V	
		Full range		1.5		1.5			
A_{VD} Large-signal differential voltage amplification	$V_{CC} = \pm 2.5\text{ V},$ $R_L = 2\text{ k}\Omega,$ $V_O = 1\text{ V to } -1.5\text{ V}$	25°C	50	220		50	220	V/mV	
		Full range	25			25			
r_i Input resistance		25°C	70		70		$\text{M}\Omega$		
c_i Input capacitance		25°C	2.5		2.5		pF		
z_o Open-loop output impedance	$f = 1\text{ MHz}$	25°C	30		30		Ω		
CMRR Common-mode rejection ratio	$V_{IC} = V_{ICRmin},$ $R_S = 50\ \Omega$	25°C	85	118		85	118	dB	
		Full range	80			80			
k_{SVR} Supply-voltage rejection ratio ($\Delta V_{CC\pm}/\Delta V_{IO}$)	$V_{CC\pm} = \pm 2.5\text{ V to } \pm 15\text{ V},$ $R_S = 50\ \Omega$	25°C	90	106		90	106	dB	
		Full range	85			85			
I_{CC} Supply current	$V_O = 2.5\text{ V},$ $V_{IC} = 2.5\text{ V}$ No load,	25°C	6.6	8.8		6.6	8.8	mA	
		Full range		9.2		9.2			

† Full range is 0°C to 70°C.



TLE214x, TLE214xA
EXCALIBUR LOW-NOISE HIGH-SPEED
PRECISION OPERATIONAL AMPLIFIERS

SLOS183D – FEBRUARY 1997 – REVISED OCTOBER 2012

TLE2142C operating characteristics, $V_{CC} = 5\text{ V}$, $T_A = 25^\circ\text{C}$

PARAMETER	TEST CONDITIONS	TLE2142C			TLE2142AC			UNIT
		MIN	TYP	MAX	MIN	TYP	MAX	
SR+	Positive slew rate	$A_{VD} = -1$, $C_L = 500\text{ pF}$		$R_L = 2\text{ k}\Omega^\dagger$		45		V/ μs
SR-	Negative slew rate					42		
t_s	Settling time	$A_{VD} = -1$, 2.5-V step		To 0.1%		0.16		μs
				To 0.01%		0.22		
V_n	Equivalent input noise voltage	$R_S = 20\ \Omega$, $f = 10\text{ Hz}$		15		15		nV/ $\sqrt{\text{Hz}}$
		$R_S = 20\ \Omega$, $f = 1\text{ kHz}$		10.5		10.5		
$V_{N(PP)}$	Peak-to-peak equivalent input noise voltage	$f = 0.1\text{ Hz to }1\text{ Hz}$		0.48		0.48		μV
		$f = 0.1\text{ Hz to }10\text{ Hz}$		0.51		0.51		
I_n	Equivalent input noise current	$f = 10\text{ Hz}$		1.92		1.92		pA/ $\sqrt{\text{Hz}}$
		$f = 1\text{ kHz}$		0.5		0.5		
THD + N	Total harmonic distortion plus noise	$V_O = 1\text{ V to }3\text{ V}$, $A_{VD} = 2$, $R_L = 2\text{ k}\Omega^\dagger$, $f = 10\text{ kHz}$		0.0052%		0.0052%		
B1	Unity-gain bandwidth	$R_L = 2\text{ k}\Omega^\dagger$	$C_L = 100\text{ pF}$	5.9		5.9		MHz
	Gain-bandwidth product	$R_L = 2\text{ k}\Omega^\dagger$, $f = 100\text{ kHz}$	$C_L = 100\text{ pF}$	5.8		5.8		MHz
B_{OM}	Maximum output-swing bandwidth	$V_{O(PP)} = 2\text{ V}$, $A_{VD} = 1$,	$R_L = 2\text{ k}\Omega^\dagger$, $C_L = 100\text{ pF}$	660		660		kHz
ϕ_m	Phase margin at unity gain	$R_L = 2\text{ k}\Omega^\dagger$	$C_L = 100\text{ pF}$	57°		57°		

$^\dagger R_L$ terminates at 2.5 V.

TLE214x, TLE214xA EXCALIBUR LOW-NOISE HIGH-SPEED PRECISION OPERATIONAL AMPLIFIERS

SLOS183D – FEBRUARY 1997 – REVISED OCTOBER 2012

TLE2142C electrical characteristics at specified free-air temperature, $V_{CC\pm} = \pm 15\text{ V}$ (unless otherwise noted)

PARAMETER	TEST CONDITIONS	T_A^\dagger	TLE2142C			TLE2142AC			UNIT
			MIN	TYP	MAX	MIN	TYP	MAX	
V_{IO} Input offset voltage	$V_{IC} = 0,$ $V_O = 0$ $R_S = 50\ \Omega,$	25°C	290	1200		275	750	μV	
		Full range		1600		1200			
α_{VIO} Temperature coefficient of input offset voltage		Full range	1.7			1.7		$\mu\text{V}/^\circ\text{C}$	
I_{IO} Input offset current		25°C	7	100		7	100	nA	
		Full range		150		150			
I_{IB} Input bias current		25°C	-0.7	-1.5		-0.7	-1.5	μA	
	Full range		-1.6		-1.6				
V_{ICR} Common-mode input voltage range	$R_S = 50\ \Omega$	25°C	-15 to 13	-15.3 to 13.2		-15 to 13	-15.3 to 13.2	V	
		Full range	-15 to 12.9	-15.3 to 13.1		-15 to 12.9	-15.3 to 13.1		
V_{OM+} Maximum positive peak output voltage swing	$I_O = -150\ \mu\text{A}$	25°C	13.8	14.1		13.8	14.1	V	
		Full range	13.7			13.7			
	$I_O = -1.5\ \text{mA}$	25°C	13.7	14		13.7	14		
		Full range	13.6			13.6			
V_{OM-} Maximum negative peak output voltage swing	$I_O = 150\ \mu\text{A}$	25°C	-14.7	-14.9		-14.7	-14.9	V	
		Full range	-14.6			-14.6			
	$I_O = 1.5\ \text{mA}$	25°C	-14.5	-14.8		-14.5	-14.8		
		Full range	-14.4			-14.4			
$I_O = 15\ \text{mA}$	25°C	-13.4	-13.8		-13.4	-13.8			
	Full range	-13.3			-13.3				
A_{VD} Large-signal differential voltage amplification	$V_O = \pm 10\ \text{V}$	25°C	100	450		100	450	V/mV	
		Full range	75			75			
r_i Input resistance	$R_L = 2\ \text{k}\Omega$	25°C	65			65	$\text{M}\Omega$		
c_i Input capacitance		25°C	2.5			2.5	pF		
z_o Open-loop output impedance	$f = 1\ \text{MHz}$	25°C	30			30	Ω		
CMRR Common-mode rejection ratio	$V_{IC} = V_{ICRmin},$ $R_S = 50\ \Omega$	25°C	85	108		85	108	dB	
		Full range	80			80			
k_{SVR} Supply-voltage rejection ratio ($\Delta V_{CC\pm}/\Delta V_{IO}$)	$V_{CC\pm} = \pm 2.5\ \text{V to } \pm 15\ \text{V},$ $R_S = 50\ \Omega$	25°C	90	106		90	106	dB	
		Full range	85			85			
I_{OS} Short-circuit output current	$V_O = 0$	25°C	$V_{ID} = 1\ \text{V}$	-25	-50		-25	-50	mA
			$V_{ID} = -1\ \text{V}$	20	31		20	31	
I_{CC} Supply current	$V_O = 0,$ No load	25°C	6.9	9		6.9	9	mA	
		Full range		9.4		9.4			

† Full range is 0°C to 70°C.



TLE214x, TLE214xA
EXCALIBUR LOW-NOISE HIGH-SPEED
PRECISION OPERATIONAL AMPLIFIERS

SLOS183D – FEBRUARY 1997 – REVISED OCTOBER 2012

TLE2142C operating characteristics, $V_{CC\pm} = \pm 15\text{ V}$, $T_A = 25^\circ\text{C}$

PARAMETER		TEST CONDITIONS		TLE2142C			TLE2142AC			UNIT
				MIN	TYP	MAX	MIN	TYP	MAX	
SR+	Positive slew rate	$A_{VD} = -1$, $C_L = 500\text{ pF}$	$R_L = 2\text{ k}\Omega$	27	45		27	45		V/ μs
SR-	Negative slew rate			27	42		27	42		
t_s	Settling time	$A_{VD} = -1$, 10-V step	To 0.1%	0.34			0.34			μs
			To 0.01%	0.4			0.4			
V_n	Equivalent input noise voltage	$R_S = 20\ \Omega$	$f = 10\text{ Hz}$	15			15			nV/ $\sqrt{\text{Hz}}$
			$f = 1\text{ kHz}$	10.5			10.5			
$V_{N(PP)}$	Peak-to-peak equivalent input noise voltage	$f = 0.1\text{ Hz to }1\text{ Hz}$		0.48			0.48			μV
		$f = 0.1\text{ Hz to }10\text{ Hz}$		0.51			0.51			
I_n	Equivalent input noise current	$f = 10\text{ Hz}$		1.89			1.89			pA/ $\sqrt{\text{Hz}}$
		$f = 1\text{ kHz}$		0.47			0.47			
THD + N	Total harmonic distortion plus noise	$V_{O(PP)} = 20\text{ V}$, $A_{VD} = 10$,	$R_L = 2\text{ k}\Omega$, $f = 10\text{ kHz}$	0.01%			0.01%			
B_1	Unity-gain bandwidth	$R_L = 2\text{ k}\Omega$,	$C_L = 100\text{ pF}$	6			6			MHz
	Gain-bandwidth product	$R_L = 2\text{ k}\Omega$, $f = 100\text{ kHz}$	$C_L = 100\text{ pF}$,	5.9			5.9			MHz
B_{OM}	Maximum output-swing bandwidth	$V_{O(PP)} = 20\text{ V}$, $A_{VD} = 1$,	$R_L = 2\text{ k}\Omega$, $C_L = 100\text{ pF}$	668			668			kHz
ϕ_m	Phase margin at unity gain	$R_L = 2\text{ k}\Omega$,	$C_L = 100\text{ pF}$	58°			58°			

TLE214x, TLE214xA EXCALIBUR LOW-NOISE HIGH-SPEED PRECISION OPERATIONAL AMPLIFIERS

SLOS183D – FEBRUARY 1997 – REVISED OCTOBER 2012

TLE2144C electrical characteristics at specified free-air temperature, $V_{CC} = 5\text{ V}$ (unless otherwise noted)

PARAMETER	TEST CONDITIONS	T_A^\dagger	TLE2144C			TLE2144AC			UNIT
			MIN	TYP	MAX	MIN	TYP	MAX	
V_{IO} Input offset voltage	$V_O = 2.5\text{ V}$, $V_{IC} = 2.5\text{ V}$ $R_S = 50\ \Omega$	25°C	0.5	3.8		0.5	3	mV	
		Full range			4.4		3.6		
α_{VIO} Temperature coefficient of input offset voltage		Full range		1.7			1.7	$\mu\text{V}/^\circ\text{C}$	
I_{IO} Input offset current		25°C	8	100		8	100	nA	
		Full range			150		150		
I_{IB} Input bias current		25°C	-0.8	-2		-0.8	-2	μA	
	Full range			-2.1		-2.1			
V_{ICR} Common-mode input voltage range	$R_S = 50\ \Omega$	25°C	0 to 3	-0.3 to 3.2		0 to 3	-0.3 to 3.2	V	
		Full range	0 to 2.9			0 to 2.9			
V_{OH} High-level output voltage	$I_{OH} = -150\ \mu\text{A}$	25°C	3.9	4.1		3.9	4.1	V	
		Full range	3.8			3.8			
	$I_{OH} = -1.5\text{ mA}$	25°C	3.8	4		3.8	4		
		Full range	3.7			3.7			
	$I_{OH} = -15\text{ mA}$	25°C	3.4	3.7		3.4	3.7		
		Full range	3.4			3.4			
V_{OL} Low-level output voltage	$I_{OL} = 150\ \mu\text{A}$	25°C		75	125		75	125	mV
		Full range			150		150		
	$I_{OL} = 1.5\text{ mA}$	25°C		150	225		150	225	
		Full range			250		250		
	$I_{OL} = 15\text{ mA}$	25°C		1.2	1.6		1.2	1.6	V
		Full range			1.7		1.7		
A_{VD} Large-signal differential voltage amplification	$V_{CC} = \pm 2.5\text{ V}$, $V_O = 1\text{ V to } -1.5\text{ V}$ $R_L = 2\text{ k}\Omega$	25°C	50	95		50	95	V/mV	
		Full range	25			25			
r_i Input resistance		25°C		70		70	$\text{M}\Omega$		
c_i Input capacitance		25°C		2.5		2.5	pF		
z_o Open-loop output impedance	$f = 1\text{ MHz}$	25°C		30		30	Ω		
CMRR Common-mode rejection ratio	$V_{IC} = V_{ICRmin}$, $R_S = 50\ \Omega$	25°C	85	118		85	118	dB	
		Full range	80			80			
k_{SVR} Supply-voltage rejection ratio ($\Delta V_{CC\pm}/\Delta V_{IO}$)	$V_{CC\pm} = \pm 2.5\text{ V to } \pm 15\text{ V}$, $R_S = 50\ \Omega$	25°C	90	106		90	106	dB	
		Full range	85			85			
I_{CC} Supply current	$V_O = 2.5\text{ V}$, $V_{IC} = 2.5\text{ V}$ No load,	25°C	13.2	17.6		13.2	17.6	mA	
		Full range			18.5		18.5		

† Full range is 0°C to 70°C.



TLE214x, TLE214xA
EXCALIBUR LOW-NOISE HIGH-SPEED
PRECISION OPERATIONAL AMPLIFIERS

SLOS183D – FEBRUARY 1997 – REVISED OCTOBER 2012

TLE2144C operating characteristics, $V_{CC} = 5\text{ V}$, $T_A = 25^\circ\text{C}$

PARAMETER	TEST CONDITIONS	TLE2144C			TLE2144AC			UNIT
		MIN	TYP	MAX	MIN	TYP	MAX	
SR+	Positive slew rate	$A_{VD} = -1$, $C_L = 500\text{ pF}$		$R_L = 2\text{ k}\Omega^\dagger$		45		V/ μs
SR-	Negative slew rate					42		
t_s	Settling time	$A_{VD} = -1$, 2.5-V step	To 0.1%		0.16		μs	
			To 0.01%		0.22			
V_n	Equivalent input noise voltage	$R_S = 20\ \Omega$, $f = 10\text{ Hz}$		15		nV/ $\sqrt{\text{Hz}}$		
		$R_S = 20\ \Omega$, $f = 1\text{ kHz}$		10.5				
$V_{N(PP)}$	Peak-to-peak equivalent input noise voltage	$f = 0.1\text{ Hz to }1\text{ Hz}$		0.48		μV		
		$f = 0.1\text{ Hz to }10\text{ Hz}$		0.51				
I_n	Equivalent input noise current	$f = 10\text{ Hz}$		1.92		pA/ $\sqrt{\text{Hz}}$		
		$f = 1\text{ kHz}$		0.5				
THD + N	Total harmonic distortion plus noise	$V_O = 1\text{ V to }3\text{ V}$, $A_{VD} = 2$,	$R_L = 2\text{ k}\Omega^\dagger$, $f = 10\text{ kHz}$		0.0052%		0.0052%	
B_1	Unity-gain bandwidth	$R_L = 2\text{ k}\Omega^\dagger$,	$C_L = 100\text{ pF}$		5.9		MHz	
	Gain-bandwidth product	$R_L = 2\text{ k}\Omega^\dagger$, $f = 100\text{ kHz}$	$C_L = 100\text{ pF}$		5.8		MHz	
B_{OM}	Maximum output-swing bandwidth	$V_{O(PP)} = 2\text{ V}$, $A_{VD} = 1$,	$R_L = 2\text{ k}\Omega^\dagger$, $C_L = 100\text{ pF}$		660		kHz	
ϕ_m	Phase margin at unity gain	$R_L = 2\text{ k}\Omega^\dagger$,	$C_L = 100\text{ pF}$		57°		57°	

$^\dagger R_L$ terminates at 2.5 V

TLE214x, TLE214xA EXCALIBUR LOW-NOISE HIGH-SPEED PRECISION OPERATIONAL AMPLIFIERS

SLOS183D – FEBRUARY 1997 – REVISED OCTOBER 2012

TLE2144C electrical characteristics at specified free-air temperature, $V_{CC\pm} = \pm 15\text{ V}$ (unless otherwise noted)

PARAMETER	TEST CONDITIONS	T_A^\dagger	TLE2144C			TLE2144AC			UNIT
			MIN	TYP	MAX	MIN	TYP	MAX	
V_{IO} Input offset voltage	$V_{IC} = 0,$ $V_O = 0$ $R_S = 50\ \Omega,$	25°C	0.6	2.4		0.5	1.5	mV	
		Full range			3.2		2.4		
α_{VIO} Temperature coefficient of input offset voltage		Full range	1.7			1.7		$\mu\text{V}/^\circ\text{C}$	
I_{IO} Input offset current		25°C	7	100		7	100	nA	
		Full range			150		150		
I_{IB} Input bias current		25°C	-0.7	-1.5		-0.7	-1.5	μA	
	Full range			-1.6		-1.6			
V_{ICR} Common-mode input voltage range	$R_S = 50\ \Omega$	25°C	-15 to 13	-15.3 to 13.2		-15 to 13	-15.3 to 13.2	V	
		Full range	-15 to 12.9	-15.3 to 13.1		-15 to 12.9	-15 to 13.1		
V_{OM+} Maximum positive peak output voltage swing	$I_O = -150\ \mu\text{A}$	25°C	13.8	14.1		13.8	14.1	V	
		Full range			13.7		13.7		
	$I_O = -1.5\ \text{mA}$	25°C	13.7	14		13.7	14		
		Full range			13.6		13.6		
	$I_O = -15\ \text{mA}$	25°C	13.1	13.7		13.1	13.7		
		Full range			13		13		
V_{OM-} Maximum negative peak output voltage swing	$I_O = 150\ \mu\text{A}$	25°C	-14.7	-14.9		-14.7	-14.9	V	
		Full range			-14.6		-14.6		
	$I_O = 1.5\ \text{mA}$	25°C	-14.5	-14.8		-14.5	-14.8		
		Full range			-14.4		-14.4		
	$I_O = 15\ \text{mA}$	25°C	-13.4	-13.8		-13.4	-13.8		
		Full range			-13.3		-13.3		
A_{VD} Large-signal differential voltage amplification	$V_O = \pm 10\ \text{V}$	25°C	100	170		100	170	V/mV	
		Full range			75		75		
r_i Input resistance	$R_L = 2\ \text{k}\Omega$	25°C		65		65	$\text{M}\Omega$		
c_i Input capacitance		25°C		2.5		2.5	pF		
z_o Open-loop output impedance	$f = 1\ \text{MHz}$	25°C		30		30	Ω		
CMRR Common-mode rejection ratio	$V_{IC} = V_{ICRmin},$ $R_S = 50\ \Omega$	25°C	85	108		85	108	dB	
		Full range			80		80		
k_{SVR} Supply-voltage rejection ratio ($\Delta V_{CC\pm}/\Delta V_{IO}$)	$V_{CC\pm} = \pm 2.5\ \text{V to } \pm 15\ \text{V},$ $R_S = 50\ \Omega$	25°C	90	106		90	106	dB	
		Full range			85		85		
I_{OS} Short-circuit output current	$V_O = 0$	25°C	$V_{ID} = 1\ \text{V}$	-25	-50		-25	-50	mA
			$V_{ID} = -1\ \text{V}$	20	31		20	31	
I_{CC} Supply current	$V_O = 0,$ No load	25°C		13.8	18		13.8	18	mA
		Full range			18.8		18.8		

† Full range is 0°C to 70°C.



TLE214x, TLE214xA
EXCALIBUR LOW-NOISE HIGH-SPEED
PRECISION OPERATIONAL AMPLIFIERS

SLOS183D – FEBRUARY 1997 – REVISED OCTOBER 2012

TLE2144C operating characteristics, $V_{CC\pm} = \pm 15\text{ V}$, $T_A = 25^\circ\text{C}$

PARAMETER	TEST CONDITIONS	TLE2144C			TLE2144AC			UNIT
		MIN	TYP	MAX	MIN	TYP	MAX	
SR+	Positive slew rate	$A_{VD} = -1$, $R_L = 2\text{ k}\Omega$, $C_L = 500\text{ pF}$		27	45	27	45	V/ μs
SR-	Negative slew rate			27	42	27	42	
t_s	Settling time	$A_{VD} = -1$, 10-V step	To 0.1%	0.34		0.34		μs
			To 0.01%	0.4		0.4		
V_n	Equivalent input noise voltage	$R_S = 20\ \Omega$, $f = 10\text{ Hz}$	15		15		nV/ $\sqrt{\text{Hz}}$	
		$R_S = 20\ \Omega$, $f = 1\text{ kHz}$	10.5		10.5			
$V_{N(PP)}$	Peak-to-peak equivalent input noise voltage	$f = 0.1\text{ Hz to }1\text{ Hz}$	0.48		0.48		μV	
		$f = 0.1\text{ Hz to }10\text{ Hz}$	0.51		0.51			
I_n	Equivalent input noise current	$f = 10\text{ Hz}$	1.89		1.89		pA/ $\sqrt{\text{Hz}}$	
		$f = 1\text{ kHz}$	0.47		0.47			
THD + N	Total harmonic distortion plus noise	$V_{O(PP)} = 20\text{ V}$, $A_{VD} = 10$,	$R_L = 2\text{ k}\Omega$, $f = 10\text{ kHz}$	0.01%		0.01%		
B_1	Unity-gain bandwidth	$R_L = 2\text{ k}\Omega$,	$C_L = 100\text{ pF}$	6		6		MHz
	Gain-bandwidth product	$R_L = 2\text{ k}\Omega$, $f = 100\text{ kHz}$	$C_L = 100\text{ pF}$,	5.9		5.9		MHz
B_{OM}	Maximum output-swing bandwidth	$V_{O(PP)} = 20\text{ V}$, $A_{VD} = 1$,	$R_L = 2\text{ k}\Omega$, $C_L = 100\text{ pF}$	668		668		kHz
ϕ_m	Phase margin at unity gain	$R_L = 2\text{ k}\Omega$,	$C_L = 100\text{ pF}$	58°		58°		



TLE214x, TLE214xA EXCALIBUR LOW-NOISE HIGH-SPEED PRECISION OPERATIONAL AMPLIFIERS

SLOS183D – FEBRUARY 1997 – REVISED OCTOBER 2012

TLE2141I electrical characteristics at specified free-air temperature, $V_{CC} = 5\text{ V}$ (unless otherwise noted)

PARAMETER	TEST CONDITIONS	T_A^\dagger	TLE2141I			TLE2141AI			UNIT
			MIN	TYP	MAX	MIN	TYP	MAX	
V_{IO} Input offset voltage	$V_O = 2.5\text{ V}$, $V_{IC} = 2.5\text{ V}$	25°C	225	1400		200	1000	μV	
		Full range			1900		1500		
α_{VIO} Temperature coefficient of input offset voltage		Full range	1.7			1.7		$\mu\text{V}/^\circ\text{C}$	
I_{IO} Input offset current		25°C	8	100		8	100	nA	
		Full range			200		200		
I_{IB} Input bias current		25°C	-0.8	-2		-0.8	-2	μA	
	Full range			-2.2		-2.2			
V_{ICR} Common-mode input voltage range	$R_S = 50\ \Omega$	25°C	0 to 3	-0.3 to 3.2		0 to 3	-0.3 to 3.2	V	
		Full range	0 to 2.7	-0.3 to 2.9		0 to 2.7	-0.3 to 2.9		
V_{OH} High-level output voltage	$I_{OH} = -150\ \mu\text{A}$	25°C	3.9	4.1		3.9	4.1	V	
	$I_{OH} = -1.5\text{ mA}$		3.8	4		3.8	4		
	$I_{OH} = -15\text{ mA}$	Full range	3.2	3.7		3.2	3.7		
	$I_{OH} = -100\ \mu\text{A}$		3.8			3.8			
	$I_{OH} = -1\text{ mA}$		3.7			3.7			
	$I_{OH} = -10\text{ mA}$		3.3			3.3			
V_{OL} Low-level output voltage	$I_{OL} = 150\ \mu\text{A}$	25°C	75	125		75	125	mV	
	$I_{OL} = 1.5\ \mu\text{A}$		150	225		150	225		
	$I_{OL} = 15\text{ mA}$	Full range	1.2	1.6		1.2	1.6	V	
	$I_{OL} = 100\ \mu\text{A}$		175			175			
	$I_{OL} = 1\text{ mA}$		225			225			
	$I_{OL} = 10\text{ mA}$		1.4			1.4			
A_{VD} Large-signal differential voltage amplification	$V_{CC} = \pm 2.5\text{ V}$, $R_L = 2\text{ k}\Omega$, $V_O = 1\text{ V to } -1.5\text{ V}$	25°C	50	220		50	220	V/mV	
		Full range	10			10			
r_i Input resistance		25°C	70			70	$\text{M}\Omega$		
c_i Input capacitance		25°C	2.5			2.5	pF		
z_o Open-loop output impedance	$f = 1\text{ MHz}$	25°C	30			30	Ω		
CMRR Common-mode rejection ratio	$V_{IC} = V_{ICRmin}$, $R_S = 50\ \Omega$	25°C	85	118		85	118	dB	
		Full range	80			80			
k_{SVR} Supply-voltage rejection ratio ($\Delta V_{CC\pm}/\Delta V_{IO}$)	$V_{CC\pm} = \pm 2.5\text{ V to } \pm 15\text{ V}$, $R_S = 50\ \Omega$	25°C	90	106		90	106	dB	
		Full range	85			85			
I_{CC} Supply current	$V_O = 2.5\text{ V}$, $V_{IC} = 2.5\text{ V}$	25°C	3.4	4.4		3.4	4.4	mA	
		Full range			4.6		4.6		

† Full range is -40°C to 105°C .



TLE214x, TLE214xA
EXCALIBUR LOW-NOISE HIGH-SPEED
PRECISION OPERATIONAL AMPLIFIERS

SLOS183D – FEBRUARY 1997 – REVISED OCTOBER 2012

TLE2141I operating characteristics, $V_{CC} = 5\text{ V}$, $T_A = 25^\circ\text{C}$

PARAMETER	TEST CONDITIONS	TLE2141I			TLE2141AI			UNIT
		MIN	TYP	MAX	MIN	TYP	MAX	
SR+	Positive slew rate	$A_{VD} = -1$, $C_L = 500\text{ pF}$		$R_L = 2\text{ k}\Omega^\dagger$		45		V/ μs
SR-	Negative slew rate					42		
t_s	Settling time	$A_{VD} = -1$, 2.5-V step		To 0.1%		0.16		μs
				To 0.01%		0.22		
V_n	Equivalent input noise voltage	$R_S = 20\ \Omega$, $f = 10\text{ Hz}$		15		15		nV/ $\sqrt{\text{Hz}}$
		$R_S = 20\ \Omega$, $f = 1\text{ kHz}$		10.5		10.5		
$V_{N(PP)}$	Peak-to-peak equivalent input noise voltage	$f = 0.1\text{ Hz to }1\text{ Hz}$		0.48		0.48		μV
		$f = 0.1\text{ Hz to }10\text{ Hz}$		0.51		0.51		
I_n	Equivalent input noise current	$f = 10\text{ Hz}$		1.92		1.92		pA/ $\sqrt{\text{Hz}}$
		$f = 1\text{ kHz}$		0.5		0.5		
THD + N	Total harmonic distortion plus noise	$V_O = 1\text{ V to }3\text{ V}$, $A_{VD} = 2$		$R_L = 2\text{ k}\Omega^\dagger$, $f = 10\text{ kHz}$		0.0052%		0.0052%
B_1	Unity-gain bandwidth	$R_L = 2\text{ k}\Omega^\dagger$, $C_L = 100\text{ pF}^\dagger$		5.9		5.9		MHz
	Gain-bandwidth product	$R_L = 2\text{ k}\Omega^\dagger$, $f = 100\text{ kHz}$		5.8		5.8		MHz
B_{OM}	Maximum output-swing bandwidth	$V_{O(PP)} = 2\text{ V}$, $A_{VD} = 1$		$R_L = 2\text{ k}\Omega^\dagger$, $C_L = 100\text{ pF}^\dagger$		660		kHz
ϕ_m	Phase margin at unity gain	$R_L = 2\text{ k}\Omega^\dagger$, $C_L = 100\text{ pF}^\dagger$		57°		57°		

[†] R_L and C_L terminated to 2.5 V.

TLE214x, TLE214xA EXCALIBUR LOW-NOISE HIGH-SPEED PRECISION OPERATIONAL AMPLIFIERS

SLOS183D – FEBRUARY 1997 – REVISED OCTOBER 2012

TLE2141I electrical characteristics at specified free-air temperature, $V_{CC\pm} = \pm 15\text{ V}$ (unless otherwise noted)

PARAMETER	TEST CONDITIONS	T_A^\dagger	TLE2141I			TLE2141AI			UNIT
			MIN	TYP	MAX	MIN	TYP	MAX	
V_{IO} Input offset voltage	$V_{IC} = 0, V_O = 0, R_S = 50\ \Omega$	25°C	200	900		175	500	μV	
		Full range			1500		1000		
α_{VIO} Temperature coefficient of input offset voltage		Full range		1.7			1.7	$\mu\text{V}/^\circ\text{C}$	
I_{IO} Input offset current		25°C		7	100		7	100	nA
		Full range			200			200	
I_{IB} Input bias current		25°C		-0.7	-1.5		-0.7	-1.5	μA
	Full range			-1.7			-1.7		
V_{ICR} Common-mode input voltage range	$R_S = 50\ \Omega$	25°C	-15 to 13	-15.3 to 13.2		-15 to 13	-15.3 to 13.2	V	
		Full range	-15 to 12.7	-15.3 to 12.9		-15 to 12.7	-15.3 to 12.9		
V_{OM+} Maximum positive peak output voltage swing	$I_O = -150\ \mu\text{A}$	25°C	13.8	14.1		13.8	14.1	V	
	$I_O = -1.5\ \text{mA}$		13.7	14		13.7	14		
	$I_O = -15\ \text{mA}$	Full range	13.1	13.7		13.1	13.7		
	$I_O = -100\ \mu\text{A}$		13.7			13.7			
	$I_O = -1\ \text{mA}$		13.6			13.6			
	$I_O = -10\ \text{mA}$		13.1			13.1			
V_{OM-} Maximum negative peak output voltage swing	$I_O = 150\ \mu\text{A}$	25°C	-14.7	-14.9		-14.7	-14.9	V	
	$I_O = 1.5\ \text{mA}$		-14.5	-14.8		-14.5	-14.8		
	$I_O = 15\ \text{mA}$	Full range	-13.4	-13.8		-13.4	-13.8		
	$I_O = 100\ \mu\text{A}$		-14.6			-14.6			
	$I_O = 1\ \text{mA}$		-14.5			-14.5			
	$I_O = 10\ \text{mA}$		-13.4			-13.4			
A_{VD} Large-signal differential voltage amplification	$V_O = \pm 10\ \text{V}, R_L = 2\ \text{k}\Omega$	25°C	100	450		100	450	V/mV	
		Full range	40			40			
r_i Input resistance		25°C		65			65	$\text{M}\Omega$	
c_i Input capacitance		25°C		2.5			2.5	pF	
z_o Open-loop output impedance	$f = 1\ \text{MHz}$	25°C		30			30	Ω	
CMRR Common-mode rejection ratio	$V_{IC} = V_{ICRmin}, R_S = 50\ \Omega$	25°C	85	108		85	108	dB	
		Full range	80			80			
k_{SVR} Supply-voltage rejection ratio ($\Delta V_{CC\pm}/\Delta V_{IO}$)	$V_{CC\pm} = \pm 2.5\ \text{V to } \pm 15\ \text{V}, R_S = 50\ \Omega$	25°C	90	106		90	106	dB	
		Full range	85			85			
I_{OS} Short-circuit output current	$V_O = 0$	25°C	$V_{ID} = 1\ \text{V}$	-25	-50		-25	-50	mA
			$V_{ID} = -1\ \text{V}$	20	31		20	31	
I_{CC} Supply current	$V_O = 0, \text{ No load}$	25°C	3.5	4.5		3.5	4.5	mA	
		Full range		4.7			4.7		

† Full range is -40°C to 105°C .



TLE214x, TLE214xA
EXCALIBUR LOW-NOISE HIGH-SPEED
PRECISION OPERATIONAL AMPLIFIERS

SLOS183D – FEBRUARY 1997 – REVISED OCTOBER 2012

TLE2141I operating characteristics, $V_{CC\pm} = \pm 15\text{ V}$, $T_A = 25^\circ\text{C}$

PARAMETER		TEST CONDITIONS		TLE2141I			TLE2141AI			UNIT
				MIN	TYP	MAX	MIN	TYP	MAX	
SR+	Positive slew rate	$A_{VD} = -1$, $C_L = 500\text{ pF}$	$R_L = 2\text{ k}\Omega$	27	45		27	45	V/ μs	
SR-	Negative slew rate			27	42		27	42		
t_s	Settling time	$A_{VD} = -1$, 10-V step	To 0.1%	0.34			0.34			μs
			To 0.01%	0.4			0.4			
V_n	Equivalent input noise voltage	$R_S = 20\ \Omega$	$f = 10\text{ Hz}$	15			15			nV/ $\sqrt{\text{Hz}}$
			$f = 1\text{ kHz}$	10.5			10.5			
$V_{N(PP)}$	Peak-to-peak equivalent input noise voltage	$f = 0.1\text{ Hz to }1\text{ Hz}$		0.48			0.48			μV
		$f = 0.1\text{ Hz to }10\text{ Hz}$		0.51			0.51			
I_n	Equivalent input noise current	$f = 10\text{ Hz}$		1.89			1.89			pA/ $\sqrt{\text{Hz}}$
		$f = 1\text{ kHz}$		0.47			0.47			
THD + N	Total harmonic distortion plus noise	$V_{O(PP)} = 20\text{ V}$, $A_{VD} = 10$	$R_L = 2\text{ k}\Omega$, $f = 10\text{ kHz}$	0.01%			0.01%			
B_1	Unity-gain bandwidth	$R_L = 2\text{ k}\Omega$	$C_L = 100\text{ pF}$	6			6			MHz
	Gain-bandwidth product	$R_L = 2\text{ k}\Omega$, $f = 100\text{ kHz}$	$C_L = 100\text{ pF}$	5.9			5.9			MHz
B_{OM}	Maximum output-swing bandwidth	$V_{O(PP)} = 20\text{ V}$, $A_{VD} = 1$	$R_L = 2\text{ k}\Omega$, $C_L = 100\text{ pF}$	668			668			kHz
ϕ_m	Phase margin at unity gain	$R_L = 2\text{ k}\Omega$	$C_L = 100\text{ pF}$	58°			58°			

TLE214x, TLE214xA EXCALIBUR LOW-NOISE HIGH-SPEED PRECISION OPERATIONAL AMPLIFIERS

SLOS183D – FEBRUARY 1997 – REVISED OCTOBER 2012

TLE2142I electrical characteristics at specified free-air temperature, $V_{CC} = 5\text{ V}$ (unless otherwise noted)

PARAMETER	TEST CONDITIONS	T_A^\dagger	TLE2142I			TLE2142AI			UNIT
			MIN	TYP	MAX	MIN	TYP	MAX	
V_{IO} Input offset voltage	$V_O = 2.5\text{ V}$, $V_{IC} = 2.5\text{ V}$	25°C	220	1900		220	1500	μV	
		Full range			2400		2000		
α_{VIO} Temperature coefficient of input offset voltage		Full range	1.7			1.7		$\mu\text{V}/^\circ\text{C}$	
I_{IO} Input offset current		25°C	8	100		8	100	nA	
		Full range			200		200		
I_{IB} Input bias current		25°C	-0.8	-2		-0.8	-2	μA	
	Full range			-2.2		-2.2			
V_{ICR} Common-mode input voltage range	$R_S = 50\ \Omega$	25°C	0 to 3	-0.3 to 3.2		0 to 3	-0.3 to 3.2	V	
		Full range	0 to 2.7	-0.3 to 2.9		0 to 2.7	-0.3 to 2.9		
V_{OH} High-level output voltage	$I_{OH} = -150\ \mu\text{A}$	25°C	3.9	4.1		3.9	4.1	V	
	$I_{OH} = -1.5\text{ mA}$		3.8	4		3.8	4		
	$I_{OH} = -15\text{ mA}$		3.4	3.7		3.4	3.7		
	$I_{OH} = 100\ \mu\text{A}$	Full range	3.8			3.8			
	$I_{OH} = 1\text{ mA}$		3.7			3.7			
	$I_{OH} = 10\text{ mA}$		3.5			3.5			
V_{OL} Low-level output voltage	$I_{OL} = 150\ \mu\text{A}$	25°C	75	125		75	125	mV	
	$I_{OL} = 1.5\text{ mA}$		150	225		150	225		
	$I_{OL} = 15\text{ mA}$		1.2	1.4		1.2	1.4		
	$I_{OL} = 100\ \mu\text{A}$	Full range			175		175	mV	
	$I_{OL} = 1\text{ mA}$				225		225		
	$I_{OL} = 10\text{ mA}$				1.2		1.2		
A_{VD} Large-signal differential voltage amplification	$V_{IC} = \pm 2.5\text{ V}$, $V_O = 1\text{ V to } -1.5\text{ V}$, $R_L = 2\text{ k}\Omega$	25°C	50	220		50	220	V/mV	
		Full range	10			10			
r_i Input resistance		25°C	70			70	M Ω		
c_i Input capacitance		25°C	2.5			2.5	pF		
z_o Open-loop output impedance	$f = 1\text{ MHz}$	25°C	30			30	Ω		
CMRR Common-mode rejection ratio	$V_{IC} = V_{ICRmin}$, $R_S = 50\ \Omega$	25°C	85	118		85	118	dB	
		Full range	80			80			
k_{SVR} Supply-voltage rejection ratio ($\Delta V_{CC\pm} / \Delta V_{IO}$)	$V_{CC\pm} = \pm 2.5\text{ V to } \pm 15\text{ V}$, $R_S = 50\ \Omega$	25°C	90	106		90	106	dB	
		Full range	85			85			
I_{CC} Supply current	$V_O = 2.5\text{ V}$, $V_{IC} = 2.5\text{ V}$	No load,	25°C	6.6	8.8		6.6	8.8	mA
			Full range			9.2		9.2	

† Full range is -40°C to 105°C .



TLE214x, TLE214xA
EXCALIBUR LOW-NOISE HIGH-SPEED
PRECISION OPERATIONAL AMPLIFIERS

SLOS183D – FEBRUARY 1997 – REVISED OCTOBER 2012

TLE2142I operating characteristics, $V_{CC} = 5\text{ V}$, $T_A = 25^\circ\text{C}$

PARAMETER	TEST CONDITIONS	TLE2142I			TLE2142AI			UNIT
		MIN	TYP	MAX	MIN	TYP	MAX	
SR+	Positive slew rate	$A_{VD} = -1$, $R_L = 2\text{ k}\Omega^\dagger$, $C_L = 500\text{ pF}$			45			V/ μs
SR-	Negative slew rate				42			
t_s	Settling time	$A_{VD} = -1$, 2.5-V step	To 0.1%	0.16			μs	
			To 0.01%	0.22				
V_n	Equivalent input noise voltage	$R_S = 20\ \Omega$, $f = 10\text{ Hz}$	15			nV/ $\sqrt{\text{Hz}}$		
		$R_S = 20\ \Omega$, $f = 1\text{ kHz}$	10.5					
$V_{N(PP)}$	Peak-to-peak equivalent input noise voltage	$f = 0.1\text{ Hz to }1\text{ Hz}$	0.48			μV		
		$f = 0.1\text{ Hz to }10\text{ Hz}$	0.51					
I_n	Equivalent input noise current	$f = 10\text{ Hz}$	1.92			pA/ $\sqrt{\text{Hz}}$		
		$f = 1\text{ kHz}$	0.5					
THD + N	Total harmonic distortion plus noise	$V_O = 1\text{ V to }3\text{ V}$, $R_L = 2\text{ k}\Omega^\dagger$, $A_{VD} = 2$, $f = 10\text{ kHz}$	0.0052%					
B_1	Unity-gain bandwidth	$R_L = 2\text{ k}\Omega^\dagger$, $C_L = 100\text{ pF}$	5.9			MHz		
	Gain-bandwidth product	$R_L = 2\text{ k}\Omega^\dagger$, $C_L = 100\text{ pF}$, $f = 100\text{ kHz}$	5.8			MHz		
B_{OM}	Maximum output-swing bandwidth	$V_{O(PP)} = 2\text{ V}$, $R_L = 2\text{ k}\Omega^\dagger$, $A_{VD} = 1$, $C_L = 100\text{ pF}$	660			kHz		
ϕ_m	Phase margin at unity gain	$R_L = 2\text{ k}\Omega^\dagger$, $C_L = 100\text{ pF}$	57°					

$^\dagger R_L$ terminates at 2.5 V.

TLE214x, TLE214xA EXCALIBUR LOW-NOISE HIGH-SPEED PRECISION OPERATIONAL AMPLIFIERS

SLOS183D – FEBRUARY 1997 – REVISED OCTOBER 2012

TLE2142I electrical characteristics at specified free-air temperature, $V_{CC\pm} = \pm 15\text{ V}$ (unless otherwise noted)

PARAMETER	TEST CONDITIONS	T_A^\dagger	TLE2142I			TLE2142I			UNIT
			MIN	TYP	MAX	MIN	TYP	MAX	
V_{IO} Input offset voltage	$V_{IC} = 0, V_O = 0, R_S = 50\ \Omega,$	25°C	290	1200		275	750	μV	
		Full range			1800		1400		
α_{VIO} Temperature coefficient of input offset voltage		Full range	1.7			1.7		$\mu\text{V}/^\circ\text{C}$	
I_{IO} Input offset current		25°C	7	100		7	100	nA	
		Full range			200		200		
I_{IB} Input bias current		25°C	-0.7	-1.5		-0.7	-1.5	μA	
	Full range			-1.7		-1.7			
V_{ICR} Common-mode input voltage range	$R_S = 50\ \Omega$	25°C	-15 to 13	-15.3 to 13.2		-15 to 13	-15.3 to 13.2	V	
		Full range	-15 to 12.7	-15.3 to 12.9		-15 to 12.7	-15.3 to 12.9		
V_{OM+} Maximum positive peak output voltage swing	$I_O = -150\ \mu\text{A}, I_O = -1.5\ \text{mA}, I_O = -15\ \text{mA}, I_O = -100\ \mu\text{A}, I_O = -1\ \text{mA}, I_O = -10\ \text{mA}$	25°C	13.8	14.1		13.8	14.1	V	
			13.7	14		13.7	14		
			13.3	13.7		13.3	13.7		
		Full range	13.7			13.7			
			13.6			13.6			
			13.3			13.3			
V_{OM-} Maximum negative peak output voltage swing	$I_O = 150\ \mu\text{A}, I_O = 1.5\ \text{mA}, I_O = 15\ \text{mA}, I_O = 100\ \mu\text{A}, I_O = 1\ \text{mA}, I_O = 10\ \text{mA}$	25°C	-14.7	-14.9		-14.7	-14.9	V	
			-14.5	-14.8		-14.5	-14.8		
			-13.4	-13.8		-13.4	-13.8		
		Full range	-14.6			-14.6			
			-14.5			-14.5			
			-13.4			-13.4			
A_{VD} Large-signal differential voltage amplification	$V_O = \pm 10\ \text{V}, R_L = 2\ \text{k}\Omega$	25°C	100	450		100	450	V/mV	
		Full range	40			40			
r_i Input resistance		25°C	65			65	$\text{M}\Omega$		
c_i Input capacitance		25°C	2.5			2.5	pF		
z_o Open-loop output impedance	$f = 1\ \text{MHz}$	25°C	30			30	Ω		
CMRR Common-mode rejection ratio	$V_{IC} = V_{ICRmin}$	25°C	85	108		85	108	dB	
	$R_S = 50\ \Omega$	Full range	80			80			
k_{SVR} Supply-voltage rejection ratio ($\Delta V_{CC\pm} / \Delta V_{IO}$)	$V_{CC\pm} = \pm 2.5\ \text{V to } \pm 15\ \text{V}, R_S = 50\ \Omega$	25°C	90	106		90	106	dB	
		Full range	85			85			
I_{OS} Short-circuit output current	$V_O = 0$	25°C	$V_{ID} = 1\ \text{V}$	-25	-50		-25	-50	mA
			$V_{ID} = -1\ \text{V}$	20	31		20	31	
I_{CC} Supply current	$V_O = 0,$	No load	25°C	6.9	9		6.9	9	mA
			Full range			9.4		9.4	

† Full range is -40°C to 105°C .



TLE214x, TLE214xA
EXCALIBUR LOW-NOISE HIGH-SPEED
PRECISION OPERATIONAL AMPLIFIERS

SLOS183D – FEBRUARY 1997 – REVISED OCTOBER 2012

TLE2142I operating characteristics, $V_{CC\pm} = \pm 15\text{ V}$, $T_A = 25^\circ\text{C}$

PARAMETER	TEST CONDITIONS	TLE2142I			TLE2142AI			UNIT
		MIN	TYP	MAX	MIN	TYP	MAX	
SR+	Positive slew rate	$A_{VD} = -1$, $R_L = 2\text{ k}\Omega$, $C_L = 500\text{ pF}$		30	45	30	45	V/ μs
SR-	Negative slew rate			30	42	30	42	
t_s	Settling time	$A_{VD} = -1$, 10-V step	To 0.1%	0.34		0.34		μs
			To 0.01%	0.4		0.4		
V_n	Equivalent input noise voltage	$R_S = 20\ \Omega$, $f = 10\text{ Hz}$	15		15		nV/ $\sqrt{\text{Hz}}$	
		$R_S = 20\ \Omega$, $f = 1\text{ kHz}$	10.5		10.5			
$V_{N(PP)}$	Peak-to-peak equivalent input noise voltage	$f = 0.1\text{ Hz to }1\text{ Hz}$	0.48		0.48		μV	
		$f = 0.1\text{ Hz to }10\text{ Hz}$	0.51		0.51			
I_n	Equivalent input noise current	$f = 10\text{ Hz}$	1.89		1.89		pA/ $\sqrt{\text{Hz}}$	
		$f = 1\text{ kHz}$	0.47		0.47			
THD + N	Total harmonic distortion plus noise	$V_{O(PP)} = 20\text{ V}$, $A_{VD} = 10$,	$R_L = 2\text{ k}\Omega$, $f = 10\text{ kHz}$	0.01%		0.01%		
B_1	Unity-gain bandwidth	$R_L = 2\text{ k}\Omega$,	$C_L = 100\text{ pF}$	6		6		MHz
	Gain-bandwidth product	$R_L = 2\text{ k}\Omega$, $f = 100\text{ kHz}$	$C_L = 100\text{ pF}$,	5.9		5.9		MHz
B_{OM}	Maximum output-swing bandwidth	$V_{O(PP)} = 20\text{ V}$, $A_{VD} = 1$,	$R_L = 2\text{ k}\Omega$, $C_L = 100\text{ pF}$	668		668		kHz
ϕ_m	Phase margin at unity gain	$R_L = 2\text{ k}\Omega$,	$C_L = 100\text{ pF}$	58°		58°		

TLE214x, TLE214xA EXCALIBUR LOW-NOISE HIGH-SPEED PRECISION OPERATIONAL AMPLIFIERS

SLOS183D – FEBRUARY 1997 – REVISED OCTOBER 2012

TLE2144I electrical characteristics at specified free-air temperature, $V_{CC} = 5\text{ V}$ (unless otherwise noted)

PARAMETER	TEST CONDITIONS	T_A^\dagger	TLE2144I			TLE2144AI			UNIT
			MIN	TYP	MAX	MIN	TYP	MAX	
V_{IO} Input offset voltage	$V_{IC} = 0,$ $V_O = 0$ $R_S = 50\ \Omega$	25°C	0.5	3.8		0.5	3	mV	
		Full range			4.8		4		
α_{VIO} Temperature coefficient of input offset voltage		Full range	1.7			1.7		$\mu\text{V}/^\circ\text{C}$	
I_{IO} Input offset current		25°C	8	100		8	100	nA	
		Full range			200		200		
I_{IB} Input bias current		25°C	-0.8	-2		-0.8	-2	μA	
	Full range			-2.2		-2.2			
V_{ICR} Common-mode input voltage range	$R_S = 50\ \Omega$	25°C	0 to 3	-0.3 to 3.2		0 to 3	-0.3 to 3.2	V	
		Full range	0 to 2.7	-0.3 to 2.9		0 to 2.7	-0.3 to 2.9		
V_{OH} High-level output voltage	$I_{OH} = -150\ \mu\text{A}$ $I_{OH} = -1.5\ \text{mA}$ $I_{OH} = -15\ \text{mA}$ $I_{OH} = 100\ \mu\text{A}$ $I_{OH} = 1\ \text{mA}$ $I_{OH} = 10\ \text{mA}$	25°C	3.9	4.1		3.9	4.1	V	
			3.8	4		3.8	4		
			3.4	3.7		3.4	3.7		
		Full range	3.8			3.8			
			3.7			3.7			
			3.5			3.5			
V_{OL} Low-level output voltage	$I_{OL} = 150\ \mu\text{A}$ $I_{OL} = 1.5\ \mu\text{A}$ $I_{OL} = 15\ \text{mA}$ $I_{OL} = 100\ \mu\text{A}$ $I_{OL} = 1\ \text{mA}$ $I_{OL} = 10\ \text{mA}$	25°C	75	125		75	125	mV	
			150	225		150	225		
			1.2	1.6		1.2	1.6		
		Full range	175			175			
			225			225			
			1.4			1.4			
A_{VD} Large-signal differential voltage amplification	$V_{IC} = \pm 2.5\ \text{V},$ $V_O = 1\ \text{V to } -1.5\ \text{V}$ $R_L = 2\ \text{k}\Omega$	25°C	50	95		50	95	V/mV	
		Full range	10			10			
r_i Input resistance		25°C	70			70	$\text{M}\Omega$		
c_i Input capacitance		25°C	2.5			2.5	pF		
z_o Open-loop output impedance	$f = 1\ \text{MHz}$	25°C	30			30	Ω		
CMRR Common-mode rejection ratio	$V_{IC} = V_{ICRmin},$ $R_S = 50\ \Omega$	25°C	85	118		85	118	dB	
		Full range	80			80			
k_{SVR} Supply-voltage rejection ratio ($\Delta V_{CC\pm}/\Delta V_{IO}$)	$V_{CC\pm} = \pm 2.5\ \text{V to } \pm 15\ \text{V},$ $R_S = 50\ \Omega$	25°C	90	106		90	106	dB	
		Full range	85			85			
I_{CC} Supply current	$V_O = 2.5\ \text{V},$ $V_{IC} = 2.5\ \text{V}$ No load,	25°C	13.2	17.6		13.2	17.6	mA	
		Full range			18.4		18.4		

† Full range is -40°C to 105°C .



TLE214x, TLE214xA
EXCALIBUR LOW-NOISE HIGH-SPEED
PRECISION OPERATIONAL AMPLIFIERS

SLOS183D – FEBRUARY 1997 – REVISED OCTOBER 2012

TLE2144I operating characteristics, $V_{CC} = 5\text{ V}$, $T_A = 25^\circ\text{C}$

PARAMETER	TEST CONDITIONS	TLE2144I			TLE2144AI			UNIT	
		MIN	TYP	MAX	MIN	TYP	MAX		
SR+	Positive slew rate	$A_{VD} = -1$, $C_L = 500\text{ pF}$		$R_L = 2\text{ k}\Omega^\dagger$		45		V/ μs	
SR-	Negative slew rate					42			
t_s	Settling time	$A_{VD} = -1$, 2.5-V step	To 0.1%	0.16		0.16		μs	
			To 0.01%	0.22		0.22			
V_n	Equivalent input noise voltage	$R_S = 20\ \Omega$, $f = 10\text{ Hz}$	15		15		nV/ $\sqrt{\text{Hz}}$		
		$R_S = 20\ \Omega$, $f = 1\text{ kHz}$	10.5		10.5				
$V_{N(PP)}$	Peak-to-peak equivalent input noise voltage	$f = 0.1\text{ Hz to }1\text{ Hz}$		0.48		0.48		μV	
		$f = 0.1\text{ Hz to }10\text{ Hz}$		0.51		0.51			
I_n	Equivalent input noise current	$f = 10\text{ Hz}$		1.92		1.92		pA/ $\sqrt{\text{Hz}}$	
		$f = 10\text{ kHz}$		0.5		0.5			
THD + N	Total harmonic distortion plus noise	$V_O = 1\text{ V to }3\text{ V}$, $A_{VD} = 2$,	$R_L = 2\text{ k}\Omega^\dagger$, $f = 10\text{ kHz}$		0.0052%		0.0052%		
B_1	Unity-gain bandwidth	$R_L = 2\text{ k}\Omega^\dagger$,	$C_L = 100\text{ pF}$		5.9		5.9		MHz
	Gain-bandwidth product	$R_L = 2\text{ k}\Omega^\dagger$, $f = 100\text{ kHz}$	$C_L = 100\text{ pF}$		5.8		5.8		MHz
B_{OM}	Maximum output-swing bandwidth	$V_{O(PP)} = 2\text{ V}$, $A_{VD} = 1$,	$R_L = 2\text{ k}\Omega^\dagger$, $C_L = 100\text{ pF}$		660		660		kHz
ϕ_m	Phase margin at unity gain	$R_L = 2\text{ k}\Omega^\dagger$,	$C_L = 100\text{ pF}$		57°		57°		

[†] R_L terminates at 2.5 V

TLE214x, TLE214xA EXCALIBUR LOW-NOISE HIGH-SPEED PRECISION OPERATIONAL AMPLIFIERS

SLOS183D – FEBRUARY 1997 – REVISED OCTOBER 2012

TLE2144I electrical characteristics at specified free-air temperature, $V_{CC\pm} = \pm 15\text{ V}$ (unless otherwise noted)

PARAMETER	TEST CONDITIONS	T_A^\dagger	TLE2144I			TLE2144AI			UNIT	
			MIN	TYP	MAX	MIN	TYP	MAX		
V_{IO} Input offset voltage	$V_{IC} = 0,$ $V_O = 0$	25°C	0.6	2.4		0.5	1.5	mV		
			Full range			3.2			2.8	
α_{VIO} Temperature coefficient of input offset voltage		25°C	Full range			1.7			$\mu\text{V}/^\circ\text{C}$	
I_{IO} Input offset current			25°C	7	100		7	100	nA	
		Full range			200			200		
I_{IB} Input bias current		25°C	Full range			-0.7 -1.5			μA	
	Full range			-1.7			-1.7			
V_{ICR} Common-mode input voltage range	$R_S = 50\ \Omega$	25°C	-15 to 13	-15.3 to 13.2		-15 to 13	-15.3 to 13.2	V		
		Full range			-15 to 12.7				-15.3 to 12.9	
V_{OM+} Maximum positive peak output voltage swing	$I_O = -150\ \mu\text{A}$ $I_O = -1.5\ \text{mA}$ $I_O = -15\ \text{mA}$ $I_O = -100\ \mu\text{A}$ $I_O = -1\ \text{mA}$ $I_O = -10\ \text{mA}$	25°C	13.8	14.1		13.8	14.1	V		
			Full range			13.7			14	
			Full range			13.1			13.7	
		Full range			13.7				13.7	
		Full range			13.6				13.6	
		Full range			13.1				13.1	
V_{OM-} Maximum negative peak output voltage swing	$I_O = 150\ \mu\text{A}$ $I_O = 1.5\ \text{mA}$ $I_O = 15\ \text{mA}$ $I_O = 100\ \mu\text{A}$ $I_O = 1\ \text{mA}$ $I_O = 10\ \text{mA}$	25°C	-14.7	-14.9		-14.7	-14.9	V		
			Full range			-14.5			-14.8	
			Full range			-13.4			-13.8	
		Full range			-14.6				-14.6	
		Full range			-14.5				-14.5	
		Full range			-13.4				-13.4	
A_{VD} Large-signal differential voltage amplification	$V_O = \pm 10\ \text{V},$ $R_L = 2\ \text{k}\Omega$	25°C	100	170		100	170	V/mV		
		Full range			40				40	
r_i Input resistance		25°C	65			65			M Ω	
c_i Input capacitance		25°C	2.5			2.5			pF	
z_o Open-loop output impedance	$f = 1\ \text{MHz}$	25°C	30			30			Ω	
CMRR Common-mode rejection ratio	$V_{IC} = V_{ICRmin},$ $R_S = 50\ \Omega$	25°C	85	108		85	108	dB		
		Full range			80				80	
k_{SVR} Supply-voltage rejection ratio ($\Delta V_{CC\pm}/\Delta V_{IO}$)	$V_{CC\pm} = \pm 2.5\ \text{V to } \pm 15\ \text{V},$ $R_S = 50\ \Omega$	25°C	90	106		90	106	dB		
		Full range			85				85	
I_{OS} Short-circuit output current	$V_O = 0$	25°C	$V_{ID} = 1\ \text{V}$	-25	-50		-25	-50	mA	
			$V_{ID} = -1\ \text{V}$	20	31		20	31		
I_{CC} Supply current	$V_O = 0,$ No load	25°C	13.8	18		13.8	18	mA		
		Full range			18.8				18.8	

† Full range is -40°C to 105°C .



TLE214x, TLE214xA
EXCALIBUR LOW-NOISE HIGH-SPEED
PRECISION OPERATIONAL AMPLIFIERS

SLOS183D – FEBRUARY 1997 – REVISED OCTOBER 2012

TLE2144I operating characteristics, $V_{CC\pm} = \pm 15\text{ V}$, $T_A = 25^\circ\text{C}$

PARAMETER	TEST CONDITIONS	TLE2144I			TLE2144AI			UNIT
		MIN	TYP	MAX	MIN	TYP	MAX	
SR+	Positive slew rate	$A_{VD} = -1$, $R_L = 2\text{ k}\Omega$, $C_L = 500\text{ pF}$		27	45	27	45	V/ μs
SR-	Negative slew rate			27	42	27	42	
t_s	Settling time	$A_{VD} = -1$, 10-V step	To 0.1%	0.34		0.34		μs
			To 0.01%	0.4		0.4		
V_n	Equivalent input noise voltage	$R_S = 20\ \Omega$, $f = 10\text{ Hz}$	15		15		nV/ $\sqrt{\text{Hz}}$	
		$R_S = 20\ \Omega$, $f = 1\text{ kHz}$	10.5		10.5			
$V_{N(PP)}$	Peak-to-peak equivalent input noise voltage	$f = 0.1\text{ Hz to }1\text{ Hz}$	0.48		0.48		μV	
		$f = 0.1\text{ Hz to }10\text{ Hz}$	0.51		0.51			
I_n	Equivalent input noise current	$f = 10\text{ Hz}$	1.89		1.89		pA/ $\sqrt{\text{Hz}}$	
		$f = 1\text{ kHz}$	0.47		0.47			
THD + N	Total harmonic distortion plus noise	$V_{O(PP)} = 20\text{ V}$, $A_{VD} = 10$,	$R_L = 2\text{ k}\Omega$, $f = 10\text{ kHz}$	0.01%		0.01%		
B_1	Unity-gain bandwidth	$R_L = 2\text{ k}\Omega$,	$C_L = 100\text{ pF}$	6		6		MHz
	Gain-bandwidth product	$R_L = 2\text{ k}\Omega$, $f = 100\text{ kHz}$	$C_L = 100\text{ pF}$,	5.9		5.9		MHz
B_{OM}	Maximum output-swing bandwidth	$V_{O(PP)} = 20\text{ V}$, $A_{VD} = 1$,	$R_L = 2\text{ k}\Omega$, $C_L = 100\text{ pF}$	668		668		kHz
ϕ_m	Phase margin at unity gain	$R_L = 2\text{ k}\Omega$,	$C_L = 100\text{ pF}$	58°		58°		

TLE214x, TLE214xA EXCALIBUR LOW-NOISE HIGH-SPEED PRECISION OPERATIONAL AMPLIFIERS

SLOS183D – FEBRUARY 1997 – REVISED OCTOBER 2012

TLE2141M electrical characteristics at specified free-air temperature, $V_{CC} = 5\text{ V}$ (unless otherwise noted)

PARAMETER	TEST CONDITIONS	T_A^\dagger	TLE2141M			TLE2141AM			UNIT
			MIN	TYP	MAX	MIN	TYP	MAX	
V_{IO} Input offset voltage	$V_O = 2.5\text{ V}$ $V_{IC} = 2.5\text{ V}$ $R_S = 50\ \Omega$	25°C	225	1400		200	1000	μV	
		Full range			2100		1700		
α_{VIO} Temperature coefficient of input offset voltage		Full range	1.7			1.7		$\mu\text{V}/^\circ\text{C}$	
I_{IO} Input offset current		25°C	8	100		8	100	nA	
		Full range			250		250		
I_{IB} Input bias current		25°C	-0.8	-2		-0.8	-2	μA	
	Full range			-2.3		-2.3			
V_{ICR} Common-mode input voltage range	$R_S = 50\ \Omega$	25°C	0 to 3	-0.3 to 3.2		0 to 3	-0.3 to 3.2	V	
		Full range	0 to 2.7	-0.3 to 2.9		0 to 2.7	-0.3 to 2.9		
V_{OH} High-level output voltage	$I_{OH} = -150\ \mu\text{A}$	25°C	3.9	4.1		3.9	4.1	V	
	$I_{OH} = -1.5\text{ mA}$		3.8	4		3.8	4		
	$I_{OH} = -15\text{ mA}$	Full range	3.2	3.7		3.2	3.7		
	$I_{OH} = -100\ \mu\text{A}$		3.75			3.75			
	$I_{OH} = -1\text{ mA}$		3.65			3.65			
	$I_{OH} = -10\text{ mA}$		3.25			3.25			
V_{OL} Low-level output voltage	$I_{OL} = 150\ \mu\text{A}$	25°C	75	125		75	125	mV	
	$I_{OL} = 1.5\ \mu\text{A}$		150	225		150	225		
	$I_{OL} = 15\text{ mA}$	Full range	1.2	1.4		1.2	1.4	V	
	$I_{OL} = 100\ \mu\text{A}$		200			200			
	$I_{OL} = 1\text{ mA}$		250			225			
	$I_{OL} = 10\text{ mA}$		1.25			1.25			
A_{VD} Large-signal differential voltage amplification	$V_{IC} = \pm 2.5\text{ V}$, $V_O = 1\text{ V to } -1.5\text{ V}$ $R_L = 2\text{ k}\Omega$	25°C	50	220		50	220	V/mV	
		Full range	5			5			
r_i Input resistance		25°C	70			70	$\text{M}\Omega$		
c_i Input capacitance		25°C	2.5			2.5	pF		
z_o Open-loop output impedance	$f = 1\text{ MHz}$	25°C	30			30	Ω		
CMRR Common-mode rejection ratio	$V_{IC} = V_{ICRmin}$, $R_S = 50\ \Omega$	25°C	85	118		85	118	dB	
		Full range	80			80			
k_{SVR} Supply-voltage rejection ratio ($\Delta V_{CC\pm}/\Delta V_{IO}$)	$V_{CC\pm} = \pm 2.5\text{ V to } \pm 15\text{ V}$, $R_S = 50\ \Omega$	25°C	90	106		90	106	dB	
		Full range	85			85			
I_{CC} Supply current	$V_O = 2.5\text{ V}$, $V_{IC} = 2.5\text{ V}$ No load,	25°C	3.4	4.4		3.4	4.4	mA	
		Full range			4.6		4.6		

† Full range is -55°C to 125°C .



TLE214x, TLE214xA
EXCALIBUR LOW-NOISE HIGH-SPEED
PRECISION OPERATIONAL AMPLIFIERS

SLOS183D – FEBRUARY 1997 – REVISED OCTOBER 2012

TLE2141M operating characteristics, $V_{CC} = 5\text{ V}$, $T_A = 25^\circ\text{C}$

PARAMETER		TEST CONDITIONS		TLE2141M			TLE2141AM			UNIT	
				MIN	TYP	MAX	MIN	TYP	MAX		
SR+	Positive slew rate	$A_{VD} = -1$, $C_L = 500\text{ pF}$		$R_L = 2\text{ k}\Omega^\dagger$		45			V/ μs		
SR-	Negative slew rate					42					
t_s	Settling time	$A_{VD} = -1$, 2.5-V step		To 0.1%		0.16			μs		
				To 0.01%		0.22					
V_n	Equivalent input noise voltage	$R_S = 20\ \Omega$, $f = 10\text{ Hz}$		15			15			nV/ $\sqrt{\text{Hz}}$	
		$R_S = 20\ \Omega$, $f = 1\text{ kHz}$		10.5			10.5				
$V_{N(PP)}$	Peak-to-peak equivalent input noise voltage	$f = 0.1\text{ Hz to }1\text{ Hz}$		0.48			0.48			μV	
		$f = 0.1\text{ Hz to }10\text{ Hz}$		0.51			0.51				
I_n	Equivalent input noise current	$f = 10\text{ Hz}$		1.92			1.92			pA/ $\sqrt{\text{Hz}}$	
		$f = 1\text{ kHz}$		0.5			0.5				
THD + N	Total harmonic distortion plus noise	$V_O = 1\text{ V to }3\text{ V}$, $A_{VD} = 2$		$R_L = 2\text{ k}\Omega^\dagger$, $f = 10\text{ kHz}$		0.0052%			0.0052%		
B_1	Unity-gain bandwidth	$R_L = 2\text{ k}\Omega^\dagger$, $C_L = 100\text{ pF}^\dagger$		5.9			5.9			MHz	
	Gain-bandwidth product	$R_L = 2\text{ k}\Omega^\dagger$, $f = 100\text{ kHz}$		5.8			5.8			MHz	
B_{OM}	Maximum output-swing bandwidth	$V_{O(PP)} = 2\text{ V}$, $A_{VD} = 1$		$R_L = 2\text{ k}\Omega^\dagger$		660			660		kHz
ϕ_m	Phase margin at unity gain	$R_L = 2\text{ k}\Omega^\dagger$, $C_L = 100\text{ pF}^\dagger$		57°			57°				

$^\dagger R_L$ and C_L terminated to 2.5 V.

TLE214x, TLE214xA EXCALIBUR LOW-NOISE HIGH-SPEED PRECISION OPERATIONAL AMPLIFIERS

SLOS183D – FEBRUARY 1997 – REVISED OCTOBER 2012

TLE2141M electrical characteristics at specified free-air temperature, $V_{CC\pm} = \pm 15\text{ V}$ (unless otherwise noted)

PARAMETER	TEST CONDITIONS	T_A^\dagger	TLE2141M			TLE2141AM			UNIT
			MIN	TYP	MAX	MIN	TYP	MAX	
V_{IO} Input offset voltage	$V_{IC} = 0, R_S = 50\ \Omega$	25°C	200	900		175	500	μV	
		Full range			1700		1200		
α_{VIO} Temperature coefficient of input offset voltage		Full range	1.7			1.7		$\mu\text{V}/^\circ\text{C}$	
I_{IO} Input offset current		25°C	7	100		7	100	nA	
		Full range			250		250		
I_{IB} Input bias current		25°C	-0.7	-1.5		-0.7	-1.5	μA	
	Full range			-1.8		-1.8			
V_{ICR} Common-mode input voltage range	$R_S = 50\ \Omega$	25°C	-15 to 13	-15.3 to 13.2		-15 to 13	-15.3 to 13.2	V	
		Full range	-15 to 12.7	-15.3 to 12.9		-15 to 12.7	-15.3 to 12.9		
V_{OM+} Maximum positive peak output voltage swing	$I_O = -150\ \mu\text{A}$	25°C	13.8	14.1		13.8	14.1	V	
	$I_O = -1.5\ \text{mA}$		13.7	14		13.7	14		
	$I_O = -15\ \text{mA}$	Full range	13.1	13.7		13.1	13.7		
	$I_O = -100\ \mu\text{A}$		13.7			13.7			
	$I_O = -1\ \text{mA}$		13.6			13.6			
	$I_O = -10\ \text{mA}$		13.1			13.1			
V_{OM-} Maximum negative peak output voltage swing	$I_O = 150\ \mu\text{A}$	25°C	-14.7	-14.9		-14.7	-14.9	V	
	$I_O = 1.5\ \text{mA}$		-14.5	-14.8		-14.5	-14.8		
	$I_O = 15\ \text{mA}$	Full range	-13.4	-13.8		-13.4	-13.8		
	$I_O = 100\ \mu\text{A}$		-14.6			-14.6			
	$I_O = 1\ \text{mA}$		-14.5			-14.5			
	$I_O = 10\ \text{mA}$		-13.4			-13.4			
A_{VD} Large-signal differential voltage amplification	$V_O = \pm 10\ \text{V}, R_L = 2\ \text{k}\Omega$	25°C	100	450		100	450	V/mV	
		Full range	20			20			
r_i Input resistance		25°C	65			65	$\text{M}\Omega$		
c_i Input capacitance		25°C	2.5			2.5	pF		
z_o Open-loop output impedance	$f = 1\ \text{MHz}$	25°C	30			30	Ω		
CMRR Common-mode rejection ratio	$V_{IC} = V_{ICRmin}, R_S = 50\ \Omega$	25°C	85	108		85	108	dB	
		Full range	80			80			
k_{SVR} Supply-voltage rejection ratio ($\Delta V_{CC\pm}/\Delta V_{IO}$)	$V_{CC\pm} = \pm 2.5\ \text{V to } \pm 15\ \text{V}, R_S = 50\ \Omega$	25°C	90	106		90	106	dB	
		Full range	85			85			
I_{OS} Short-circuit output current	$V_O = 0$	25°C	$V_{ID} = 1\ \text{V}$	-25	-50		-25	-50	mA
			$V_{ID} = -1\ \text{V}$	20	31		20	31	
I_{CC} Supply current	$V_O = 0, V_{IC} = 2.5\ \text{V}$	No load,	25°C	3.5	4.5		3.5	4.5	mA
			Full range			4.7		4.7	

† Full range is -55°C to 125°C .



TLE214x, TLE214xA
EXCALIBUR LOW-NOISE HIGH-SPEED
PRECISION OPERATIONAL AMPLIFIERS

SLOS183D – FEBRUARY 1997 – REVISED OCTOBER 2012

TLE2141M operating characteristics, $V_{CC\pm} = \pm 15\text{ V}$, $T_A = 25^\circ\text{C}$

PARAMETER		TEST CONDITIONS		TLE2141M			TLE2141AM			UNIT
				MIN	TYP	MAX	MIN	TYP	MAX	
SR+	Positive slew rate	$A_{VD} = -1$, $C_L = 100\text{ pF}$	$R_L = 2\text{ k}\Omega$	27	45		27	45	V/ μs	
SR-	Negative slew rate			27	42		27	42		
t_s	Settling time	$A_{VD} = -1$, 10-V step	To 0.1%	0.34			0.34			μs
			To 0.01%	0.4			0.4			
V_n	Equivalent input noise voltage	$R_S = 20\ \Omega$	$f = 10\text{ Hz}$	15			15			nV/ $\sqrt{\text{Hz}}$
			$f = 1\text{ kHz}$	10.5			10.5			
$V_{N(PP)}$	Peak-to-peak equivalent input noise voltage	$f = 0.1\text{ Hz to }1\text{ Hz}$		0.48			0.48			μV
		$f = 0.1\text{ Hz to }10\text{ Hz}$		0.51			0.51			
I_n	Equivalent input noise current	$f = 10\text{ Hz}$		1.89			1.89			pA/ $\sqrt{\text{Hz}}$
		$f = 1\text{ kHz}$		0.47			0.47			
THD + N	Total harmonic distortion plus noise	$V_{O(PP)} = 20\text{ V}$, $A_{VD} = 10$,	$R_L = 2\text{ k}\Omega$, $f = 10\text{ kHz}$	0.01%			0.01%			
B_1	Unity-gain bandwidth	$R_L = 2\text{ k}\Omega$,	$C_L = 100\text{ pF}$	6			6			MHz
	Gain-bandwidth product	$R_L = 2\text{ k}\Omega$, $f = 100\text{ kHz}$	$C_L = 100\text{ pF}$,	5.9			5.9			MHz
B_{OM}	Maximum output-swing bandwidth	$V_{O(PP)} = 20\text{ V}$, $A_{VD} = 1$,	$R_L = 2\text{ k}\Omega$, $C_L = 100\text{ pF}$	668			668			kHz
ϕ_m	Phase margin at unity gain	$R_L = 2\text{ k}\Omega$,	$C_L = 100\text{ pF}$	58°			58°			

TLE214x, TLE214xA EXCALIBUR LOW-NOISE HIGH-SPEED PRECISION OPERATIONAL AMPLIFIERS

SLOS183D – FEBRUARY 1997 – REVISED OCTOBER 2012

TLE2142M electrical characteristics at specified free-air temperature, $V_{CC} = 5\text{ V}$ (unless otherwise noted)

PARAMETER	TEST CONDITIONS	T_A^\dagger	TLE2142M			TLE2142AM			UNIT	
			MIN	TYP	MAX	MIN	TYP	MAX		
V_{IO} Input offset voltage	$V_O = 2.5\text{ V},$ $V_{IC} = 2.5\text{ V}$	25°C	220	1900		200	1500	μV		
			Full range		2600		2200			
α_{VIO} Temperature coefficient of input offset voltage		Full range	25°C	1.7			1.7			$\mu\text{V}/^\circ\text{C}$
				8			100			
I_{IO} Input offset current		Full range	25°C	200			200			nA
				-0.8			-2			
I_{IB} Input bias current	Full range	25°C	-2.3			-2.3			μA	
			0			-0.3				
V_{ICR} Common-mode input voltage range	$R_S = 50\ \Omega$	25°C	to	to		to	to	V		
			3	3.2		3	3.2			
		Full range	0	-0.3		0	-0.3	V		
			2.7	2.9		2.7	2.9			
V_{OH} High-level output voltage	$I_{OH} = -150\ \mu\text{A}$ $I_{OH} = -1.5\text{ mA}$ $I_{OH} = -15\text{ mA}$ $I_{OH} = 100\ \mu\text{A}$ $I_{OH} = 1\text{ mA}$ $I_{OH} = 10\text{ mA}$	25°C	3.9	4.1		3.9	4.1	V		
			3.8	4		3.8	4			
			3.4	3.7		3.4	3.7			
		Full range	3.75		3.75		3.75			
			3.65		3.65		3.65			
			3.45		3.45		3.45			
V_{OL} Low-level output voltage	$I_{OL} = 150\ \mu\text{A}$ $I_{OL} = 1.5\text{ mA}$ $I_{OL} = 15\text{ mA}$ $I_{OL} = 100\ \mu\text{A}$ $I_{OL} = 1\text{ mA}$ $I_{OL} = 10\text{ mA}$	25°C	75	125		75	125	mV		
			150	225		150	225			
			1.2	1.4		1.2	1.4			
		Full range	200		200		200			
			250		250		250			
			1.25		1.25		1.25			
A_{VD} Large-signal differential voltage amplification	$V_{IC} = \pm 2.5\text{ V},$ $R_L = 2\text{ k}\Omega,$ $V_O = 1\text{ V to } -1.5\text{ V}$	25°C	50	220		50	220	V/mV		
		Full range	5		5					
r_i Input resistance		25°C	70			70			M Ω	
c_i Input capacitance		25°C	2.5			2.5			pF	
z_o Open-loop output impedance	$f = 1\text{ MHz}$	25°C	30			30			Ω	
CMRR Common-mode rejection ratio	$V_{IC} = V_{ICRmin},$ $R_S = 50\ \Omega$	25°C	85	118		85	118	dB		
		Full range	80			80				
k_{SVR} Supply-voltage rejection ratio ($\Delta V_{CC\pm} / \Delta V_{IO}$)	$V_{CC\pm} = \pm 2.5\text{ V to } \pm 15\text{ V},$ $R_S = 50\ \Omega$	25°C	90	106		90	106	dB		
		Full range	85			85				
I_{CC} Supply current	$V_O = 2.5\text{ V},$ $V_{IC} = 2.5\text{ V}$	No load,	25°C	6.6	8.8		6.6	8.8	mA	
			Full range	9.2			9.2			

† Full range is -55°C to 125°C .



TLE214x, TLE214xA
EXCALIBUR LOW-NOISE HIGH-SPEED
PRECISION OPERATIONAL AMPLIFIERS

SLOS183D – FEBRUARY 1997 – REVISED OCTOBER 2012

TLE2142M operating characteristics, $V_{CC} = 5\text{ V}$, $T_A = 25^\circ\text{C}$

PARAMETER	TEST CONDITIONS	TLE2142M			TLE2142AM			UNIT
		MIN	TYP	MAX	MIN	TYP	MAX	
SR+	Positive slew rate	$A_{VD} = -1$, $C_L = 500\text{ pF}$		$R_L = 2\text{ k}\Omega^\dagger$	45			$\text{V}/\mu\text{s}$
SR-	Negative slew rate				42			
t_s	Settling time	$A_{VD} = -1$, 2.5-V step	To 0.1%	0.16			μs	
			To 0.01%	0.22				
V_n	Equivalent input noise voltage	$R_S = 20\ \Omega$	$f = 10\text{ Hz}$	15			$\text{nV}/\sqrt{\text{Hz}}$	
			$f = 1\text{ kHz}$	10.5				
$V_{N(PP)}$	Peak-to-peak equivalent input noise voltage	$f = 0.1\text{ Hz to }1\text{ Hz}$		0.48			μV	
		$f = 0.1\text{ Hz to }10\text{ Hz}$		0.51				
I_n	Equivalent input noise current	$f = 10\text{ Hz}$		1.92			$\text{pA}/\sqrt{\text{Hz}}$	
		$f = 1\text{ kHz}$		0.5				
THD + N	Total harmonic distortion plus noise	$V_O = 1\text{ V to }3\text{ V}$, $A_{VD} = 2$,	$R_L = 2\text{ k}\Omega^\dagger$, $f = 10\text{ kHz}$	0.0052%				
B_1	Unity-gain bandwidth	$R_L = 2\text{ k}\Omega^\dagger$,	$C_L = 100\text{ pF}$	5.9			MHz	
	Gain-bandwidth product	$R_L = 2\text{ k}\Omega^\dagger$, $f = 100\text{ kHz}$	$C_L = 100\text{ pF}$	5.8			MHz	
B_{OM}	Maximum output-swing bandwidth	$V_{O(PP)} = 2\text{ V}$, $A_{VD} = 1$,	$R_L = 2\text{ k}\Omega^\dagger$, $C_L = 100\text{ pF}$	660			kHz	
ϕ_m	Phase margin	$R_L = 2\text{ k}\Omega^\dagger$,	$C_L = 100\text{ pF}$	57°				

$^\dagger R_L$ terminates at 2.5 V.

TLE214x, TLE214xA EXCALIBUR LOW-NOISE HIGH-SPEED PRECISION OPERATIONAL AMPLIFIERS

SLOS183D – FEBRUARY 1997 – REVISED OCTOBER 2012

TLE2142M electrical characteristics at specified free-air temperature, $V_{CC\pm} = \pm 15\text{ V}$ (unless otherwise noted)

PARAMETER	TEST CONDITIONS	T_A^\dagger	TLE2142M			TLE2142AM			UNIT
			MIN	TYP	MAX	MIN	TYP	MAX	
V_{IO} Input offset voltage	$V_{IC} = 0, R_S = 50\ \Omega$	25°C	290	1200		275	750	μV	
		Full range			2000		1600		
α_{VIO} Temperature coefficient of input offset voltage		Full range		1.7			1.7	$\mu\text{V}/^\circ\text{C}$	
I_{IO} Input offset current		25°C	7	100		7	100	nA	
		Full range			250		250		
I_{IB} Input bias current		25°C	-0.7	-1.5		-0.7	-1.5	μA	
	Full range			-1.8		-1.8			
V_{ICR} Common-mode input voltage range	$R_S = 50\ \Omega$	25°C	-15 to 13	-15.3 to 13.2		-15 to 13	-15.3 to 13.2	V	
		Full range	-15 to 12.7	-15.3 to 12.9		-15 to 12.7	-15.3 to 12.9		
V_{OM+} Maximum positive peak output voltage swing	$I_O = -150\ \mu\text{A}$ $I_O = -1.5\ \text{mA}$ $I_O = -15\ \text{mA}$ $I_O = -100\ \mu\text{A}$ $I_O = -1\ \text{mA}$ $I_O = -10\ \text{mA}$	25°C	13.8	14.1		13.8	14.1	V	
			13.7	14		13.7	14		
			13.3	13.7		13.3	13.7		
		Full range	13.7			13.7			
			13.6			13.6			
			13.3			13.3			
V_{OM-} Maximum negative peak output voltage swing	$I_O = 150\ \mu\text{A}$ $I_O = 1.5\ \text{mA}$ $I_O = 15\ \text{mA}$ $I_O = 100\ \mu\text{A}$ $I_O = 1\ \text{mA}$ $I_O = 10\ \text{mA}$	25°C	-14.7	-14.9		-14.7	-14.9	V	
			-14.5	-14.8		-14.5	-14.8		
			-13.4	-13.8		-13.4	-13.8		
		Full range	-14.6			-14.6			
			-14.5			-14.5			
			-13.4			-13.4			
A_{VD} Large-signal differential voltage amplification	$V_O = \pm 10\ \text{V}, R_L = 2\ \text{k}\Omega$	25°C	100	450		100	450	V/mV	
		Full range	20			20			
r_i Input resistance		25°C	65			65	$\text{M}\Omega$		
c_i Input capacitance		25°C	2.5			2.5	pF		
z_o Open-loop output impedance	$f = 1\ \text{MHz}$	25°C	30			30	Ω		
CMRR Common-mode rejection ratio	$V_{IC} = V_{ICRmin}, R_S = 50\ \Omega$	25°C	85	108		85	108	dB	
		Full range	80			80			
k_{SVR} Supply-voltage rejection ratio ($\Delta V_{CC\pm} / \Delta V_{IO}$)	$V_{CC\pm} = \pm 2.5\ \text{V to } \pm 15\ \text{V}, R_S = 50\ \Omega$	25°C	90	106		90	106	dB	
		Full range	85			85			
I_{OS} Short-circuit output current	$V_O = 0$	25°C	$V_{ID} = 1\ \text{V}$	-25	-50		-25	-50	mA
			$V_{ID} = -1\ \text{V}$	20	31		20	31	
I_{CC} Supply current	$V_O = 0, V_{IC} = 2.5\ \text{V}$	No load,	25°C	6.9	9		6.9	9	mA
			Full range			9.4		9.4	

† Full range is -55°C to 125°C .



TLE214x, TLE214xA
EXCALIBUR LOW-NOISE HIGH-SPEED
PRECISION OPERATIONAL AMPLIFIERS

SLOS183D – FEBRUARY 1997 – REVISED OCTOBER 2012

TLE2142M operating characteristics, $V_{CC\pm} = \pm 15\text{ V}$, $T_A = 25^\circ\text{C}$

PARAMETER	TEST CONDITIONS	TLE2142M			TLE2142AM			UNIT
		MIN	TYP	MAX	MIN	TYP	MAX	
SR+	Positive slew rate	$R_L = 2\text{ k}\Omega$, $A_{VD} = -1$, $C_L = 100\text{ pF}$		27	45	27	45	V/ μs
SR-	Negative slew rate			27	42	27	42	
t_s	Settling time	$A_{VD} = -1$, 10-V step	To 0.1%	0.34		0.34		μs
			To 0.01%	0.4		0.4		
V_n	Equivalent input noise voltage	$R_S = 20\ \Omega$, $f = 10\text{ Hz}$	15		15		nV/ $\sqrt{\text{Hz}}$	
		$R_S = 20\ \Omega$, $f = 1\text{ kHz}$	10.5		10.5			
$V_{N(PP)}$	Peak-to-peak equivalent input noise voltage	$f = 0.1\text{ Hz to }1\text{ Hz}$	0.48		0.48		μV	
		$f = 0.1\text{ Hz to }10\text{ Hz}$	0.51		0.51			
I_n	Equivalent input noise current	$f = 10\text{ Hz}$	1.89		1.89		pA/ $\sqrt{\text{Hz}}$	
		$f = 1\text{ kHz}$	0.47		0.47			
THD + N	Total harmonic distortion plus noise	$V_{O(PP)} = 20\text{ V}$, $R_L = 2\text{ k}\Omega$, $A_{VD} = 10$, $f = 10\text{ kHz}$	0.01%		0.01%			
B_1	Unity-gain bandwidth	$R_L = 2\text{ k}\Omega$, $C_L = 100\text{ pF}$	6		6		MHz	
	Gain-bandwidth product	$R_L = 2\text{ k}\Omega$, $C_L = 100\text{ pF}$, $f = 100\text{ kHz}$	5.9		5.9		MHz	
B_{OM}	Maximum output-swing bandwidth	$V_{O(PP)} = 20\text{ V}$, $R_L = 2\text{ k}\Omega$, $A_{VD} = 1$, $C_L = 100\text{ pF}$	668		668		kHz	
ϕ_m	Phase margin at unity gain	$R_L = 2\text{ k}\Omega$, $C_L = 100\text{ pF}$	58°		58°			

TLE214x, TLE214xA EXCALIBUR LOW-NOISE HIGH-SPEED PRECISION OPERATIONAL AMPLIFIERS

SLOS183D – FEBRUARY 1997 – REVISED OCTOBER 2012

TLE2144M electrical characteristics at specified free-air temperature, $V_{CC} = 5\text{ V}$ (unless otherwise noted)

PARAMETER	TEST CONDITIONS	T_A^\dagger	TLE2144M			TLE2144AM			UNIT
			MIN	TYP	MAX	MIN	TYP	MAX	
V_{IO} Input offset voltage	$V_O = 2.5\text{ V}$, $V_{IC} = 2.5\text{ V}$	25°C	0.5	3.8		0.5	3	mV	
			Full range			5.2			4.4
α_{VIO} Temperature coefficient of input offset voltage		25°C	1.7			1.7			$\mu\text{V}/^\circ\text{C}$
I_{IO} Input offset current			25°C	8	100		8	100	nA
		Full range			250			250	
I_{IB} Input bias current		25°C	-0.8	-2		-0.8	-2	μA	
	Full range			-2.3			-2.3		
V_{ICR} Common-mode input voltage range	$R_S = 50\ \Omega$	25°C	0 to 3	-0.3 to 3.2		0 to 3	-0.3 to 3.2	V	
		Full range	0 to 2.7	-0.3 to 2.9		0 to 2.7	-0.3 to 2.9		
V_{OH} High-level output voltage	$I_{OH} = -150\ \mu\text{A}$	25°C	3.9	4.1		3.9	4.1	V	
	$I_{OH} = -1.5\text{ mA}$		3.8	4		3.8	4		
	$I_{OH} = -15\text{ mA}$		3.4	3.7		3.4	3.7		
	$I_{OH} = 100\ \mu\text{A}$	Full range	3.75			3.75			
	$I_{OH} = 1\text{ mA}$		3.65			3.65			
	$I_{OH} = 10\text{ mA}$		3.45			3.45			
V_{OL} Low-level output voltage	$I_{OL} = 150\ \mu\text{A}$	25°C	75	125		75	125	mV	
	$I_{OL} = 1.5\ \mu\text{A}$		150	225		150	225		
	$I_{OL} = 15\text{ mA}$		1.2	1.6		1.2	1.6	V	
	$I_{OL} = 100\ \mu\text{A}$	Full range	200			200			
	$I_{OL} = 1\text{ mA}$		250			250			
	$I_{OL} = 10\text{ mA}$		1.45			1.45			
A_{VD} Large-signal differential voltage amplification	$V_{IC} = \pm 2.5\text{ V}$, $V_O = 1\text{ V to } -1.5\text{ V}$	25°C	50	95		50	95	V/mV	
		Full range			5				
r_i Input resistance		25°C	70			70			M Ω
c_i Input capacitance		25°C	2.5			2.5			pF
z_o Open-loop output impedance	$f = 1\text{ MHz}$	25°C	30			30			Ω
CMRR Common-mode rejection ratio	$V_{IC} = V_{ICRmin}$, $R_S = 50\ \Omega$	25°C	85	118		85	118	dB	
		Full range			80				
k_{SVR} Supply-voltage rejection ratio ($\Delta V_{CC\pm}/\Delta V_{IO}$)	$V_{CC\pm} = \pm 2.5\text{ V to } \pm 15\text{ V}$, $R_S = 50\ \Omega$	25°C	90	106		90	106	dB	
		Full range			85				
I_{CC} Supply current	$V_O = 2.5\text{ V}$, $V_{IC} = 2.5\text{ V}$	25°C	13.2	17.6		13.2	17.6	mA	
		Full range			18.4				

† Full range is -55°C to 125°C .



TLE214x, TLE214xA
EXCALIBUR LOW-NOISE HIGH-SPEED
PRECISION OPERATIONAL AMPLIFIERS

SLOS183D – FEBRUARY 1997 – REVISED OCTOBER 2012

TLE2144M operating characteristics, $V_{CC} = 5\text{ V}$, $T_A = 25^\circ\text{C}$

PARAMETER	TEST CONDITIONS	TLE2144M			TLE2144AM			UNIT
		MIN	TYP	MAX	MIN	TYP	MAX	
SR+	Positive slew rate	$A_{VD} = -1$, $C_L = 500\text{ pF}$		$R_L = 2\text{ k}\Omega^\dagger$		45		V/ μs
SR-	Negative slew rate					42		
t_s	Settling time	$A_{VD} = -1$, 2.5-V step	To 0.1%		0.16		μs	
			To 0.01%		0.22			
V_n	Equivalent input noise voltage	$R_S = 20\ \Omega$, $f = 10\text{ Hz}$		15		nV/ $\sqrt{\text{Hz}}$		
		$R_S = 20\ \Omega$, $f = 1\text{ kHz}$		10.5				
$V_{N(PP)}$	Peak-to-peak equivalent input noise voltage	$f = 0.1\text{ Hz to }1\text{ Hz}$		0.48		μV		
		$f = 0.1\text{ Hz to }10\text{ Hz}$		0.51				
I_n	Equivalent input noise current	$f = 10\text{ Hz}$		1.92		pA/ $\sqrt{\text{Hz}}$		
		$f = 1\text{ kHz}$		0.5				
THD + N	Total harmonic distortion plus noise	$V_O = 1\text{ V to }3\text{ V}$, $A_{VD} = 2$, $R_L = 2\text{ k}\Omega^\dagger$, $f = 10\text{ kHz}$		0.0052%				
B_1	Unity-gain bandwidth	$R_L = 2\text{ k}\Omega^\dagger$, $C_L = 100\text{ pF}$		5.9		MHz		
	Gain-bandwidth product	$R_L = 2\text{ k}\Omega^\dagger$, $f = 100\text{ kHz}$, $C_L = 100\text{ pF}$		5.8		MHz		
B_{OM}	Maximum output-swing bandwidth	$V_{O(PP)} = 2\text{ V}$, $A_{VD} = 1$, $R_L = 2\text{ k}\Omega^\dagger$		660		kHz		
ϕ_m	Phase margin	$R_L = 2\text{ k}\Omega^\dagger$, $C_L = 100\text{ pF}$		57°				

$^\dagger R_L$ terminates at 2.5 V

TLE214x, TLE214xA EXCALIBUR LOW-NOISE HIGH-SPEED PRECISION OPERATIONAL AMPLIFIERS

SLOS183D – FEBRUARY 1997 – REVISED OCTOBER 2012

TLE2144M electrical characteristics at specified free-air temperature, $V_{CC\pm} = \pm 15\text{ V}$ (unless otherwise noted)

PARAMETER	TEST CONDITIONS	T_A^\dagger	TLE2144M			TLE2144AM			UNIT
			MIN	TYP	MAX	MIN	TYP	MAX	
V_{IO} Input offset voltage	$V_{IC} = 0, R_S = 50\ \Omega$	25°C	0.6	2.4		0.5	1.5	mV	
		Full range			4		3.2		
α_{VIO} Temperature coefficient of input offset voltage		Full range		1.7			1.7	$\mu\text{V}/^\circ\text{C}$	
I_{IO} Input offset current		25°C	7	100		7	100	nA	
		Full range			250		250		
I_{IB} Input bias current		25°C	-0.7	-1.5		-0.7	-1.5	μA	
	Full range			-1.8		-1.8			
V_{ICR} Common-mode input voltage range	$R_S = 50\ \Omega$	25°C	-15 to 13	-15.3 to 13.2		-15 to 13	-15.3 to 13.2	V	
		Full range	-15 to 12.7	-15.3 to 12.9		-15 to 12.7	-15.3 to 12.9		
V_{OM+} Maximum positive peak output voltage swing	$I_O = -150\ \mu\text{A}$ $I_O = -1.5\ \text{mA}$ $I_O = -15\ \text{mA}$ $I_O = -100\ \mu\text{A}$ $I_O = -1\ \text{mA}$ $I_O = -10\ \text{mA}$	25°C	13.8	14.1		13.8	14.1	V	
			13.7	14		13.7	14		
			13.1	13.7		13.1	13.7		
		Full range	13.7			13.7			
			13.6			13.6			
			13.1			13.1			
V_{OM-} Maximum negative peak output voltage swing	$I_O = 150\ \mu\text{A}$ $I_O = 1.5\ \text{mA}$ $I_O = 15\ \text{mA}$ $I_O = 100\ \mu\text{A}$ $I_O = 1\ \text{mA}$ $I_O = 10\ \text{mA}$	25°C	-14.7	-14.9		-14.7	-14.9	V	
			-14.5	-14.8		-14.5	-14.8		
			-13.4	-13.8		-13.4	-13.8		
		Full range	-14.6			-14.6			
			-14.5			-14.5			
			-13.4			-13.4			
A_{VD} Large-signal differential voltage amplification	$V_O = \pm 10\ \text{V}, R_L = 2\ \text{k}\Omega$	25°C	100	170		100	170	V/mV	
		Full range	20			20			
r_i Input resistance		25°C	65			65	$\text{M}\Omega$		
c_i Input capacitance		25°C	2.5			2.5	pF		
z_o Open-loop output impedance	$f = 1\ \text{MHz}$	25°C	30			30	Ω		
CMRR Common-mode rejection ratio	$V_{IC} = V_{ICRmin}, R_S = 50\ \Omega$	25°C	85	108		85	108	dB	
		Full range	80			80			
k_{SVR} Supply-voltage rejection ratio ($\Delta V_{CC\pm}/\Delta V_{IO}$)	$V_{CC\pm} = \pm 2.5\ \text{V to } \pm 15\ \text{V}, R_S = 50\ \Omega$	25°C	90	106		90	106	dB	
		Full range	85			85			
I_{OS} Short-circuit output current	$V_O = 0$	25°C	$V_{ID} = 1\ \text{V}$	-25	-50		-25	-50	mA
			$V_{ID} = -1\ \text{V}$	20	31		20	31	
I_{CC} Supply current	$V_O = 0, V_{IC} = 2.5\ \text{V}$	No load,	25°C	13.8	18		13.8	18	mA
			Full range			18.8		18.8	

† Full range is -55°C to 125°C



TLE214x, TLE214xA
EXCALIBUR LOW-NOISE HIGH-SPEED
PRECISION OPERATIONAL AMPLIFIERS

SLOS183D – FEBRUARY 1997 – REVISED OCTOBER 2012

TLE2144M operating characteristics, $V_{CC\pm} = \pm 15\text{ V}$, $T_A = 25^\circ\text{C}$

PARAMETER	TEST CONDITIONS	TLE2144M			TLE2144AM			UNIT	
		MIN	TYP	MAX	MIN	TYP	MAX		
SR+	Positive slew rate	$R_L = 2\text{ k}\Omega$, $C_L = 100\text{ pF}$		$A_{VD} = -1$,	27	45	27	45	V/ μs
SR-	Negative slew rate				27	42	27	42	
t_s	Settling time	$A_{VD} = -1$, 10-V step		To 0.1%	0.34			μs	
					To 0.01%				
V_n	Equivalent input noise voltage	$R_S = 20\ \Omega$,		$f = 10\text{ Hz}$	15			nV/ $\sqrt{\text{Hz}}$	
					$R_S = 20\ \Omega$,		$f = 1\text{ kHz}$		10.5
$V_{N(PP)}$	Peak-to-peak equivalent input noise voltage	$f = 0.1\text{ Hz to }1\text{ Hz}$		0.48			μV		
				$f = 0.1\text{ Hz to }10\text{ Hz}$		0.51			
I_n	Equivalent input noise current	$f = 10\text{ Hz}$		1.89			pA/ $\sqrt{\text{Hz}}$		
				$f = 10\text{ kHz}$		0.47			
THD + N	Total harmonic distortion plus noise	$V_{O(PP)} = 20\text{ V}$, $A_{VD} = 10$,		$R_L = 2\text{ k}\Omega$, $f = 10\text{ kHz}$	0.01%			0.01%	
B_1	Unity-gain bandwidth	$R_L = 2\text{ k}\Omega$,	$C_L = 100\text{ pF}$		6			MHz	
	Gain-bandwidth product	$R_L = 2\text{ k}\Omega$, $f = 100\text{ kHz}$	$C_L = 100\text{ pF}$,		5.9			MHz	
B_{OM}	Maximum output-swing bandwidth	$V_{O(PP)} = 20\text{ V}$, $A_{VD} = 1$,		$R_L = 2\text{ k}\Omega$, $C_L = 100\text{ pF}$	668			kHz	
ϕ_m	Phase margin at unity gain	$R_L = 2\text{ k}\Omega$,	$C_L = 100\text{ pF}$		58°			58°	

TLE214x, TLE214xA
EXCALIBUR LOW-NOISE HIGH-SPEED
PRECISION OPERATIONAL AMPLIFIERS

SLOS183D – FEBRUARY 1997 – REVISED OCTOBER 2012

TLE2141Y electrical characteristics at specified free-air temperature, $V_{CC\pm} = \pm 15\text{ V}$, $T_A = 25^\circ\text{C}$ (unless otherwise noted)

PARAMETER	TEST CONDITIONS	TLE2141Y			UNIT
		MIN	TYP	MAX	
V_{IO} Input offset voltage	$V_{IC} = 0,$ $V_O = 0$ $R_S = 50\ \Omega,$		200	1000	μV
I_{IO} Input offset current			7	100	nA
I_{IB} Input bias current			-0.7	-1.5	μA
V_{ICR} Common-mode input voltage range	$R_S = 50\ \Omega$	-15 to 13	-15.3 to 13.2		V
V_{OM+} Maximum positive peak output voltage swing	$I_O = -150\ \mu\text{A}$	13.8	14.1		V
	$I_O = -1.5\ \text{mA}$	13.7	14		
	$I_O = -15\ \text{mA}$	13.3	13.7		
V_{OM-} Maximum negative peak output voltage swing	$I_O = 150\ \mu\text{A}$	-14.7	-14.9		V
	$I_O = 1.5\ \text{mA}$	-14.5	-14.8		
	$I_O = 15\ \text{mA}$	-13.4	-13.8		
A_{VD} Large-signal differential voltage amplification	$V_O = \pm 10\ \text{V},$ $R_L = 2\ \text{k}\Omega$	100	450		V/mV
r_i Input resistance			65		$\text{M}\Omega$
c_i Input capacitance			2.5		pF
z_o Open-loop output impedance	$f = 1\ \text{MHz}$		30		Ω
CMRR Common-mode rejection ratio	$V_{IC} = V_{ICRmin},$ $R_S = 50\ \Omega$	80	108		dB
k_{SVR} Supply-voltage rejection ratio ($\Delta V_{CC\pm}/\Delta V_{IO}$)	$V_{CC\pm} = \pm 2.5\ \text{V to } \pm 15\ \text{V},$ $R_S = 50\ \Omega$	85	106		dB
I_{OS} Short-circuit output current	$V_O = 0$	$V_{ID} = 1\ \text{V}$	-25	-50	mA
		$V_{ID} = -1\ \text{V}$	20	31	
I_{CC} Supply current	$V_O = 0,$ No load		3.5	4.5	mA



TLE214x, TLE214xA
EXCALIBUR LOW-NOISE HIGH-SPEED
PRECISION OPERATIONAL AMPLIFIERS

SLOS183D – FEBRUARY 1997 – REVISED OCTOBER 2012

TLE2142Y electrical characteristics at specified free-air temperature, $V_{CC\pm} = \pm 15\text{ V}$, $T_A = 25^\circ\text{C}$

PARAMETER		TEST CONDITIONS	TLE2142Y			UNIT
			MIN	TYP	MAX	
V_{IO}	Input offset voltage	$V_{IC} = 0,$ $V_O = 0$ $R_S = 50\ \Omega$		150	875	μV
I_{IO}	Input offset current			7	100	nA
I_{IB}	Input bias current			-0.7	-1.5	μA
V_{ICR}	Common-mode input voltage range	$R_S = 50\ \Omega$	-15 to 13	-15.3 to 13.2		V
V_{OM+}	Maximum positive peak output voltage swing	$I_O = -150\ \mu\text{A}$	13.8	14.1		V
		$I_O = -1.5\ \text{mA}$	13.7	14		
		$I_O = -15\ \text{mA}$	13.3	13.7		
V_{OM-}	Maximum negative peak output voltage swing	$I_O = 150\ \mu\text{A}$	-14.7	-14.9		V
		$I_O = 1.5\ \text{mA}$	-14.5	-14.8		
		$I_O = 15\ \text{mA}$	-13.4	-13.8		
A_{VD}	Large-signal differential voltage amplification	$V_O = \pm 10\ \text{V},$ $R_L = 2\ \text{k}\Omega$	100	450		V/mV
r_i	Input resistance			65		M Ω
c_i	Input capacitance			2.5		pF
z_o	Open-loop output impedance	$f = 1\ \text{MHz}$		30		Ω
CMRR	Common-mode rejection ratio	$V_{IC} = V_{ICR\text{min}},$ $R_S = 50\ \Omega$	80	108		dB
k_{SVR}	Supply-voltage rejection ratio ($\Delta V_{CC\pm} / \Delta V_{IO}$)	$V_{CC\pm} = \pm 2.5\ \text{V to } \pm 15\ \text{V},$ $R_S = 50\ \Omega$	85	106		dB
I_{OS}	Short-circuit output current	$V_O = 0$	$V_{ID} = 1\ \text{V}$	-25	-50	mA
			$V_{ID} = -1\ \text{V}$	20	31	
I_{CC}	Supply current	$V_O = 0,$ No load		6.9	9	mA

TLE214x, TLE214xA EXCALIBUR LOW-NOISE HIGH-SPEED PRECISION OPERATIONAL AMPLIFIERS

SLOS183D – FEBRUARY 1997 – REVISED OCTOBER 2012

TLE2144Y electrical characteristics at $V_{CC\pm} = \pm 15\text{ V}$, $T_A = 25^\circ\text{C}$ (unless otherwise noted)

PARAMETER	TEST CONDITIONS	TLE2144Y			UNIT
		MIN	TYP	MAX	
V_{IO} Input offset voltage	$V_{IC} = 0$, $V_O = 0$, $R_S = 50\ \Omega$,	0.3	1.8		mV
I_{IO} Input offset current		7	100		nA
I_{IB} Input bias current		-0.7	-1.5		μA
V_{ICR} Common-mode input voltage range	$R_S = 50\ \Omega$	-15 to 13	-15.3 to 13.2		V
V_{OM+} Maximum positive peak output voltage swing	$I_O = -150\ \mu\text{A}$	13.8	14.1		V
	$I_O = -1.5\ \text{mA}$	13.7	14		
	$I_O = -15\ \text{mA}$	13.3	13.7		
V_{OM-} Maximum negative peak output voltage swing	$I_O = 150\ \mu\text{A}$	-14.7	-14.9		V
	$I_O = 1.5\ \text{mA}$	-14.5	-14.8		
	$I_O = 15\ \text{mA}$	-13.4	-13.8		
A_{VD} Large-signal differential voltage amplification	$V_O = \pm 10\ \text{V}$, $R_L = 2\ \text{k}\Omega$	100	450		V/mV
r_i Input resistance		65			$\text{M}\Omega$
c_i Input capacitance		2.5			pF
z_o Open-loop output impedance	$f = 1\ \text{MHz}$	30			Ω
CMRR Common-mode rejection ratio	$V_{IC} = V_{ICRmin}$, $R_S = 50\ \Omega$	80	108		dB
k_{SVR} Supply-voltage rejection ratio ($\Delta V_{CC\pm}/\Delta V_{IO}$)	$V_{CC\pm} = \pm 2.5\ \text{V}$ to $\pm 15\ \text{V}$, $R_S = 50\ \Omega$	85	106		dB
I_{OS} Short-circuit output current	$V_O = 0$	$V_{ID} = 1\ \text{V}$	-25	-50	mA
		$V_{ID} = -1\ \text{V}$	20	31	
I_{CC} Supply current	$V_O = 0$, No load	13.8	18		mA

TYPICAL CHARACTERISTICS

Table of Graphs

			FIGURE
V_{IO}	Input offset voltage	Distribution	1, 2, 3
I_{IO}	Input offset current	vs Free-air temperature	4
I_{IB}	Input bias current	vs Common-mode input voltage	5
		vs Free-air temperature	6
V_{OM+}	Maximum positive peak output voltage	vs Supply voltage	7
		vs Free-air temperature	8
		vs Output current	9
		vs Settling time	11
V_{OM-}	Maximum negative peak output voltage	vs Supply voltage	7
		vs Free-air temperature	8
		vs Output current	10
		vs Settling time	11
$V_{O(PP)}$	Maximum peak-to-peak output voltage	vs Frequency	12
V_{OH}	High-level output voltage	vs Output current	13
V_{OL}	Low-level output voltage	vs Output current	14
A_{VD}	Large-signal differential voltage amplification	vs Frequency	15
		vs Free-air temperature	16
z_o	Closed-loop output impedance	vs Frequency	17
I_{OS}	Short-circuit output current	vs Free-air temperature	18
CMRR	Common-mode rejection ratio	vs Frequency	19
		vs Free-air temperature	20
k_{SVR}	Supply-voltage rejection ratio	vs Frequency	21
		vs Free-air temperature	22
I_{CC}	Supply current	vs Supply voltage	23
		vs Free-air temperature	24
V_n	Equivalent input noise voltage	vs Frequency	25
V_n	Input noise voltage	Over a 10-second period	26
I_n	Noise current	vs Frequency	27
THD + N	Total harmonic distortion plus noise	vs Frequency	28
SR	Slew rate	vs Free-air temperature	29
		vs Load capacitance	30
Pulse response	Noninverting large signal	vs Time	31
	Inverting large signal	vs Time	32
	Small signal	vs Time	33
B_1	Unity-gain bandwidth	vs Load capacitance	34
	Gain margin	vs Load capacitance	35
ϕ_m	Phase margin	vs Load capacitance	36
	Phase shift	vs Frequency	15

TLE214x, TLE214xA EXCALIBUR LOW-NOISE HIGH-SPEED PRECISION OPERATIONAL AMPLIFIERS

SLOS183D – FEBRUARY 1997 – REVISED OCTOBER 2012

TYPICAL CHARACTERISTICS

**TLE2141
DISTRIBUTION OF
INPUT OFFSET VOLTAGE**

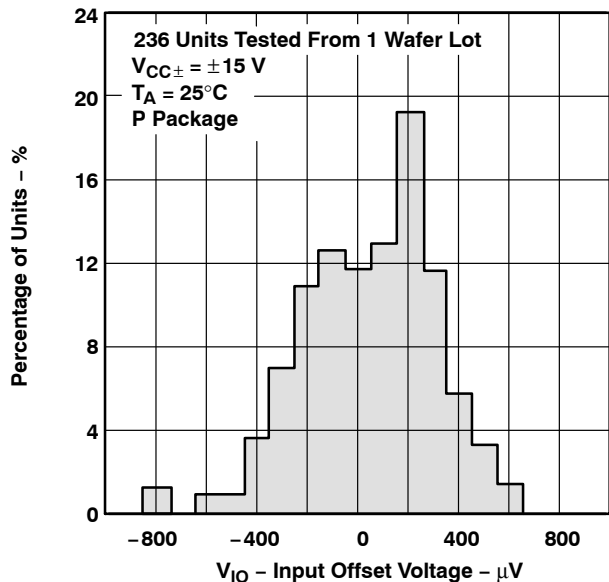

Figure 1

**TLE2142
DISTRIBUTION OF
INPUT OFFSET VOLTAGE**

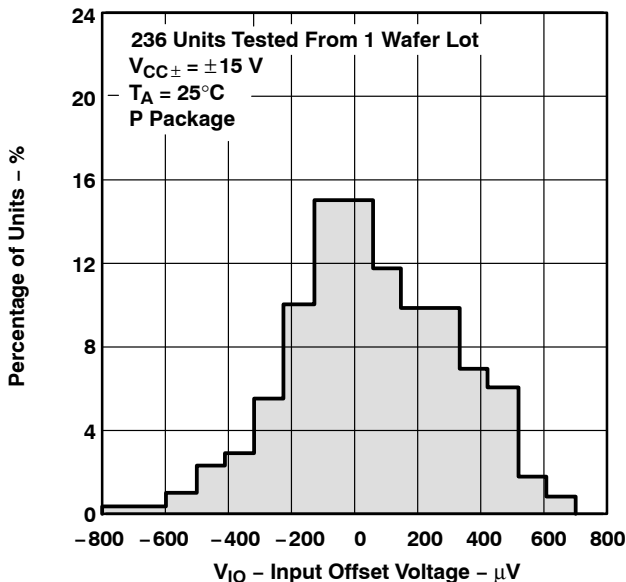

Figure 2

**TLE2144
DISTRIBUTION OF
INPUT OFFSET VOLTAGE**

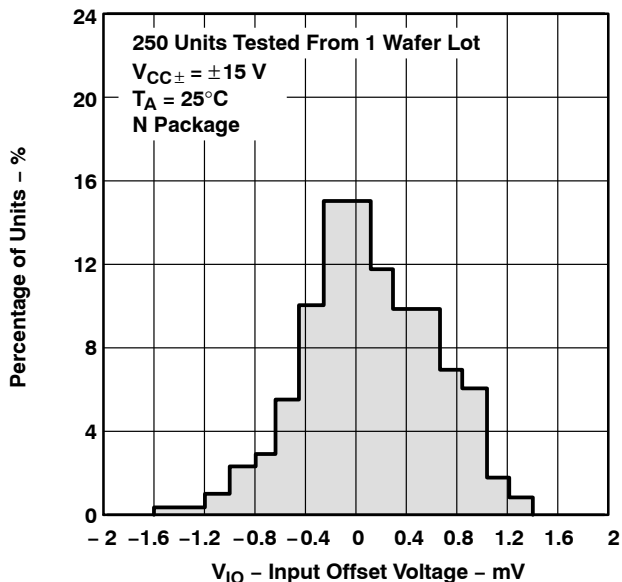

Figure 3

**INPUT OFFSET CURRENT†
vs
FREE-AIR TEMPERATURE**

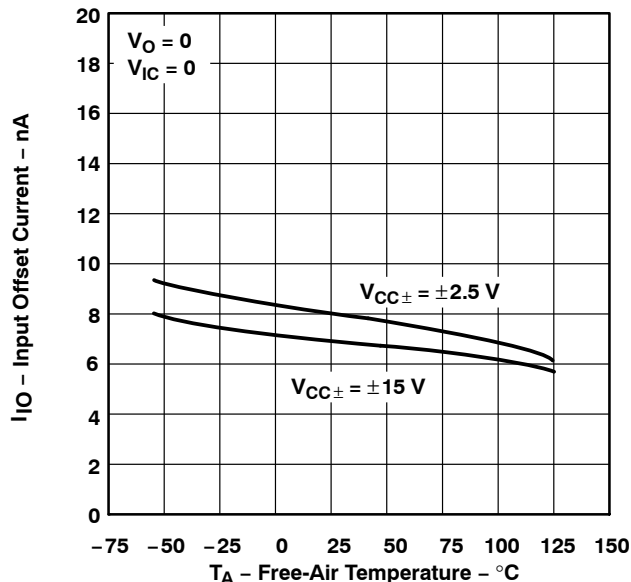
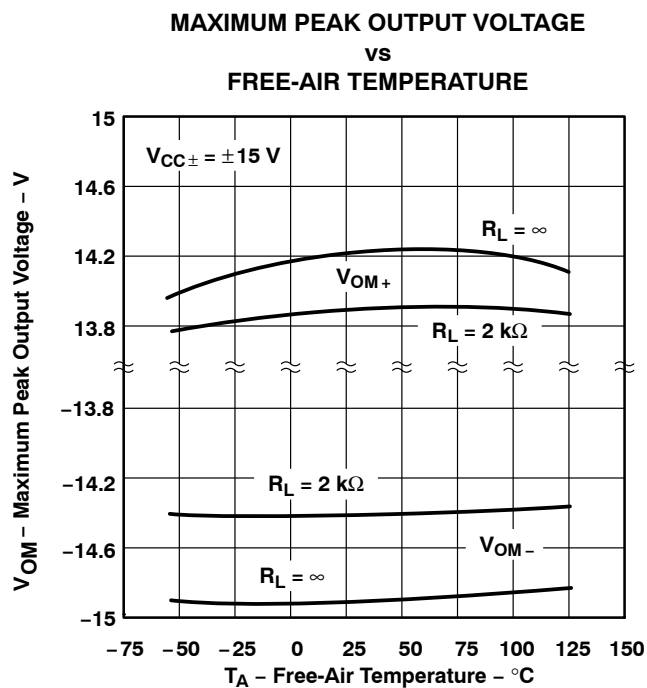
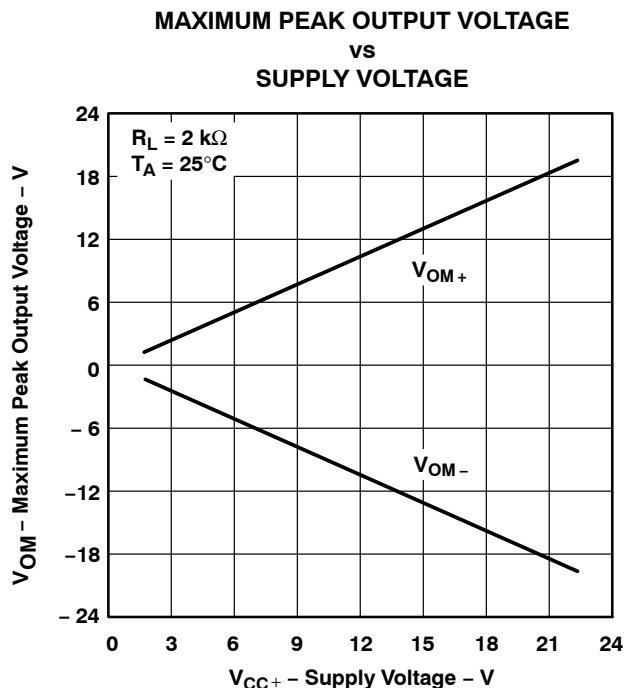
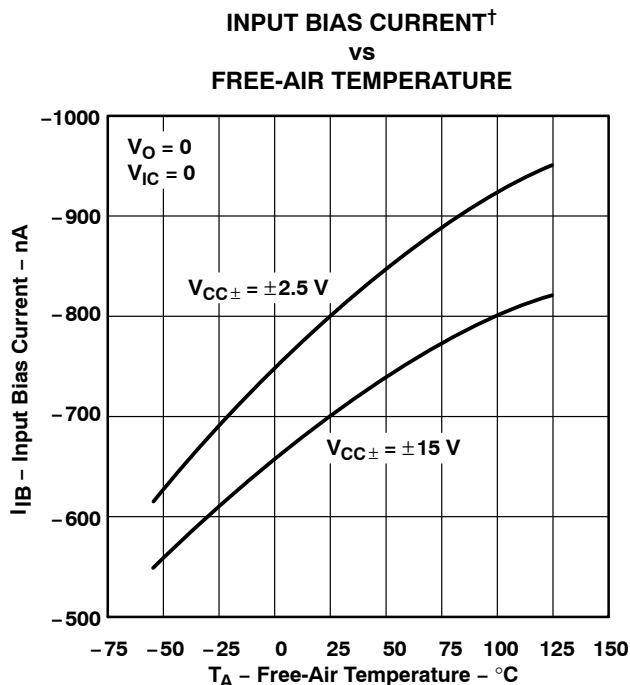
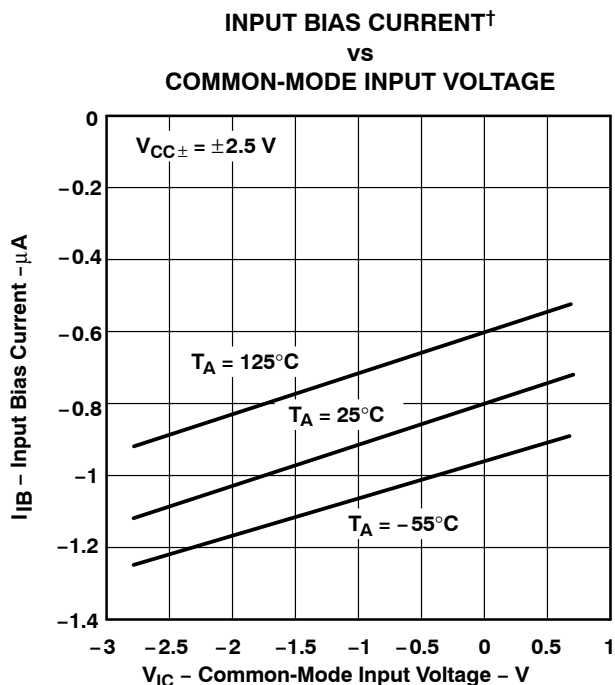

Figure 4

† Data at high and low temperatures are applicable only within the rated operating free-air temperature ranges of the various devices.

TYPICAL CHARACTERISTICS



† Data at high and low temperatures are applicable only within the rated operating free-air temperature ranges of the various devices.

TLE214x, TLE214xA
EXCALIBUR LOW-NOISE HIGH-SPEED
PRECISION OPERATIONAL AMPLIFIERS

SLOS183D – FEBRUARY 1997 – REVISED OCTOBER 2012

TYPICAL CHARACTERISTICS

MAXIMUM POSITIVE PEAK OUTPUT VOLTAGE[†]
vs
OUTPUT CURRENT

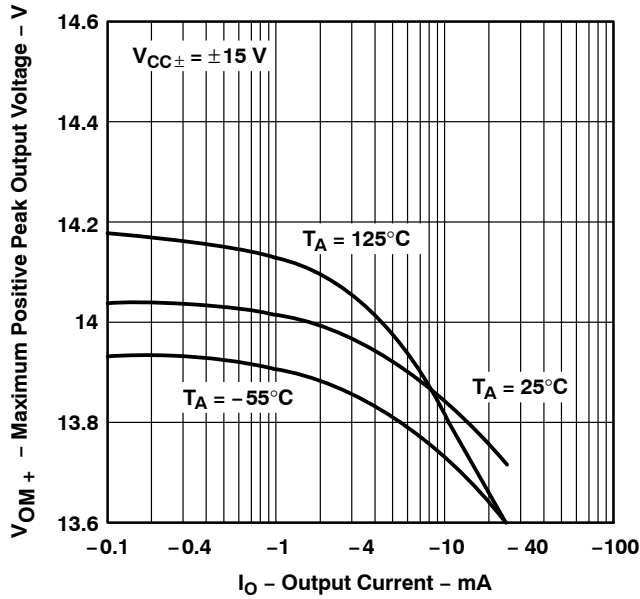

Figure 9

MAXIMUM NEGATIVE PEAK OUTPUT VOLTAGE[†]
vs
OUTPUT CURRENT

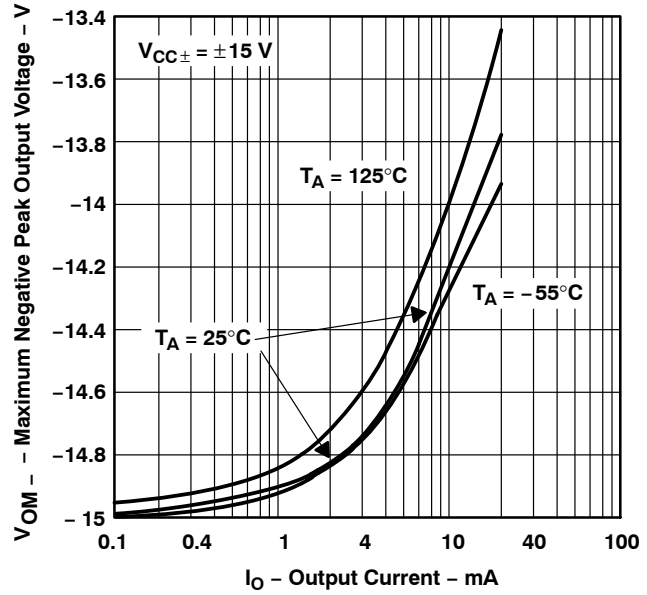

Figure 10

MAXIMUM PEAK OUTPUT VOLTAGE
vs
SETTLING TIME

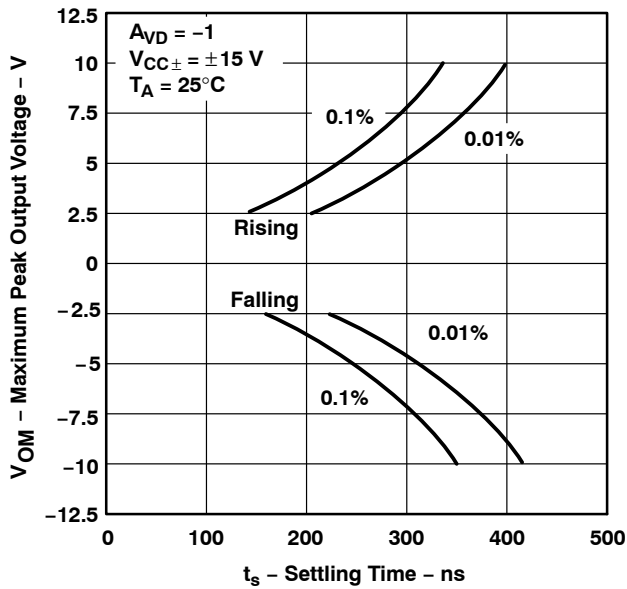

Figure 11

MAXIMUM PEAK-TO-PEAK OUTPUT VOLTAGE[†]
vs
FREQUENCY

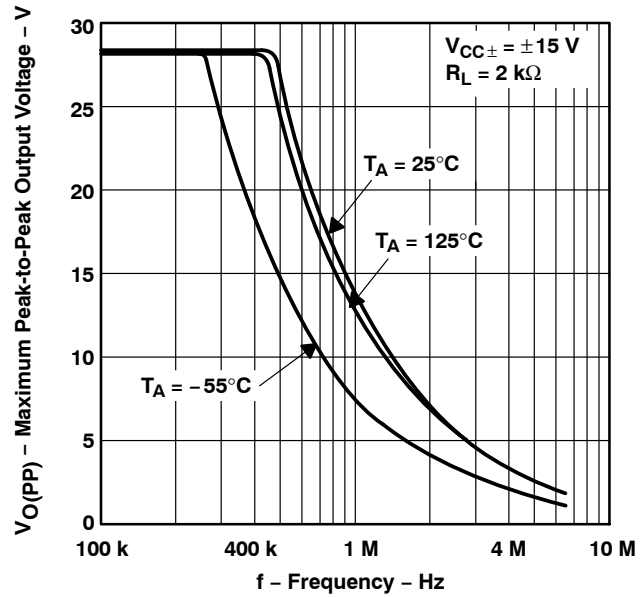

Figure 12

[†] Data at high and low temperatures are applicable only within the rated operating free-air temperature ranges of the various devices.



TYPICAL CHARACTERISTICS

**HIGH-LEVEL OUTPUT VOLTAGE[†]
 vs
 OUTPUT CURRENT**



Figure 13

**LOW-LEVEL OUTPUT VOLTAGE[†]
 vs
 OUTPUT CURRENT**



Figure 14

**LARGE-SIGNAL DIFFERENTIAL VOLTAGE
 AMPLIFICATION AND PHASE SHIFT
 vs
 FREQUENCY**



Figure 15

[†] Data at high and low temperatures are applicable only within the rated operating free-air temperature ranges of the various devices.

TLE214x, TLE214xA
EXCALIBUR LOW-NOISE HIGH-SPEED
PRECISION OPERATIONAL AMPLIFIERS

SLOS183D – FEBRUARY 1997 – REVISED OCTOBER 2012

TYPICAL CHARACTERISTICS

LARGE-SIGNAL DIFFERENTIAL VOLTAGE AMPLIFICATION†

vs

FREE-AIR TEMPERATURE

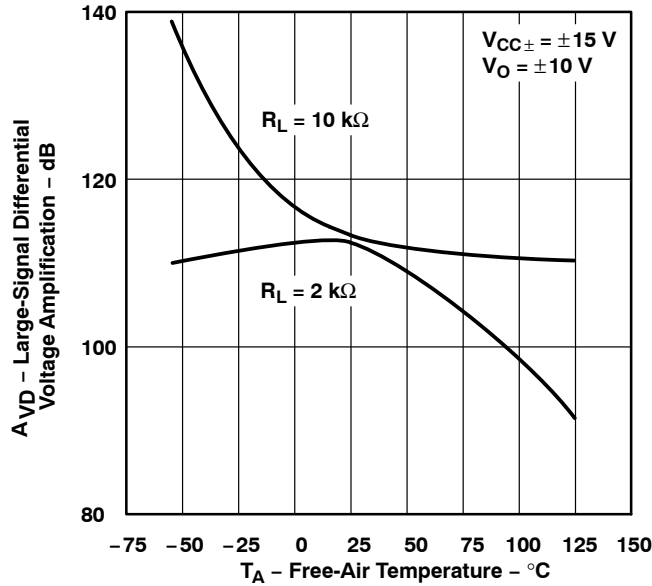

Figure 16

CLOSED-LOOP OUTPUT IMPEDANCE

vs

FREQUENCY

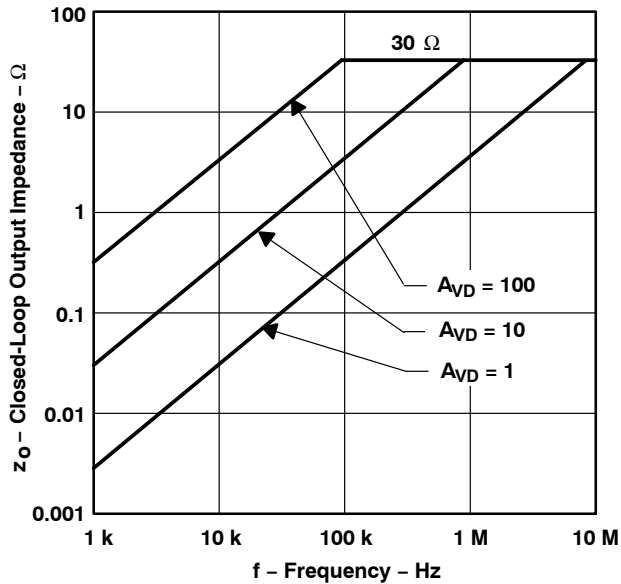

Figure 17

SHORT-CIRCUIT OUTPUT CURRENT†

vs

FREE-AIR TEMPERATURE

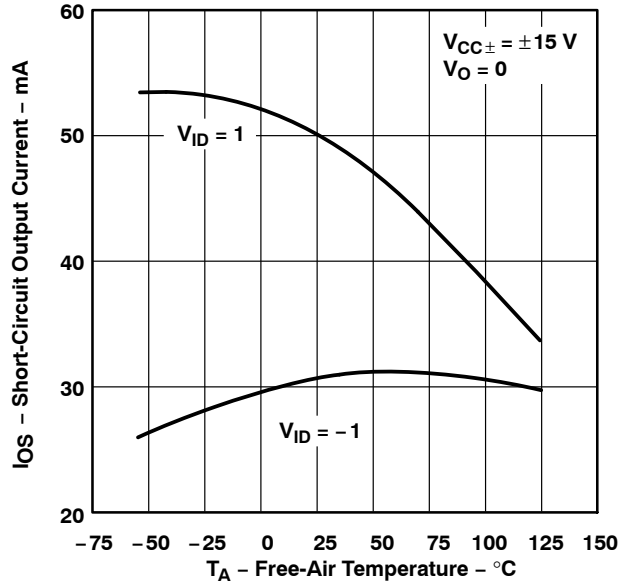

Figure 18

† Data at high and low temperatures are applicable only within the rated operating free-air temperature ranges of the various devices.



TYPICAL CHARACTERISTICS

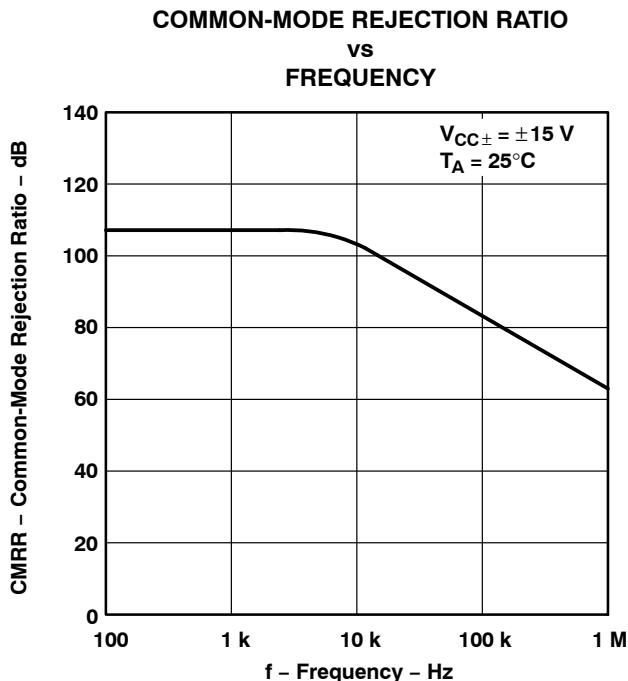

Figure 19

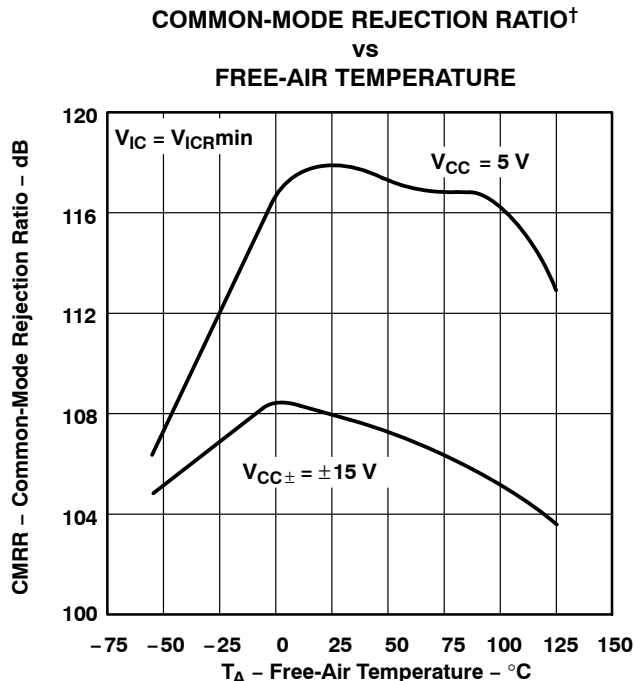

Figure 20

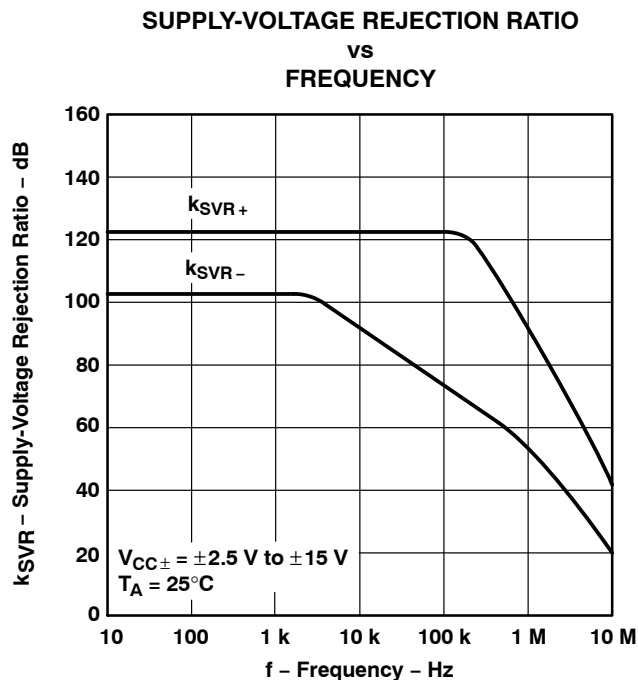

Figure 21

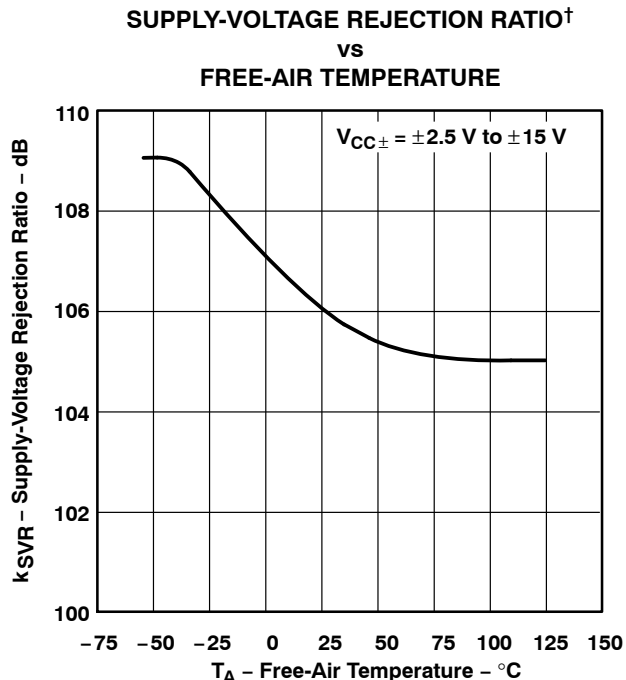

Figure 22

† Data at high and low temperatures are applicable only within the rated operating free-air temperature ranges of the various devices.

TLE214x, TLE214xA EXCALIBUR LOW-NOISE HIGH-SPEED PRECISION OPERATIONAL AMPLIFIERS

SLOS183D – FEBRUARY 1997 – REVISED OCTOBER 2012

TYPICAL CHARACTERISTICS

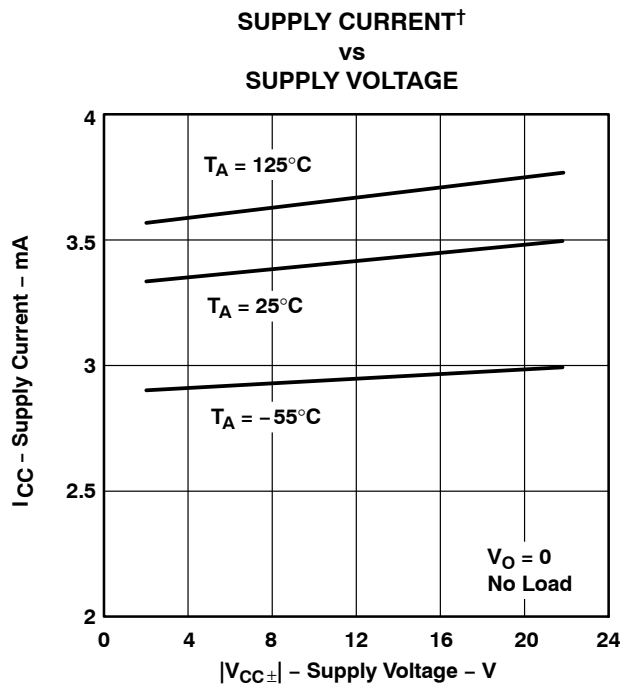

Figure 23

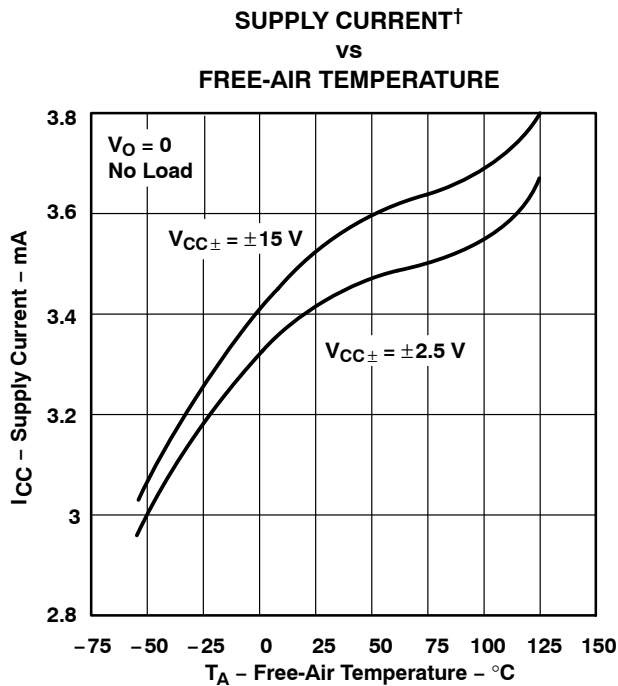

Figure 24

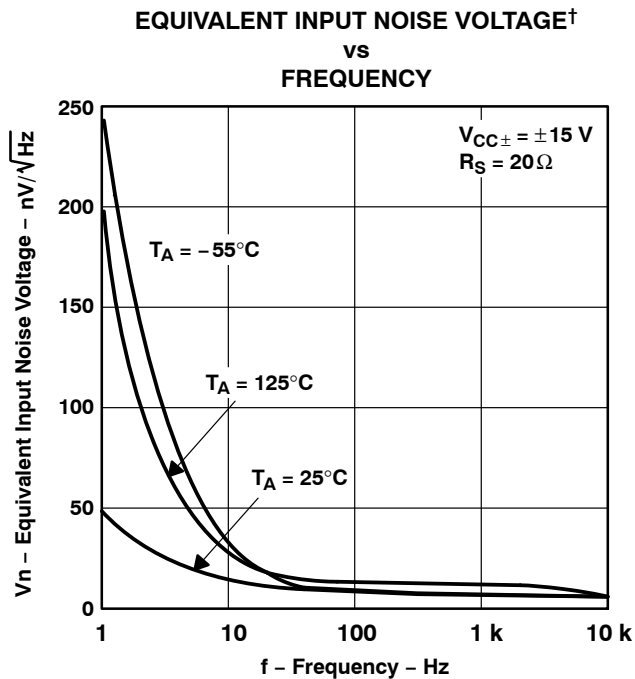

Figure 25

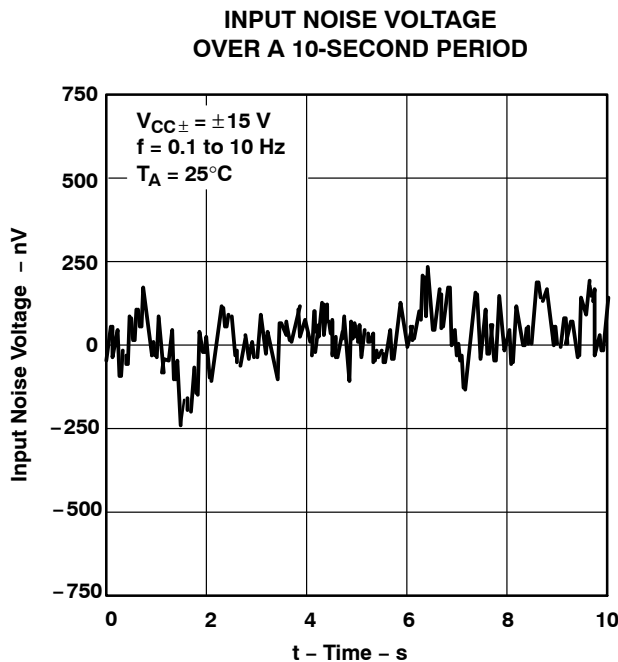
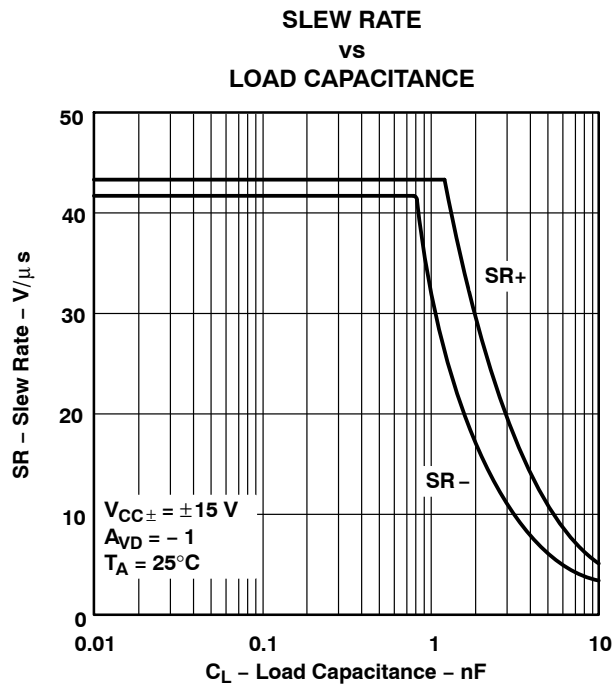
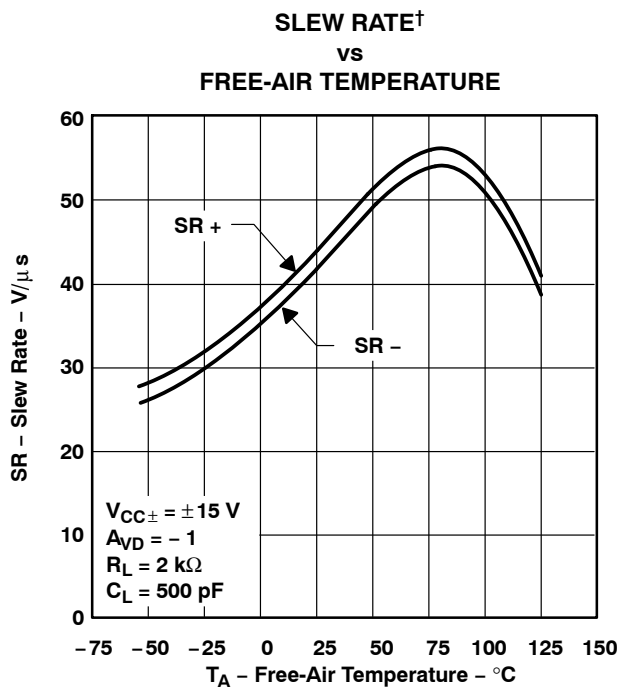
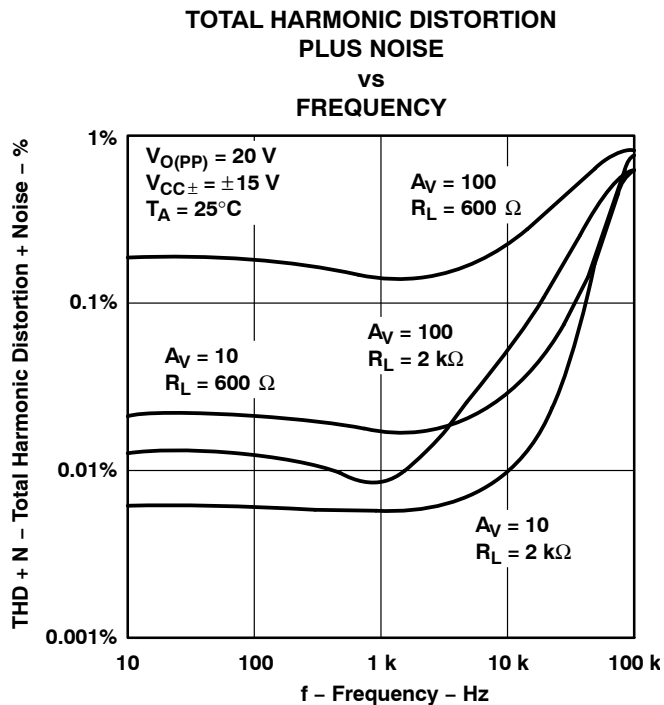
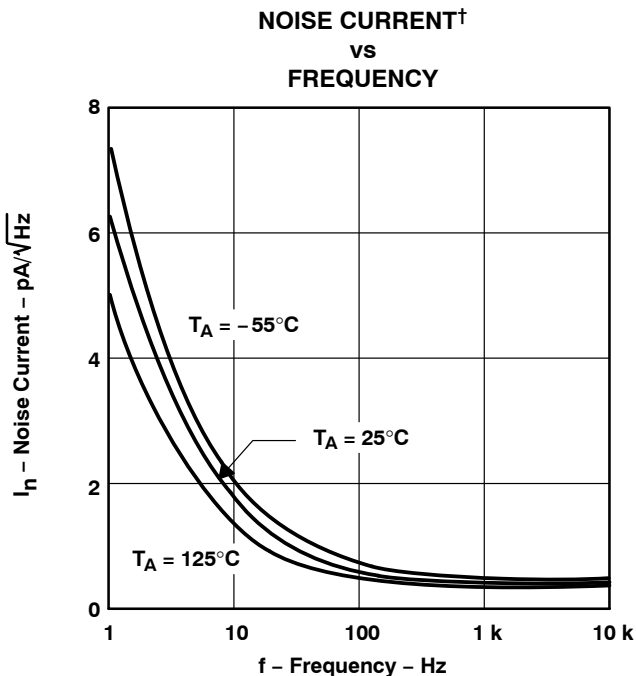

Figure 26

† Data at high and low temperatures are applicable only within the rated operating free-air temperature ranges of the various devices.

TYPICAL CHARACTERISTICS



† Data at high and low temperatures are applicable only within the rated operating free-air temperature ranges of the various devices.

TLE214x, TLE214xA
EXCALIBUR LOW-NOISE HIGH-SPEED
PRECISION OPERATIONAL AMPLIFIERS

SLOS183D – FEBRUARY 1997 – REVISED OCTOBER 2012

TYPICAL CHARACTERISTICS

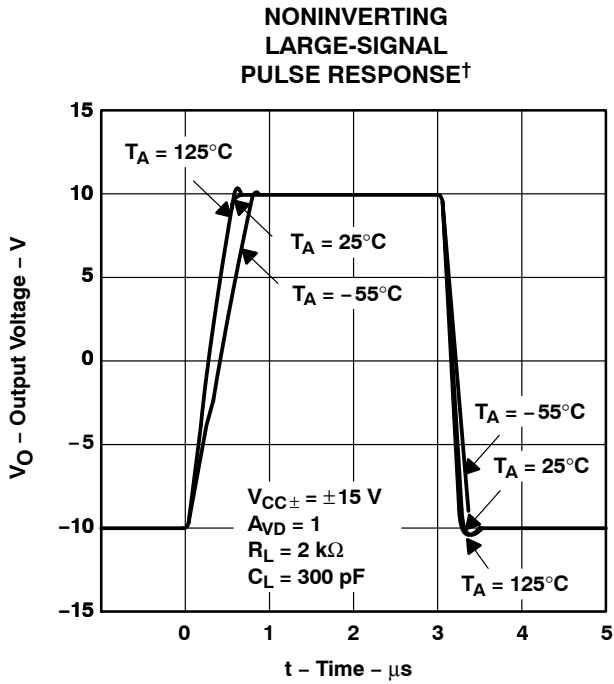

Figure 31

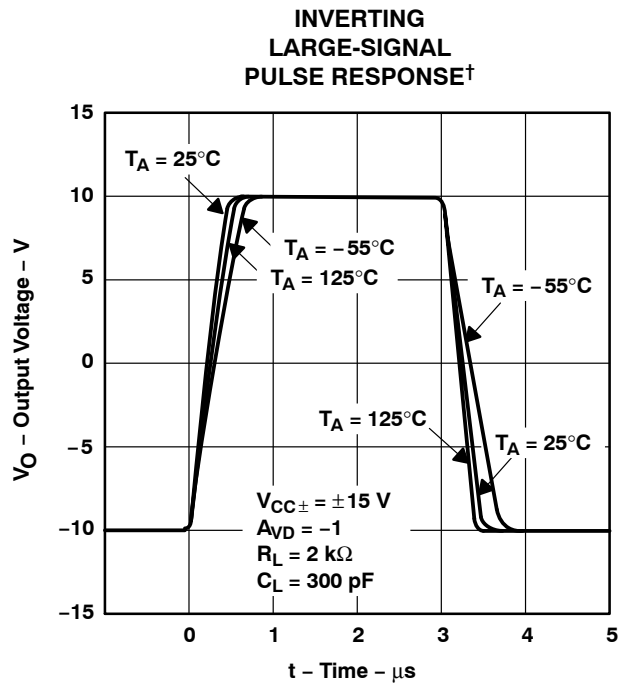

Figure 32

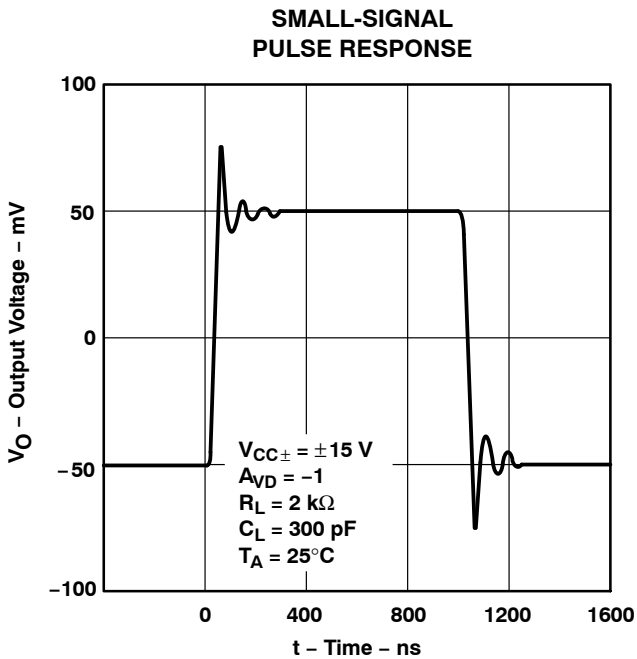

Figure 33

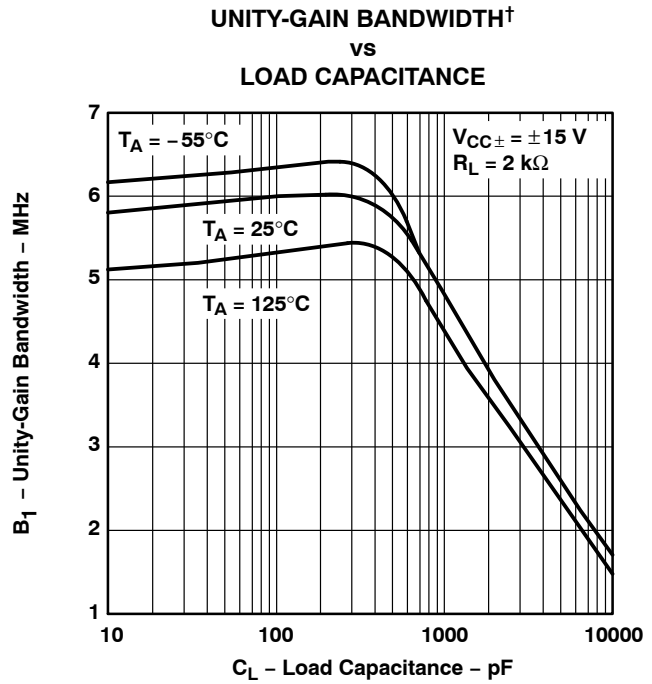

Figure 34

† Data at high and low temperatures are applicable only within the rated operating free-air temperature ranges of the various devices.

TYPICAL CHARACTERISTICS



Figure 35

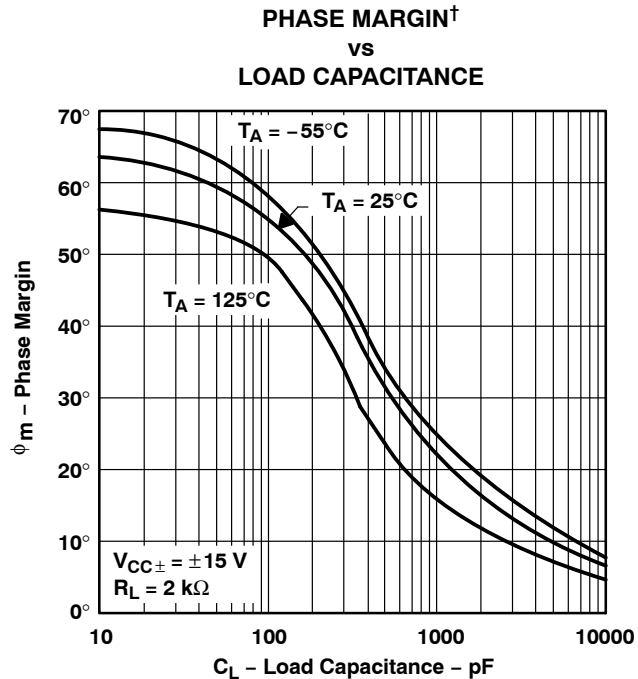

Figure 36

[†] Data at high and low temperatures are applicable only within the rated operating free-air temperature ranges of the various devices.

TLE214x, TLE214xA EXCALIBUR LOW-NOISE HIGH-SPEED PRECISION OPERATIONAL AMPLIFIERS

SLOS183D – FEBRUARY 1997 – REVISED OCTOBER 2012

APPLICATION INFORMATION

input offset voltage nulling

The TLE2141 series offers external null pins that can be used to further reduce the input offset voltage. If this feature is desired, connect the circuit of Figure 37 as shown. If external nulling is not needed, the null pins may be left unconnected.

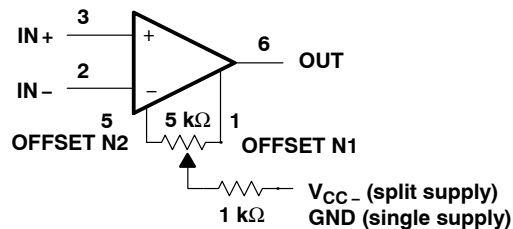

Figure 37. Input Offset Voltage Null Circuit

PACKAGING INFORMATION

Orderable Device	Status (1)	Package Type	Package Drawing	Pins	Package Qty	Eco Plan (2)	Lead/Ball Finish	MSL Peak Temp (3)	Op Temp (°C)	Top-Side Markings (4)	Samples
5962-9321603Q2A	ACTIVE	LCCC	FK	20	1	TBD	Call TI	Call TI	-55 to 125	5962- 9321603Q2A TLE2142MFKB	Samples
5962-9321603QHA	ACTIVE	CFP	U	10	1	TBD	Call TI	Call TI	-55 to 125	9321603QHA TLE2142M	Samples
5962-9321603QPA	ACTIVE	CDIP	JG	8	1	TBD	Call TI	Call TI	-55 to 125	9321603QPA TLE2142M	Samples
5962-9321604Q2A	ACTIVE	LCCC	FK	20	1	TBD	Call TI	Call TI	-55 to 125	5962- 9321604Q2A TLE2142 AMFKB	Samples
5962-9321604QHA	ACTIVE	CFP	U	10	1	TBD	Call TI	Call TI	-55 to 125	9321604QHA TLE2142AM	Samples
5962-9321604QPA	ACTIVE	CDIP	JG	8	1	TBD	Call TI	Call TI	-55 to 125	9321604QPA TLE2142AM	Samples
5962-9321605Q2A	ACTIVE	LCCC	FK	20	1	TBD	Call TI	Call TI	-55 to 125	5962- 9321605Q2A TLE2144MFKB	Samples
5962-9321605QCA	ACTIVE	CDIP	J	14	1	TBD	Call TI	Call TI	-55 to 125	5962-9321605QC A TLE2144MJB	Samples
5962-9321606Q2A	ACTIVE	LCCC	FK	20	1	TBD	Call TI	Call TI	-55 to 125	5962- 9321606Q2A TLE2144 AMFKB	Samples
5962-9321606QCA	ACTIVE	CDIP	J	14	1	TBD	Call TI	Call TI	-55 to 125	5962-9321606QC A TLE2144AMJB	Samples
TLE2141ACD	ACTIVE	SOIC	D	8	75	Green (RoHS & no Sb/Br)	CU NIPDAU	Level-1-260C-UNLIM		2141AC	Samples
TLE2141ACDG4	ACTIVE	SOIC	D	8	75	Green (RoHS & no Sb/Br)	CU NIPDAU	Level-1-260C-UNLIM		2141AC	Samples
TLE2141ACP	ACTIVE	PDIP	P	8	50	Pb-Free (RoHS)	CU NIPDAU	N / A for Pkg Type		TLE2141AC	Samples

Orderable Device	Status (1)	Package Type	Package Drawing	Pins	Package Qty	Eco Plan (2)	Lead/Ball Finish	MSL Peak Temp (3)	Op Temp (°C)	Top-Side Markings (4)	Samples
TLE2141ACPE4	ACTIVE	PDIP	P	8	50	Pb-Free (RoHS)	CU NIPDAU	N / A for Pkg Type		TLE2141AC	Samples
TLE2141AID	ACTIVE	SOIC	D	8	75	Green (RoHS & no Sb/Br)	CU NIPDAU	Level-1-260C-UNLIM		2141AI	Samples
TLE2141AIDG4	ACTIVE	SOIC	D	8	75	Green (RoHS & no Sb/Br)	CU NIPDAU	Level-1-260C-UNLIM		2141AI	Samples
TLE2141AIDR	ACTIVE	SOIC	D	8	2500	Green (RoHS & no Sb/Br)	CU NIPDAU	Level-1-260C-UNLIM		2141AI	Samples
TLE2141AIDRG4	ACTIVE	SOIC	D	8	2500	Green (RoHS & no Sb/Br)	CU NIPDAU	Level-1-260C-UNLIM		2141AI	Samples
TLE2141AIP	ACTIVE	PDIP	P	8	50	Pb-Free (RoHS)	CU NIPDAU	N / A for Pkg Type	0 to 70	TLE2141AI	Samples
TLE2141AIPE4	ACTIVE	PDIP	P	8	50	Pb-Free (RoHS)	CU NIPDAU	N / A for Pkg Type	0 to 70	TLE2141AI	Samples
TLE2141CD	ACTIVE	SOIC	D	8	75	Green (RoHS & no Sb/Br)	CU NIPDAU	Level-1-260C-UNLIM		2141C	Samples
TLE2141CDG4	ACTIVE	SOIC	D	8	75	Green (RoHS & no Sb/Br)	CU NIPDAU	Level-1-260C-UNLIM		2141C	Samples
TLE2141CDR	ACTIVE	SOIC	D	8	2500	Green (RoHS & no Sb/Br)	CU NIPDAU	Level-1-260C-UNLIM		2141C	Samples
TLE2141CDRG4	ACTIVE	SOIC	D	8	2500	Green (RoHS & no Sb/Br)	CU NIPDAU	Level-1-260C-UNLIM		2141C	Samples
TLE2141CP	ACTIVE	PDIP	P	8	50	Pb-Free (RoHS)	CU NIPDAU	N / A for Pkg Type		TLE2141CP	Samples
TLE2141CPE4	ACTIVE	PDIP	P	8	50	Pb-Free (RoHS)	CU NIPDAU	N / A for Pkg Type		TLE2141CP	Samples
TLE2141ID	ACTIVE	SOIC	D	8	75	Green (RoHS & no Sb/Br)	CU NIPDAU	Level-1-260C-UNLIM		2141I	Samples
TLE2141IDG4	ACTIVE	SOIC	D	8	75	Green (RoHS & no Sb/Br)	CU NIPDAU	Level-1-260C-UNLIM		2141I	Samples
TLE2141IDR	ACTIVE	SOIC	D	8	2500	Green (RoHS & no Sb/Br)	CU NIPDAU	Level-1-260C-UNLIM		2141I	Samples
TLE2141IDRG4	ACTIVE	SOIC	D	8	2500	Green (RoHS & no Sb/Br)	CU NIPDAU	Level-1-260C-UNLIM		2141I	Samples
TLE2141IP	ACTIVE	PDIP	P	8	50	Pb-Free (RoHS)	CU NIPDAU	N / A for Pkg Type		TLE2141IP	Samples

Orderable Device	Status (1)	Package Type	Package Drawing	Pins	Package Qty	Eco Plan (2)	Lead/Ball Finish	MSL Peak Temp (3)	Op Temp (°C)	Top-Side Markings (4)	Samples
TLE2141IPE4	ACTIVE	PDIP	P	8	50	Pb-Free (RoHS)	CU NIPDAU	N / A for Pkg Type		TLE2141IP	Samples
TLE2141MD	ACTIVE	SOIC	D	8	75	Green (RoHS & no Sb/Br)	CU NIPDAU	Level-1-260C-UNLIM	-55 to 125	2141M	Samples
TLE2141MDR	ACTIVE	SOIC	D	8	2500	Green (RoHS & no Sb/Br)	CU NIPDAU	Level-1-260C-UNLIM	-55 to 125	2141M	Samples
TLE2142ACD	ACTIVE	SOIC	D	8	75	Green (RoHS & no Sb/Br)	CU NIPDAU	Level-1-260C-UNLIM		2142AC	Samples
TLE2142ACDG4	ACTIVE	SOIC	D	8	75	Green (RoHS & no Sb/Br)	CU NIPDAU	Level-1-260C-UNLIM		2142AC	Samples
TLE2142ACDR	ACTIVE	SOIC	D	8	2500	Green (RoHS & no Sb/Br)	CU NIPDAU	Level-1-260C-UNLIM		2142AC	Samples
TLE2142ACDRG4	ACTIVE	SOIC	D	8	2500	Green (RoHS & no Sb/Br)	CU NIPDAU	Level-1-260C-UNLIM		2142AC	Samples
TLE2142ACP	OBSOLETE	PDIP	P	8		TBD	Call TI	Call TI	0 to 70		
TLE2142AID	ACTIVE	SOIC	D	8	75	Green (RoHS & no Sb/Br)	CU NIPDAU	Level-1-260C-UNLIM		2142AI	Samples
TLE2142AIDG4	ACTIVE	SOIC	D	8	75	Green (RoHS & no Sb/Br)	CU NIPDAU	Level-1-260C-UNLIM		2142AI	Samples
TLE2142AIDR	ACTIVE	SOIC	D	8	2500	Green (RoHS & no Sb/Br)	CU NIPDAU	Level-1-260C-UNLIM		2142AI	Samples
TLE2142AIDRG4	ACTIVE	SOIC	D	8	2500	Green (RoHS & no Sb/Br)	CU NIPDAU	Level-1-260C-UNLIM		2142AI	Samples
TLE2142AIP	OBSOLETE	PDIP	P	8		TBD	Call TI	Call TI			
TLE2142AMD	ACTIVE	SOIC	D	8	75	Green (RoHS & no Sb/Br)	CU NIPDAU	Level-1-260C-UNLIM	-55 to 125	E2142A	Samples
TLE2142AMDG4	ACTIVE	SOIC	D	8	75	Green (RoHS & no Sb/Br)	CU NIPDAU	Level-1-260C-UNLIM		E2142A	Samples
TLE2142AMDR	ACTIVE	SOIC	D	8	2500	Green (RoHS & no Sb/Br)	CU NIPDAU	Level-1-260C-UNLIM	-55 to 125	E2142A	Samples
TLE2142AMDRG4	ACTIVE	SOIC	D	8	2500	Green (RoHS & no Sb/Br)	CU NIPDAU	Level-1-260C-UNLIM		E2142A	Samples
TLE2142AMFKB	ACTIVE	LCCC	FK	20	1	TBD	POST-PLATE	N / A for Pkg Type	-55 to 125	5962-9321604Q2A TLE2142 AMFKB	Samples

Orderable Device	Status (1)	Package Type	Package Drawing	Pins	Package Qty	Eco Plan (2)	Lead/Ball Finish	MSL Peak Temp (3)	Op Temp (°C)	Top-Side Markings (4)	Samples
TLE2142AMJG	ACTIVE	CDIP	JG	8	1	TBD	A42	N / A for Pkg Type		TLE2142AMJG	Samples
TLE2142AMJGB	ACTIVE	CDIP	JG	8	1	TBD	A42	N / A for Pkg Type	-55 to 125	9321604QPA TLE2142AM	Samples
TLE2142AMUB	ACTIVE	CFP	U	10	1	TBD	A42	N / A for Pkg Type	-55 to 125	9321604QHA TLE2142AM	Samples
TLE2142CD	ACTIVE	SOIC	D	8	75	Green (RoHS & no Sb/Br)	CU NIPDAU	Level-1-260C-UNLIM		2142C	Samples
TLE2142CDG4	ACTIVE	SOIC	D	8	75	Green (RoHS & no Sb/Br)	CU NIPDAU	Level-1-260C-UNLIM		2142C	Samples
TLE2142CDR	ACTIVE	SOIC	D	8	2500	Green (RoHS & no Sb/Br)	CU NIPDAU	Level-1-260C-UNLIM		2142C	Samples
TLE2142CDRG4	ACTIVE	SOIC	D	8	2500	Green (RoHS & no Sb/Br)	CU NIPDAU	Level-1-260C-UNLIM		2142C	Samples
TLE2142CP	ACTIVE	PDIP	P	8	50	Pb-Free (RoHS)	CU NIPDAU	N / A for Pkg Type		TLE2142CP	Samples
TLE2142CPE4	ACTIVE	PDIP	P	8	50	Pb-Free (RoHS)	CU NIPDAU	N / A for Pkg Type		TLE2142CP	Samples
TLE2142CPWLE	OBSOLETE	TSSOP	PW	16		TBD	Call TI	Call TI			
TLE2142CPWR	ACTIVE	TSSOP	PW	16	2000	Green (RoHS & no Sb/Br)	CU NIPDAU	Level-1-260C-UNLIM		Q2142	Samples
TLE2142CPWRG4	ACTIVE	TSSOP	PW	16	2000	Green (RoHS & no Sb/Br)	CU NIPDAU	Level-1-260C-UNLIM		Q2142	Samples
TLE2142ID	ACTIVE	SOIC	D	8	75	Green (RoHS & no Sb/Br)	CU NIPDAU	Level-1-260C-UNLIM		2142I	Samples
TLE2142IDG4	ACTIVE	SOIC	D	8	75	Green (RoHS & no Sb/Br)	CU NIPDAU	Level-1-260C-UNLIM		2142I	Samples
TLE2142IDR	ACTIVE	SOIC	D	8	2500	Green (RoHS & no Sb/Br)	CU NIPDAU	Level-1-260C-UNLIM		2142I	Samples
TLE2142IDRG4	ACTIVE	SOIC	D	8	2500	Green (RoHS & no Sb/Br)	CU NIPDAU	Level-1-260C-UNLIM		2142I	Samples
TLE2142IP	ACTIVE	PDIP	P	8	50	Pb-Free (RoHS)	CU NIPDAU	N / A for Pkg Type		TLE2142IP	Samples
TLE2142IPE4	ACTIVE	PDIP	P	8	50	Pb-Free (RoHS)	CU NIPDAU	N / A for Pkg Type		TLE2142IP	Samples

Orderable Device	Status (1)	Package Type	Package Drawing	Pins	Package Qty	Eco Plan (2)	Lead/Ball Finish	MSL Peak Temp (3)	Op Temp (°C)	Top-Side Markings (4)	Samples
TLE2142MD	ACTIVE	SOIC	D	8	75	Green (RoHS & no Sb/Br)	CU NIPDAU	Level-1-260C-UNLIM	-55 to 125	2142M	Samples
TLE2142MDG4	ACTIVE	SOIC	D	8	75	Green (RoHS & no Sb/Br)	CU NIPDAU	Level-1-260C-UNLIM		2142M	Samples
TLE2142MDR	ACTIVE	SOIC	D	8	2500	Green (RoHS & no Sb/Br)	CU NIPDAU	Level-1-260C-UNLIM	-55 to 125	2142M	Samples
TLE2142MDRG4	ACTIVE	SOIC	D	8	2500	Green (RoHS & no Sb/Br)	CU NIPDAU	Level-1-260C-UNLIM		2142M	Samples
TLE2142MFKB	ACTIVE	LCCC	FK	20	1	TBD	POST-PLATE	N / A for Pkg Type	-55 to 125	5962-9321603Q2A TLE2142MFKB	Samples
TLE2142MJGB	ACTIVE	CDIP	JG	8	1	TBD	A42	N / A for Pkg Type	-55 to 125	9321603QPA TLE2142M	Samples
TLE2142MUB	ACTIVE	CFP	U	10	1	TBD	A42	N / A for Pkg Type	-55 to 125	9321603QHA TLE2142M	Samples
TLE2144ACN	ACTIVE	PDIP	N	14	25	Pb-Free (RoHS)	CU NIPDAU	N / A for Pkg Type		TLE2144ACN	Samples
TLE2144ACNE4	ACTIVE	PDIP	N	14	25	Pb-Free (RoHS)	CU NIPDAU	N / A for Pkg Type		TLE2144ACN	Samples
TLE2144AIN	ACTIVE	PDIP	N	14	25	Pb-Free (RoHS)	CU NIPDAU	N / A for Pkg Type		TLE2144AIN	Samples
TLE2144AINE4	ACTIVE	PDIP	N	14	25	Pb-Free (RoHS)	CU NIPDAU	N / A for Pkg Type		TLE2144AIN	Samples
TLE2144AMFKB	ACTIVE	LCCC	FK	20	1	TBD	POST-PLATE	N / A for Pkg Type	-55 to 125	5962-9321606Q2A TLE2144 AMFKB	Samples
TLE2144AMJB	ACTIVE	CDIP	J	14	1	TBD	A42	N / A for Pkg Type	-55 to 125	5962-9321606QC A TLE2144AMJB	Samples
TLE2144CDW	ACTIVE	SOIC	DW	16	40	Green (RoHS & no Sb/Br)	CU NIPDAU	Level-1-260C-UNLIM		TLE2144C	Samples
TLE2144CDWG4	ACTIVE	SOIC	DW	16	40	Green (RoHS & no Sb/Br)	CU NIPDAU	Level-1-260C-UNLIM		TLE2144C	Samples
TLE2144CDWR	ACTIVE	SOIC	DW	16	2000	Green (RoHS & no Sb/Br)	CU NIPDAU	Level-1-260C-UNLIM		TLE2144C	Samples

Orderable Device	Status (1)	Package Type	Package Drawing	Pins	Package Qty	Eco Plan (2)	Lead/Ball Finish	MSL Peak Temp (3)	Op Temp (°C)	Top-Side Markings (4)	Samples
TLE2144CDWRG4	ACTIVE	SOIC	DW	16	2000	Green (RoHS & no Sb/Br)	CU NIPDAU	Level-1-260C-UNLIM		TLE2144C	Samples
TLE2144CN	ACTIVE	PDIP	N	14	25	Pb-Free (RoHS)	CU NIPDAU	N / A for Pkg Type		TLE2144CN	Samples
TLE2144CNE4	ACTIVE	PDIP	N	14	25	Pb-Free (RoHS)	CU NIPDAU	N / A for Pkg Type		TLE2144CN	Samples
TLE2144IDW	ACTIVE	SOIC	DW	16	40	Green (RoHS & no Sb/Br)	CU NIPDAU	Level-1-260C-UNLIM		TLE2144I	Samples
TLE2144IDWG4	ACTIVE	SOIC	DW	16	40	Green (RoHS & no Sb/Br)	CU NIPDAU	Level-1-260C-UNLIM		TLE2144I	Samples
TLE2144IDWR	ACTIVE	SOIC	DW	16	2000	Green (RoHS & no Sb/Br)	CU NIPDAU	Level-1-260C-UNLIM		TLE2144I	Samples
TLE2144IDWRG4	ACTIVE	SOIC	DW	16	2000	Green (RoHS & no Sb/Br)	CU NIPDAU	Level-1-260C-UNLIM		TLE2144I	Samples
TLE2144IN	ACTIVE	PDIP	N	14	25	Pb-Free (RoHS)	CU NIPDAU	N / A for Pkg Type		TLE2144IN	Samples
TLE2144INE4	ACTIVE	PDIP	N	14	25	Pb-Free (RoHS)	CU NIPDAU	N / A for Pkg Type		TLE2144IN	Samples
TLE2144MDW	ACTIVE	SOIC	DW	16	40	Green (RoHS & no Sb/Br)	CU NIPDAU	Level-1-260C-UNLIM	-55 to 125	TLE2144M	Samples
TLE2144MDWG4	ACTIVE	SOIC	DW	16	40	Green (RoHS & no Sb/Br)	CU NIPDAU	Level-1-260C-UNLIM		TLE2144M	Samples
TLE2144MFKB	ACTIVE	LCCC	FK	20	1	TBD	POST-PLATE	N / A for Pkg Type	-55 to 125	5962-9321605Q2A TLE2144MFKB	Samples
TLE2144MJB	ACTIVE	CDIP	J	14	1	TBD	A42	N / A for Pkg Type	-55 to 125	5962-9321605QC A TLE2144MJB	Samples
TLE2144MN	OBSOLETE	PDIP	N	14		TBD	Call TI	Call TI	-55 to 125		

(1) The marketing status values are defined as follows:

ACTIVE: Product device recommended for new designs.

LIFEBUY: TI has announced that the device will be discontinued, and a lifetime-buy period is in effect.

NRND: Not recommended for new designs. Device is in production to support existing customers, but TI does not recommend using this part in a new design.

PREVIEW: Device has been announced but is not in production. Samples may or may not be available.

OBSOLETE: TI has discontinued the production of the device.

⁽²⁾ Eco Plan - The planned eco-friendly classification: Pb-Free (RoHS), Pb-Free (RoHS Exempt), or Green (RoHS & no Sb/Br) - please check <http://www.ti.com/productcontent> for the latest availability information and additional product content details.

TBD: The Pb-Free/Green conversion plan has not been defined.

Pb-Free (RoHS): TI's terms "Lead-Free" or "Pb-Free" mean semiconductor products that are compatible with the current RoHS requirements for all 6 substances, including the requirement that lead not exceed 0.1% by weight in homogeneous materials. Where designed to be soldered at high temperatures, TI Pb-Free products are suitable for use in specified lead-free processes.

Pb-Free (RoHS Exempt): This component has a RoHS exemption for either 1) lead-based flip-chip solder bumps used between the die and package, or 2) lead-based die adhesive used between the die and leadframe. The component is otherwise considered Pb-Free (RoHS compatible) as defined above.

Green (RoHS & no Sb/Br): TI defines "Green" to mean Pb-Free (RoHS compatible), and free of Bromine (Br) and Antimony (Sb) based flame retardants (Br or Sb do not exceed 0.1% by weight in homogeneous material)

⁽³⁾ MSL, Peak Temp. -- The Moisture Sensitivity Level rating according to the JEDEC industry standard classifications, and peak solder temperature.

⁽⁴⁾ Only one of markings shown within the brackets will appear on the physical device.

Important Information and Disclaimer: The information provided on this page represents TI's knowledge and belief as of the date that it is provided. TI bases its knowledge and belief on information provided by third parties, and makes no representation or warranty as to the accuracy of such information. Efforts are underway to better integrate information from third parties. TI has taken and continues to take reasonable steps to provide representative and accurate information but may not have conducted destructive testing or chemical analysis on incoming materials and chemicals. TI and TI suppliers consider certain information to be proprietary, and thus CAS numbers and other limited information may not be available for release.

In no event shall TI's liability arising out of such information exceed the total purchase price of the TI part(s) at issue in this document sold by TI to Customer on an annual basis.

OTHER QUALIFIED VERSIONS OF TLE2141, TLE2141A, TLE2142, TLE2142A, TLE2142AM, TLE2142M, TLE2144, TLE2144A, TLE2144AM, TLE2144M :

- Catalog: [TLE2142A](#), [TLE2142](#), [TLE2144A](#), [TLE2144](#)
- Automotive: [TLE2141-Q1](#), [TLE2142-Q1](#), [TLE2142-Q1](#)
- Enhanced Product: [TLE2141-EP](#), [TLE2144-EP](#), [TLE2144-EP](#)
- Military: [TLE2141M](#), [TLE2141AM](#), [TLE2142M](#), [TLE2142AM](#), [TLE2144M](#), [TLE2144AM](#)

NOTE: Qualified Version Definitions:

- Catalog - TI's standard catalog product
- Automotive - Q100 devices qualified for high-reliability automotive applications targeting zero defects
- Enhanced Product - Supports Defense, Aerospace and Medical Applications

- Military - QML certified for Military and Defense Applications

TAPE AND REEL INFORMATION

QUADRANT ASSIGNMENTS FOR PIN 1 ORIENTATION IN TAPE

*All dimensions are nominal

Device	Package Type	Package Drawing	Pins	SPQ	Reel Diameter (mm)	Reel Width W1 (mm)	A0 (mm)	B0 (mm)	K0 (mm)	P1 (mm)	W (mm)	Pin1 Quadrant
TLE2141AIDR	SOIC	D	8	2500	330.0	12.4	6.4	5.2	2.1	8.0	12.0	Q1
TLE2141CDR	SOIC	D	8	2500	330.0	12.4	6.4	5.2	2.1	8.0	12.0	Q1
TLE2141IDR	SOIC	D	8	2500	330.0	12.4	6.4	5.2	2.1	8.0	12.0	Q1
TLE2141MDR	SOIC	D	8	2500	330.0	12.4	6.4	5.2	2.1	8.0	12.0	Q1
TLE2142ACDR	SOIC	D	8	2500	330.0	12.4	6.4	5.2	2.1	8.0	12.0	Q1
TLE2142AIDR	SOIC	D	8	2500	330.0	12.4	6.4	5.2	2.1	8.0	12.0	Q1
TLE2142AMDR	SOIC	D	8	2500	330.0	12.4	6.4	5.2	2.1	8.0	12.0	Q1
TLE2142AMDRG4	SOIC	D	8	2500	330.0	12.4	6.4	5.2	2.1	8.0	12.0	Q1
TLE2142CDR	SOIC	D	8	2500	330.0	12.4	6.4	5.2	2.1	8.0	12.0	Q1
TLE2142CPWR	TSSOP	PW	16	2000	330.0	12.4	6.9	5.6	1.6	8.0	12.0	Q1
TLE2142IDR	SOIC	D	8	2500	330.0	12.4	6.4	5.2	2.1	8.0	12.0	Q1
TLE2142MDR	SOIC	D	8	2500	330.0	12.4	6.4	5.2	2.1	8.0	12.0	Q1
TLE2142MDRG4	SOIC	D	8	2500	330.0	12.4	6.4	5.2	2.1	8.0	12.0	Q1
TLE2144CDWR	SOIC	DW	16	2000	330.0	16.4	10.75	10.7	2.7	12.0	16.0	Q1
TLE2144IDWR	SOIC	DW	16	2000	330.0	16.4	10.75	10.7	2.7	12.0	16.0	Q1

TAPE AND REEL BOX DIMENSIONS

*All dimensions are nominal

Device	Package Type	Package Drawing	Pins	SPQ	Length (mm)	Width (mm)	Height (mm)
TLE2141AIDR	SOIC	D	8	2500	340.5	338.1	20.6
TLE2141CDR	SOIC	D	8	2500	340.5	338.1	20.6
TLE2141IDR	SOIC	D	8	2500	340.5	338.1	20.6
TLE2141MDR	SOIC	D	8	2500	367.0	367.0	35.0
TLE2142ACDR	SOIC	D	8	2500	340.5	338.1	20.6
TLE2142AIDR	SOIC	D	8	2500	340.5	338.1	20.6
TLE2142AMDR	SOIC	D	8	2500	367.0	367.0	35.0
TLE2142AMDRG4	SOIC	D	8	2500	367.0	367.0	35.0
TLE2142CDR	SOIC	D	8	2500	340.5	338.1	20.6
TLE2142CPWR	TSSOP	PW	16	2000	367.0	367.0	35.0
TLE2142IDR	SOIC	D	8	2500	340.5	338.1	20.6
TLE2142MDR	SOIC	D	8	2500	367.0	367.0	35.0
TLE2142MDRG4	SOIC	D	8	2500	367.0	367.0	35.0
TLE2144CDWR	SOIC	DW	16	2000	367.0	367.0	38.0
TLE2144IDWR	SOIC	DW	16	2000	367.0	367.0	38.0

JG (R-GDIP-T8)

CERAMIC DUAL-IN-LINE



- NOTES: A. All linear dimensions are in inches (millimeters).
 B. This drawing is subject to change without notice.
 C. This package can be hermetically sealed with a ceramic lid using glass frit.
 D. Index point is provided on cap for terminal identification.
 E. Falls within MIL STD 1835 GDIP1-T8

J (R-GDIP-T**)

14 LEADS SHOWN

CERAMIC DUAL IN-LINE PACKAGE



DIM \ PINS **	14	16	18	20
A	0.300 (7,62) BSC	0.300 (7,62) BSC	0.300 (7,62) BSC	0.300 (7,62) BSC
B MAX	0.785 (19,94)	.840 (21,34)	0.960 (24,38)	1.060 (26,92)
B MIN	—	—	—	—
C MAX	0.300 (7,62)	0.300 (7,62)	0.310 (7,87)	0.300 (7,62)
C MIN	0.245 (6,22)	0.245 (6,22)	0.220 (5,59)	0.245 (6,22)



4040083/F 03/03

- NOTES:
- All linear dimensions are in inches (millimeters).
 - This drawing is subject to change without notice.
 - This package is hermetically sealed with a ceramic lid using glass frit.
 - Index point is provided on cap for terminal identification only on press ceramic glass frit seal only.
 - Falls within MIL STD 1835 GDIP1-T14, GDIP1-T16, GDIP1-T18 and GDIP1-T20.

FK (S-CQCC-N**)

LEADLESS CERAMIC CHIP CARRIER

28 TERMINAL SHOWN



NO. OF TERMINALS **	A		B	
	MIN	MAX	MIN	MAX
20	0.342 (8,69)	0.358 (9,09)	0.307 (7,80)	0.358 (9,09)
28	0.442 (11,23)	0.458 (11,63)	0.406 (10,31)	0.458 (11,63)
44	0.640 (16,26)	0.660 (16,76)	0.495 (12,58)	0.560 (14,22)
52	0.740 (18,78)	0.761 (19,32)	0.495 (12,58)	0.560 (14,22)
68	0.938 (23,83)	0.962 (24,43)	0.850 (21,6)	0.858 (21,8)
84	1.141 (28,99)	1.165 (29,59)	1.047 (26,6)	1.063 (27,0)



4040140/D 01/11

- NOTES:
- All linear dimensions are in inches (millimeters).
 - This drawing is subject to change without notice.
 - This package can be hermetically sealed with a metal lid.
 - Falls within JEDEC MS-004

P (R-PDIP-T8)

PLASTIC DUAL-IN-LINE PACKAGE



- NOTES:
- A. All linear dimensions are in inches (millimeters).
 - B. This drawing is subject to change without notice.
 - C. Falls within JEDEC MS-001 variation BA.

PW (R-PDSO-G16)

PLASTIC SMALL OUTLINE



- NOTES:
- A. All linear dimensions are in millimeters.
 - B. This drawing is subject to change without notice.
 - C. Publication IPC-7351 is recommended for alternate designs.
 - D. Laser cutting apertures with trapezoidal walls and also rounding corners will offer better paste release. Customers should contact their board assembly site for stencil design recommendations. Refer to IPC-7525 for other stencil recommendations.
 - E. Customers should contact their board fabrication site for solder mask tolerances between and around signal pads.

D (R-PDSO-G8)

PLASTIC SMALL OUTLINE



- NOTES:
- All linear dimensions are in millimeters.
 - This drawing is subject to change without notice.
 - Publication IPC-7351 is recommended for alternate designs.
 - Laser cutting apertures with trapezoidal walls and also rounding corners will offer better paste release. Customers should contact their board assembly site for stencil design recommendations. Refer to IPC-7525 for other stencil recommendations.
 - Customers should contact their board fabrication site for solder mask tolerances between and around signal pads.

DW (R-PDSO-G16)

PLASTIC SMALL OUTLINE



4040000-2/G 01/11

- NOTES:
- A. All linear dimensions are in inches (millimeters). Dimensioning and tolerancing per ASME Y14.5M-1994.
 - B. This drawing is subject to change without notice.
 - C. Body dimensions do not include mold flash or protrusion not to exceed 0.006 (0,15).
 - D. Falls within JEDEC MS-013 variation AA.

IMPORTANT NOTICE

Texas Instruments Incorporated and its subsidiaries (TI) reserve the right to make corrections, enhancements, improvements and other changes to its semiconductor products and services per JESD46, latest issue, and to discontinue any product or service per JESD48, latest issue. Buyers should obtain the latest relevant information before placing orders and should verify that such information is current and complete. All semiconductor products (also referred to herein as "components") are sold subject to TI's terms and conditions of sale supplied at the time of order acknowledgment.

TI warrants performance of its components to the specifications applicable at the time of sale, in accordance with the warranty in TI's terms and conditions of sale of semiconductor products. Testing and other quality control techniques are used to the extent TI deems necessary to support this warranty. Except where mandated by applicable law, testing of all parameters of each component is not necessarily performed.

TI assumes no liability for applications assistance or the design of Buyers' products. Buyers are responsible for their products and applications using TI components. To minimize the risks associated with Buyers' products and applications, Buyers should provide adequate design and operating safeguards.

TI does not warrant or represent that any license, either express or implied, is granted under any patent right, copyright, mask work right, or other intellectual property right relating to any combination, machine, or process in which TI components or services are used. Information published by TI regarding third-party products or services does not constitute a license to use such products or services or a warranty or endorsement thereof. Use of such information may require a license from a third party under the patents or other intellectual property of the third party, or a license from TI under the patents or other intellectual property of TI.

Reproduction of significant portions of TI information in TI data books or data sheets is permissible only if reproduction is without alteration and is accompanied by all associated warranties, conditions, limitations, and notices. TI is not responsible or liable for such altered documentation. Information of third parties may be subject to additional restrictions.

Resale of TI components or services with statements different from or beyond the parameters stated by TI for that component or service voids all express and any implied warranties for the associated TI component or service and is an unfair and deceptive business practice. TI is not responsible or liable for any such statements.

Buyer acknowledges and agrees that it is solely responsible for compliance with all legal, regulatory and safety-related requirements concerning its products, and any use of TI components in its applications, notwithstanding any applications-related information or support that may be provided by TI. Buyer represents and agrees that it has all the necessary expertise to create and implement safeguards which anticipate dangerous consequences of failures, monitor failures and their consequences, lessen the likelihood of failures that might cause harm and take appropriate remedial actions. Buyer will fully indemnify TI and its representatives against any damages arising out of the use of any TI components in safety-critical applications.

In some cases, TI components may be promoted specifically to facilitate safety-related applications. With such components, TI's goal is to help enable customers to design and create their own end-product solutions that meet applicable functional safety standards and requirements. Nonetheless, such components are subject to these terms.

No TI components are authorized for use in FDA Class III (or similar life-critical medical equipment) unless authorized officers of the parties have executed a special agreement specifically governing such use.

Only those TI components which TI has specifically designated as military grade or "enhanced plastic" are designed and intended for use in military/aerospace applications or environments. Buyer acknowledges and agrees that any military or aerospace use of TI components which have **not** been so designated is solely at the Buyer's risk, and that Buyer is solely responsible for compliance with all legal and regulatory requirements in connection with such use.

TI has specifically designated certain components as meeting ISO/TS16949 requirements, mainly for automotive use. In any case of use of non-designated products, TI will not be responsible for any failure to meet ISO/TS16949.

Products

Audio	www.ti.com/audio
Amplifiers	amplifier.ti.com
Data Converters	dataconverter.ti.com
DLP® Products	www.dlp.com
DSP	dsp.ti.com
Clocks and Timers	www.ti.com/clocks
Interface	interface.ti.com
Logic	logic.ti.com
Power Mgmt	power.ti.com
Microcontrollers	microcontroller.ti.com
RFID	www.ti-rfid.com
OMAP Applications Processors	www.ti.com/omap
Wireless Connectivity	www.ti.com/wirelessconnectivity

Applications

Automotive and Transportation	www.ti.com/automotive
Communications and Telecom	www.ti.com/communications
Computers and Peripherals	www.ti.com/computers
Consumer Electronics	www.ti.com/consumer-apps
Energy and Lighting	www.ti.com/energy
Industrial	www.ti.com/industrial
Medical	www.ti.com/medical
Security	www.ti.com/security
Space, Avionics and Defense	www.ti.com/space-avionics-defense
Video and Imaging	www.ti.com/video

TI E2E Community

e2e.ti.com

AMEYA360

Components Supply Platform

Authorized Distribution Brand :



Website :

Welcome to visit www.ameya360.com

Contact Us :

➤ Address :

401 Building No.5, JiuGe Business Center, Lane 2301, Yishan Rd
Minhang District, Shanghai , China

➤ Sales :

Direct +86 (21) 6401-6692

Email amall@ameya360.com

QQ 800077892

Skype [ameyasales1](#) [ameyasales2](#)

➤ Customer Service :

Email service@ameya360.com

➤ Partnership :

Tel +86 (21) 64016692-8333

Email mkt@ameya360.com