

# NVMFS5C404NL

## Power MOSFET

40 V, 0.75 mΩ, 352 A, Single N-Channel

### Features

- Small Footprint (5x6 mm) for Compact Design
- Low  $R_{DS(on)}$  to Minimize Conduction Losses
- Low  $Q_G$  and Capacitance to Minimize Driver Losses
- NVMFS5C404NLWF – Wettable Flank Option for Enhanced Optical Inspection
- AEC-Q101 Qualified and PPAP Capable
- These Devices are Pb-Free and are RoHS Compliant

### MAXIMUM RATINGS ( $T_J = 25^\circ\text{C}$ unless otherwise noted)

Parameter	Symbol	Value	Unit	
Drain-to-Source Voltage	$V_{DSS}$	40	V	
Gate-to-Source Voltage	$V_{GS}$	$\pm 16$	V	
Continuous Drain Current $R_{\theta JC}$ (Notes 1, 3)	Steady State	$T_C = 25^\circ\text{C}$	$I_D$ 352	A
		$T_C = 100^\circ\text{C}$	249	
Power Dissipation $R_{\theta JC}$ (Note 1)	Steady State	$T_C = 25^\circ\text{C}$	$P_D$ 200	W
		$T_C = 100^\circ\text{C}$	100	
Continuous Drain Current $R_{\theta JA}$ (Notes 1, 2, 3)	Steady State	$T_A = 25^\circ\text{C}$	$I_D$ 49	A
		$T_A = 100^\circ\text{C}$	35	
Power Dissipation $R_{\theta JA}$ (Notes 1 & 2)	Steady State	$T_A = 25^\circ\text{C}$	$P_D$ 3.9	W
		$T_A = 100^\circ\text{C}$	1.9	
Pulsed Drain Current	$T_A = 25^\circ\text{C}, t_p = 10 \mu\text{s}$	$I_{DM}$ 900	A	
Operating Junction and Storage Temperature	$T_J, T_{stg}$	-55 to +175	$^\circ\text{C}$	
Source Current (Body Diode)	$I_S$	191	A	
Single Pulse Drain-to-Source Avalanche Energy ( $I_{L(pk)} = 38 \text{ A}$ )	$E_{AS}$	907	mJ	
Lead Temperature for Soldering Purposes (1/8" from case for 10 s)	$T_L$	260	$^\circ\text{C}$	

Stresses exceeding those listed in the Maximum Ratings table may damage the device. If any of these limits are exceeded, device functionality should not be assumed, damage may occur and reliability may be affected.

### THERMAL RESISTANCE MAXIMUM RATINGS

Parameter	Symbol	Value	Unit
Junction-to-Case – Steady State	$R_{\theta JC}$	0.75	$^\circ\text{C}/\text{W}$
Junction-to-Ambient – Steady State (Note 2)	$R_{\theta JA}$	39	

1. The entire application environment impacts the thermal resistance values shown, they are not constants and are only valid for the particular conditions noted.
2. Surface-mounted on FR4 board using a 650 mm<sup>2</sup>, 2 oz. Cu pad.
3. Maximum current for pulses as long as 1 second is higher but is dependent on pulse duration and duty cycle.



ON Semiconductor®

<http://onsemi.com>

$V_{(BR)DSS}$	$R_{DS(ON)} \text{ MAX}$	$I_D \text{ MAX}$
40 V	0.75 mΩ @ 10 V	352 A
	1.0 mΩ @ 4.5 V	

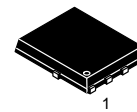
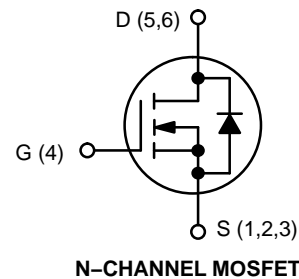

DFN5 (SO-8FL) CASE 488AA STYLE 1

### MARKING DIAGRAM

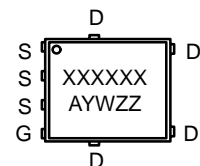

XXXXXX = 5C404L (NVMFS5C404NL) or 404LWF (NVMFS5C404NLWF)

A = Assembly Location  
 Y = Year  
 W = Work Week  
 ZZ = Lot Traceability

### ORDERING INFORMATION

See detailed ordering, marking and shipping information in the package dimensions section on page 5 of this data sheet.

# NVMFS5C404NL

## ELECTRICAL CHARACTERISTICS ( $T_J = 25^\circ\text{C}$ unless otherwise specified)

Parameter	Symbol	Test Condition	Min	Typ	Max	Unit
-----------	--------	----------------	-----	-----	-----	------

### OFF CHARACTERISTICS

Drain-to-Source Breakdown Voltage	$V_{(BR)DSS}$	$V_{GS} = 0\text{ V}, I_D = 250\ \mu\text{A}$	40			V
Drain-to-Source Breakdown Voltage Temperature Coefficient	$V_{(BR)DSS}/T_J$			21.6		mV/°C
Zero Gate Voltage Drain Current	$I_{DSS}$	$V_{GS} = 0\text{ V}, V_{DS} = 40\text{ V}$	$T_J = 25\ ^\circ\text{C}$		1.0	$\mu\text{A}$
			$T_J = 125^\circ\text{C}$		250	
Gate-to-Source Leakage Current	$I_{GSS}$	$V_{DS} = 0\text{ V}, V_{GS} = 16\text{ V}$			100	nA

### ON CHARACTERISTICS (Note 4)

Gate Threshold Voltage	$V_{GS(TH)}$	$V_{GS} = V_{DS}, I_D = 250\ \mu\text{A}$	1.2		2.0	V
Threshold Temperature Coefficient	$V_{GS(TH)}/T_J$			-6.2		mV/°C
Drain-to-Source On Resistance	$R_{DS(on)}$	$V_{GS} = 10\text{ V}$	$I_D = 50\text{ A}$	0.56	0.75	m $\Omega$
		$V_{GS} = 4.5\text{ V}$	$I_D = 50\text{ A}$	0.85	1.0	
Forward Transconductance	$g_{FS}$	$V_{DS} = 15\text{ V}, I_D = 50\text{ A}$		270		S

### CHARGES, CAPACITANCES & GATE RESISTANCE

Input Capacitance	$C_{ISS}$	$V_{GS} = 0\text{ V}, f = 1\text{ MHz}, V_{DS} = 25\text{ V}$		12168		pF
Output Capacitance	$C_{OSS}$			4538		
Reverse Transfer Capacitance	$C_{RSS}$			79.8		
Total Gate Charge	$Q_{G(TOT)}$	$V_{GS} = 4.5\text{ V}, V_{DS} = 20\text{ V}; I_D = 50\text{ A}$		81		nC
Total Gate Charge	$Q_{G(TOT)}$	$V_{GS} = 10\text{ V}, V_{DS} = 20\text{ V}; I_D = 50\text{ A}$		181		
Threshold Gate Charge	$Q_{G(TH)}$	$V_{GS} = 4.5\text{ V}, V_{DS} = 20\text{ V}; I_D = 50\text{ A}$		8.5		
Gate-to-Source Charge	$Q_{GS}$			27.8		
Gate-to-Drain Charge	$Q_{GD}$			23.8		
Plateau Voltage	$V_{GP}$			2.7		V

### SWITCHING CHARACTERISTICS (Note 5)

Turn-On Delay Time	$t_{d(ON)}$	$V_{GS} = 4.5\text{ V}, V_{DS} = 20\text{ V}, I_D = 50\text{ A}, R_G = 1.0\ \Omega$		24		ns
Rise Time	$t_r$			135		
Turn-Off Delay Time	$t_{d(OFF)}$			87		
Fall Time	$t_f$			157		

### DRAIN-SOURCE DIODE CHARACTERISTICS

Forward Diode Voltage	$V_{SD}$	$V_{GS} = 0\text{ V}, I_S = 50\text{ A}$	$T_J = 25^\circ\text{C}$		0.7	1.2	V
			$T_J = 125^\circ\text{C}$		0.61		
Reverse Recovery Time	$t_{RR}$	$V_{GS} = 0\text{ V}, dI_S/dt = 100\text{ A}/\mu\text{s}, I_S = 50\text{ A}$		97.4		ns	
Charge Time	$t_a$			46.5			
Discharge Time	$t_b$			50.9			
Reverse Recovery Charge	$Q_{RR}$			190			nC

Product parametric performance is indicated in the Electrical Characteristics for the listed test conditions, unless otherwise noted. Product performance may not be indicated by the Electrical Characteristics if operated under different conditions.

4. Pulse Test: pulse width  $\leq 300\ \mu\text{s}$ , duty cycle  $\leq 2\%$ .

5. Switching characteristics are independent of operating junction temperatures.

# NVMFS5C404NL

## TYPICAL CHARACTERISTICS

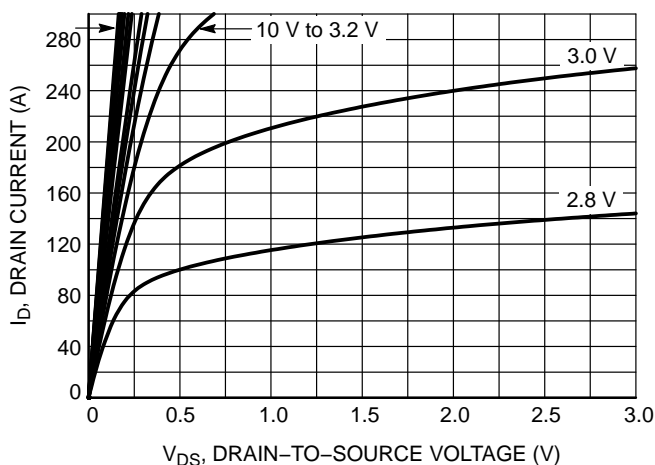

Figure 1. On-Region Characteristics

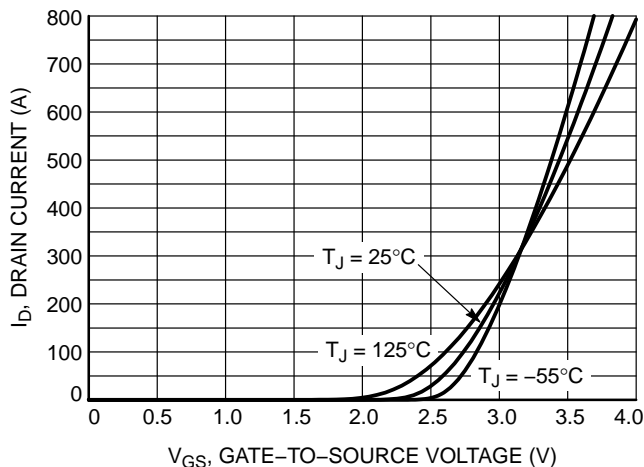

Figure 2. Transfer Characteristics

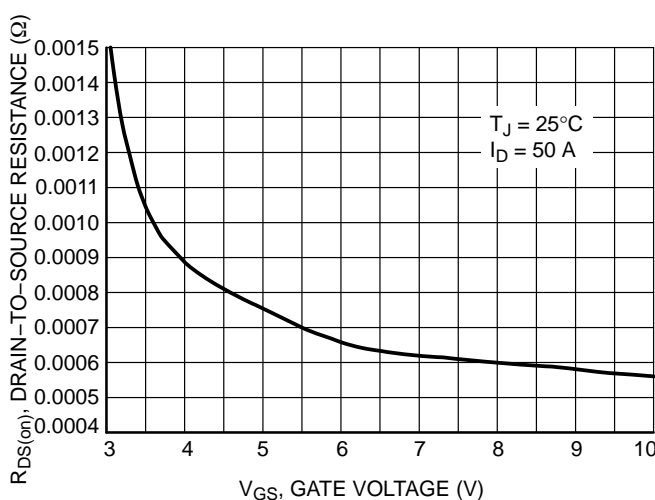

Figure 3. On-Resistance vs. Gate-to-Source Voltage

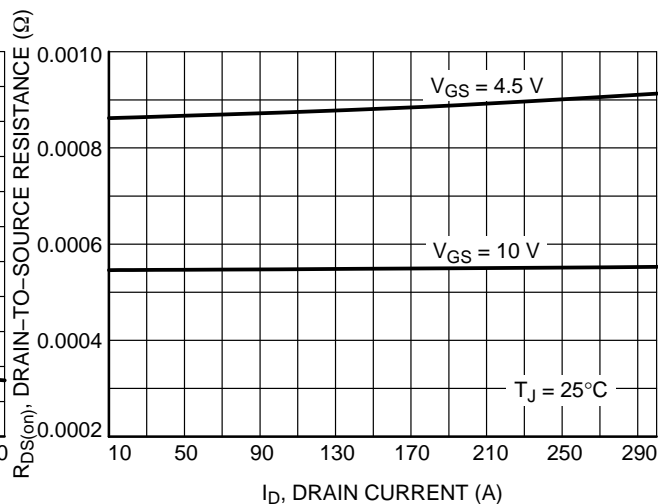

Figure 4. On-Resistance vs. Drain Current and Gate Voltage

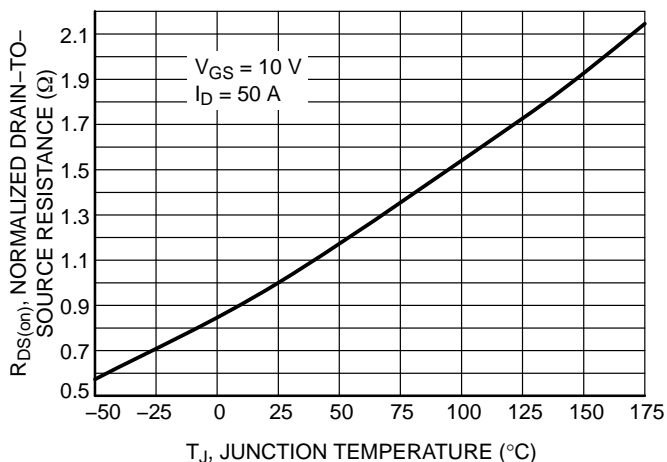

Figure 5. On-Resistance Variation with Temperature

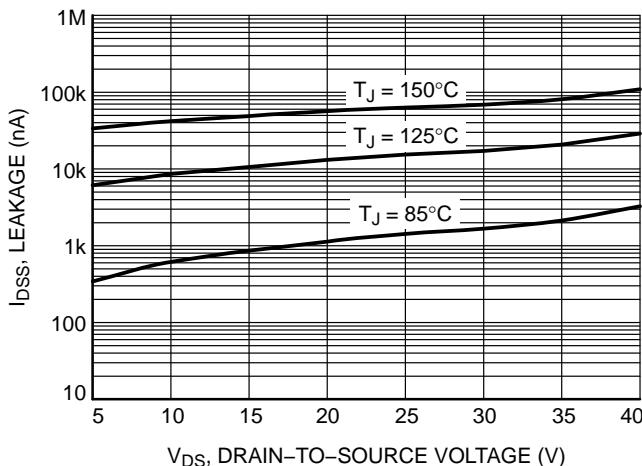

Figure 6. Drain-to-Source Leakage Current vs. Voltage

# NVMFS5C40NL

## TYPICAL CHARACTERISTICS

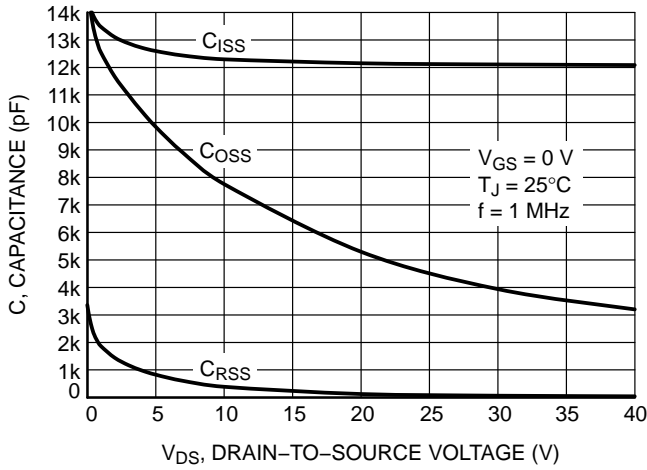

Figure 7. Capacitance Variation

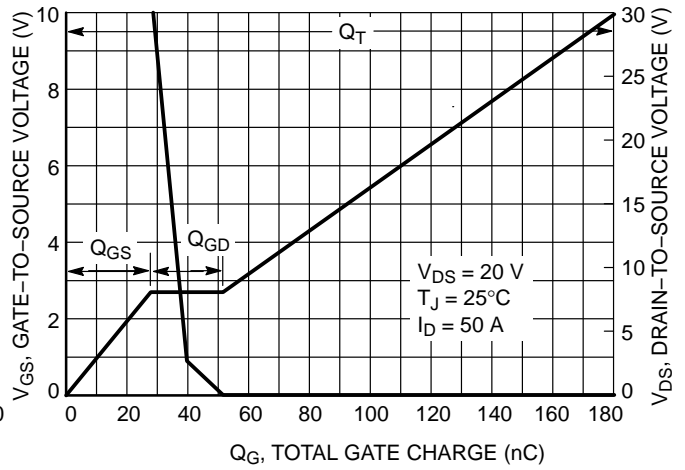

Figure 8. Gate-to-Source and Drain-to-Source Voltage vs. Total Charge

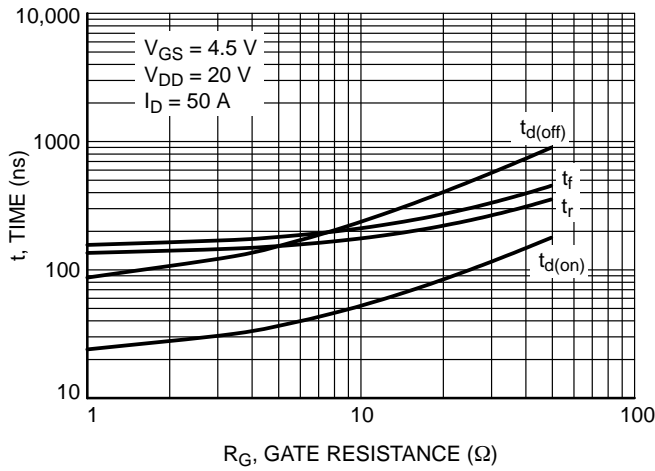

Figure 9. Resistive Switching Time Variation vs. Gate Resistance

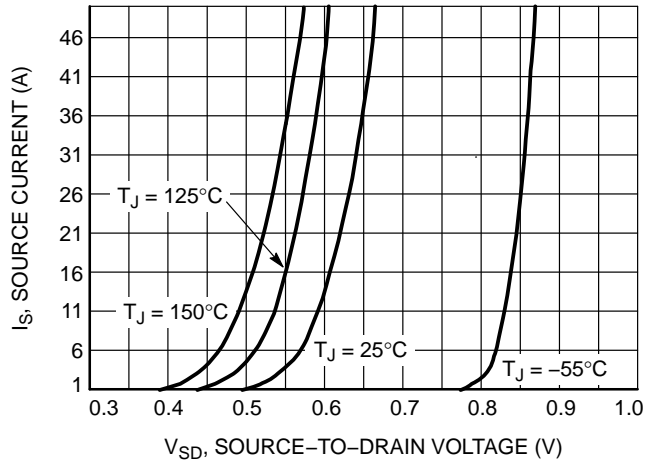

Figure 10. Diode Forward Voltage vs. Current

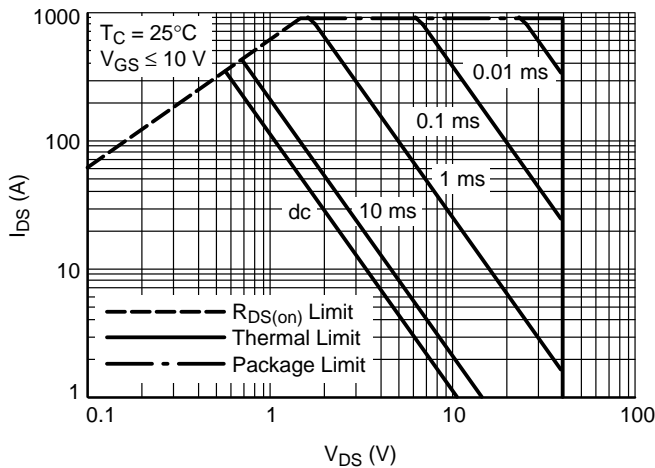

Figure 11. Safe Operating Area

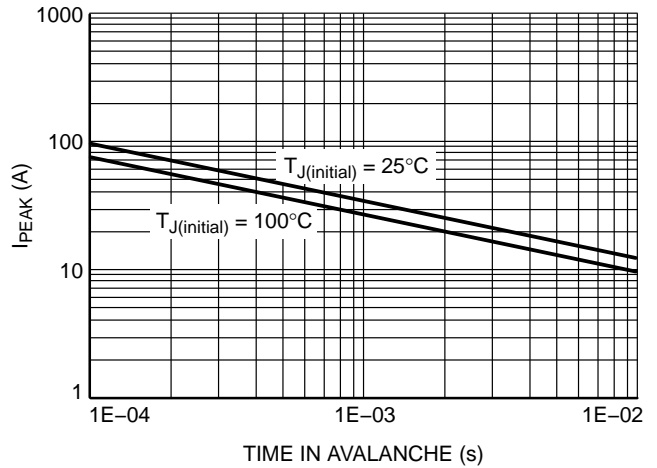

Figure 12.  $I_{PEAK}$  vs. Time in Avalanche

# NVMFS5C404NL

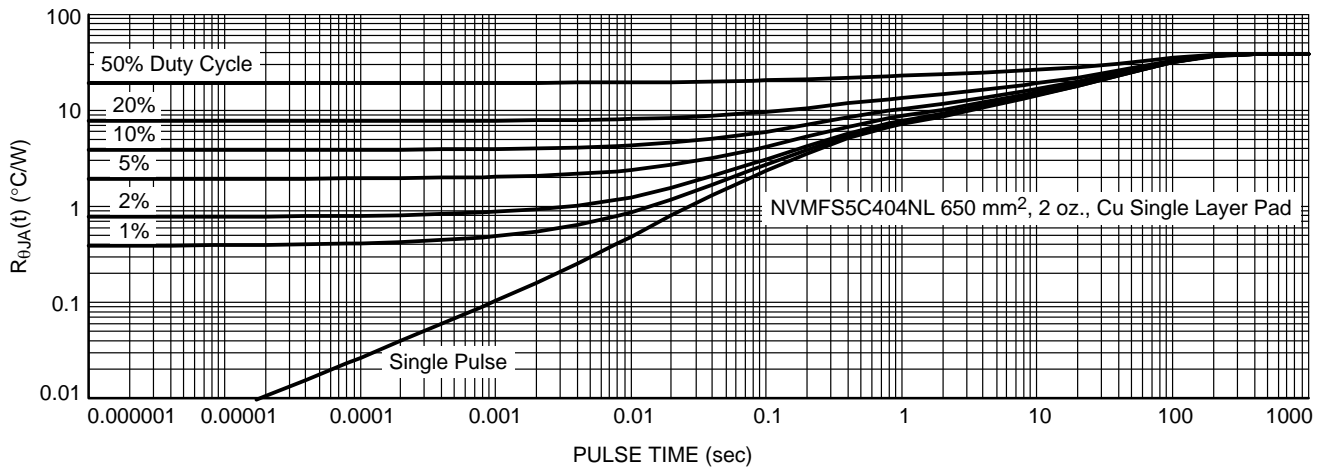

Figure 13. Thermal Characteristics

## DEVICE ORDERING INFORMATION

Device	Marking	Package	Shipping†
NVMFS5C404NLT1G	5C404L	DFN5 (Pb-Free)	1500 / Tape & Reel
NVMFS5C404NLWFT1G	404LWF	DFN5 (Pb-Free, Wettable Flanks)	1500 / Tape & Reel
NVMFS5C404NLT3G	5C404L	DFN5 (Pb-Free)	5000 / Tape & Reel
NVMFS5C404NLWFT3G	404LWF	DFN5 (Pb-Free, Wettable Flanks)	5000 / Tape & Reel

†For information on tape and reel specifications, including part orientation and tape sizes, please refer to our Tape and Reel Packaging Specifications Brochure, BRD8011/D.

# NVMFS5C404NL

## PACKAGE DIMENSIONS

DFN5 5x6, 1.27P  
(SO-8FL)  
CASE 488AA  
ISSUE K

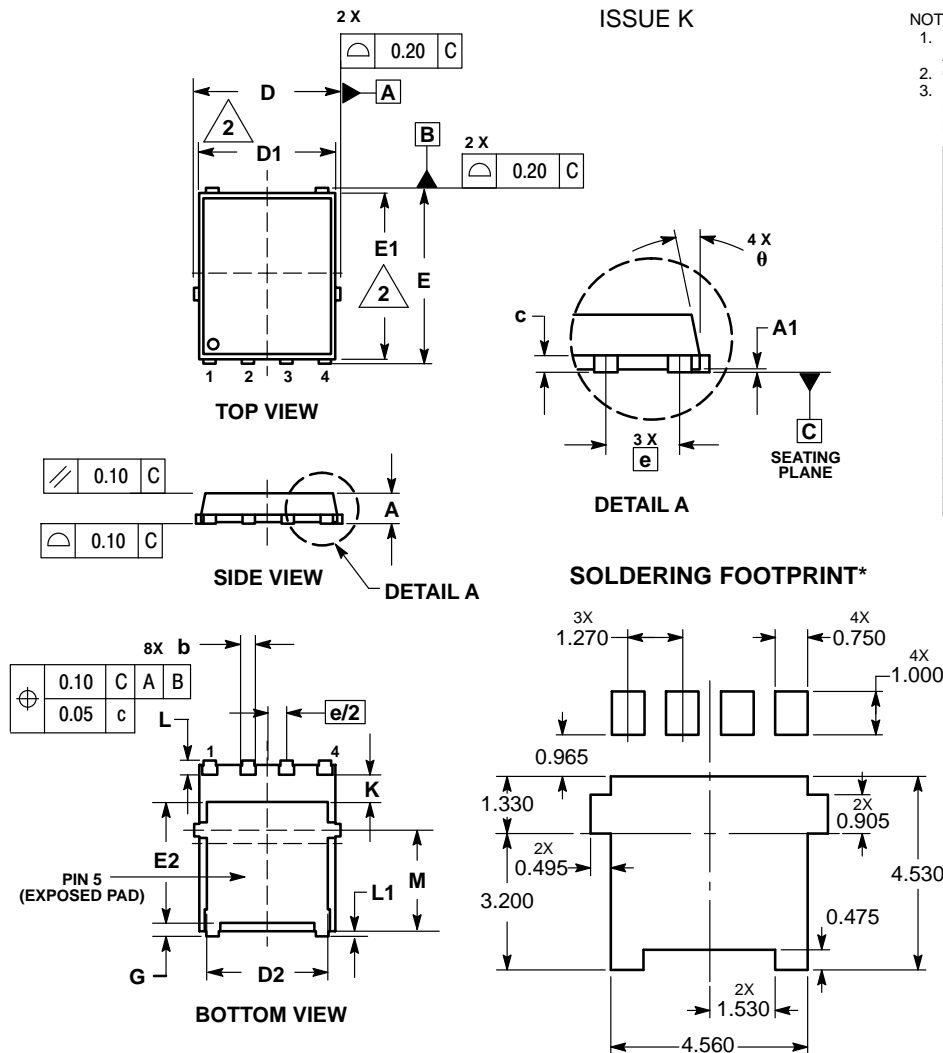

- NOTES:
1. DIMENSIONING AND TOLERANCING PER ASME Y14.5M, 1994.
  2. CONTROLLING DIMENSION: MILLIMETER.
  3. DIMENSION D1 AND E1 DO NOT INCLUDE MOLD FLASH PROTRUSIONS OR GATE BURRS.

DIM	MILLIMETERS		
	MIN	NOM	MAX
A	0.90	1.00	1.10
A1	0.00	---	0.05
b	0.33	0.41	0.51
c	0.23	0.28	0.33
D	5.00	5.15	5.30
D1	4.70	4.90	5.10
D2	3.80	4.00	4.20
E	6.00	6.15	6.30
E1	5.70	5.90	6.10
E2	3.45	3.65	3.85
e	1.27 BSC		
G	0.51	0.61	0.71
K	1.20	1.35	1.50
L	0.51	0.61	0.71
L1	0.125 REF		
M	3.00	3.40	3.80
θ	0°	---	12°

- STYLE 1:
1. SOURCE
  2. SOURCE
  3. SOURCE
  4. GATE
  5. DRAIN

\*For additional information on our Pb-Free strategy and soldering details, please download the ON Semiconductor Soldering and Mounting Techniques Reference Manual, SOLDERRM/D.

ON Semiconductor and are registered trademarks of Semiconductor Components Industries, LLC (SCILLC). SCILLC owns the rights to a number of patents, trademarks, copyrights, trade secrets, and other intellectual property. A listing of SCILLC's product/patent coverage may be accessed at [www.onsemi.com/site/pdf/Patent-Marking.pdf](http://www.onsemi.com/site/pdf/Patent-Marking.pdf). SCILLC reserves the right to make changes without further notice to any products herein. SCILLC makes no warranty, representation or guarantee regarding the suitability of its products for any particular purpose, nor does SCILLC assume any liability arising out of the application or use of any product or circuit, and specifically disclaims any and all liability, including without limitation special, consequential or incidental damages. "Typical" parameters which may be provided in SCILLC data sheets and/or specifications can and do vary in different applications and actual performance may vary over time. All operating parameters, including "Typicals" must be validated for each customer application by customer's technical experts. SCILLC does not convey any license under its patent rights nor the rights of others. SCILLC products are not designed, intended, or authorized for use as components in systems intended for surgical implant into the body, or other applications intended to support or sustain life, or for any other application in which the failure of the SCILLC product could create a situation where personal injury or death may occur. Should Buyer purchase or use SCILLC products for any such unintended or unauthorized application, Buyer shall indemnify and hold SCILLC and its officers, employees, subsidiaries, affiliates, and distributors harmless against all claims, costs, damages, and expenses, and reasonable attorney fees arising out of, directly or indirectly, any claim of personal injury or death associated with such unintended or unauthorized use, even if such claim alleges that SCILLC was negligent regarding the design or manufacture of the part. SCILLC is an Equal Opportunity/Affirmative Action Employer. This literature is subject to all applicable copyright laws and is not for resale in any manner.

### PUBLICATION ORDERING INFORMATION

**LITERATURE FULFILLMENT:**  
Literature Distribution Center for ON Semiconductor  
P.O. Box 5163, Denver, Colorado 80217 USA  
Phone: 303-675-2175 or 800-344-3860 Toll Free USA/Canada  
Fax: 303-675-2176 or 800-344-3867 Toll Free USA/Canada  
Email: [orderlit@onsemi.com](mailto:orderlit@onsemi.com)

**N. American Technical Support:** 800-282-9855 Toll Free  
USA/Canada  
**Europe, Middle East and Africa Technical Support:**  
Phone: 421 33 790 2910  
**Japan Customer Focus Center**  
Phone: 81-3-5817-1050

**ON Semiconductor Website:** [www.onsemi.com](http://www.onsemi.com)  
**Order Literature:** <http://www.onsemi.com/orderlit>  
For additional information, please contact your local Sales Representative

# AMEYA360

Components Supply Platform

Authorized Distribution Brand :



Website :

Welcome to visit [www.ameya360.com](http://www.ameya360.com)

Contact Us :

➤ Address :

401 Building No.5, JiuGe Business Center, Lane 2301, Yishan Rd  
Minhang District, Shanghai , China

➤ Sales :

Direct +86 (21) 6401-6692

Email [amall@ameya360.com](mailto:amall@ameya360.com)

QQ 800077892

Skype [ameyasales1](#) [ameyasales2](#)

➤ Customer Service :

Email [service@ameya360.com](mailto:service@ameya360.com)

➤ Partnership :

Tel +86 (21) 64016692-8333

Email [mkt@ameya360.com](mailto:mkt@ameya360.com)