



ON Semiconductor®

www.onsemi.com

MCH6431

Power MOSFET 30V, 55mΩ, 5A, Single N-Channel

Features

- Low On-Resistance
- 4V Drive
- ESD Diode-Protected Gate
- Pb-Free, Halogen Free and RoHS Compliance

Specifications

Absolute Maximum Ratings at Ta = 25°C

Parameter	Symbol	Value	Unit
Drain to Source Voltage	V _{DSS}	30	V
Gate to Source Voltage	V _{GSS}	±20	V
Drain Current (DC)	I _D	5	A
Drain Current (Pulse) PW≤10μs, duty cycle≤1%	I _{DP}	20	A
Power Dissipation When mounted on ceramic substrate (1200mm ² × 0.8mm)	P _D	1.5	W
Junction Temperature	T _J	150	°C
Storage Temperature	T _{stg}	-55 to +150	°C

Thermal Resistance Ratings

Parameter	Symbol	Value	Unit
Junction to Ambient When mounted on ceramic substrate (1200mm ² × 0.8mm)	R _{θJA}	83.3	°C/W

V _{DSS}	R _{DS(on)} Max	I _D Max
30V	55mΩ@ 10V	5A
	91mΩ@ 4.5V	
	109mΩ@ 4V	

Electrical Connection N-Channel

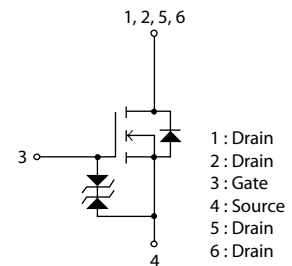

Packing Type : TL

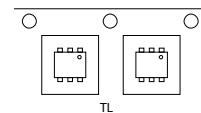

Marking

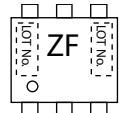

Stresses exceeding those listed in the Maximum Ratings table may damage the device. If any of these limits are exceeded, device functionality should not be assumed, damage may occur and reliability may be affected.

ORDERING INFORMATION

See detailed ordering and shipping information on page 5 of this data sheet.

MCH6431

Electrical Characteristics at $T_a = 25^\circ\text{C}$

Parameter	Symbol	Conditions	Value			Unit
			min	typ	max	
Drain to Source Breakdown Voltage	$V_{(BR)DSS}$	$I_D=1\text{mA}, V_{GS}=0\text{V}$	30			V
Zero-Gate Voltage Drain Current	I_{DSS}	$V_{DS}=30\text{V}, V_{GS}=0\text{V}$			1	μA
Gate to Source Leakage Current	I_{GSS}	$V_{GS}=\pm 16\text{V}, V_{DS}=0\text{V}$			± 10	μA
Gate Threshold Voltage	$V_{GS(th)}$	$V_{DS}=10\text{V}, I_D=1\text{mA}$	1.2		2.6	V
Forward Transconductance	g_{FS}	$V_{DS}=10\text{V}, I_D=2.5\text{A}$		2.2		S
Static Drain to Source On-State Resistance	$R_{DS(on)1}$	$I_D=2.5\text{A}, V_{GS}=10\text{V}$		42	55	$\text{m}\Omega$
	$R_{DS(on)2}$	$I_D=1.2\text{A}, V_{GS}=4.5\text{V}$		65	91	$\text{m}\Omega$
	$R_{DS(on)3}$	$I_D=1.2\text{A}, V_{GS}=4\text{V}$		78	109	$\text{m}\Omega$
Input Capacitance	C_{iss}	$V_{DS}=10\text{V}, f=1\text{MHz}$		280		pF
Output Capacitance	C_{oss}			60		pF
Reverse Transfer Capacitance	C_{rss}			30		pF
Turn-ON Delay Time	$t_{d(on)}$			5.7		ns
Rise Time	t_r	See specified Test Circuit		11		ns
Turn-OFF Delay Time	$t_{d(off)}$			21		ns
Fall Time	t_f			10		ns
Total Gate Charge	Q_g	$V_{DS}=15\text{V}, V_{GS}=10\text{V}, I_D=5\text{A}$		5.6		nC
Gate to Source Charge	Q_{gs}			1.2		nC
Gate to Drain "Miller" Charge	Q_{gd}			0.8		nC
Forward Diode Voltage	V_{SD}		$I_S=5\text{A}, V_{GS}=0\text{V}$		0.85	1.2

Product parametric performance is indicated in the Electrical Characteristics for the listed test conditions, unless otherwise noted. Product performance may not be indicated by the Electrical Characteristics if operated under different conditions.

Switching Time Test Circuit

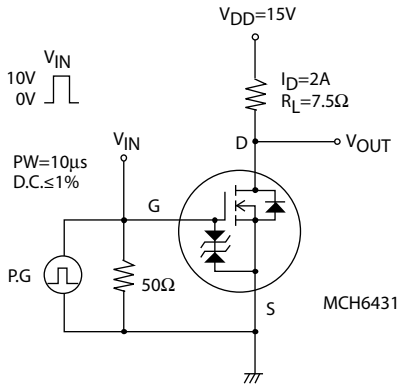

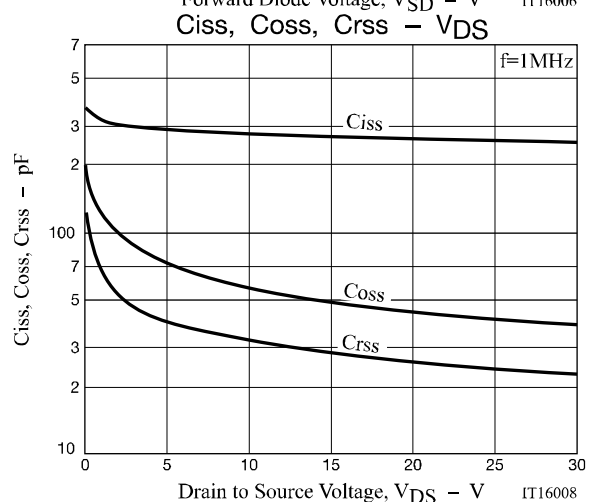
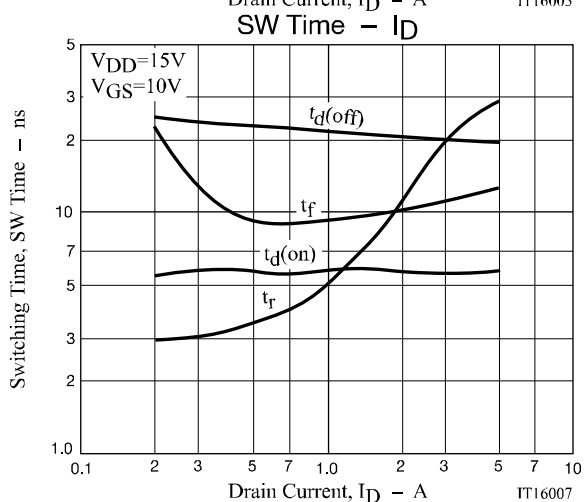
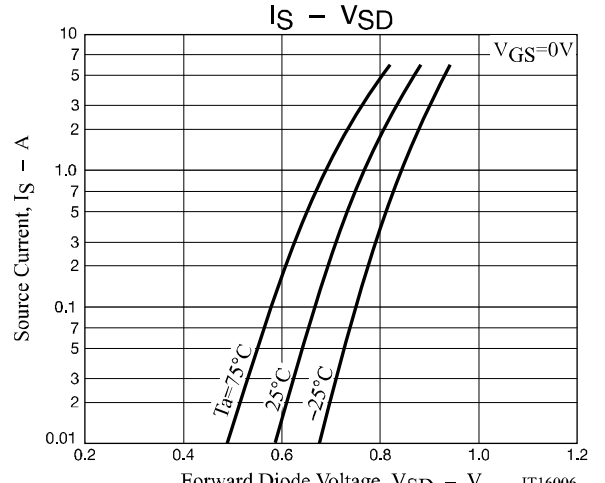
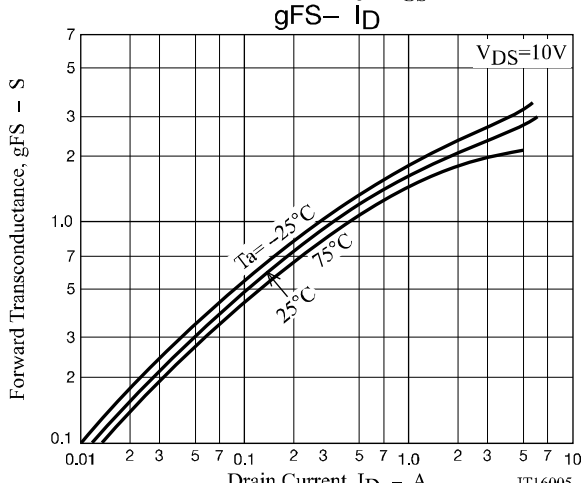
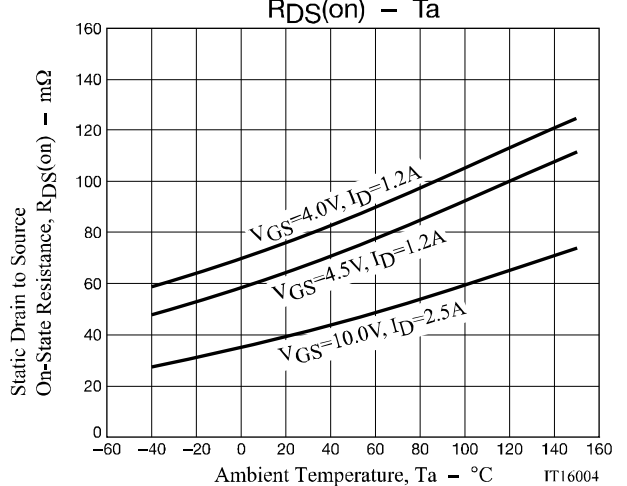
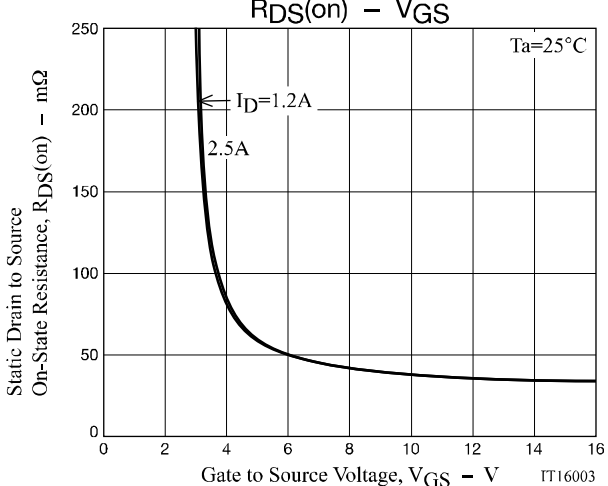
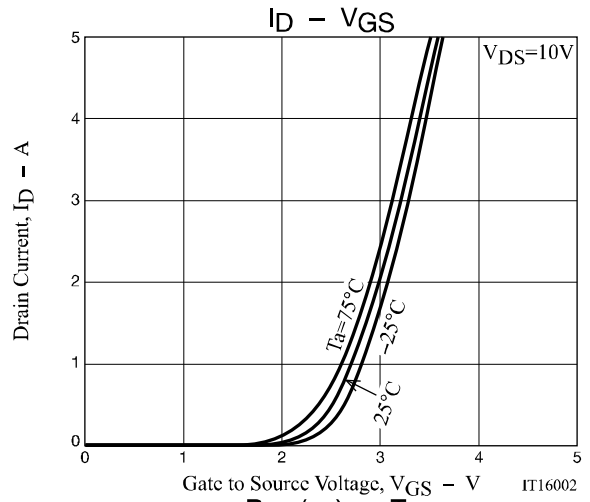
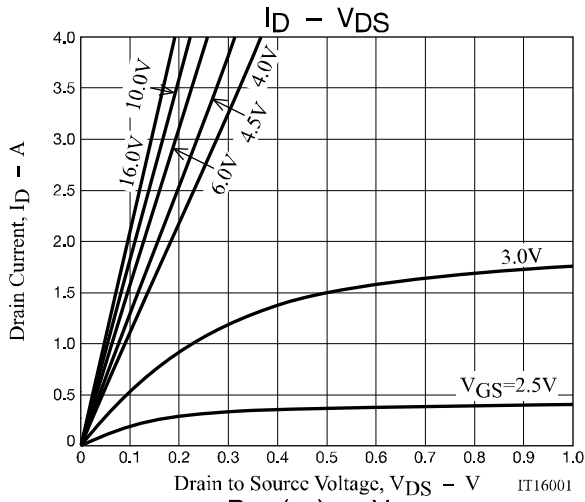

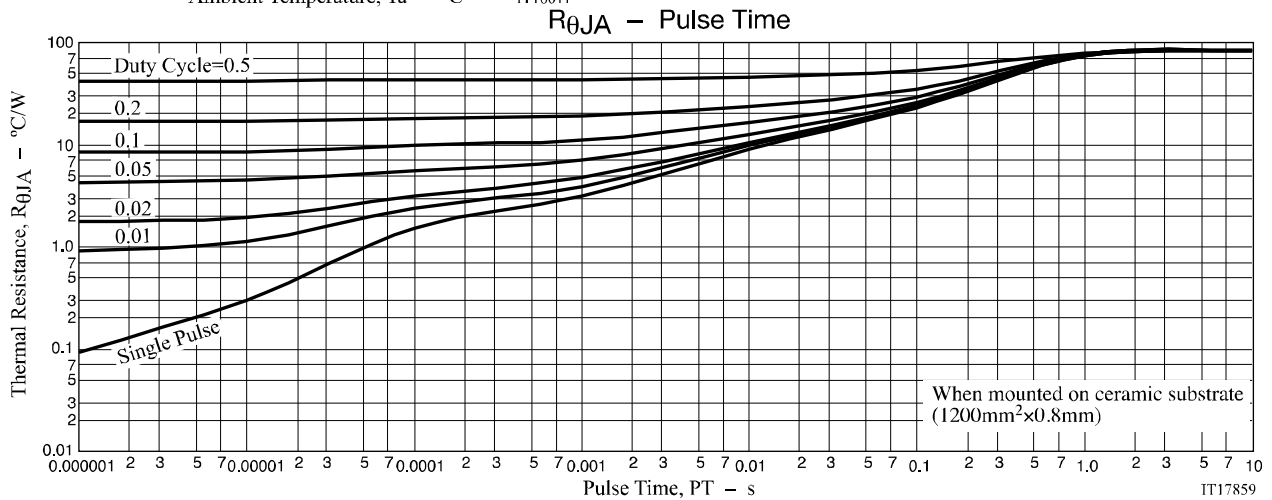
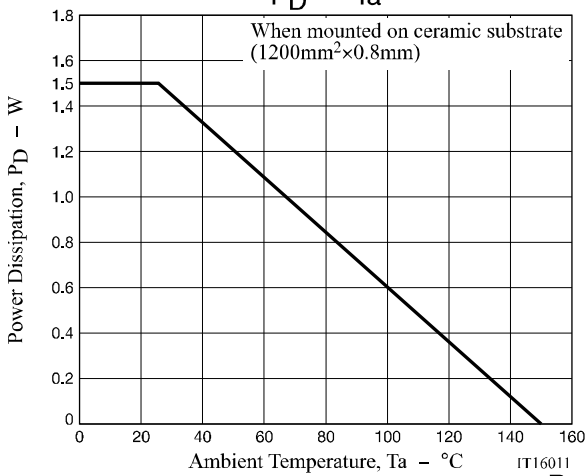
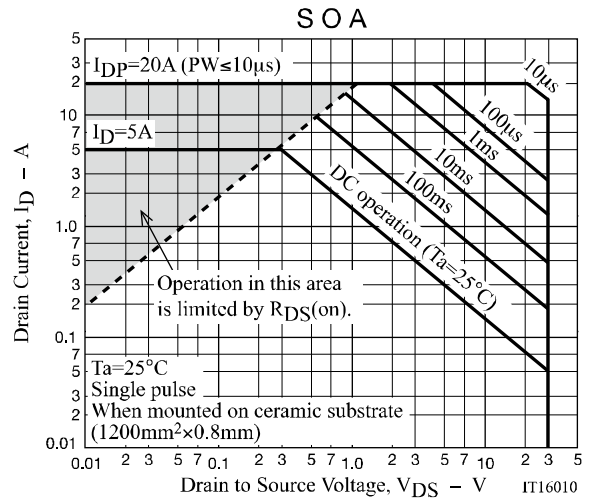
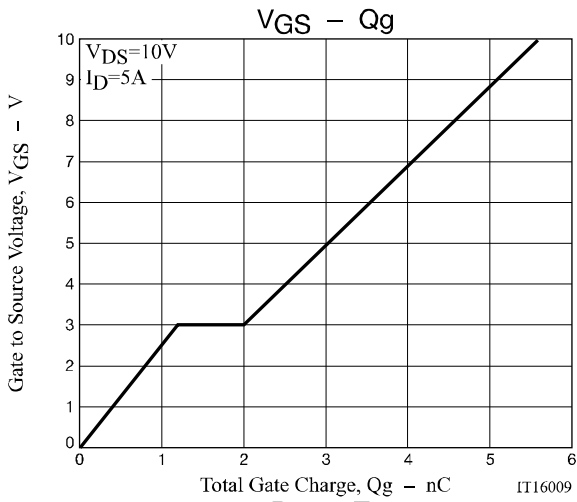

MCH6431

Package Dimensions

MCH6431-TL-H / MCH6431-TL-W

MCPH6

CASE 419AS

ISSUE O

unit : mm

- 1 : Drain
- 2 : Drain
- 3 : Gate
- 4 : Source
- 5 : Drain
- 6 : Drain

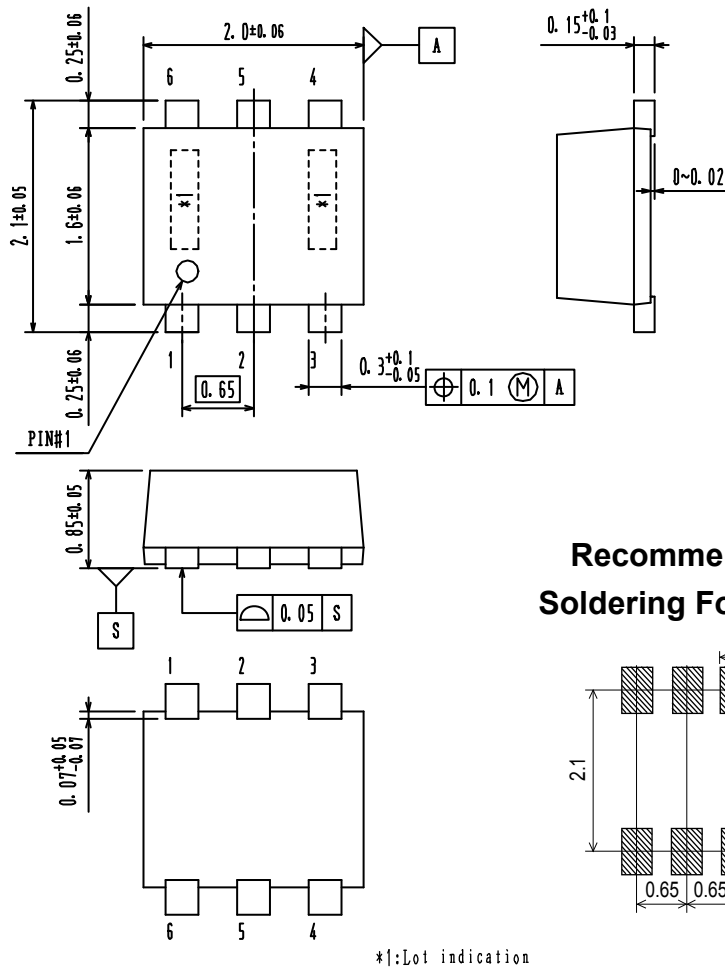

Recommended Soldering Footprint

ORDERING INFORMATION

Device	Package	Shipping	Note
MCH6431-TL-H	MCPH6	3,000 pcs. / Tape & Reel	Pb-Free and Halogen Free
MCH6431-TL-W	SC-88FL, SC-70-6, SOT-363		

† For information on tape and reel specifications, including part orientation and tape sizes, please refer to our Tape and Reel Packaging Specifications Brochure, BRD8011/D. http://www.onsemi.com/pub_link/Collateral/BRD8011-D.PDF

Note on usage : Since the MCH6431 is a MOSFET product, please avoid using this device in the vicinity of highly charged objects.

ON Semiconductor and the ON logo are registered trademarks of Semiconductor Components Industries, LLC (SCILLC) or its subsidiaries in the United States and/or other countries. SCILLC owns the rights to a number of patents, trademarks, copyrights, trade secrets, and other intellectual property. A listing of SCILLC's product/patent coverage may be accessed at www.onsemi.com/site/pdf/Patent-Marking.pdf. SCILLC reserves the right to make changes without further notice to any products herein. SCILLC makes no warranty, representation or guarantee regarding the suitability of its products for any particular purpose, nor does SCILLC assume any liability arising out of the application or use of any product or circuit, and specifically disclaims any and all liability, including without limitation special, consequential or incidental damages. "Typical" parameters which may be provided in SCILLC data sheets and/or specifications can and do vary in different applications and actual performance may vary over time. All operating parameters, including "Typicals" must be validated for each customer application by customer's technical experts. SCILLC does not convey any license under its patent rights nor the rights of others. SCILLC products are not designed, intended, or authorized for use as components in systems intended for surgical implant into the body, or other applications intended to support or sustain life, or for any other application in which the failure of the SCILLC product could create a situation where personal injury or death may occur. Should Buyer purchase or use SCILLC products for any such unintended or unauthorized application, Buyer shall indemnify and hold SCILLC and its officers, employees, subsidiaries, affiliates, and distributors harmless against all claims, costs, damages, and expenses, and reasonable attorney fees arising out of, directly or indirectly, any claim of personal injury or death associated with such unintended or unauthorized use, even if such claim alleges that SCILLC was negligent regarding the design or manufacture of the part. SCILLC is an Equal Opportunity/Affirmative Action Employer. This literature is subject to all applicable copyright laws and is not for resale in any manner.

AMEYA360

Components Supply Platform

Authorized Distribution Brand :



Website :

Welcome to visit www.ameya360.com

Contact Us :

➤ Address :

401 Building No.5, JiuGe Business Center, Lane 2301, Yishan Rd
Minhang District, Shanghai , China

➤ Sales :

Direct +86 (21) 6401-6692

Email amall@ameya360.com

QQ 800077892

Skype [ameyasales1](#) [ameyasales2](#)

➤ Customer Service :

Email service@ameya360.com

➤ Partnership :

Tel +86 (21) 64016692-8333

Email mkt@ameya360.com