

SMD Power Inductor CD54



Halogen Free



Description

- Ferrite drum core construction.
- Magnetically unshielded.
- L × W × H: 6.1 × 5.5 × 4.85mm Max.
- Product weight 0.4g(Ref.)
- Moisture Sensitivity Level: 1
- RoHS compliance.
- Halogen Free available.

Environmental Data

- Operating temperature range: -40°C~+100°C (including coil's self temperature rise)
- Storage temperature range: -40°C~+100°C
- Solder reflow temperature: 260 °C peak.

Packaging

- Carrier tape and reel packaging.
- 13.0" diameter reel
- 1500pcs per reel

Applications

- Ideally used in Mobilephone, PDA, MP3, DSC/DVC, portable DVD etc as DC-DC Converter inductors.

Dimension - [mm]

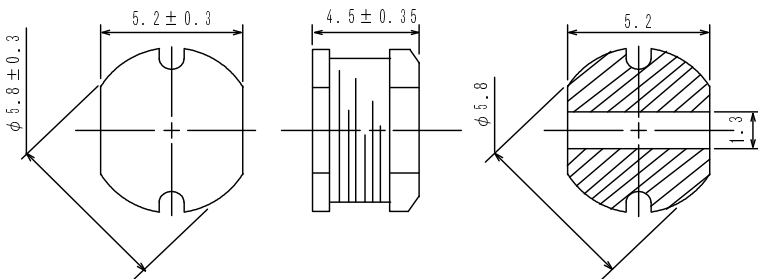

Land pattern and Schematics - [mm]

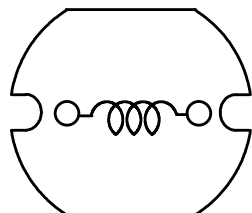
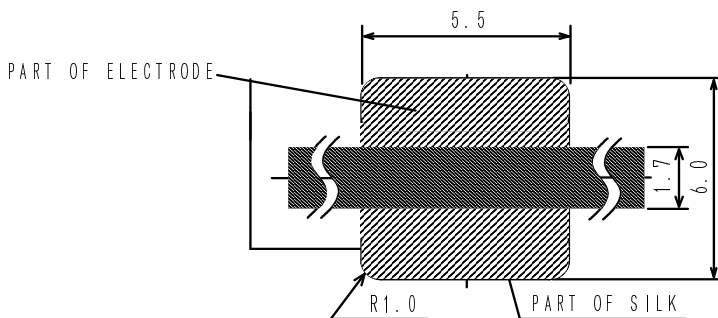

SMD Power Inductor CD54



Electrical Characteristics

Part Name	Stamp	Inductance (μ H) [within] ※1	D.C.R (Ω) [Max.] (at 20°C)	Rated Current (A) ※2
CD54NP-100MC	100	10 \pm 20%	0.10	1.44
CD54NP-120MC	120	12 \pm 20%	0.12	1.40
CD54NP-150MC	150	15 \pm 20%	0.14	1.30
CD54NP-180MC	180	18 \pm 20%	0.15	1.23
CD54NP-220MC	220	22 \pm 20%	0.18	1.11
CD54NP-270MC	270	27 \pm 20%	0.20	0.97
CD54NP-330LC	330	33 \pm 15%	0.23	0.88
CD54NP-390LC	390	39 \pm 15%	0.32	0.80
CD54NP-470LC	470	47 \pm 15%	0.37	0.72
CD54NP-560KC	560	56 \pm 10%	0.42	0.68
CD54NP-680KC	680	68 \pm 10%	0.46	0.61
CD54NP-820KC	820	82 \pm 10%	0.60	0.58
CD54NP-101KC	101	100 \pm 10%	0.70	0.52
CD54NP-121KC	121	120 \pm 10%	0.93	0.48
CD54NP-151KC	151	150 \pm 10%	1.10	0.40
CD54NP-181KC	181	180 \pm 10%	1.38	0.38
CD54NP-221KC	221	220 \pm 10%	1.57	0.35

※1: Inductance measuring frequency: 10 μ H \sim 82 μ H , at 2.52MHz.
100 μ H \sim 220 μ H , at 1 kHz.

※2: Rated current: The DC current at which the inductance decreases to 90 % of it's initial value or when $\Delta t=40^{\circ}\text{C}$, whichever is lower ($T_a=20^{\circ}\text{C}$).

SMD Power Inductor CD54



Saturation Current & Temperature Rise Graph

— L (20°C) — L (105°C) — ΔT

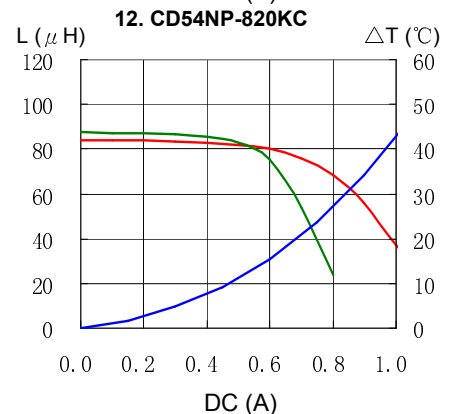
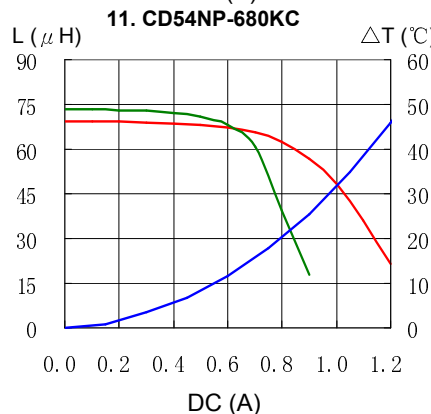
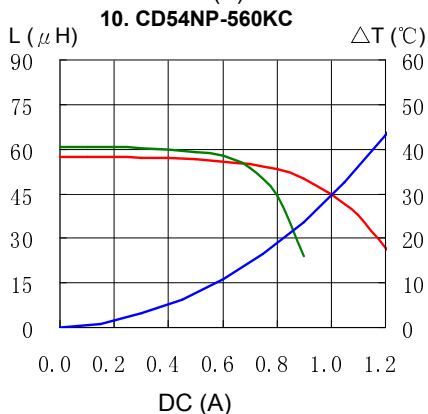
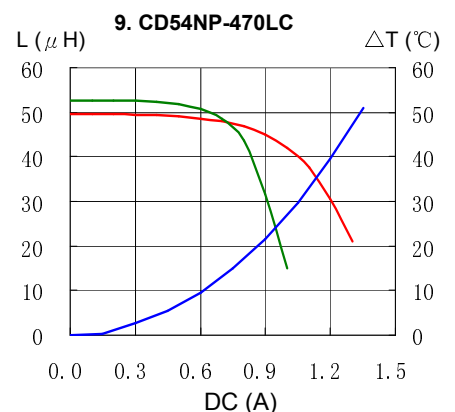
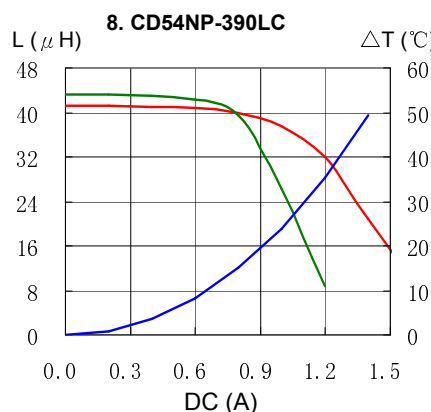
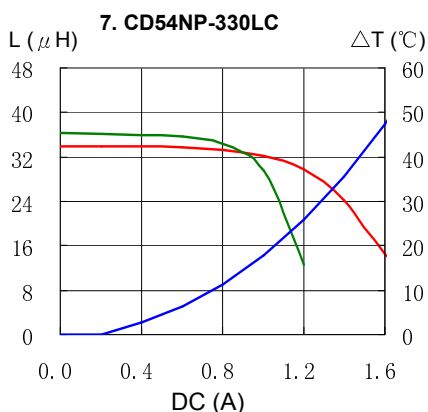
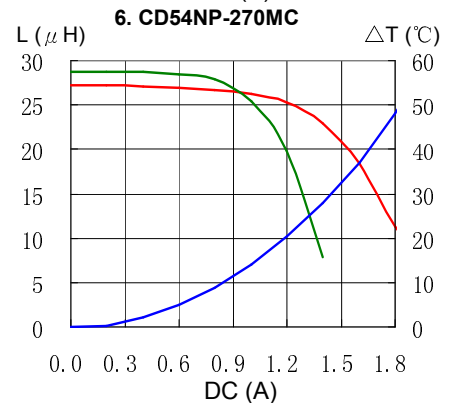
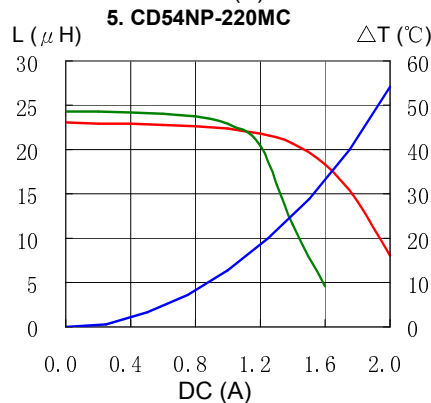
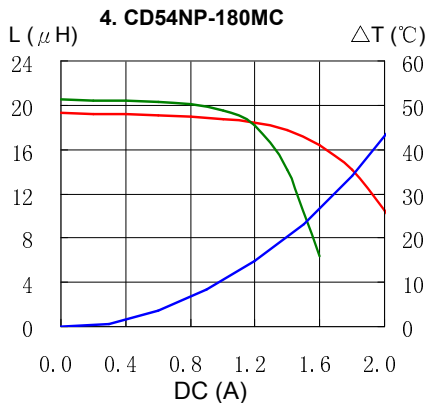
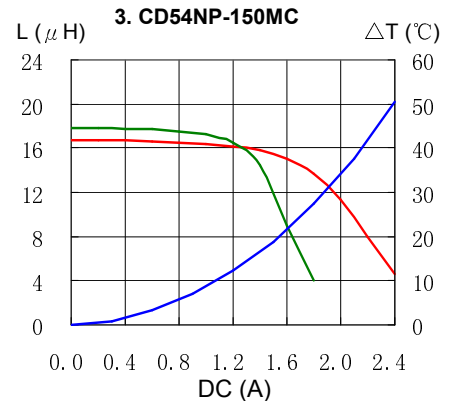
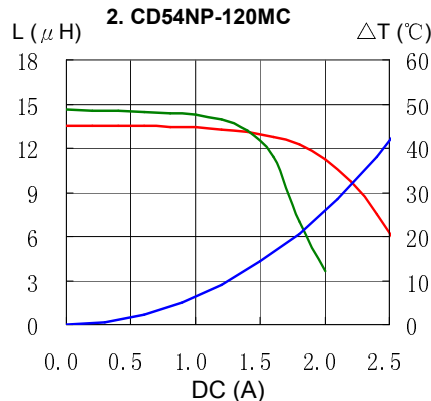
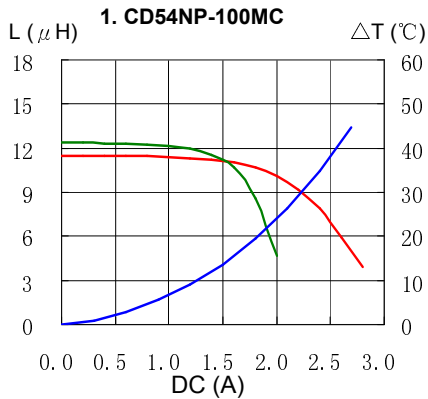

SMD Power Inductor CD54



Saturation Current & Temperature Rise Graph

— L (20°C) — L (105°C) — ΔT

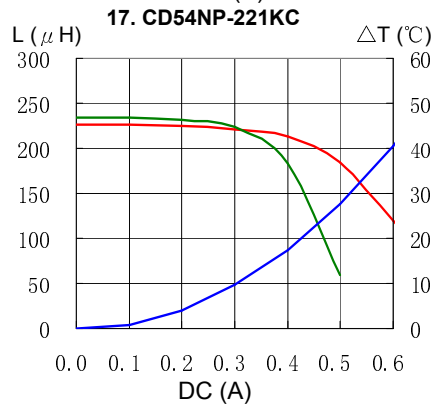
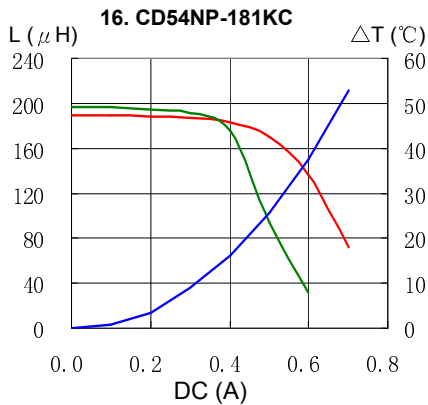
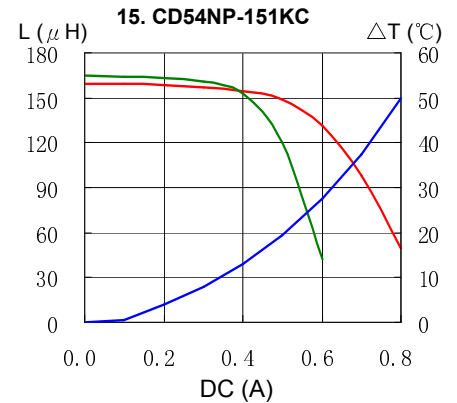
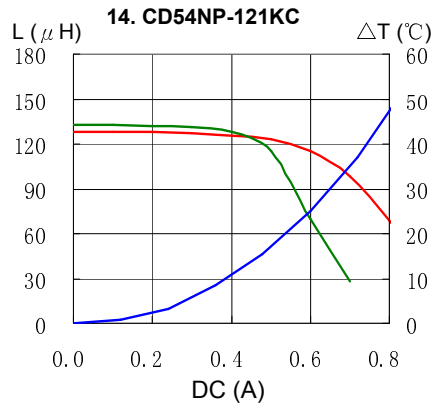
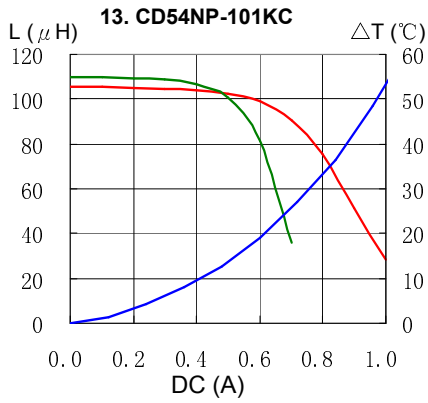

Solder Reflow Condition

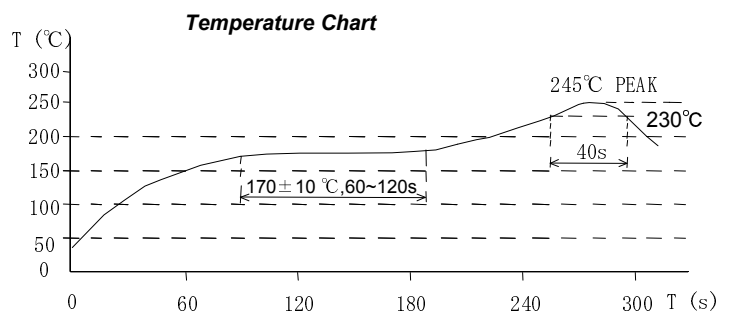
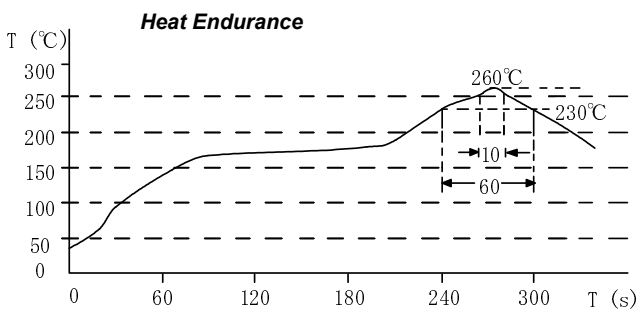

Please refer to the sales offices on our website - <http://www.sumida.com>

Hong Kong
Tel.+852-2880-6781
FAX.+852-2565-9600
sales@hk.sumida.com

Saitama(Japan)
Tel.+81-48-691-7300
FAX.+81-48-691-7340
sales@jp.sumida.com

Chicago
Tel.+1-847-545-6700
FAX. +1-847-545-6720
sales@us.sumida.com

Shanghai
Tel.+86-21-5836-3299
FAX.+86-21-5836-3266
shanghai.sales@cn.sumida.com

Seoul
Tel.+82-2-6237-0777
FAX.+82-2-6237-0778
sales@kr.sumida.com

Oberzell
Tel.+49-8591-937-0
FAX. +49-8591-937-103
contact@eu.sumida.com

Shenzhen
Tel.+86-755-8291-0228
FAX.+86-755-8291-0338
shenzhen.sales@cn.sumida.com

Singapore
Tel.+65-6296-3388
FAX.+65-6841-4426
sales@sg.sumida.com

Neumarkt
Tel.+49-9181-4509-110
FAX. +49-9181-4509-310
infocomp@eu.sumida.com

Taipei
Tel.+886-2-8751-2737
FAX.+886-2-8751-2738
sales@tw.sumida.com

San Jose
Tel.+1-408-321-9660
FAX.+1-408-321-9308
sales@us.sumida.com

AMEYA360

Components Supply Platform

Authorized Distribution Brand :



Website :

Welcome to visit www.ameya360.com

Contact Us :

➤ Address :

401 Building No.5, JiuGe Business Center, Lane 2301, Yishan Rd
Minhang District, Shanghai , China

➤ Sales :

Direct +86 (21) 6401-6692

Email amall@ameya360.com

QQ 800077892

Skype [ameyasales1](#) [ameyasales2](#)

➤ Customer Service :

Email service@ameya360.com

➤ Partnership :

Tel +86 (21) 64016692-8333

Email mkt@ameya360.com