

FSDM0465RE, FSDM0565RE, FSDM07652RE Green Mode Fairchild Power Switch (FPS™)

Features

- Internal Avalanche-Rugged SenseFET
- Advanced Burst-Mode Operation Consumes Under 1W at 240V_{AC} & 0.5W load
- Precision Fixed Operating Frequency (66kHz)
- Internal Start-up Circuit
- Improved Pulse-by-Pulse Current Limiting
- Over-Voltage Protection (OVP)
- Overload Protection (OLP)
- Internal Thermal Shutdown Function (TSD)
- Auto-Restart Mode
- Under-Voltage Lockout (UVLO) with hysteresis
- Low Operating Current (2.5mA)
- Built-in Soft-Start

Applications

- SMPS for LCD monitor and STB
- Adaptor

Description

The FSDM0465RE, FSDM0565RE and FSDM07652RE are an integrated Pulse Width Modulator (PWM) and SenseFET specifically designed for high-performance offline Switch Mode Power Supplies (SMPS) with minimal external components. This device is an integrated high-voltage power-switching regulator that combines an avalanche-rugged SenseFET with a current mode PWM control block. The PWM controller includes an integrated fixed-frequency oscillator, under-voltage lockout, leading-edge blanking (LEB), optimized gate driver, internal soft-start, temperature-compensated precise-current sources for a loop compensation, and self-protection circuitry. Compared with a discrete MOSFET and PWM controller solution, it can reduce total cost; component count, size, and weight; while simultaneously increasing efficiency, productivity, and system reliability. This device is a basic platform well suited for cost-effective designs of flyback converters.

Ordering Information

Product Number	Package	Marking Code	BV _{DSS}	R _{DS(ON)} Max.
FSDM0465REWDTU ⁽¹⁾	TO-220F-6L (Forming)	DM0465RE	650V	2.6 Ω
FSDM0565REWDTU	TO-220F-6L (Forming)	DM0565RE	650V	2.2 Ω
FSDM07652REWDTU	TO-220F-6L (Forming)	DM07652RE	650V	1.6 Ω

Note:

1. WDTU: Forming Type.

 All packages are lead free per JEDEC: J-STD-020B standard.

FPS™ is a trademark of Fairchild Semiconductor Corporation.

Internal Block Diagram

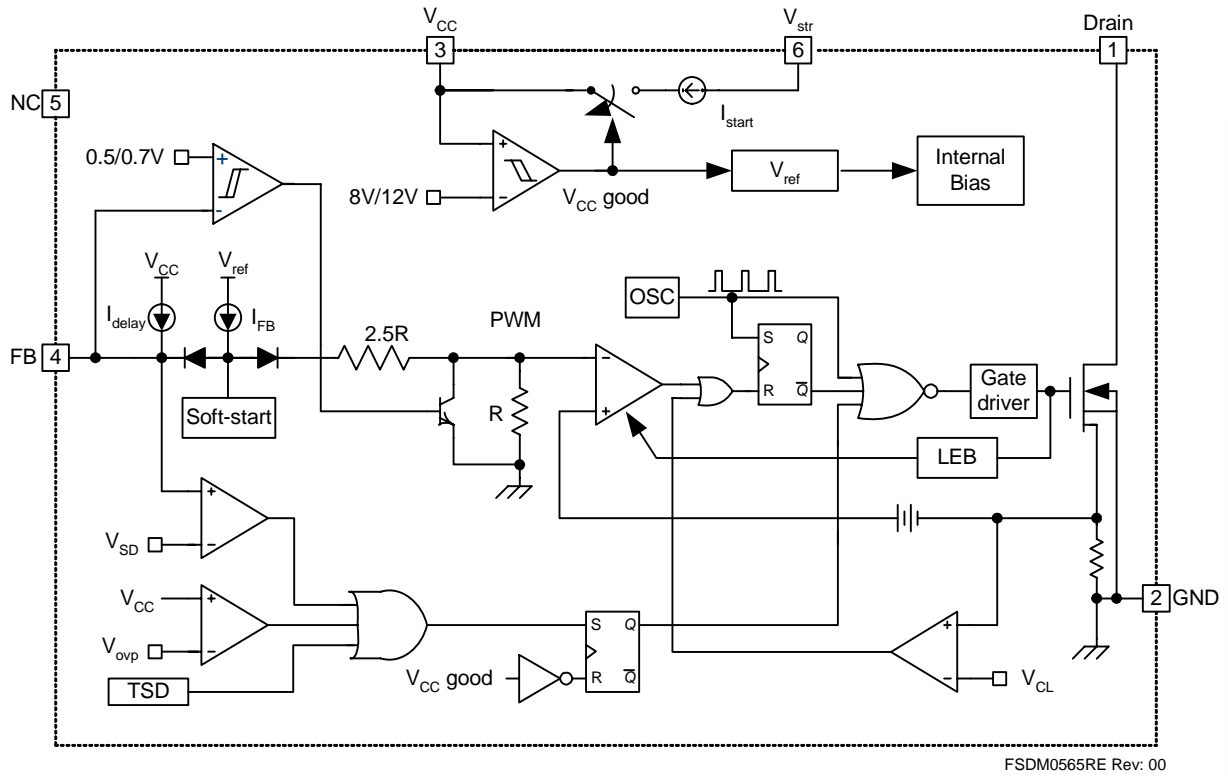

Figure 2. Functional Block Diagram of FSDM0x65RE

Pin Configuration

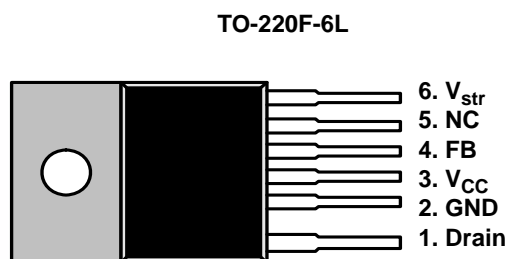

Figure 3. Pin Configuration (Top View)

Pin Definitions

Pin #	Name	Description
1	Drain	SenseFET drain. This pin is the high-voltage power SenseFET drain. It is designed to drive the transformer directly.
2	GND	Ground. This pin is the control ground and the SenseFET source.
3	V_{CC}	Power Supply. This pin is the positive supply voltage input. During start-up, the power is supplied by an internal high-voltage current source connected to the V_{str} pin. When V_{CC} reaches 12V, the internal high-voltage current source is disabled and the power is supplied from the auxiliary transformer winding.
4	FB	Feedback. This pin is internally connected to the inverting input of the PWM comparator. The collector of an opto-coupler is typically tied to this pin. For stable operation, a capacitor should be placed between this pin and GND. If the voltage of this pin reaches 6.0V, the overload protection is activated, resulting in shutdown of the FPS™.
5	NC	No Connection.
6	V_{str}	Start-up. This pin is connected directly to the high-voltage DC link. At start-up, the internal high-voltage current source supplies internal bias and charges the external capacitor connected to the V_{CC} pin. Once V_{CC} reaches 12V, the internal current source is disabled.

Absolute Maximum Ratings

The “Absolute Maximum Ratings” are those values beyond which the safety of the device cannot be guaranteed. The device should not be operated at these limits. The parametric values defined in the Electrical Characteristics tables are not guaranteed at the absolute maximum ratings. $T_A = 25^\circ\text{C}$, unless otherwise specified.

Symbol	Parameter		Value	Unit	
BV_{DSS}	Drain Source Breakdown Voltage		650	V	
V_{str}	Max. Voltage at Vstart pin		650	V	
I_{DM}	Drain Current Pulsed ⁽⁵⁾	FSDM0465RE	$T_C=25^\circ\text{C}$	9.6	A_{DC}
		FSDM0565RE	$T_C=25^\circ\text{C}$	11	
		FSDM07652RE	$T_C=25^\circ\text{C}$	15	
I_D	Continuous Drain Current	FSDM0465RE	$T_C=25^\circ\text{C}$	2.2	A
			$T_C=100^\circ\text{C}$	1.4	
		FSDM0565RE	$T_C=25^\circ\text{C}$	2.8	
			$T_C=100^\circ\text{C}$	1.7	
		FSDM07652RE	$T_C=25^\circ\text{C}$	3.8	
			$T_C=100^\circ\text{C}$	2.4	
E_{AS}	Single Pulsed Avalanche Energy ⁽⁶⁾	FSDM0465RE			mJ
		FSDM0565RE	190		
		FSDM07652RE	370		
V_{CC}	Supply Voltage		20	V	
V_{FB}	Input Voltage Range		-0.3 to V_{CC}	V	
P_D (Watt H/S)	Total Power Dissipation ($T_C=25^\circ\text{C}$)		45	W	
T_J	Operating Junction Temperature		Internally limited	$^\circ\text{C}$	
T_A	Operating Ambient Temperature		-25 to +85	$^\circ\text{C}$	
T_{STG}	Storage Temperature		-55 to +150	$^\circ\text{C}$	
	ESD Capability, HBM Model (All pins except V_{str} and FB)		2.0 ($GND-V_{str}/V_{FB}=1.5\text{kV}$)	kV	
	ESD Capability, Machine Model (All pins except V_{str} and FB)		300 ($GND-V_{str}/V_{FB}=225\text{V}$)	V	

Notes:

- Repetitive rating: Pulse width limited by maximum junction temperature.
- $L=14\text{mH}$, starting $T_J=25^\circ\text{C}$.

Thermal Impedance

$T_A=25^\circ\text{C}$, unless otherwise specified.

Symbol	Parameter	Value	Unit
θ_{JA} ⁽⁷⁾	Junction-to-Ambient Thermal Resistance	49.90	$^\circ\text{C}/\text{W}$
θ_{JC} ⁽⁸⁾	Junction-to-Case Thermal Resistance	2.78	$^\circ\text{C}/\text{W}$

Notes:

- Free-standing, with no heat-sink, under natural convection.
- Infinite cooling condition - refer to the SEMI G30-88.

Electrical Characteristics

T_A = 25°C unless otherwise specified.

Symbol	Parameter	Condition	Min.	Typ.	Max.	Unit	
SenseFET SECTION							
I _{DSS}	Zero Gate Voltage Drain Current	FSDM0465RE	V _{DS} = 650V, V _{GS} = 0V		250	μA	
			V _{DS} = 520V, V _{GS} = 0V, T _C = 125°C		250		
		FSDM0565RE	V _{DS} = 650V, V _{GS} = 0V		500		
			V _{DS} = 520V, V _{GS} = 0V, T _C = 125°C		500		
		FSDM07652RE	V _{DS} = 650V, V _{GS} = 0V		500		
			V _{DS} = 520V, V _{GS} = 0V, T _C = 125°C		500		
R _{DS(ON)}	Static Drain Source on Resistance ⁽⁹⁾	FSDM0465RE	V _{GS} = 10V, I _D = 2.5A	2.20	2.60	Ω	
		FSDM0565RE		1.76	2.20		
		FSDM07652RE		1.40	1.60		
C _{OSS}	Output Capacitance	FSDM0465RE	V _{GS} = 0V, V _{DS} = 25V, f = 1MHz	60		pF	
		FSDM0565RE		78			
		FSDM07652RE		100			
t _{d(on)}	Turn-On Delay Time	FSDM0465RE	V _{DD} = 325V, I _D = 5A	23		ns	
		FSDM0565RE		22			
		FSDM07652RE		22			
t _r	Rise Time	FSDM0465RE	V _{DD} = 325V, I _D = 5A	20		ns	
		FSDM0565RE		52			
		FSDM07652RE		60			
t _{d(off)}	Turn-Off Delay Time	FSDM0465RE	V _{DD} = 325V, I _D = 5A	65		ns	
		FSDM0565RE		95			
		FSDM07652RE		115			
t _f	Fall Time	FSDM0465RE	V _{DD} = 325V, I _D = 5A	27		ns	
		FSDM0565RE		50			
		FSDM07652RE		65			
CONTROL SECTION							
f _{OSC}	Switching Frequency	V _{FB} = 3V	60	66	72	kHz	
Δf _{STABLE}	Switching Frequency Stability	13V ≤ V _{CC} ≤ 18V	0	1	3	%	
Δf _{OSC}	Switching Frequency Variation ⁽¹⁰⁾	-25°C ≤ T _A ≤ 85°C	0	±5	±10	%	
I _{FB}	Feedback Source Current	V _{FB} = GND	0.7	0.9	1.1	mA	
D _{MAX}	Maximum Duty Cycle	FSDM0465RE		77	82	87	%
		FSDM0565RE		77	82	87	%
		FSDM07652RE		75	80	85	%
D _{MIN}	Minimum Duty Cycle				0	%	
V _{START}	UVLO Threshold Voltage	V _{FB} = GND	11	12	13	V	
V _{STOP}		V _{FB} = GND	7	8	9	V	
t _{S/S}	Internal Soft-Start Time	V _{FB} = 3		10	15	ms	

Electrical Characteristics (Continued)

T_A = 25°C unless otherwise specified.

Symbol	Parameter	Condition	Min.	Typ.	Max.	Unit
BURST MODE SECTION						
V _{BURH}	Burst Mode Voltages	V _{CC} = 14V		0.7		V
V _{BURL}		V _{CC} = 14V		0.5		V
PROTECTION SECTION						
V _{SD}	Shutdown Feedback Voltage	V _{FB} ≥ 5.5V	5.5	6.0	6.5	V
I _{DELAY}	Shutdown Delay Current	V _{FB} = 5V	2.8	3.5	4.2	μA
t _{LEB}	Leading-Edge Blanking Time			250		ns
I _{LIMIT}	Peak Current Limit ⁽¹¹⁾	FSDM0465RE V _{FB} = 5V, V _{CC} = 14V	1.60	1.80	2.00	A
		FSDM0565RE V _{FB} = 5V, V _{CC} = 14V	2.00	2.25	2.50	
		FSDM07652RE V _{FB} = 5V, V _{CC} = 14V	2.20	2.50	2.70	
V _{OVP}	Over-Voltage Protection		18	19	20	V
T _{SD}	Thermal Shutdown Temperature ⁽¹⁰⁾		130	145	160	°C
TOTAL DEVICE SECTION						
I _{OP}	Operating Supply Current ⁽¹²⁾	V _{FB} = GND, V _{CC} = 14V		2.5	5.0	mA
I _{OP(MIN)}		V _{FB} = GND, V _{CC} = 10V				
I _{OP(MAX)}		V _{FB} = GND, V _{CC} = 18V				

Notes:

9. Pulse test: Pulse width ≤ 300μS, duty cycle ≤ 2%.
10. These parameters, although guaranteed at the design, are not tested in production.
11. These parameters indicate the inductor current.
12. This parameter is the current flowing into the control IC.

Comparison Between FS6M0765RTC and FSDM0x65RE

Function	FS6M0765RTC	FSDM0x65RE	FSDM0x65RE Advantages
Soft-Start	Adjustable soft-start time using an external capacitor	Internal soft-start with typically 10ms (fixed)	<ul style="list-style-type: none"> ■ Gradually increasing current limit during soft-start reduces peak current and voltage component stresses ■ Eliminates external soft-start components in most applications ■ Reduces or eliminates output overshoot
Burst-Mode Operation	<ul style="list-style-type: none"> ■ Built into controller ■ Output voltage drops to around half 	<ul style="list-style-type: none"> ■ Built into controller ■ Output voltage fixed 	<ul style="list-style-type: none"> ■ Improves light-load efficiency ■ Reduces no-load consumption

Typical Performance Characteristics

These characteristic graphs are normalized at $T_A = 25^\circ\text{C}$.

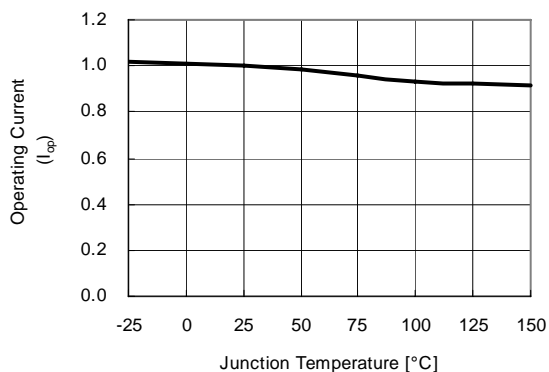

Figure 4. Operating Current vs. Temp.

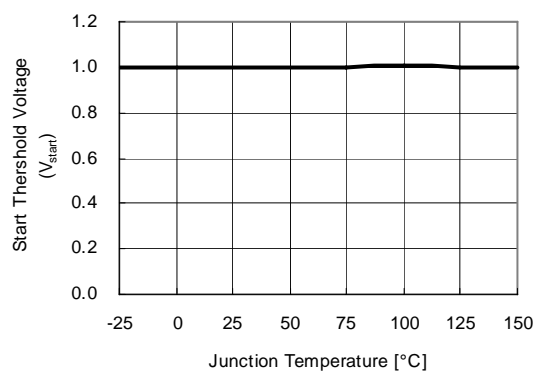

Figure 5. Start Threshold Voltage vs. Temp.

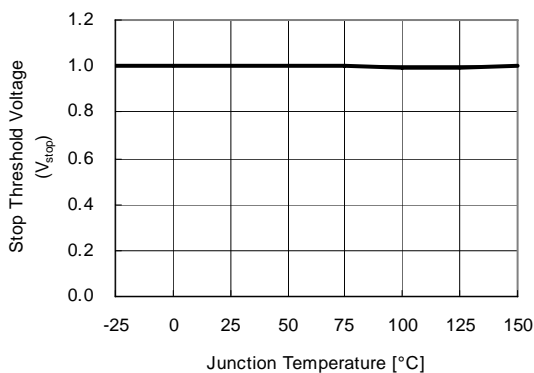

Figure 6. Stop Threshold Voltage vs. Temp.

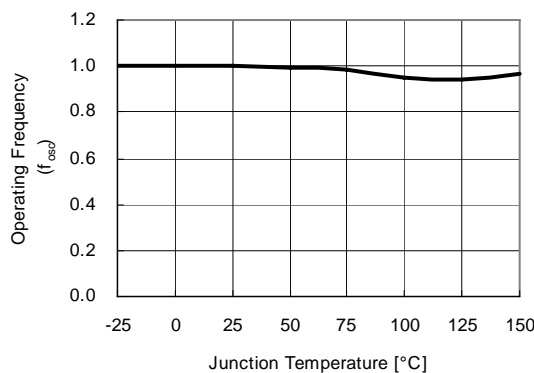

Figure 7. Operating Frequency vs. Temp.

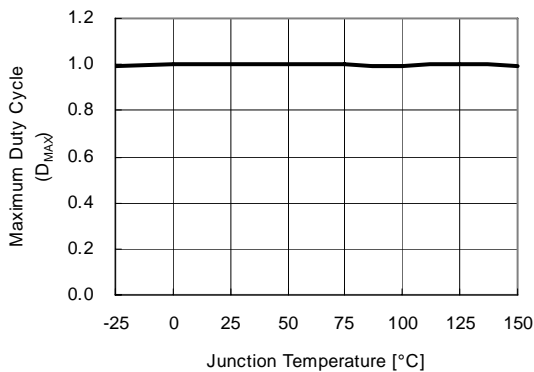

Figure 8. Maximum Duty Cycle vs. Temp.

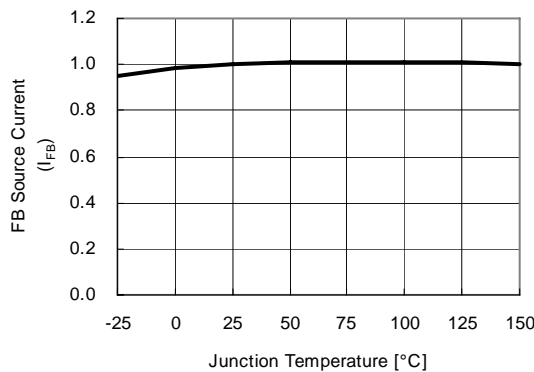

Figure 9. Feedback Source Current vs. Temp.

Typical Performance Characteristics (Continued)

These characteristic graphs are normalized at $T_A = 25^\circ\text{C}$.

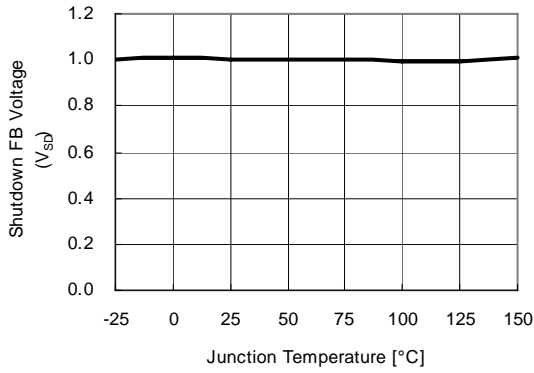

Figure 10. Shutdown Feedback Voltage vs. Temp.

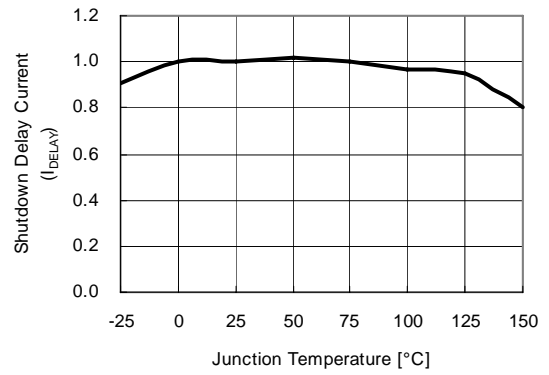

Figure 11. Shutdown Delay Current vs. Temp.

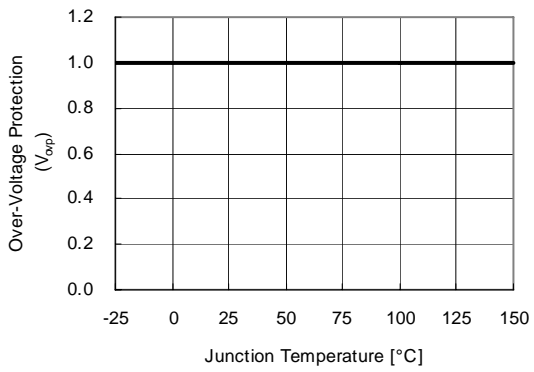

Figure 12. Over-Voltage Protection vs. Temp.

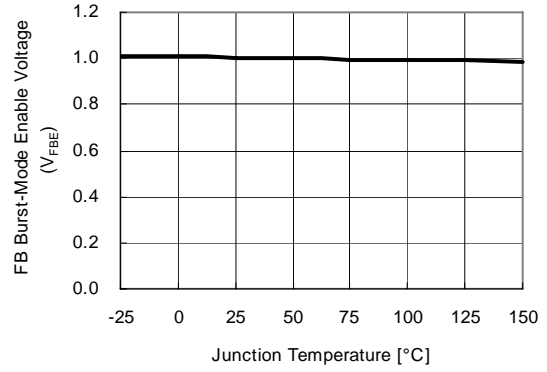

Figure 13. Burst-Mode Enable Voltage vs. Temp.

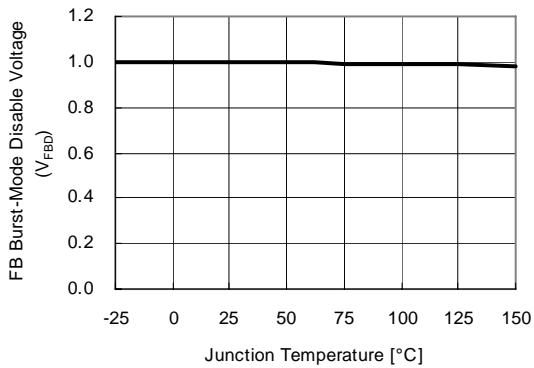

Figure 14. Burst-Mode Disable Voltage vs. Temp.

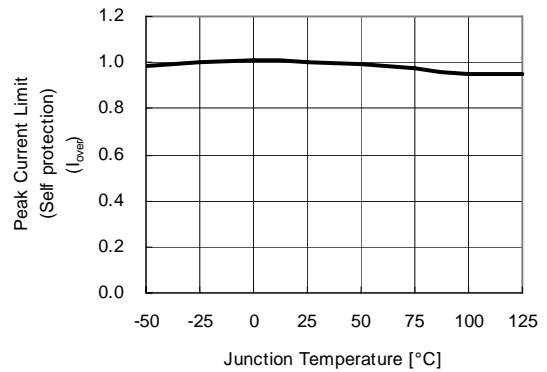

Figure 15. Current Limit vs. Temp.

Typical Performance Characteristics (Continued)

These characteristic graphs are normalized at $T_A = 25^\circ\text{C}$.

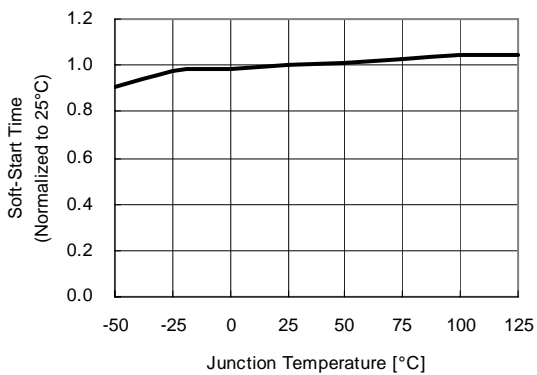

Figure 16. Soft-Start Time vs. Temp.



Functional Description

1. Start-up: In previous generations of Fairchild Power Switches (FPS™), the V_{CC} pin had an external start-up resistor to the DC input voltage line. In this generation, the start-up resistor is replaced by an internal high-voltage current source. At start-up, the internal high-voltage current source supplies the internal bias and charges the external capacitor (C_{VCC}) connected to the V_{CC} pin, as illustrated in Figure 17. When V_{CC} reaches 12V, the FSDM0x65RE begins switching and the internal high-voltage current source is disabled. The FSDM0x65RE continues normal switching operation and the power is supplied from the auxiliary transformer winding unless V_{CC} goes below the stop voltage of 8V.

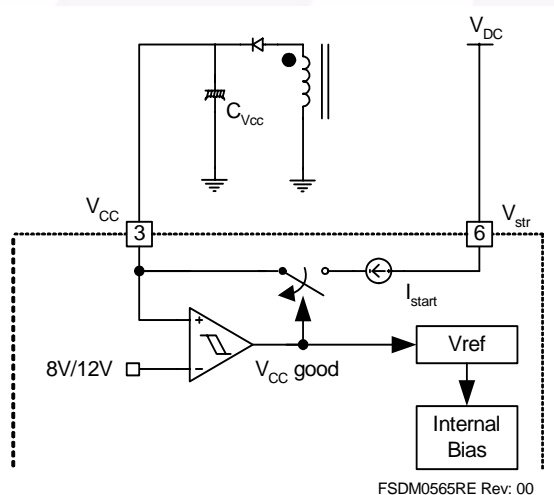

Figure 17. Internal Start-up Circuit

2. Feedback Control: FSDM0x65RE employs current-mode control, as shown in Figure 18. An opto-coupler (such as the H11A817A) and shunt regulator (such as the KA431) are typically used to implement the feedback network. Comparing the feedback voltage with the voltage across the R_{sense} resistor, plus an offset voltage, makes it possible to control the switching duty cycle. When the reference pin voltage of the shunt regulator exceeds the internal reference voltage of 2.5V, the opto-coupler LED current increases, pulling down the feedback voltage and reducing the duty cycle. This event typically occurs when the input voltage is increased or the output load is decreased.

2.1 Pulse-by-Pulse Current Limit: Because current-mode control is employed, the peak current through the SenseFET is limited by the inverting input of PWM comparator (V_{FB}^*) as shown in Figure 18. Assuming that the 0.9mA current source flows only through the internal resistor ($2.5R + R = 2.8k\Omega$), the cathode voltage of diode D2 is about 2.5V. Since D1 is blocked when the feedback voltage (V_{FB}) exceeds 2.5V, the maximum voltage of the cathode of D2 is clamped at this voltage, thus clamping V_{FB}^* . Therefore, the peak value of the current through the SenseFET is limited.

2.2 Leading Edge Blanking (LEB): At the instant the internal SenseFET is turned on, a high-current spike occurs through the SenseFET, caused by primary-side capacitance and secondary-side rectifier reverse recovery. Excessive voltage across the R_{sense} resistor would lead to incorrect feedback operation in the current mode PWM control. To counter this effect, the FSDM0x65RE employs a leading-edge blanking (LEB) circuit. This circuit inhibits the PWM comparator for a short time (t_{LEB}) after the SenseFET is turned on.

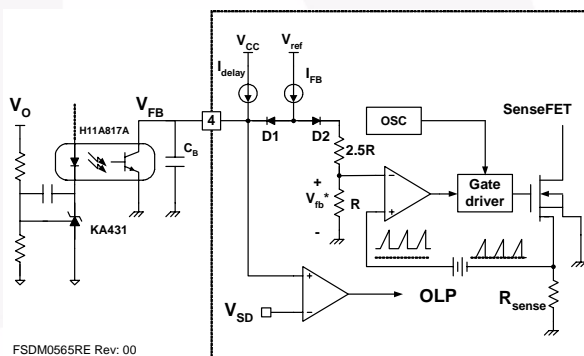

Figure 18. Pulse-Width-Modulation (PWM) Circuit

3. Protection Circuit: The FSDM0x65RE has several self-protective functions, such as overload protection (OLP), over-voltage protection (OVP), and thermal shutdown (TSD). Because these protection circuits are fully integrated into the IC without external components, the reliability is improved without increasing cost. Once a fault condition occurs, switching is terminated and the SenseFET remains off, which causes V_{CC} to fall. When V_{CC} reaches the UVLO stop voltage of 8V, the protection is reset and the internal high-voltage current source charges the V_{CC} capacitor via the V_{str} pin. When V_{CC} reaches the UVLO start voltage of 12V, the FSDM0x65RE resumes normal operation. In this manner, the auto-restart can alternately enable and disable the switching of the power SenseFET until the fault condition is eliminated (see Figure 19).

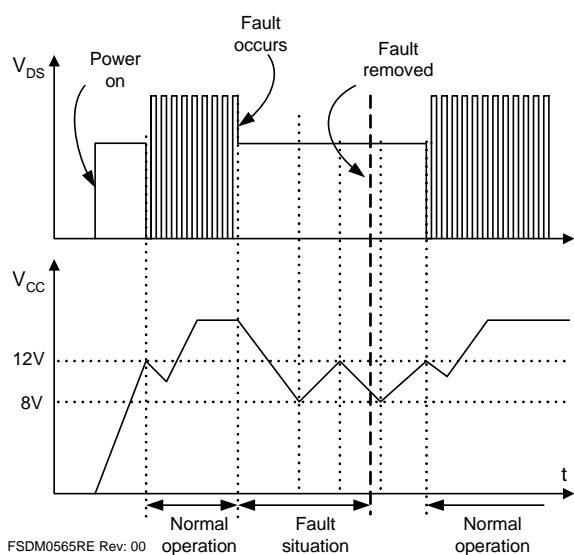

Figure 19. Auto Restart Operation

3.1 Overload Protection (OLP): Overload is defined as the load current exceeding a pre-set level due to an unexpected event. In this situation, the protection circuit should be activated to protect the SMPS. Even when the SMPS is in normal operation, the overload protection circuit can be activated during the load transition. To avoid this undesired operation, the overload protection circuit is designed to be activated after a specified time to determine whether it is a transient situation or a true overload situation. Because of the pulse-by-pulse current limit capability, the maximum peak current through the SenseFET is limited, and therefore the maximum input power is restricted with a given input voltage. If the output consumes beyond this maximum power, the output voltage (V_O) decreases below the set voltage. This reduces the current through the opto-coupler LED, which also reduces the opto-coupler transistor current, thus increasing the feedback voltage (V_{FB}). If V_{FB} exceeds 2.5V, D1 is blocked and the 3.5 μ A current source starts to charge C_B slowly up to V_{CC} . In this condition, V_{FB} continues increasing until it reaches 6V, when the switching operation is terminated, as shown in Figure 20. The delay time for shutdown is the time required to charge C_B from 2.5V to 6.0V with 3.5 μ A. A 10 ~ 50ms delay time is typical for most applications.

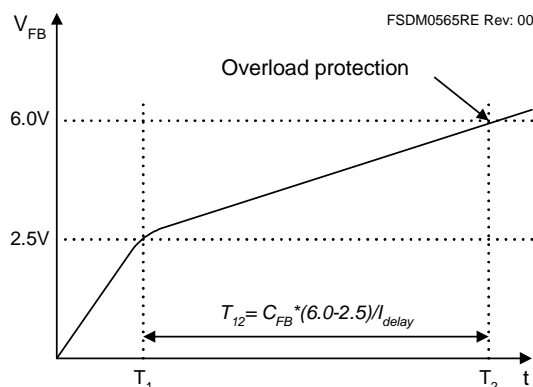

Figure 20. Overload Protection

3.2 Over-Voltage Protection (OVP): If the secondary side feedback circuit were to malfunction or a solder defect caused an opening in the feedback path, the current through the opto-coupler transistor becomes almost zero. In this event, V_{FB} climbs in a similar manner to the overload situation, forcing the preset maximum current to be supplied to the SMPS until the overload protection is activated. Because more energy than required is provided to the output, the output voltage may exceed the rated voltage before the overload protection is activated, resulting in the breakdown of the devices in the secondary side. To prevent this situation, an over-voltage protection (OVP) circuit is employed. In general, V_{CC} is proportional to the output voltage and the FSDM0x65RE uses V_{CC} instead of directly monitoring the output voltage. If V_{CC} exceeds 19V, an OVP circuit is activated, resulting in the termination of the switching operation. To avoid undesired activation of OVP during normal operation, V_{CC} should be designed below 19V.

3.3 Thermal Shutdown (TSD): The SenseFET and the control IC are built in one package. This makes it easy for the control IC to detect the heat generation from the SenseFET. When the temperature exceeds ~150°C, the thermal shutdown is activated.

4. Soft-Start: The FSDM0x65RE has an internal soft-start circuit that increases PWM comparator inverting input voltage, together with the SenseFET current, slowly after it starts up. The typical soft-start time is 10ms. The pulse width to the power switching device is progressively increased to establish the correct working conditions for transformers, inductors, and capacitors. The voltage on the output capacitors is progressively increased with the intention of smoothly establishing the required output voltage. It also helps prevent transformer saturation and reduces the stress on the secondary diode during start-up.

5. Burst Operation: To minimize power dissipation in standby mode, the FSDM0x65RE enters burst-mode operation. As the load decreases, the feedback voltage decreases. As shown in Figure 21, the device automatically enters burst mode when the feedback voltage drops below V_{BURL} (500mV). At this point, switching stops and the output voltages start to drop at a rate dependent on standby current load. This causes the feedback voltage to rise. Once it passes V_{BURH} (700mV), switching resumes. The feedback voltage then falls and the process repeats. Burst-mode operation alternately enables and disables switching of the power SenseFET, thereby reducing switching loss in standby mode.

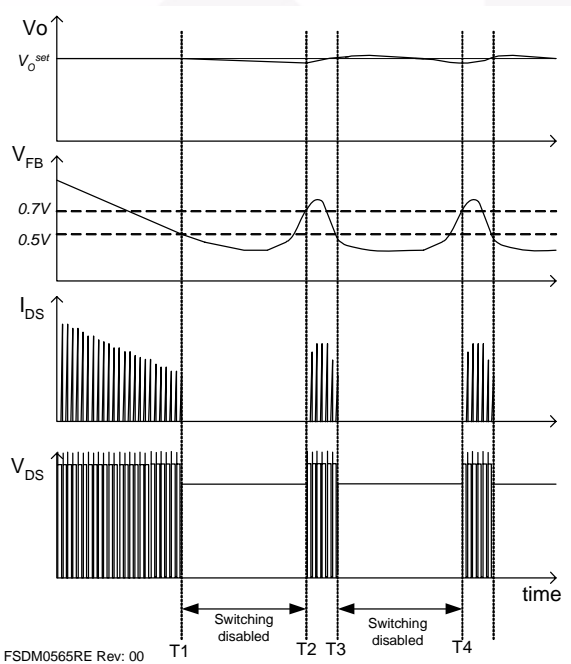

Figure 21. Waveforms of Burst Operation

Application Information

Application	Output Power	Input Voltage	Output Voltage (Max. Current)
LCD Monitor	40W	Universal input (85-265V _{AC})	5V (2.0A) 12V (2.5A)

Features

- High efficiency (>81% at 85V_{AC} input)
- Low zero load power consumption (<300mW at 240V_{AC} input)
- Low standby mode power consumption (<800mW at 240V_{AC} input and 0.3W load)
- Low component count
- Enhanced system reliability through various protection functions
- Internal soft-start (10ms)

Key Design Notes

- Resistors R102 and R105 are employed to prevent start-up at low input voltage. After start-up, there is no power loss in these resistors since the start-up pin is internally disconnected after start-up.
- The delay time for overload protection is designed to be about 50ms with C106 of 47nF. If a faster triggering of OLP is required, C106 can be reduced to 10nF.
- Zener diode ZD102 is used for a safety test, such as UL. When the drain pin and feedback pin are shorted, the zener diode fails and remains short, which causes the fuse (F1) to be blown and prevents explosion of the opto-coupler (IC301). This zener diode also increases the immunity against line surge.

1. Schematic

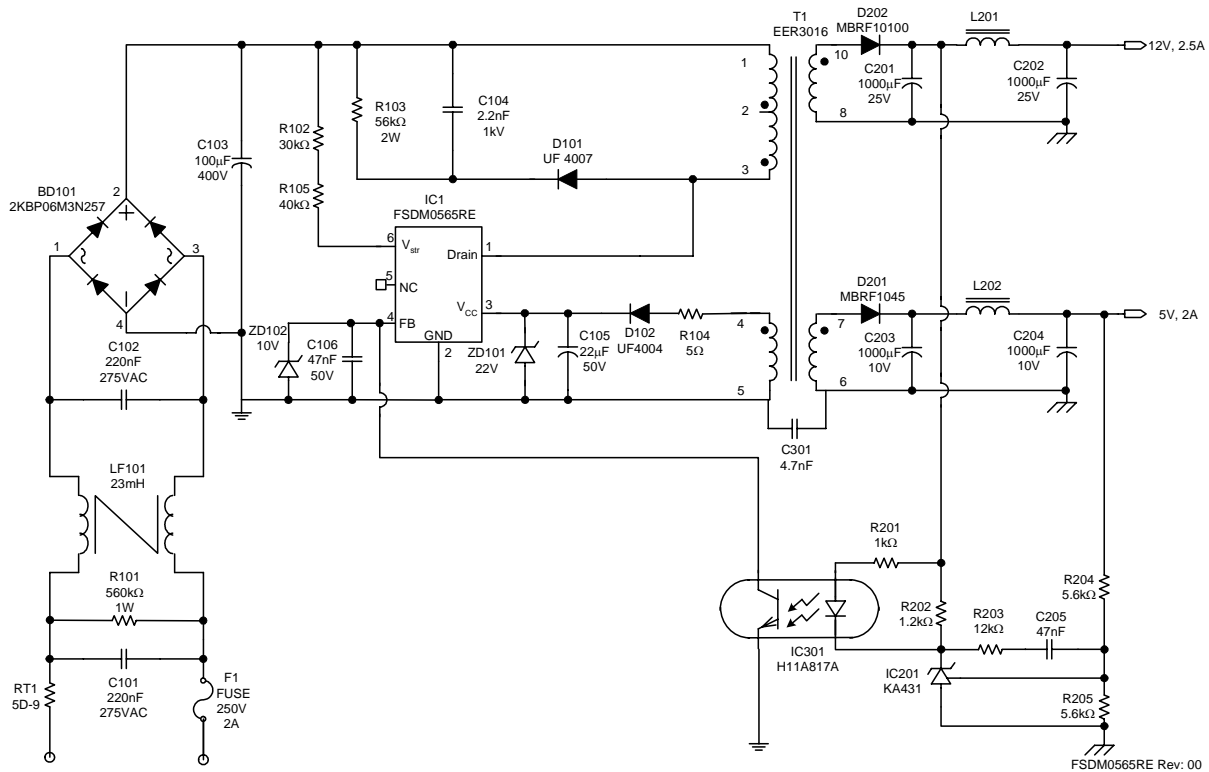

Figure 22. Demo Circuit

2. Transformer

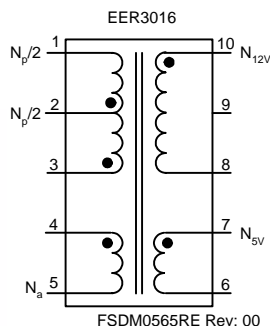

Figure 23. Transformer Schematic Diagram

3. Winding Specification

No	Pin (s→f)	Wire	Turns	Winding Method
N_a	4 → 5	$0.2^\phi \times 1$	8	Center Winding
Insulation: Polyester Tape $t = 0.050\text{mm}$, 2 Layers				
$N_{p/2}$	2 → 1	$0.4^\phi \times 1$	18	Solenoid Winding
Insulation: Polyester Tape $t = 0.050\text{mm}$, 2 Layers				
N_{12V}	10 → 8	$0.3^\phi \times 3$	7	Center Winding
Insulation: Polyester Tape $t = 0.050\text{mm}$, 2 Layers				
N_{5V}	7 → 6	$0.3^\phi \times 3$	3	Center Winding
Insulation: Polyester Tape $t = 0.050\text{mm}$, 2 Layers				
$N_{p/2}$	3 → 2	$0.4^\phi \times 1$	18	Solenoid Winding
Outer Insulation: Polyester Tape $t = 0.050\text{mm}$, 2 Layers				

4. Electrical Characteristics

	Pin	Specification	Remarks
Inductance	1 - 3	$520\mu\text{H} \pm 10\%$	100kHz, 1V
Leakage Inductance	1 - 3	10 μH Max	2 nd all short

5. Core & Bobbin

- Core: EER 3016
- Bobbin: EER3016
- $A_e(\text{mm}^2)$: 96

6. Demo Circuit Part List

Part	Value	Note	Part	Value	Note
Fuse			D102	UF4004	
F101	2A/250V		D201	MBRF1045	
			D202	MBRF10100	
NTC			ZD101	Zener Diode	22V
RT101	5D-9		ZD102	Zener Diode	10V
Resistor			Bridge Diode		
R101	560kΩ	1W	BD101	2KBP06M 3N257	Bridge Diode
R102	30kΩ	1/4W			
R103	56kΩ	2W	Line Filter		
R104	5Ω	1/4W	LF101	23mH	Wire 0.4mm
R105	40kΩ	1/4W			
R201	1kΩ	1/4W	IC		
R202	1.2kΩ	1/4W	IC101	FSDM0565RE	FPS™ (5A,650V)
R203	12kΩ	1/4W	IC201	KA431 (TL431)	Voltage reference
R204	5.6kΩ	1/4W	IC301	H11A817A	Opto-coupler
R205	5.6kΩ	1/4W			
Capacitor					
C101	220nF/275V _{AC}	Box Capacitor			
C102	220nF/275V _{AC}	Box Capacitor			
C103	100μF/400V	Electrolytic Capacitor			
C104	2.2nF/1kV	Ceramic Capacitor			
C105	22μF/50V	Electrolytic Capacitor			
C106	47nF/50V	Ceramic Capacitor			
C201	1000μF/25V	Electrolytic Capacitor			
C202	1000μF/25V	Electrolytic Capacitor			
C203	1000μF/10V	Electrolytic Capacitor			
C204	1000μF/10V	Electrolytic Capacitor			
C205	47nF/50V	Ceramic Capacitor			
C301	4.7nF	Polyester Film Cap.			
Inductor					
L201	5μH	Wire 1.2mm			
L202	5μH	Wire 1.2mm			
Diode					
D101	UF4007				

7. Layout

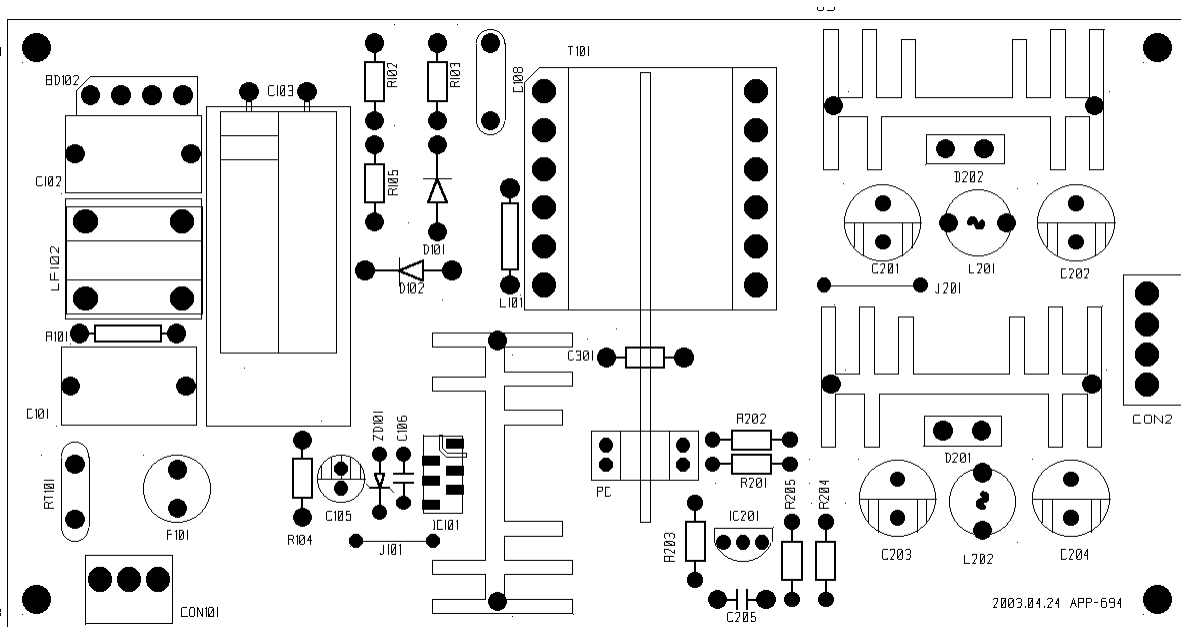

Figure 24. Layout Considerations for FSDM0565RE (Top View)

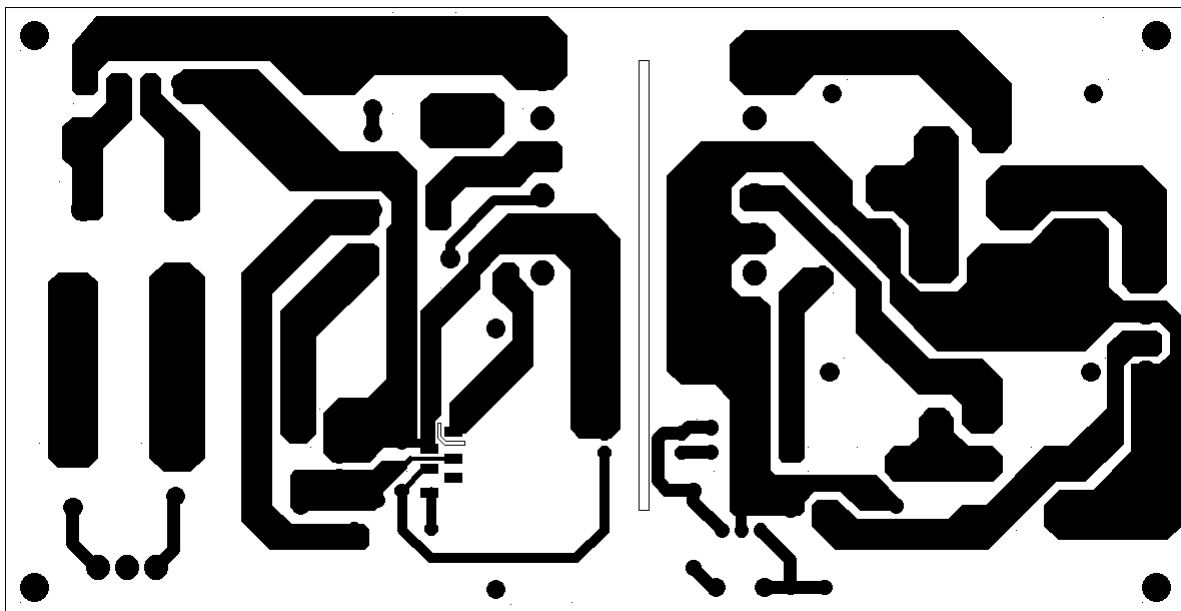
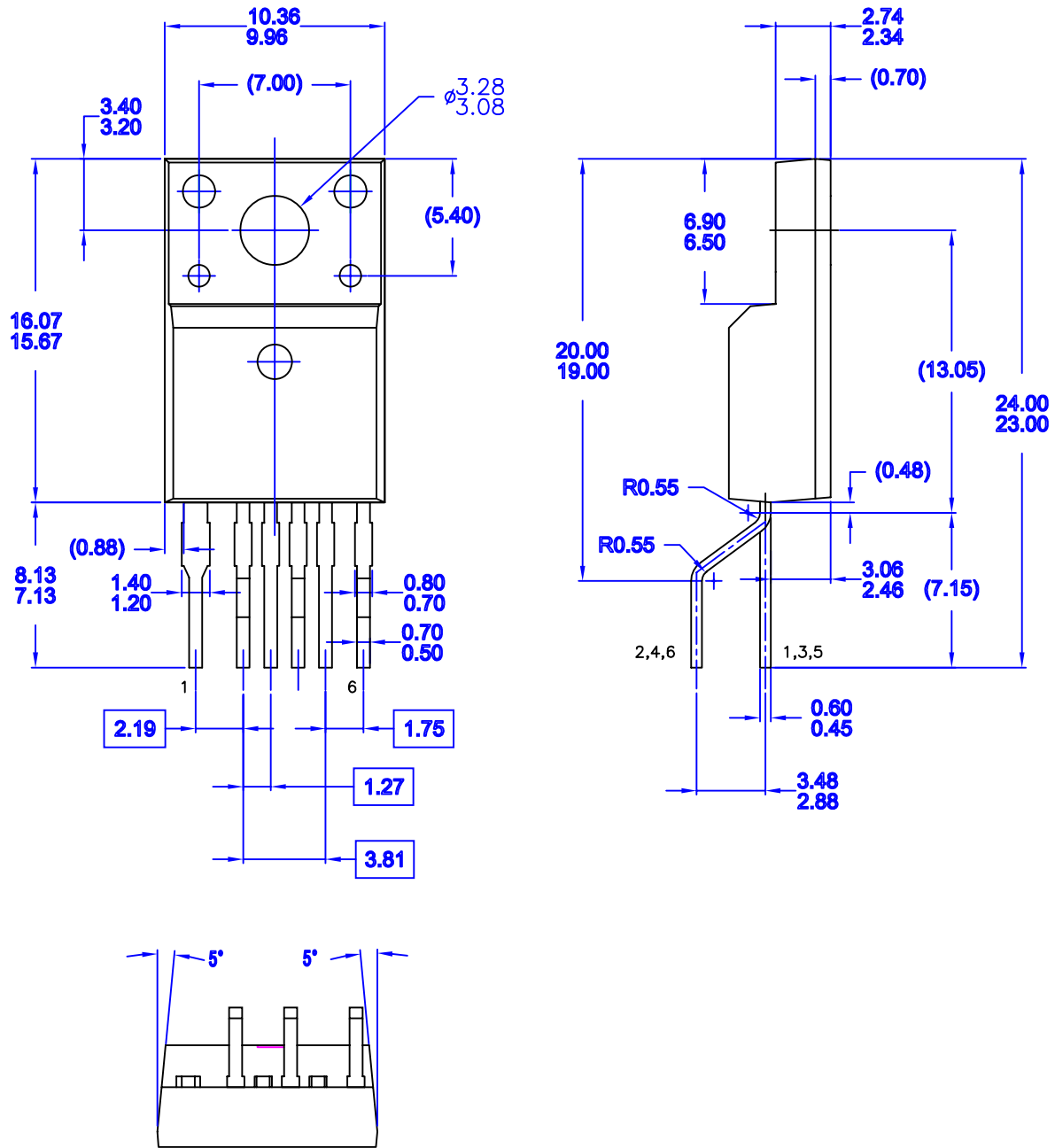

Figure 25. Layout Considerations for FSDM0565RE (Bottom View)

Package Dimensions



MKT-TO220A06revB

NOTES: UNLESS OTHERWISE SPECIFIED
 A) THIS PACKAGE DOES NOT COMPLY TO ANY CURRENT PACKAGING STANDARD.
 B) ALL DIMENSIONS ARE IN MILLIMETERS.
 C) DIMENSIONS ARE EXCLUSIVE OF BURRS, MOLD FLASH, AND TIE BAR EXTRUSIONS.
 D) LEADFORM OPTION A

Figure 26. TO-220F-6L (Forming)



TRADEMARKS

The following are registered and unregistered trademarks and service marks Fairchild Semiconductor owns or is authorized to use and is not intended to be an exhaustive list of all such trademarks.

ACE ^x	Green FPS™	Power247 [®]	SuperSOT™-8
Build it Now™	Green FPS™ e-Series™	POWEREDGE [®]	SyncFET™
CorePLUS™	GTQ™	Power-SPM™	The Power Franchise [®]
CROSSVOLT™	i-Lo™	PowerTrench [®]	the power franchise
CTL™	IntelliMAX™	Programmable Active Droop™	TinyBoost™
Current Transfer Logic™	ISOPLANAR™	QFET [®]	TinyBuck™
EcoSPARK [®]	MegaBuck™	QS™	TinyLogic [®]
F [®]	MICROCOUPLER™	QT Optoelectronics™	TINYOPTO™
Fairchild [®]	MicroFET™	Quiet Series™	TinyPower™
Fairchild Semiconductor [®]	MicroPak™	RapidConfigure™	TinyPWM™
FACT Quiet Series™	MillerDrive™	SMART START™	TinyWire™
FACT [®]	Motion-SPM™	SPM [®]	μSerDes™
FAST [®]	OPTOLOGIC [®]	STEALTH™	UHC [®]
FastvCore™	OPTOPLANAR [®]	SuperFET™	UniFET™
FPST™		SuperSOT™-3	VCX™
FRFET [®]	PDP-SPM™	SuperSOT™-6	
Global Power Resource SM	Power220 [®]		

DISCLAIMER

FAIRCHILD SEMICONDUCTOR RESERVES THE RIGHT TO MAKE CHANGES WITHOUT FURTHER NOTICE TO ANY PRODUCTS HEREIN TO IMPROVE RELIABILITY, FUNCTION, OR DESIGN. FAIRCHILD DOES NOT ASSUME ANY LIABILITY ARISING OUT OF THE APPLICATION OR USE OF ANY PRODUCT OR CIRCUIT DESCRIBED HEREIN; NEITHER DOES IT CONVEY ANY LICENSE UNDER ITS PATENT RIGHTS, NOR THE RIGHTS OF OTHERS. THESE SPECIFICATIONS DO NOT EXPAND THE TERMS OF FAIRCHILD'S WORLDWIDE TERMS AND CONDITIONS, SPECIFICALLY THE WARRANTY THEREIN, WHICH COVERS THESE PRODUCTS.

LIFE SUPPORT POLICY

FAIRCHILD'S PRODUCTS ARE NOT AUTHORIZED FOR USE AS CRITICAL COMPONENTS IN LIFE SUPPORT DEVICES OR SYSTEMS WITHOUT THE EXPRESS WRITTEN APPROVAL OF FAIRCHILD SEMICONDUCTOR CORPORATION.

As used herein:

- Life support devices or systems are devices or systems which, (a) are intended for surgical implant into the body or (b) support or sustain life, and (c) whose failure to perform when properly used in accordance with instructions for use provided in the labeling, can be reasonably expected to result in a significant injury of the user.
- A critical component in any component of a life support device, or system whose failure to perform can be reasonably expected to cause the failure of the life support device or system, or to affect its safety or effectiveness.

PRODUCT STATUS DEFINITIONS

Definition of Terms

Datasheet Identification	Product Status	Definition
Advance Information	Formative or In Design	This datasheet contains the design specifications for product development. Specifications may change in any manner without notice.
Preliminary	First Production	This datasheet contains preliminary data; supplementary data will be published at a later date. Fairchild Semiconductor reserves the right to make changes at any time without notice to improve design.
No Identification Needed	Full Production	This datasheet contains final specifications. Fairchild Semiconductor reserves the right to make changes at any time without notice to improve design.
Obsolete	Not In Production	This datasheet contains specifications on a product that has been discontinued by Fairchild Semiconductor. The datasheet is printed for reference information only.

Rev. 131

AMEYA360

Components Supply Platform

Authorized Distribution Brand :



Website :

Welcome to visit www.ameya360.com

Contact Us :

➤ Address :

401 Building No.5, JiuGe Business Center, Lane 2301, Yishan Rd
Minhang District, Shanghai , China

➤ Sales :

Direct +86 (21) 6401-6692

Email amall@ameya360.com

QQ 800077892

Skype [ameyasales1](#) [ameyasales2](#)

➤ Customer Service :

Email service@ameya360.com

➤ Partnership :

Tel +86 (21) 64016692-8333

Email mkt@ameya360.com