



## Features

- Shielded construction
- Inductance range: 10 to 1000  $\mu$ H
- Heating current up to 2.1 A
- Dimensions: 7.3 x 7.3 x 4.5 mm
- AEC-Q200 qualified
- RoHS compliant\* and halogen free\*\*

## Applications

- Automotive systems:
  - Driver assistant
  - Entertainment
  - Information
  - Lighting
- DC/DC converters
- Power supplies

# SRR0745A Series - Shielded Power Inductors

### Electrical Specifications @ 25 °C

Bourns Part Number	Inductance @ 1 kHz / 1 V		DCR ( $\Omega$ ) Max.	I rms (A)	I sat (A)
	L ( $\mu$ H)	Tol. (%)			
SRR0745A-100M	10	$\pm 20$	0.052	2.1	2.5
SRR0745A-120M	12	$\pm 20$	0.062	2.0	2.3
SRR0745A-150M	15	$\pm 20$	0.075	1.9	2.1
SRR0745A-180M	18	$\pm 20$	0.09	1.8	1.95
SRR0745A-220M	22	$\pm 20$	0.096	1.65	1.75
SRR0745A-270M	27	$\pm 20$	0.13	1.45	1.62
SRR0745A-330M	33	$\pm 20$	0.15	1.35	1.45
SRR0745A-390M	39	$\pm 20$	0.19	1.17	1.3
SRR0745A-470M	47	$\pm 20$	0.21	1.05	1.2
SRR0745A-560M	56	$\pm 20$	0.24	0.95	1.1
SRR0745A-680M	68	$\pm 20$	0.3	0.86	0.96
SRR0745A-820M	82	$\pm 20$	0.4	0.78	0.9
SRR0745A-101M	100	$\pm 20$	0.45	0.7	0.78
SRR0745A-121M	120	$\pm 20$	0.55	0.6	0.7
SRR0745A-151M	150	$\pm 20$	0.76	0.48	0.58
SRR0745A-181M	180	$\pm 20$	0.82	0.46	0.54
SRR0745A-221M	220	$\pm 20$	0.95	0.42	0.5
SRR0745A-271M	270	$\pm 20$	1.2	0.38	0.46
SRR0745A-331M	330	$\pm 20$	1.5	0.34	0.4
SRR0745A-391M	390	$\pm 20$	1.85	0.32	0.36
SRR0745A-471M	470	$\pm 20$	2.2	0.29	0.34
SRR0745A-561M	560	$\pm 20$	2.6	0.26	0.3
SRR0745A-681M	680	$\pm 20$	2.8	0.24	0.28
SRR0745A-821M	820	$\pm 20$	3.5	0.22	0.26
SRR0745A-102M	1000	$\pm 20$	4.1	0.2	0.24

### How to Order

**SRR0745A - 100M**

Model \_\_\_\_\_  
Value Code (see table) \_\_\_\_\_

### Electrical Schematic

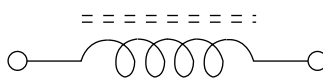

### General Specifications

Operating Temperature .....-40 °C to +125 °C  
(Temperature rise included)  
Storage Temperature .....-40 °C to +125 °C  
Resistance to Solder Heat .....+250 °C for 10 sec.  
Temperature Rise .....40 °C typ. at rated I rms  
Inductance drop..... 25 % at I sat

### Materials

Core.....Ferrite  
Wire.....Enameled copper  
Terminal Finish.....Sn  
Packaging..... 1000 pcs. per reel

### Product Dimensions

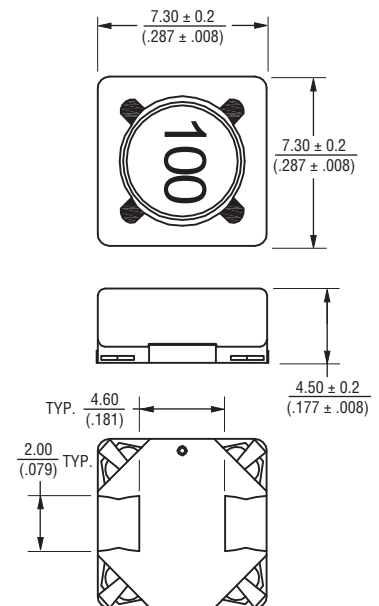

### Recommended Layout

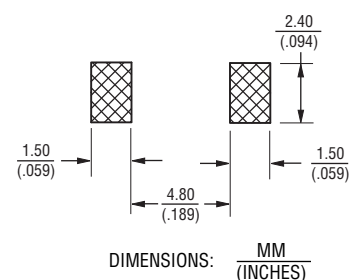

# BOURNS®

**Asia-Pacific:** Tel: +886-2 2562-4117 • Fax: +886-2 2562-4116  
**EMEA:** Tel: +36 88 520 390 • Fax: +36 88 520 211  
**The Americas:** Tel: +1-951 781-5500 • Fax: +1-951 781-5700  
[www.bourns.com](http://www.bourns.com)

\* RoHS Directive 2002/95/EC Jan. 27, 2003 including annex and RoHS Recast 2011/65/EU June 8, 2011.  
 \*\* Bourns follows the prevailing definition of "halogen free" in the industry. Bourns considers a product to be "halogen free" if (a) the Bromine (Br) content is 900 ppm or less; (b) the Chlorine (Cl) content is 900 ppm or less; and (c) the total Bromine (Br) and Chlorine (Cl) content is 1500 ppm or less.  
 Specifications are subject to change without notice.  
 The device characteristics and parameters in this data sheet can and do vary in different applications and actual device performance may vary over time.  
 Users should verify actual device performance in their specific applications.

# SRR0745A Series - Shielded Power Inductors

**BOURNS®**

## Inductance vs. IDC

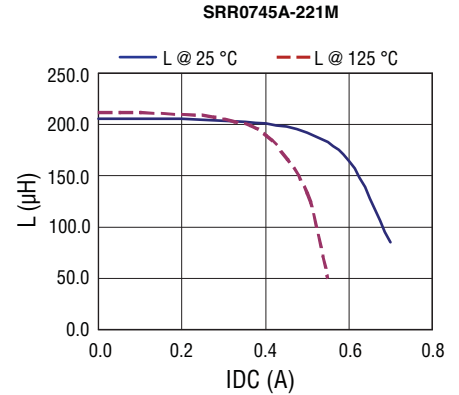
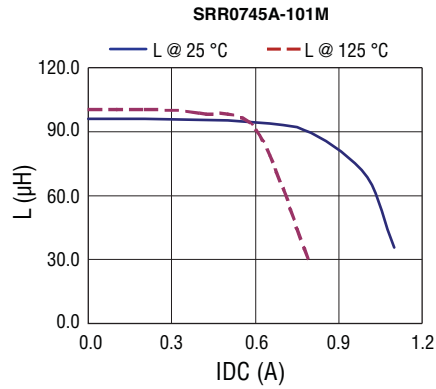
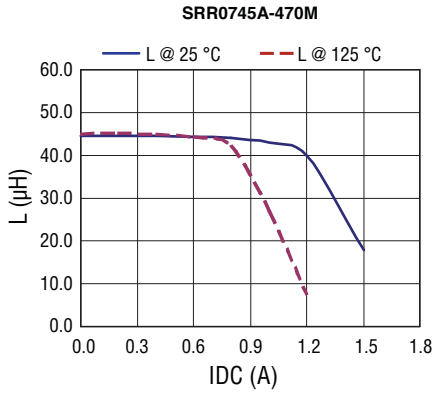

## Temperature Rise vs. IDC

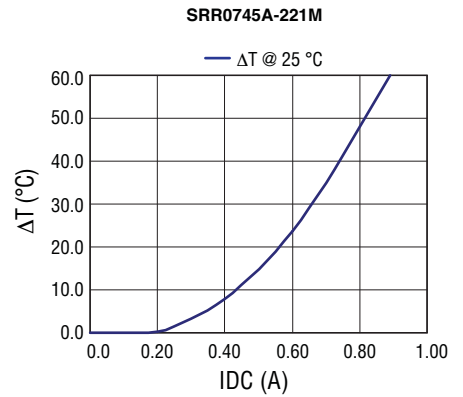
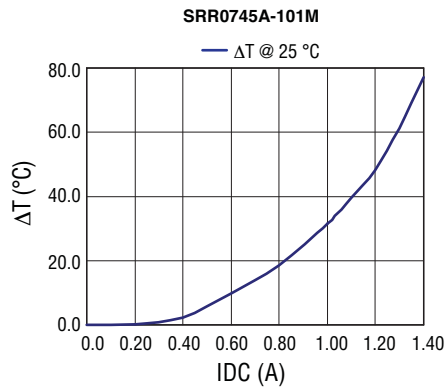
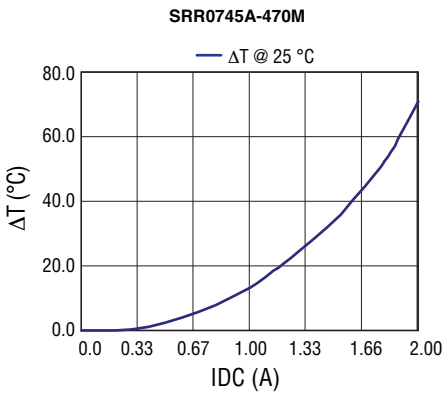

Specifications are subject to change without notice. The device characteristics and parameters in this data sheet can and do vary in different applications and actual device performance may vary over time. Users should verify actual device performance in their specific applications.

# SRR0745A Series - Shielded Power Inductors

**BOURNS®**

## Soldering Profile

Peak Temperature: 250 °C max.  
 Max. Peak Temperature -5 °C: 30 sec. max.  
 Max. Time Above 217 °C: 60-150 sec. max.

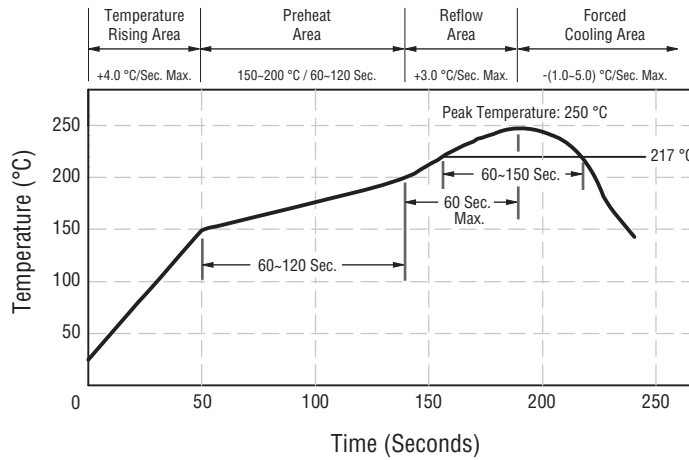

## Packaging Specifications

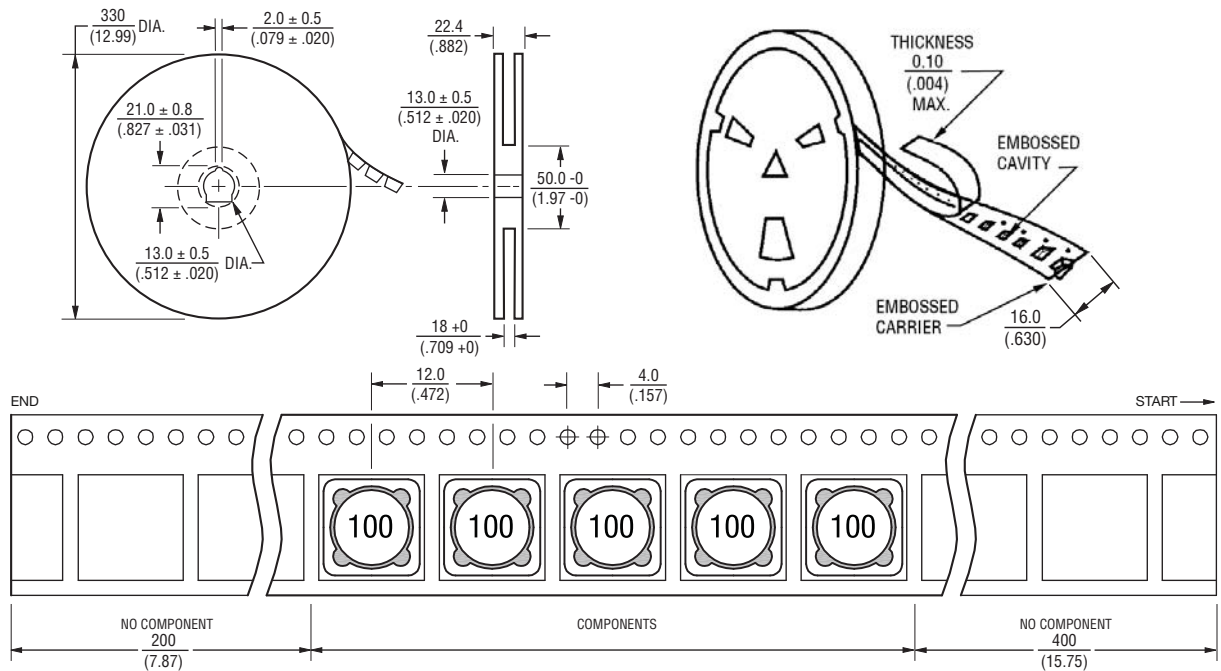

USER DIRECTION OF FEED →

QTY: 1000 PCS. PER REEL

DIMENSIONS:  $\frac{\text{MM}}{\text{(INCHES)}}$

# AMEYA360

## Components Supply Platform

Authorized Distribution Brand :



Website :

Welcome to visit [www.ameya360.com](http://www.ameya360.com)

Contact Us :

➤ Address :

401 Building No.5, JiuGe Business Center, Lane 2301, Yishan Rd  
Minhang District, Shanghai , China

➤ Sales :

Direct +86 (21) 6401-6692

Email [amall@ameya360.com](mailto:amall@ameya360.com)

QQ 800077892

Skype [ameyasales1](#) [ameyasales2](#)

➤ Customer Service :

Email [service@ameya360.com](mailto:service@ameya360.com)

➤ Partnership :

Tel +86 (21) 64016692-8333

Email [mkt@ameya360.com](mailto:mkt@ameya360.com)