

FIBRE WASHER

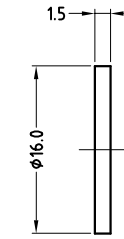

NUT OPTIONS

PLASTIC NUT

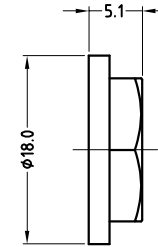

METAL NUT

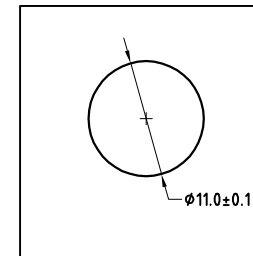
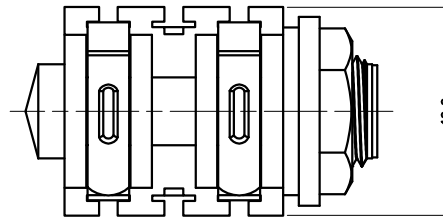
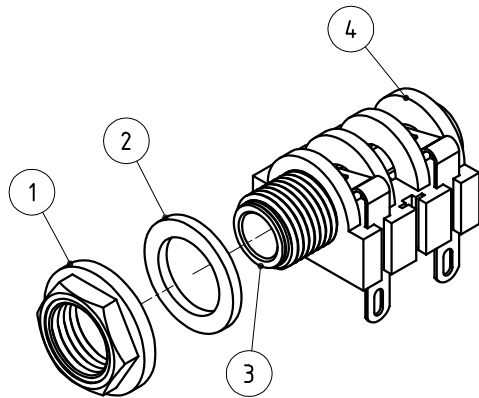
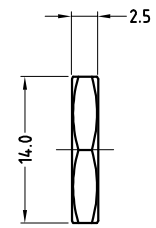

PANEL CUTOUT

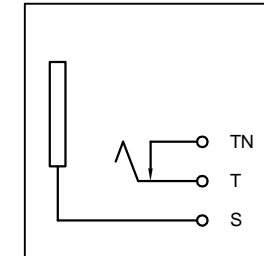

SCHEMATIC

ITEM	DESCRIPTION
1	METAL/PLASTIC NUT
2	FIBRE WASHER
3	METAL TUBE INSERT
4	CONNECTOR ASSEMBLY

PART No.	CATALOG No.	DESCRIPTION
55010292-000	ACJM-MHS	METAL NUT
55010292-001	ACJM-PHS	PLASTIC NUT

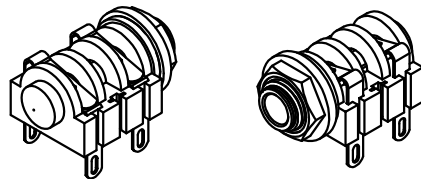

ISO VIEW

UNLESS OTHERWISE SPECIFIED TOLERANCE TO BE	
LINEAR	ANGULAR
X ± 0.5	X° ± 1°
X.X ± 0.1	X°X' ± 30'
X.XX ± 0.05	X°X'X" ± 15"

BREAK ALL SHARP EDGES AND REMOVE ALL BURRS

DO NOT SCALE

DIMENSIONS IN MILLIMETRES

THIS DOCUMENT IS THE PROPERTY OF AMPHENOL AUSTRALIA PTY. LTD.. NO PART THEREOF MAY BE REPRODUCED AND USED WITHOUT THE PRIOR WRITTEN CONSENT OF THE OWNER

CAD FILE: 55010292000111

MATL: REFER TO COMPONENT

FINISH: REFER TO COMPONENT

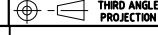

DRN: L.V DATE: 17-10-01

CKD: M.N.H DATE: 13-01-06

APP'D: P.M DATE: 13-01-06

SCALE: 2:1 UOS

REV.	CHANGE DETAILS	BY	DATE	CHG/No
1	CHANGE PART VARIATION NUMBER IN TABLE UPDATE DRAWING TO CURRENT PART	L.V	07-07-04	8293
0	FIRST ISSUE	L.V	17-10-01	----

TITLE:
ACJM-MHS/ACJM-PHS
1/4" MONO JACK
CUSTOMER DRAWING

Amphenol
Amphenol Australia Pty Ltd, 2 Fineways Blvd, Keysborough, Vic 3173
DRAWING NO. SHEET

PART No: REFER TO TABLE SIZE: A3 55010292-000-1 1 OF 1

AMEYA360

Components Supply Platform

Authorized Distribution Brand :



Website :

Welcome to visit www.ameya360.com

Contact Us :

➤ Address :

401 Building No.5, JiuGe Business Center, Lane 2301, Yishan Rd
Minhang District, Shanghai , China

➤ Sales :

Direct +86 (21) 6401-6692

Email amall@ameya360.com

QQ 800077892

Skype ameyasales1 ameyasales2

➤ Customer Service :

Email service@ameya360.com

➤ Partnership :

Tel +86 (21) 64016692-8333

Email mkt@ameya360.com