



Designers' Choice

TRANSISTOR SOCKETS KITS

- LABOR SAVING • EASY MOUNTING TO CHASSIS • BETTER THERMAL EFFICIENCY

An improved, simpler, less costly method of semiconductor mounting. Avoid soldering directly to the semiconductor. Easier to service, economical, more efficient.

ORDERING INFORMATION:

Complete Kits or Individual Hardware

Purchase the complete kit by catalog number as shown or individual items in minimum 100 piece packages. Keystone does not supply semiconductors.

SPECIFICATIONS

Socket

Base: Phenolic, XP grade
 Contacts: Brass, Tin Plate
 Top Plate: Nylon per ASTM-D4066
 Collector Plate: .030 Steel, Tin Plate

Screws

Steel, Type B, 4-40 or 6-20 as required

Mica

.003 Thick

SOCKET MOUNTING FOR TO-3 CASE

The socket and transistor are assembled without previous attachment to the chassis. Contacts are spaced .430 apart. The .045 high boss on the nylon top eliminates the need of washers or bushings.

ITEM	CAT. NO.	DESCRIPTION	QUANTITY
A	4706	6-20 screws	2
B	4651	Mica Insulator	1
C	4602	Socket	1

CAT. NO. 4732 Complete Mounting Kit (includes all of the above)

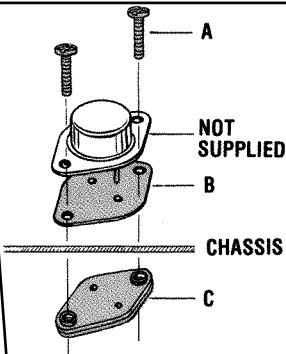

SOCKET ONLY

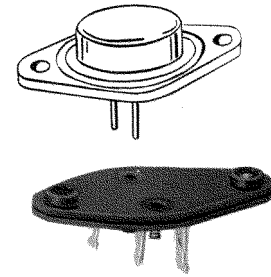

CAT. NO. 4602

SOCKET MOUNTING FOR TO-3 CASE

These sockets are pre-assembled to the chassis by either eyelets or rivets. Spacing of contacts is .430 centers. The .045 high boss on the nylon top eliminates the need of washers or bushings.

ITEM	CAT. NO.	DESCRIPTION	QUANTITY
A	4706	6-20 screws	2
B	4651	Mica Insulator	1
C	4608	Square Socket	1

CAT. NO. 4733 Complete Mounting Kit (includes all of the above)

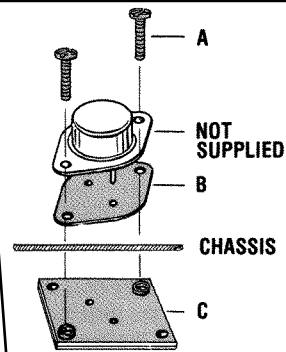

SOCKET ONLY

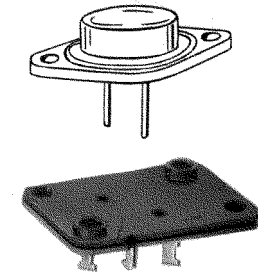

CAT. NO. 4608

SOCKET MOUNTING FOR TO-3 CASE

An all phenolic socket that is pre-assembled to the chassis by eyelets or rivets. Spacing and brass contacts .430 centers.

ITEM	CAT. NO.	DESCRIPTION	QUANTITY
A	4706	6-20 screws	2
B	4651	Mica Insulator	1
C	4684	Nylon Bushings	4
D	4606	Sq. Phenol. Socket	1

CAT. NO. 4734 Complete Mounting Kit (includes all of the above)

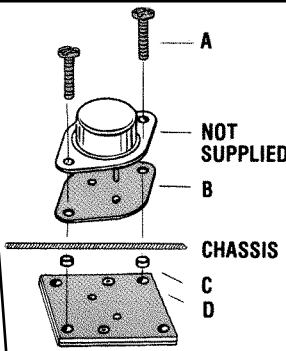

SOCKET ONLY

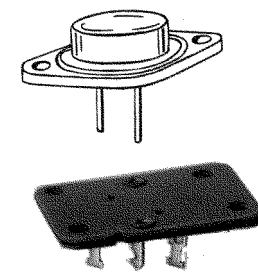

CAT. NO. 4606

NYLON POWER TRANSISTOR MOUNT

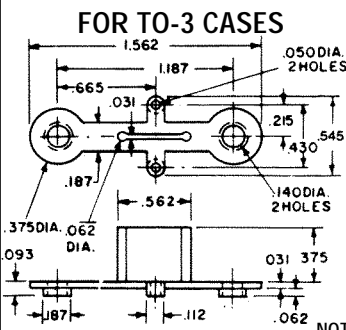

Barrier insulator, molded of type 6/6 natural colored nylon, functionally replaces up to six pieces of conventional insulation required with previous methods of mounting power transistors. Built-in barrier eliminates need for sleeving of connections.

CAT. NO. 4616

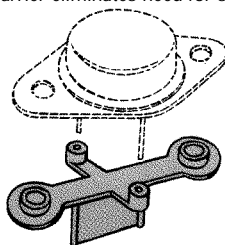

CAT. NO. 4617

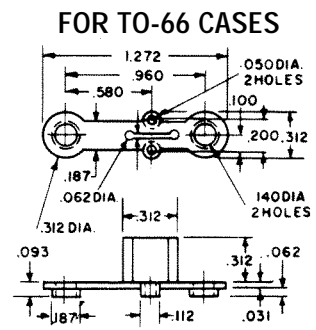

NOTE: Heavy Duty Insulator made of celanex available. Samples and quote upon request.

AMEYA360

Components Supply Platform

Authorized Distribution Brand :



Website :

Welcome to visit www.ameya360.com

Contact Us :

➤ Address :

401 Building No.5, JiuGe Business Center, Lane 2301, Yishan Rd
Minhang District, Shanghai , China

➤ Sales :

Direct +86 (21) 6401-6692

Email amall@ameya360.com

QQ 800077892

Skype [ameyasales1](#) [ameyasales2](#)

➤ Customer Service :

Email service@ameya360.com

➤ Partnership :

Tel +86 (21) 64016692-8333

Email mkt@ameya360.com