

## 150 mA capless ultra low drop linear regulator ICs

Datasheet - production data



### Description

The LDCL015 provides 150 mA of maximum current from an input voltage ranging from 1.8 V to 5.5 V, with a typical dropout voltage of 50 mV. It is stable with no input or output capacitor. Low quiescent current, low noise and capless operation make it suitable for low power battery-powered applications and allows the reduction of board size. Typical power supply rejection ratio is 52 dB at low frequencies, and starts to roll off at 10 kHz. The Enable logic control function puts the LDCL015 in shutdown mode, reducing the total current consumption to less than 1  $\mu$ A. The device also includes short-circuit constant current limit and thermal protection. Typical applications are mobile phones, personal digital assistants and similar battery-powered systems.

### Features

- No input or output capacitor required
- Input voltage from 1.8 V to 5.5 V
- Very low drop: 50 mV at 100 mA load
- $\pm 2\%$  output voltage accuracy
- Output voltage tolerance over temperature:  $\pm 3\%$
- Low noise
- 150 mA guaranteed output current
- Available in fixed and adjustable output voltages, from 0.8 V in 100 mV steps
- Internal current and thermal limit
- Operating temperature range: - 40 °C to 125 °C
- SOT23 5-lead package

### Applications

- Space-sensitive applications
- Battery-powered equipment
- Cordless and mobile phones
- Industrial and medical equipment
- Portable equipment

**Table 1. Device summary**

Markings	Order codes	Output voltages
CL33	LDCL015M33R	3.3 V
CLAD	LDCL015MR	Adjustable from 0.8

# Contents

<b>1</b>	<b>Block diagram</b> .....	<b>3</b>
<b>2</b>	<b>Pin configuration</b> .....	<b>4</b>
<b>3</b>	<b>Typical application</b> .....	<b>5</b>
<b>4</b>	<b>Maximum ratings</b> .....	<b>6</b>
<b>5</b>	<b>Electrical characteristics</b> .....	<b>7</b>
<b>6</b>	<b>Typical performance characteristics</b> .....	<b>8</b>
<b>7</b>	<b>Application information</b> .....	<b>11</b>
	7.1 General operation .....	11
	7.2 Thermal and short-circuit protection .....	11
	7.3 Output voltage setting for ADJ version .....	11
	7.4 Enable pin .....	11
<b>8</b>	<b>Package mechanical data</b> .....	<b>12</b>
<b>9</b>	<b>Packaging mechanical data</b> .....	<b>14</b>
<b>10</b>	<b>Revision history</b> .....	<b>16</b>

# 1 Block diagram

Figure 1. LDCL015 block diagram

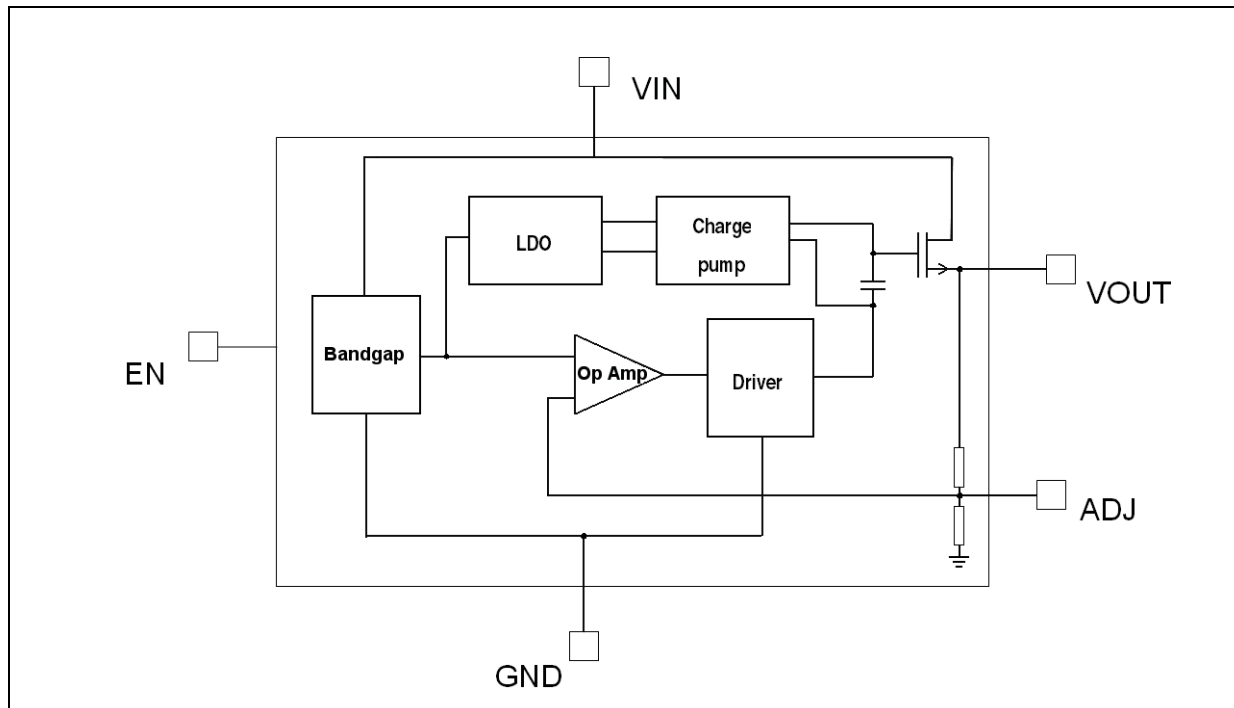

## 2 Pin configuration

Figure 2. Pin connections (top view)

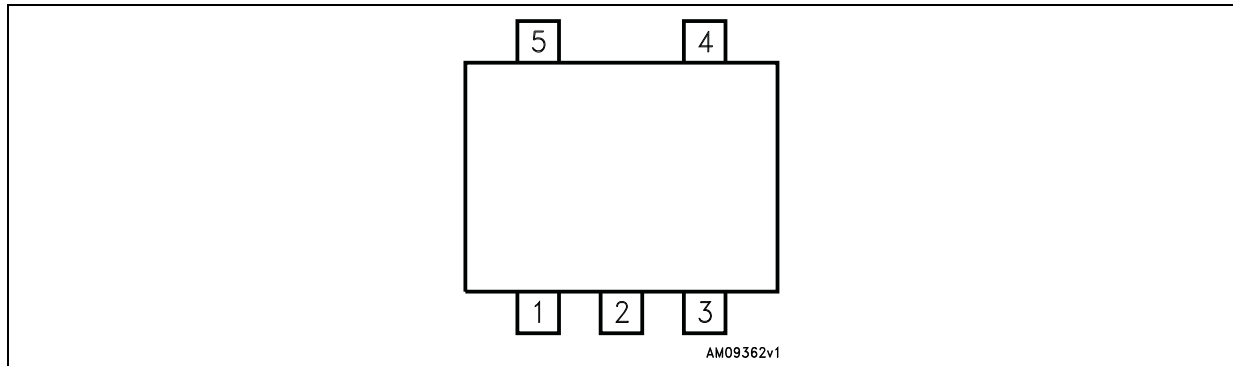

Table 2. Pin description

Pin n°	Symbol	Name and function
1	$V_{IN}$	Input voltage
2	GND	Ground
3	EN	Enable pin. The device is in OFF state when this pin is pulled low
4	ADJ/NC	Feedback pin for adjustable version. Not connected on fixed version
5	$V_{OUT}$	Output voltage

### 3 Typical application

Figure 3. Typical application schematic - adjustable version

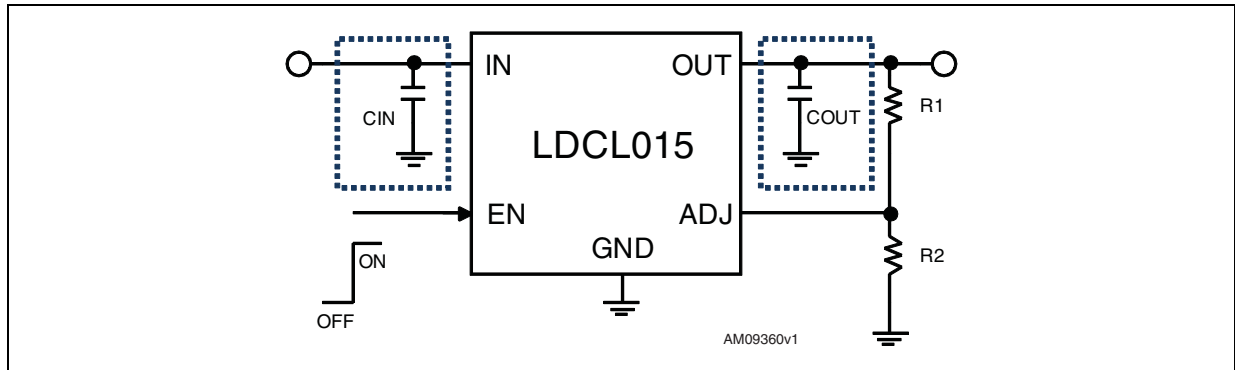
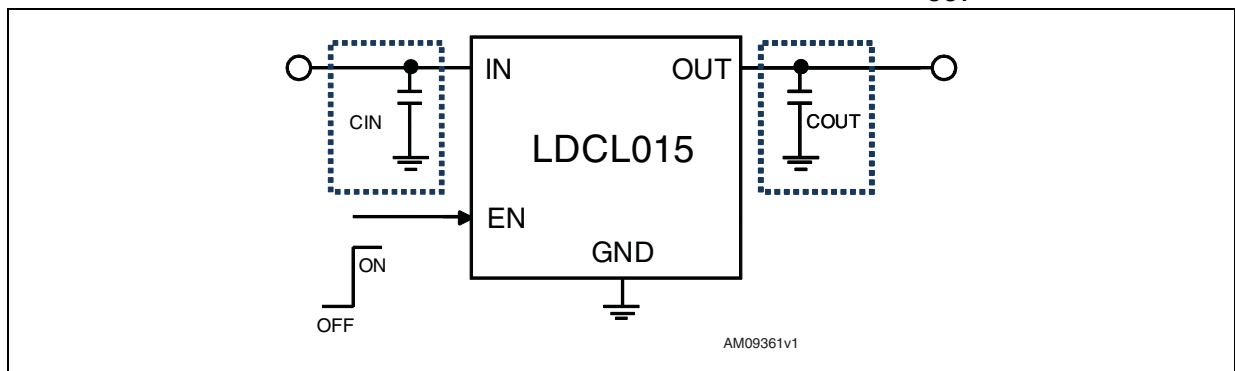

Figure 4. Typical application schematic - fixed  $V_{OUT}$  version



- Note:
- 1  $R1$  and  $R2$  are calculated according to the following formula:  $R1 = R2 \times (V_{OUT}/V_{ADJ} - 1)$ .
  - 2  $C_{IN}$  and  $C_{OUT}$  are optional.

## 4 Maximum ratings

**Table 3. Absolute maximum ratings**

Symbol	Parameter	Value	Unit
$V_{IN}$	Input supply voltage	-0.3 to +7	V
$V_{OUT}$	Output voltage	-0.3 to $V_{IN} + 0.3$	V
$I_{OUT}$	Output current	Internally limited	A
EN, ADJ	Enable and feedback pin voltage	-0.3 to $+V_{IN} + 0.3$	V
$P_D$	Power dissipation	Internally limited	W
ESD	Machine model	$\pm 300$	V
	Human body model	$\pm 3000$	
$T_{J-OP}$	Operating junction temperature	-40 to 125	°C
$T_{J-MAX}$	Maximum junction temperature	150	°C
$T_{STG}$	Storage temperature	-65 to 150	°C

*Note: Absolute maximum ratings are those values beyond which damage to the device may occur. Functional operation under these condition is not implied.*

**Table 4. Thermal data**

Symbol	Parameter	Value	Unit
$R_{thJC}$	Thermal resistance junction-case	81	°C/W
$R_{thJA}$	Thermal resistance junction-ambient	255	°C/W

## 5 Electrical characteristics

$T_J = 25\text{ }^\circ\text{C}$ ,  $V_{IN} = V_{OUT} + 0.5\text{ V}$ ;  $V_{OUT} = 1.6\text{ V}$ ;  $C_{IN} = C_{OUT} = 100\text{ nF}$ ;  $I_{OUT} = 1\text{ mA}$ ;  $V_{EN} = V_{IN}$ .

**Table 5. Electrical characteristics**

Symbol	Parameter	Test conditions	Min.	Typ.	Max.	Unit
$V_{IN}$	Operating input voltage range		1.8		5.5	V
$V_{OUT}^{(1)}$	Output voltage accuracy	$T_J = 25^\circ\text{C}$	-2.0		2.0	%
		$-40^\circ\text{C} < T_J < 125^\circ\text{C}$	-3.0		3.0	
$V_{REF}$	Reference voltage for adjustable version			0.8		V
	Reference accuracy for adjustable version	$-40^\circ\text{C} < T_J < 125^\circ\text{C}$	-3.0		3.0	%
	Adj. current	$0 < V_{ADJ} < 5.5\text{ V}$	-1		1	$\mu\text{A}$
$\frac{\Delta V_{OUT}\%}{\Delta V_{IN}}$	Static line regulation	$V_{OUT} + 0.5\text{ V} < V_{IN} < 5.5\text{ V}$ ; $T_J = 25^\circ\text{C}$		0.05		%/V
$\frac{\Delta V_{OUT}\%}{\Delta I_{OUT}}$	Static load regulation	$1\text{ mA} < I_{OUT} < 150\text{ mA}$ ; $T_J = 25^\circ\text{C}$		0.003		%/mA
$V_{DROP}$	Dropout voltage <sup>(2)</sup>	$V_{OUT} = 1.6\text{ V}$ ; $I_{OUT} = 100\text{ mA}$ ; $-40^\circ\text{C} < T_J < 125^\circ\text{C}$		50	100	mV
eN	Output noise voltage 10 Hz to 100k Hz; $I_O = 10\text{ mA}$	$V_{OUT} = 1\text{ V}$		40		$\mu\text{V}_{RMS}$
SVR	Supply voltage rejection	$V_{IN} = V_{OUT} + 1\text{ V} + V_{RIPPLE}$ $V_{RIPPLE-PP} = 0.5\text{ V}$ Freq.=1kHz; $I_{OUT} = 10\text{ mA}$		52		dB
		$V_{IN} = V_{OUT} + 1\text{ V} + V_{RIPPLE}$ $V_{RIPPLE-PP} = 0.5\text{ V}$ Freq.=10kHz; $I_{OUT} = 10\text{ mA}$		51		
$I_Q$	Quiescent current <sup>(2)</sup>	$0 < I_{OUT} < 150\text{ mA}$ ; $-40^\circ\text{C} < T_J < 125^\circ\text{C}$		120	160	$\mu\text{A}$
		Shutdown Mode			1	
$I_{SC}$	Short-circuit current <sup>(2)</sup>	$V_{OUT} = 0\text{ V}$	220			mA
$V_{EN}$	Enable Input logic low	$1.8\text{ V} < V_{IN} < 5.5\text{ V}$ ; $-40^\circ\text{C} < T_J < 125^\circ\text{C}$			0.3	V
	Enable input logic high		1.0			
$I_{EN}$	Enable pin input current	$V_{EN} = V_{IN}$ ; $1.8\text{ V} < V_{IN} < 5.5\text{ V}$		0.1	100	nA
$T_{ON}$	Turn-on time <sup>(3)</sup>	$V_{OUT} = 0.8\text{ V}$		300		$\mu\text{s}$
$T_{SHDN}$	Thermal shutdown			170		$^\circ\text{C}$
	Hysteresis			150		

1. Minimum  $V_{IN} = V_{OUT} + V_{DROP}$  or 1.8 V, whichever is greater.
2. Dropout voltage is the input-to-output voltage difference at which the output voltage is 100 mV below its nominal value; this specification does not apply for nominal output voltages below 1.6 V.
3. Turn-on time is the time measured between the enable input just exceeding  $V_{EN}$  high value and the output voltage just reaching 95% of its nominal value.

## 6 Typical performance characteristics

**Figure 5. Output voltage vs. temperature**  
( $V_{OUT} = 3.3\text{ V}$ ,  $I_{OUT} = 1\text{ mA}$ )

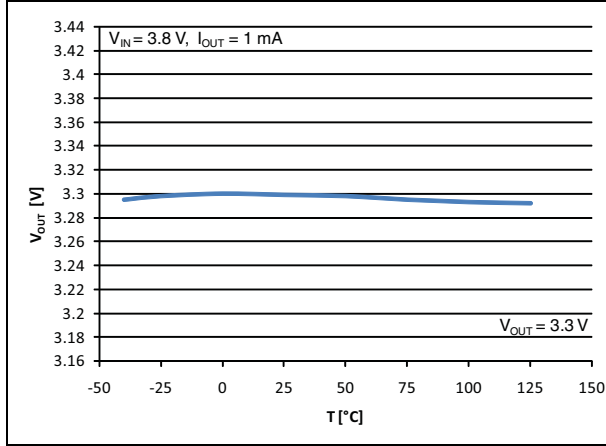

**Figure 6. Output voltage vs. temperature**  
( $V_{OUT} = 0.8\text{ V}$ ,  $I_{OUT} = 1\text{ mA}$ )

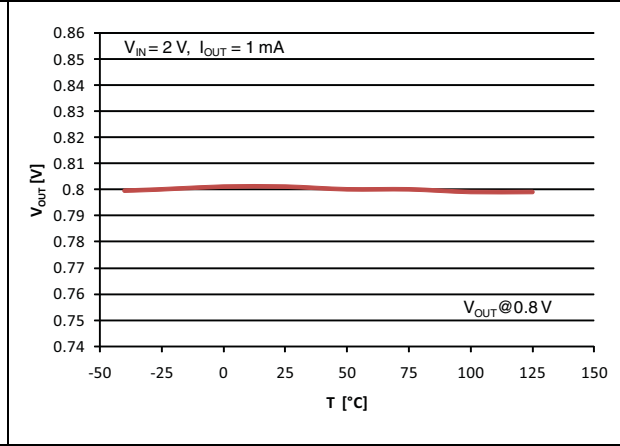

**Figure 7. Output voltage vs. temperature**  
( $V_{OUT} = 3.3\text{ V}$ ,  $I_{OUT} = 150\text{ mA}$ )

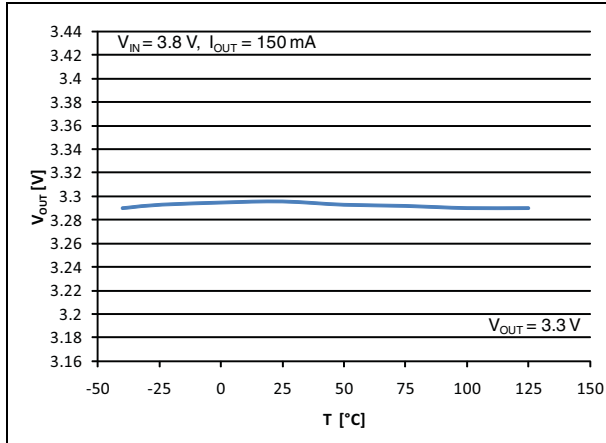

**Figure 8. Output voltage vs. temperature**  
( $V_{OUT} = 0.8\text{ V}$ ,  $I_{OUT} = 150\text{ mA}$ )

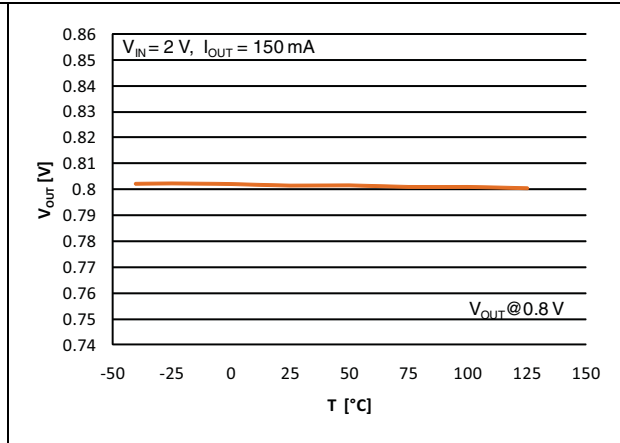

**Figure 9. Output voltage vs. input voltage**  
( $V_{OUT} = 0.8\text{ V}$ )

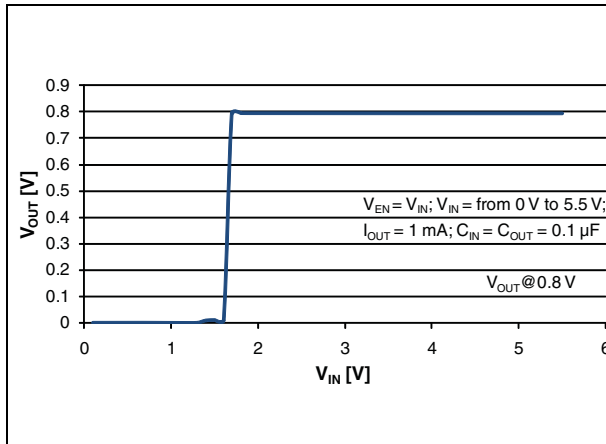

**Figure 10. Output voltage vs. input voltage**  
( $V_{OUT} = 3.3\text{ V}$ )

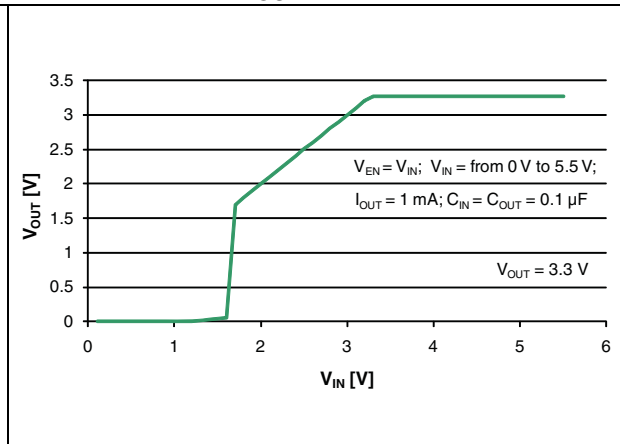

Figure 11. Dropout voltage vs. temperature

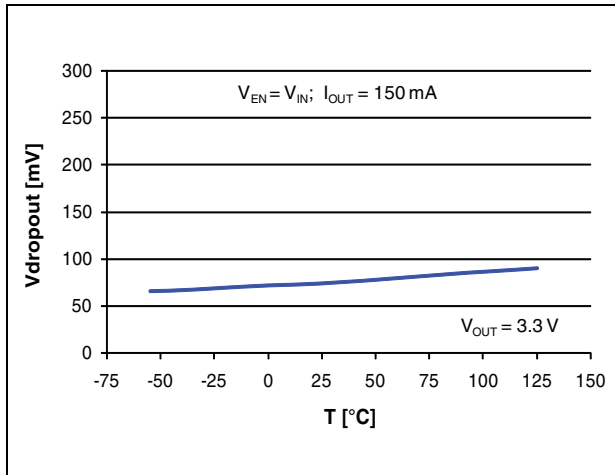

Figure 12. SVR vs. frequency (C<sub>OUT</sub> = 0.1 μF)

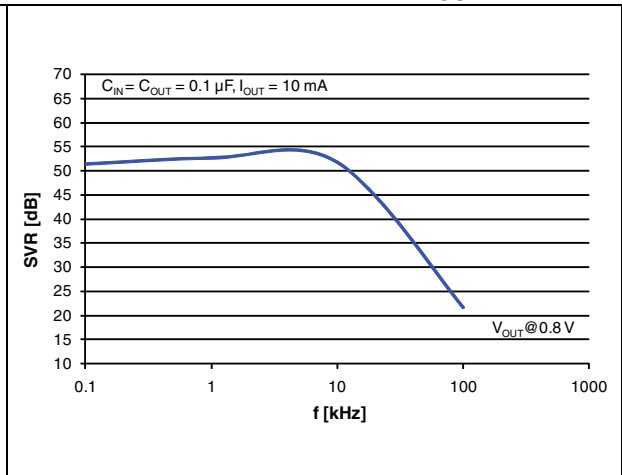

Figure 13. SVR vs. frequency, no C<sub>OUT</sub>

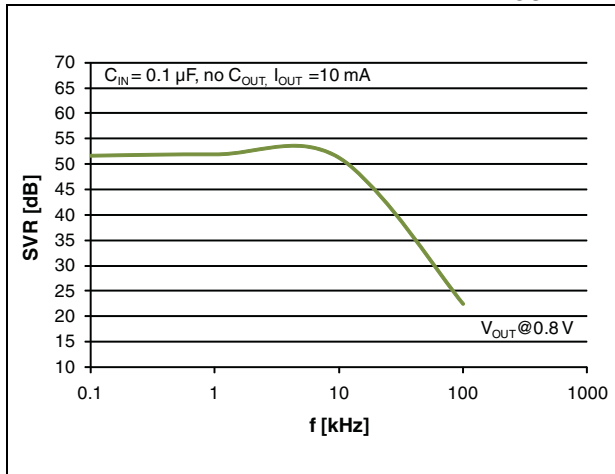

Figure 14. Noise voltage vs. C<sub>OUT</sub>

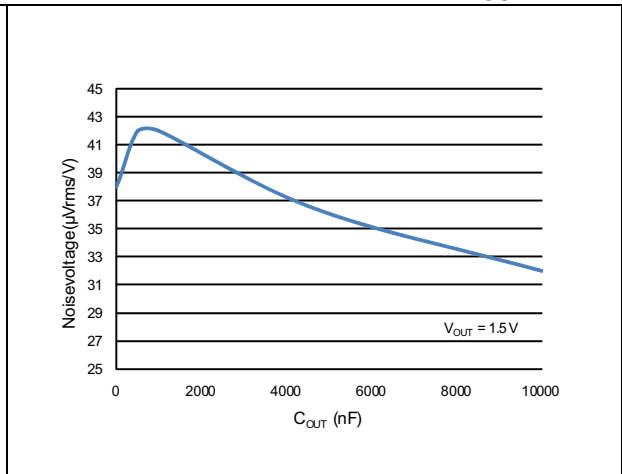
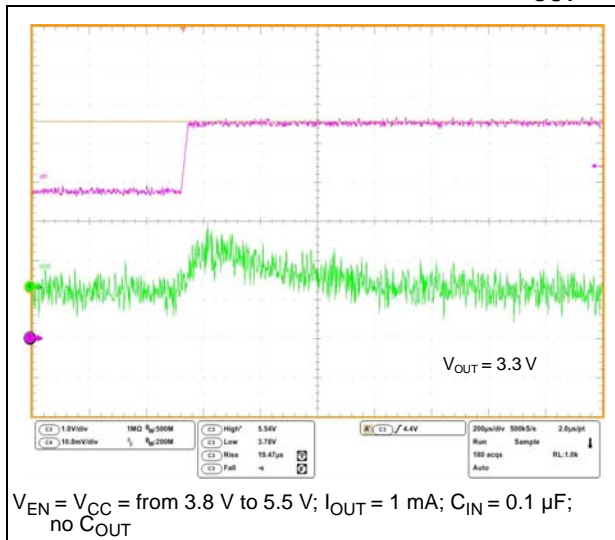
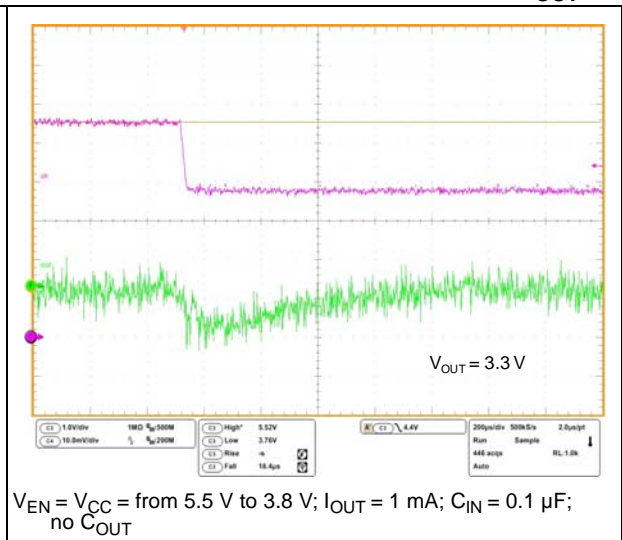

Figure 15. Line transient (rising), no C<sub>OUT</sub>



$V_{EN} = V_{CC} =$  from 3.8 V to 5.5 V;  $I_{OUT} = 1$  mA;  $C_{IN} = 0.1$  μF; no  $C_{OUT}$

Figure 16. Line transient (falling), no C<sub>OUT</sub>



$V_{EN} = V_{CC} =$  from 5.5 V to 3.8 V;  $I_{OUT} = 1$  mA;  $C_{IN} = 0.1$  μF; no  $C_{OUT}$

Figure 17. Line transient (rising),  $C_{OUT} = 1 \mu F$

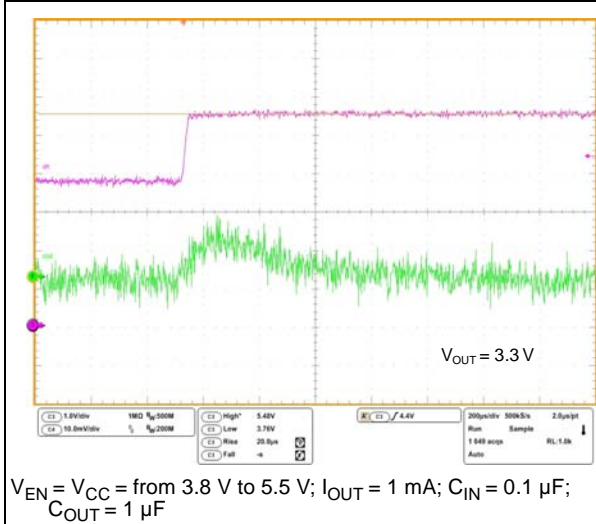

Figure 18. Line transient (falling),  $C_{OUT} = 1 \mu F$

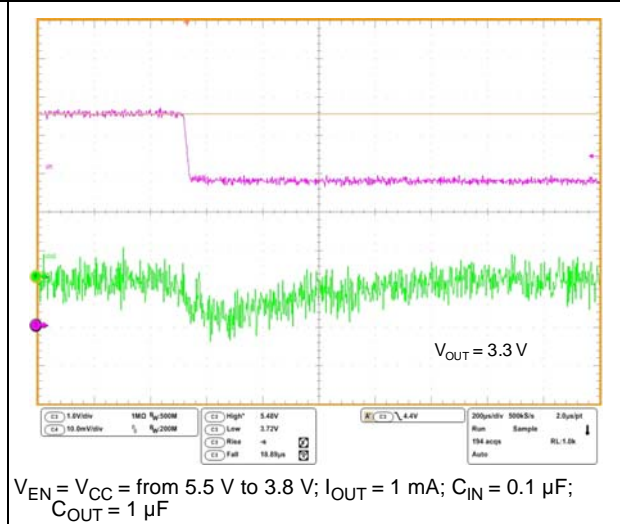

Figure 19. Load transient, no  $C_{OUT}$

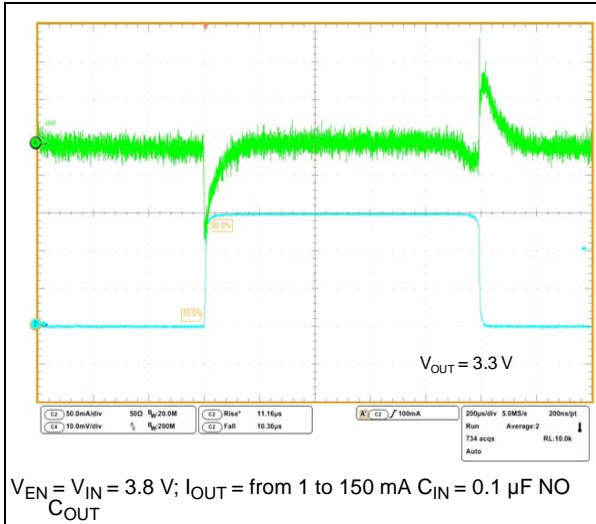
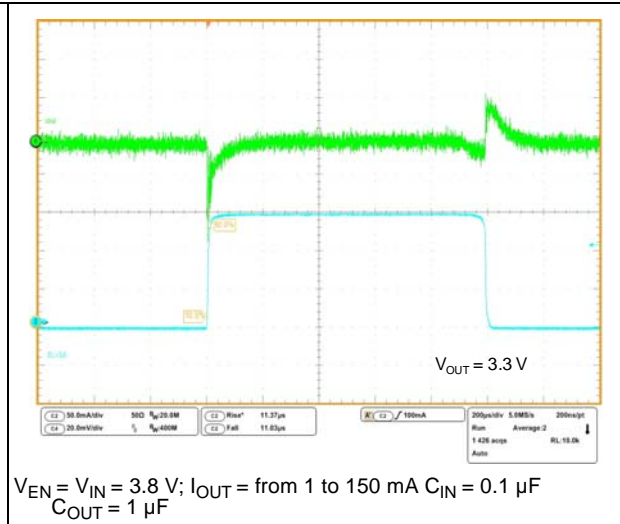

Figure 20. Load transient  $C_{OUT} = 1 \mu F$



## 7 Application information

### 7.1 General operation

The main feature of the LDCL015 is its capability to operate with or without input and output capacitors. To achieve this goal, the LDO architecture is based on a robust operational amplifier which has sufficient phase margin over all positions of the output capacitor pole.

The LDCL015 can operate with a 100 nF output capacitor, but also without an output capacitor, showing in both configurations good supply voltage rejection, stability and dynamic performance.

### 7.2 Thermal and short-circuit protection

The LDCL015 is self-protected from short-circuit condition and overtemperature. When the output load is higher than that supported by the device, the output current is increased until the limit of 220 mA (typ) is reached, at which point the current is kept constant even when the load impedance is zero.

Thermal protection acts when the junction temperature reaches 170 °C. At this point the IC is completely shut down. As soon as the junction temperature falls back below 150 °C, the device begins operating again.

To calculate the maximum power that the device can dissipate while keeping the junction temperature below the  $T_{J-OP}$ , the following formula is used:

#### Equation 1

$$P_{DMAX} = (125 - T_{AMB}) / R_{thJA}$$

### 7.3 Output voltage setting for ADJ version

In the adjustable version, the output voltage can be set from 0.8 V up to the input voltage, minus the voltage drop across the pass transistor (dropout voltage), by connecting a resistor divider between the ADJ pin and the output, thus allowing remote voltage sensing.

The resistor divider should be selected using the following equation:

#### Equation 2

$$V_{OUT} = V_{ADJ} (1 + R1 / R2), \text{ with } V_{ADJ} = 0.8 \text{ V (typ.)}$$

It is recommended to use resistors with values in the range of 10 kΩ to 50 kΩ. Lower values can also be suitable, but will increase current consumption.

### 7.4 Enable pin

The LDCL015 features an enable function. When the EN voltage is higher than 2 V, the device is ON; if it is lower than 0.8 V, the device is OFF.

In shutdown mode, the current consumption is lower than 1 μA.

The EN pin does not have an internal pull-up, which means that it cannot be left floating if it is not used.

## 8 Package mechanical data

In order to meet environmental requirements, ST offers these devices in different grades of ECOPACK<sup>®</sup> packages, depending on their level of environmental compliance. ECOPACK<sup>®</sup> specifications, grade definitions and product status are available at: [www.st.com](http://www.st.com). ECOPACK<sup>®</sup> is an ST trademark.

Figure 21. SOT23-5L mechanical drawing

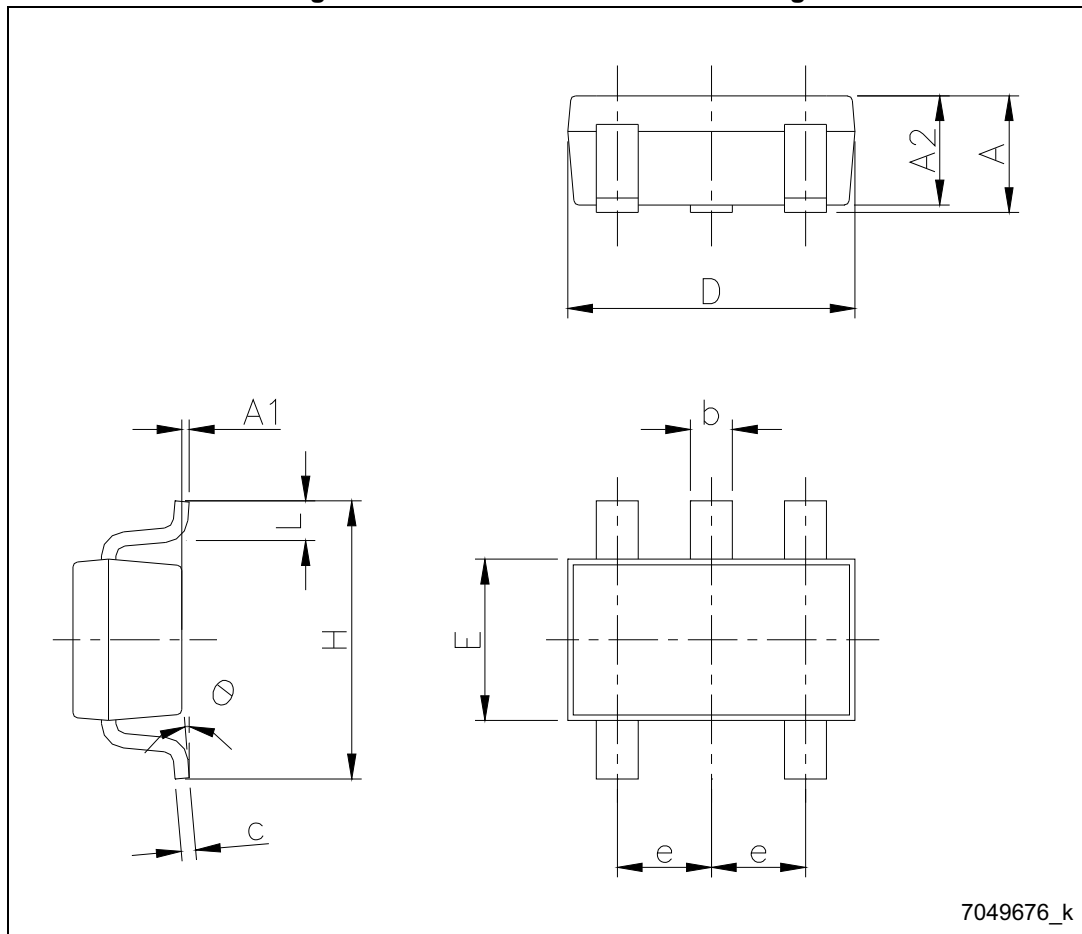
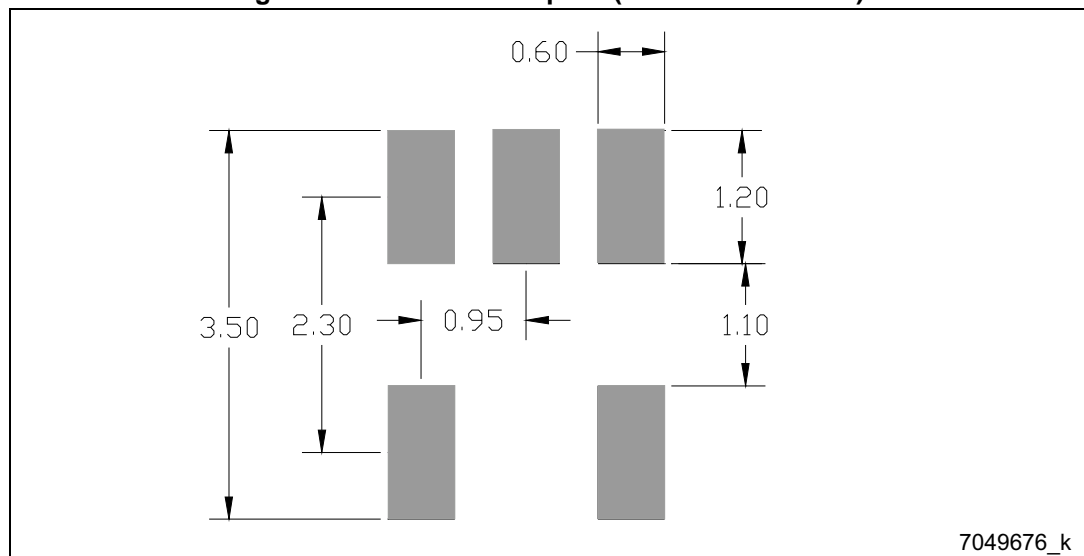

Table 6. SOT23-5L mechanical data

Dim.	mm		
	Min.	Typ.	Max.
A	0.90		1.45
A1	0		0.15
A2	0.90		1.30
b	0.30		0.50
c	2.09		0.20
D		2.95	
E		1.60	
e		0.95	
H		2.80	
L	0.30		0.60
$\theta$	0		8

Figure 22. SOT23-5L footprint (dimensions in mm)



# 9 Packaging mechanical data

Figure 23. SOT23-5L tape and reel drawing

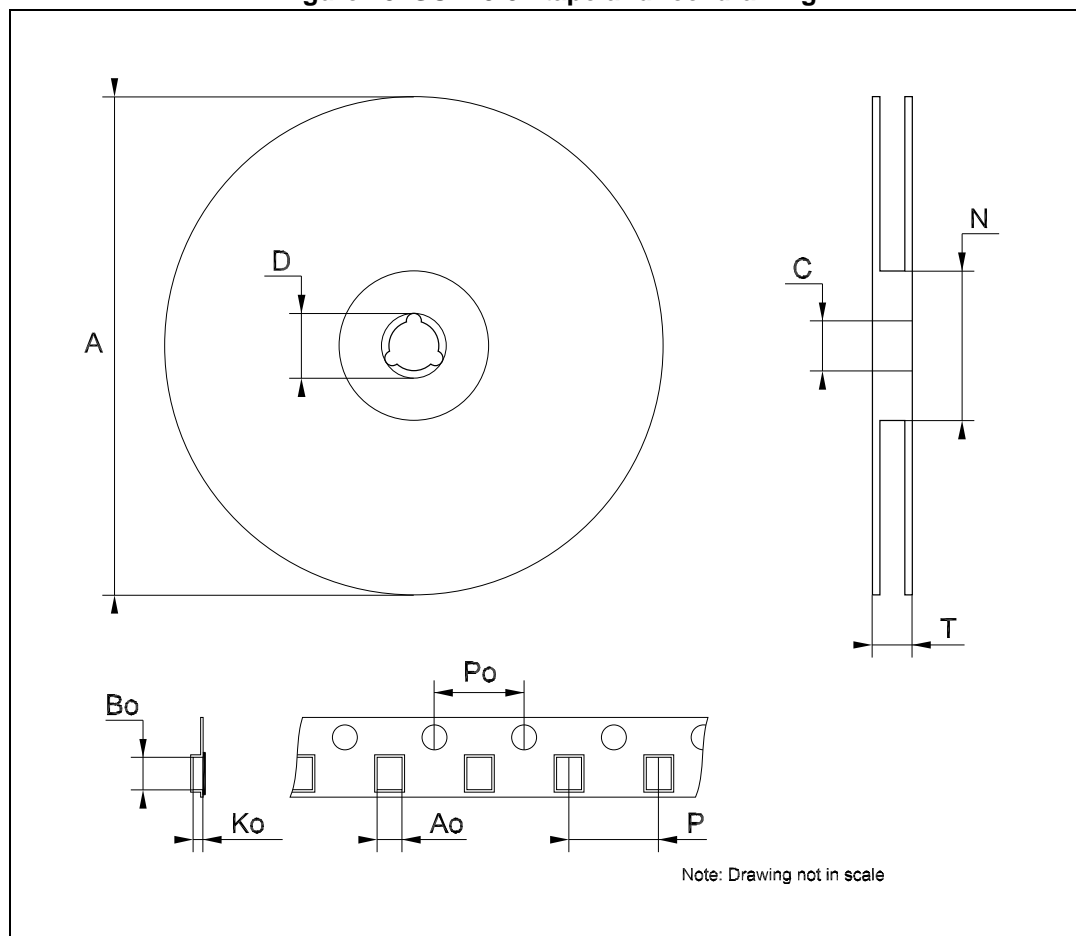

Table 7. SOT23-5L tape and reel mechanical data

Dim.	mm		
	Min.	Typ.	Max.
A			180
C	12.8	13.0	13.2
D	20.2		
N	60		
T			14.4
Ao	3.13	3.23	3.33
Bo	3.07	3.17	3.27
Ko	1.27	1.37	1.47
Po	3.9	4.0	4.1
P	3.9	4.0	4.1

## 10 Revision history

**Table 8. Document revision history**

Date	Revision	Changes
05-Sep-2011	1	First release.
15-Sep-2011	2	Added part number LDCL015XX to document heading and <a href="#">Table 1</a> . Modified document title. Removed Section 8: Other output voltage versions of the LDCL015 available on request.
09-May-2014	3	Part numbers LDCL015XX and LDCL015XX33 changed to LDCL015. Updated <a href="#">Section 6: Typical performance characteristics</a> and <a href="#">Section 8: Package mechanical data</a> . Added <a href="#">Section 9: Packaging mechanical data</a> . Minor text changes.

**Please Read Carefully:**

Information in this document is provided solely in connection with ST products. STMicroelectronics NV and its subsidiaries ("ST") reserve the right to make changes, corrections, modifications or improvements, to this document, and the products and services described herein at any time, without notice.

All ST products are sold pursuant to ST's terms and conditions of sale.

Purchasers are solely responsible for the choice, selection and use of the ST products and services described herein, and ST assumes no liability whatsoever relating to the choice, selection or use of the ST products and services described herein.

No license, express or implied, by estoppel or otherwise, to any intellectual property rights is granted under this document. If any part of this document refers to any third party products or services it shall not be deemed a license grant by ST for the use of such third party products or services, or any intellectual property contained therein or considered as a warranty covering the use in any manner whatsoever of such third party products or services or any intellectual property contained therein.

**UNLESS OTHERWISE SET FORTH IN ST'S TERMS AND CONDITIONS OF SALE ST DISCLAIMS ANY EXPRESS OR IMPLIED WARRANTY WITH RESPECT TO THE USE AND/OR SALE OF ST PRODUCTS INCLUDING WITHOUT LIMITATION IMPLIED WARRANTIES OF MERCHANTABILITY, FITNESS FOR A PARTICULAR PURPOSE (AND THEIR EQUIVALENTS UNDER THE LAWS OF ANY JURISDICTION), OR INFRINGEMENT OF ANY PATENT, COPYRIGHT OR OTHER INTELLECTUAL PROPERTY RIGHT.**

**ST PRODUCTS ARE NOT DESIGNED OR AUTHORIZED FOR USE IN: (A) SAFETY CRITICAL APPLICATIONS SUCH AS LIFE SUPPORTING, ACTIVE IMPLANTED DEVICES OR SYSTEMS WITH PRODUCT FUNCTIONAL SAFETY REQUIREMENTS; (B) AERONAUTIC APPLICATIONS; (C) AUTOMOTIVE APPLICATIONS OR ENVIRONMENTS, AND/OR (D) AEROSPACE APPLICATIONS OR ENVIRONMENTS. WHERE ST PRODUCTS ARE NOT DESIGNED FOR SUCH USE, THE PURCHASER SHALL USE PRODUCTS AT PURCHASER'S SOLE RISK, EVEN IF ST HAS BEEN INFORMED IN WRITING OF SUCH USAGE, UNLESS A PRODUCT IS EXPRESSLY DESIGNATED BY ST AS BEING INTENDED FOR "AUTOMOTIVE, AUTOMOTIVE SAFETY OR MEDICAL" INDUSTRY DOMAINS ACCORDING TO ST PRODUCT DESIGN SPECIFICATIONS. PRODUCTS FORMALLY ESCC, QML OR JAN QUALIFIED ARE DEEMED SUITABLE FOR USE IN AEROSPACE BY THE CORRESPONDING GOVERNMENTAL AGENCY.**

Resale of ST products with provisions different from the statements and/or technical features set forth in this document shall immediately void any warranty granted by ST for the ST product or service described herein and shall not create or extend in any manner whatsoever, any liability of ST.

ST and the ST logo are trademarks or registered trademarks of ST in various countries.

Information in this document supersedes and replaces all information previously supplied.

The ST logo is a registered trademark of STMicroelectronics. All other names are the property of their respective owners.

© 2014 STMicroelectronics - All rights reserved

STMicroelectronics group of companies

Australia - Belgium - Brazil - Canada - China - Czech Republic - Finland - France - Germany - Hong Kong - India - Israel - Italy - Japan - Malaysia - Malta - Morocco - Philippines - Singapore - Spain - Sweden - Switzerland - United Kingdom - United States of America

[www.st.com](http://www.st.com)



# AMEYA360

## Components Supply Platform

### Authorized Distribution Brand :



### Website :

Welcome to visit [www.ameya360.com](http://www.ameya360.com)

### Contact Us :

#### ➤ Address :

401 Building No.5, JiuGe Business Center, Lane 2301, Yishan Rd  
Minhang District, Shanghai , China

#### ➤ Sales :

Direct +86 (21) 6401-6692

Email [amall@ameya360.com](mailto:amall@ameya360.com)

QQ 800077892

Skype [ameyasales1](#) [ameyasales2](#)

#### ➤ Customer Service :

Email [service@ameya360.com](mailto:service@ameya360.com)

#### ➤ Partnership :

Tel +86 (21) 64016692-8333

Email [mkt@ameya360.com](mailto:mkt@ameya360.com)