

BSS123LT1G, BVSS123LT1G

Power MOSFET 170 mAmps, 100 Volts

N-Channel SOT-23

Features

- BVSS Prefix for Automotive and Other Applications Requiring Unique Site and Control Change Requirements; AEC-Q101 Qualified and PPAP Capable
- These Devices are Pb-Free and are RoHS Compliant

MAXIMUM RATINGS

Rating	Symbol	Value	Unit
Drain-Source Voltage	V_{DSS}	100	Vdc
Gate-Source Voltage	V_{GS}	± 20	Vdc
- Continuous	V_{GS}	± 40	Vpk
- Non-repetitive ($t_p \leq 50 \mu s$)	V_{GSM}		
Drain Current	I_D	0.17	Adc
- Continuous (Note 1)	I_{DM}	0.68	
- Pulsed (Note 2)			

Stresses exceeding those listed in the Maximum Ratings table may damage the device. If any of these limits are exceeded, device functionality should not be assumed, damage may occur and reliability may be affected.

THERMAL CHARACTERISTICS

Characteristic	Symbol	Max	Unit
Total Device Dissipation FR-5 Board (Note 3) $T_A = 25^\circ C$ Derate above $25^\circ C$	P_D	225 1.8	mW mW/ $^\circ C$
Thermal Resistance, Junction-to-Ambient	$R_{\theta JA}$	556	$^\circ C/W$
Junction and Storage Temperature	T_J, T_{stg}	-55 to +150	$^\circ C$

1. The Power Dissipation of the package may result in a lower continuous drain current.
2. Pulse Width $\leq 300 \mu s$, Duty Cycle $\leq 2.0\%$.
3. FR-5 = $1.0 \times 0.75 \times 0.062$ in.



ON Semiconductor®

<http://onsemi.com>

170 mAmps

100 Volts

$R_{DS(on)} = 6 \Omega$

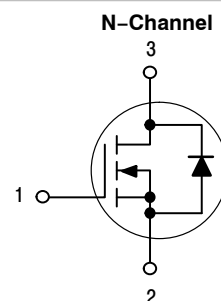

MARKING DIAGRAM & PIN ASSIGNMENT

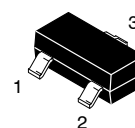

SOT-23
CASE 318
STYLE 21

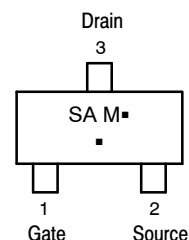

SA = Device Code
M = Date Code
▪ = Pb-Free Package

(*Note: Microdot may be in either location)

*Date Code orientation and/or position may vary depending upon manufacturing location.

ORDERING INFORMATION

See detailed ordering and shipping information in the package dimensions section on page 2 of this data sheet.

BSS123LT1G, BVSS123LT1G

ELECTRICAL CHARACTERISTICS ($T_A = 25^\circ\text{C}$ unless otherwise noted)

Characteristic	Symbol	Min	Typ	Max	Unit
OFF CHARACTERISTICS					
Drain-Source Breakdown Voltage ($V_{GS} = 0, I_D = 250 \mu\text{Adc}$)	$V_{(BR)DSS}$	100	-	-	Vdc
Zero Gate Voltage Drain Current ($V_{GS} = 0, V_{DS} = 100 \text{Vdc}$) $T_J = 25^\circ\text{C}$ $T_J = 125^\circ\text{C}$	I_{DSS}	-	-	15 60	μAdc
Gate-Body Leakage Current ($V_{GS} = 20 \text{Vdc}, V_{DS} = 0$)	I_{GSS}	-	-	50	nAdc

ON CHARACTERISTICS (Note 4)

Gate Threshold Voltage ($V_{DS} = V_{GS}, I_D = 1.0 \text{mAdc}$)	$V_{GS(th)}$	1.6	-	2.6	Vdc
Static Drain-Source On-Resistance ($V_{GS} = 10 \text{Vdc}, I_D = 100 \text{mAdc}$)	$r_{DS(on)}$	-	-	6.0	Ω
Forward Transconductance ($V_{DS} = 25 \text{Vdc}, I_D = 100 \text{mAdc}$)	g_{fs}	80	-	-	mmhos

DYNAMIC CHARACTERISTICS

Input Capacitance ($V_{DS} = 25 \text{Vdc}, V_{GS} = 0, f = 1.0 \text{MHz}$)	C_{iss}	-	20	-	pF
Output Capacitance ($V_{DS} = 25 \text{Vdc}, V_{GS} = 0, f = 1.0 \text{MHz}$)	C_{oss}	-	9.0	-	pF
Reverse Transfer Capacitance ($V_{DS} = 25 \text{Vdc}, V_{GS} = 0, f = 1.0 \text{MHz}$)	C_{rss}	-	4.0	-	pF

SWITCHING CHARACTERISTICS⁽⁴⁾

Turn-On Delay Time	$(V_{CC} = 30 \text{Vdc}, I_C = 0.28 \text{Adc},$ $V_{GS} = 10 \text{Vdc}, R_{GS} = 50 \Omega)$	$t_{d(on)}$	-	20	-	ns
Turn-Off Delay Time		$t_{d(off)}$	-	40	-	ns

REVERSE DIODE

Diode Forward On-Voltage ($I_D = 0.34 \text{Adc}, V_{GS} = 0 \text{Vdc}$)	V_{SD}	-	-	1.3	V
--	----------	---	---	-----	---

Product parametric performance is indicated in the Electrical Characteristics for the listed test conditions, unless otherwise noted. Product performance may not be indicated by the Electrical Characteristics if operated under different conditions.

4. Pulse Test: Pulse Width $\leq 300 \mu\text{s}$, Duty Cycle $\leq 2.0\%$.

ORDERING INFORMATION

Device	Package	Shipping [†]
BSS123LT1G	SOT-23 (Pb-Free)	3000 / Tape & Reel
BSS123LT3G	SOT-23 (Pb-Free)	10000 / Tape & Reel
BVSS123LT1G*	SOT-23 (Pb-Free)	3000 / Tape & Reel

[†]For information on tape and reel specifications, including part orientation and tape sizes, please refer to our Tape and Reel Packaging Specifications Brochure, BRD8011/D.

*BVSS Prefix for Automotive and Other Applications Requiring Unique Site and Control Change Requirements; AEC-Q101 Qualified and PPAP Capable.

BSS123LT1G, BVSS123LT1G

TYPICAL ELECTRICAL CHARACTERISTICS

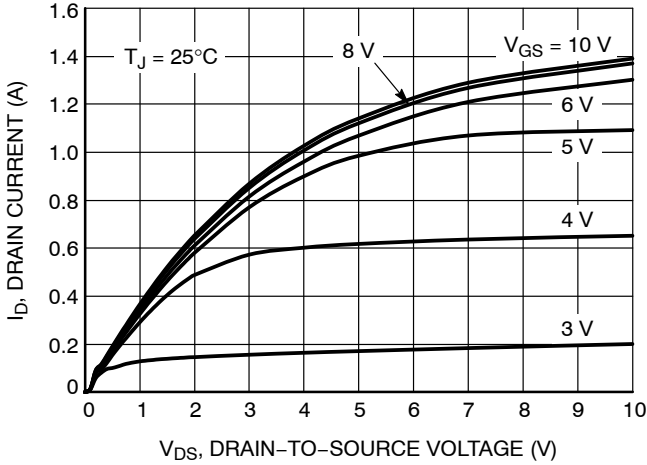

Figure 1. On-Region Characteristics

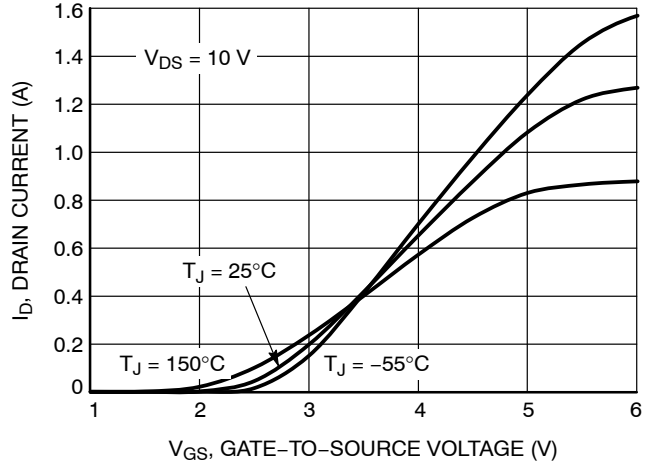

Figure 2. Transfer Characteristics

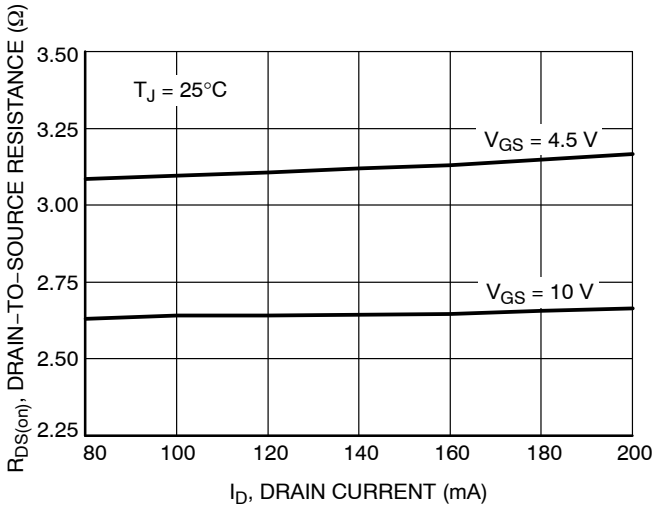

Figure 3. On-Resistance vs. Drain Current and Gate Voltage

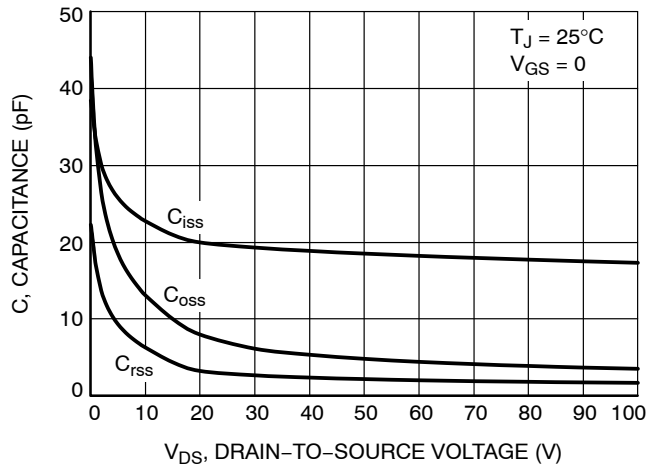

Figure 4. Capacitance Variation

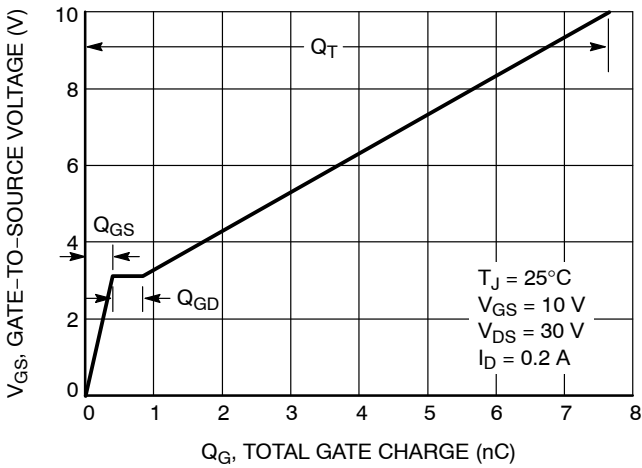

Figure 5. Gate-to-Source and Drain-to-Source Voltage vs. Total Charge

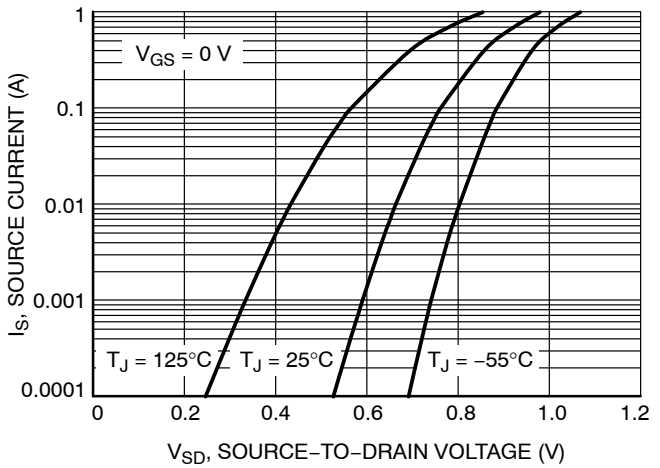

Figure 6. Diode Forward Voltage vs. Current

BSS123LT1G, BVSS123LT1G

TYPICAL ELECTRICAL CHARACTERISTICS

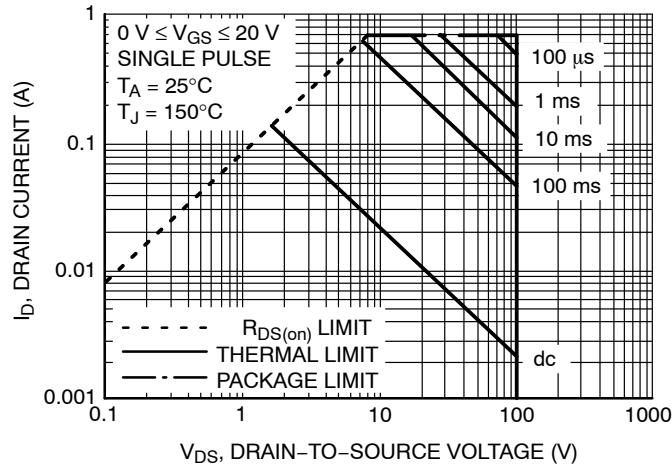

Figure 7. Maximum Rated Forward Biased Safe Operating Area

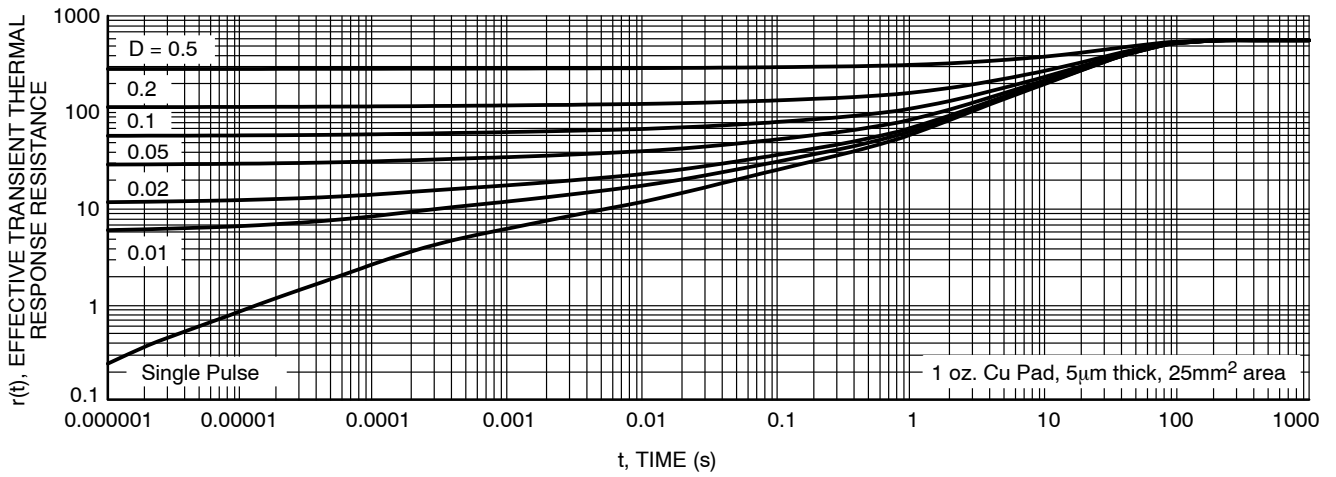
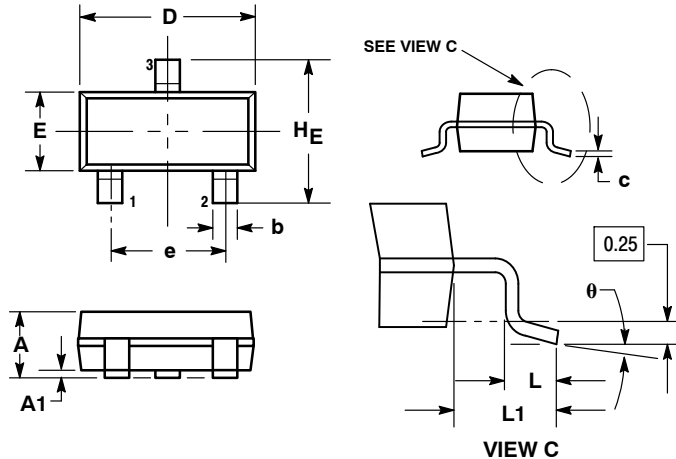

Figure 8. Thermal Response

BSS123LT1G, BVSS123LT1G

PACKAGE DIMENSIONS

SOT-23 (TO-236)
CASE 318-08
ISSUE AP



- NOTES:
1. DIMENSIONING AND TOLERANCING PER ANSI Y14.5M, 1982.
 2. CONTROLLING DIMENSION: INCH.
 3. MAXIMUM LEAD THICKNESS INCLUDES LEAD FINISH THICKNESS. MINIMUM LEAD THICKNESS IS THE MINIMUM THICKNESS OF BASE MATERIAL.
 4. DIMENSIONS D AND E DO NOT INCLUDE MOLD FLASH, PROTRUSIONS, OR GATE BURRS.

DIM	MILLIMETERS			INCHES		
	MIN	NOM	MAX	MIN	NOM	MAX
A	0.89	1.00	1.11	0.035	0.040	0.044
A1	0.01	0.06	0.10	0.001	0.002	0.004
b	0.37	0.44	0.50	0.015	0.018	0.020
c	0.09	0.13	0.18	0.003	0.005	0.007
D	2.80	2.90	3.04	0.110	0.114	0.120
E	1.20	1.30	1.40	0.047	0.051	0.055
e	1.78	1.90	2.04	0.070	0.075	0.081
L	0.10	0.20	0.30	0.004	0.008	0.012
L1	0.35	0.54	0.69	0.014	0.021	0.029
HE	2.10	2.40	2.64	0.083	0.094	0.104
θ	0°	---	10°	0°	---	10°

STYLE 21:
PIN 1. GATE
2. SOURCE
3. DRAIN

SOLDERING FOOTPRINT*

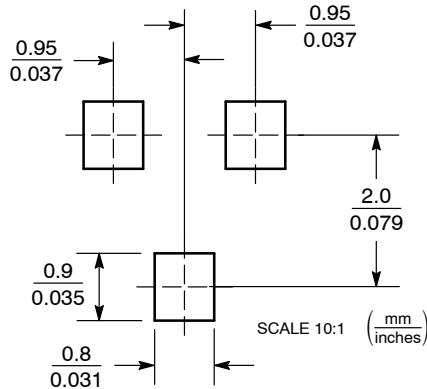

*For additional information on our Pb-Free strategy and soldering details, please download the ON Semiconductor Soldering and Mounting Techniques Reference Manual, SOLDERRM/D.

ON Semiconductor and are registered trademarks of Semiconductor Components Industries, LLC (SCILLC). SCILLC owns the rights to a number of patents, trademarks, copyrights, trade secrets, and other intellectual property. A listing of SCILLC's product/patent coverage may be accessed at www.onsemi.com/site/pdf/Patent-Marking.pdf. SCILLC reserves the right to make changes without further notice to any products herein. SCILLC makes no warranty, representation or guarantee regarding the suitability of its products for any particular purpose, nor does SCILLC assume any liability arising out of the application or use of any product or circuit, and specifically disclaims any and all liability, including without limitation special, consequential or incidental damages. "Typical" parameters which may be provided in SCILLC data sheets and/or specifications can and do vary in different applications and actual performance may vary over time. All operating parameters, including "Typicals" must be validated for each customer application by customer's technical experts. SCILLC does not convey any license under its patent rights nor the rights of others. SCILLC products are not designed, intended, or authorized for use as components in systems intended for surgical implant into the body, or other applications intended to support or sustain life, or for any other application in which the failure of the SCILLC product could create a situation where personal injury or death may occur. Should Buyer purchase or use SCILLC products for any such unintended or unauthorized application, Buyer shall indemnify and hold SCILLC and its officers, employees, subsidiaries, affiliates, and distributors harmless against all claims, costs, damages, and expenses, and reasonable attorney fees arising out of, directly or indirectly, any claim of personal injury or death associated with such unintended or unauthorized use, even if such claim alleges that SCILLC was negligent regarding the design or manufacture of the part. SCILLC is an Equal Opportunity/Affirmative Action Employer. This literature is subject to all applicable copyright laws and is not for resale in any manner.

PUBLICATION ORDERING INFORMATION

LITERATURE FULFILLMENT:

Literature Distribution Center for ON Semiconductor
P.O. Box 5163, Denver, Colorado 80217 USA
Phone: 303-675-2175 or 800-344-3860 Toll Free USA/Canada
Fax: 303-675-2176 or 800-344-3867 Toll Free USA/Canada
Email: orderlit@onsemi.com

N. American Technical Support: 800-282-9855 Toll Free
USA/Canada
Europe, Middle East and Africa Technical Support:
Phone: 421 33 790 2910
Japan Customer Focus Center
Phone: 81-3-5817-1050

ON Semiconductor Website: www.onsemi.com

Order Literature: <http://www.onsemi.com/orderlit>

For additional information, please contact your local Sales Representative

AMEYA360

Components Supply Platform

Authorized Distribution Brand :



Website :

Welcome to visit www.ameya360.com

Contact Us :

➤ Address :

401 Building No.5, JiuGe Business Center, Lane 2301, Yishan Rd
Minhang District, Shanghai , China

➤ Sales :

Direct +86 (21) 6401-6692

Email amall@ameya360.com

QQ 800077892

Skype [ameyasales1](#) [ameyasales2](#)

➤ Customer Service :

Email service@ameya360.com

➤ Partnership :

Tel +86 (21) 64016692-8333

Email mkt@ameya360.com