

LMV341-N/LMV342-N/LMV344-N Single with Shutdown/Dual/Quad General Purpose, 2.7V, Rail-to-Rail Output, 125°C, Operational Amplifiers

Check for Samples: [LMV341-N](#), [LMV342-N](#), [LMV344-N](#)

FEATURES

(Typical 2.7V Supply Values; Unless Otherwise Noted)

- **Ensured 2.7V and 5V Specifications**
- **Input Referred Voltage Noise (@ 10kHz) 29nV/√Hz**
- **Supply Current (per Amplifier) 100μA**
- **Gain Bandwidth Product 1.0MHz**
- **Slew Rate 1.0V/μs**
- **Shutdown Current (LMV341-N) 45pA**
- **Turn-On Time from Shutdown (LMV341-N) 5μs**
- **Input Bias Current 20fA**

APPLICATIONS

- **Cordless/Cellular Phones**
- **Laptops**
- **PDA's**
- **PCMCIA/Audio**
- **Portable/Battery-Powered Electronic Equipment**
- **Supply Current Monitoring**
- **Battery Monitoring**
- **Buffer**
- **Filter**
- **Driver**

DESCRIPTION

The LMV341-N/LMV342-N/LMV344-N are single, dual, and quad low voltage, low power Operational Amplifiers. They are designed specifically for low voltage portable applications. Other important product characteristics are low input bias current, rail-to-rail output, and wide temperature range.

The patented class AB turnaround stage significantly reduces the noise at higher frequencies, power consumption, and offset voltage. The PMOS input stage provides the user with ultra-low input bias current of 20fA (typical) and high input impedance.

The industrial-plus temperature range of -40°C to 125°C allows the LMV341-N/LMV342-N/LMV344-N to accommodate a broad range of extended environment applications. LMV341-N expands Texas Instrument's Silicon Dust amplifier portfolio offering enhancements in size, speed, and power savings. The LMV341-N/LMV342-N/LMV344-N are specified to operate over the voltage range of 2.7V to 5.5V and all have rail-to-rail output.

The LMV341-N offers a shutdown pin that can be used to disable the device. Once in shutdown mode, the supply current is reduced to 45pA (typical). The LMV341-N/LMV342-N/LMV344-N have 29nV Voltage Noise at 10KHz, 1MHz GBW, 1.0V/μs Slew Rate, 0.25mVos, and 0.1μA shutdown current (LMV341-N.)

The LMV341-N is offered in the tiny 6-Pin SC70 package, the LMV342-N in space saving 8-Pin VSSOP and SOIC, and the LMV344-N in 14-Pin TSSOP and SOIC. These small package amplifiers offer an ideal solution for applications requiring minimum PC board footprint. Applications with area constrained PC board requirements include portable electronics such as cellular handsets and PDA's.

Sample and Hold Circuit

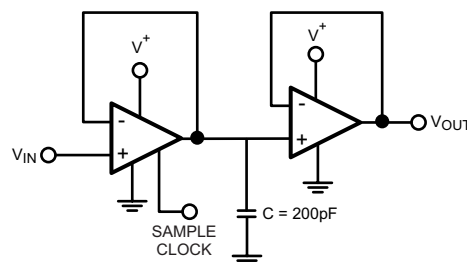

Please be aware that an important notice concerning availability, standard warranty, and use in critical applications of Texas Instruments semiconductor products and disclaimers thereto appears at the end of this data sheet.

All trademarks are the property of their respective owners.



These devices have limited built-in ESD protection. The leads should be shorted together or the device placed in conductive foam during storage or handling to prevent electrostatic damage to the MOS gates.

Absolute Maximum Ratings⁽¹⁾⁽²⁾

ESD Tolerance ⁽³⁾	Machine Model	200V
	Human Body Model	2000V
Differential Input Voltage		± Supply Voltage
Supply Voltage (V ⁺ -V ⁻)		6.0V
Output Short Circuit to V ⁺		See ⁽⁴⁾
Output Short Circuit to V ⁻		See ⁽⁵⁾
Storage Temperature Range		-65°C to 150°C
Junction Temperature ⁽⁶⁾		150°C
Mounting Temperature	Infrared or Convection Reflow (20 sec.)	235°C
	Wave Soldering Lead Temperature (10 sec.)	260°C

- (1) Absolute Maximum Ratings indicate limits beyond which damage to the device may occur. Operating Ratings indicate conditions for which the device is intended to be functional, but specific performance is not ensured. For ensured specifications and the test conditions, see the Electrical Characteristics.
- (2) If Military/Aerospace specified devices are required, please contact the Texas Instruments Sales Office/Distributors for availability and specifications.
- (3) Human Body Model, applicable std. MIL-STD-883, Method 3015.7. Machine Model, applicable std. JESD22-A115-A (ESD MM std. of JEDEC)Field-Induced Charge-Device Model, applicable std. JESD22-C101-C (ESD FICDM std. of JEDEC).
- (4) Shorting output to V⁺ will adversely affect reliability.
- (5) Shorting output to V⁻ will adversely affect reliability.
- (6) The maximum power dissipation is a function of T_{J(MAX)}, θ_{JA}. The maximum allowable power dissipation at any ambient temperature is P_D = (T_{J(MAX)} - T_A) / θ_{JA}. All numbers apply for packages soldered directly onto a PC Board.

Operating Ratings⁽¹⁾

Supply Voltage		2.7V to 5.5V
Temperature Range		-40°C to 125°C
Thermal Resistance (θ _{JA})	6-Pin SC70	414°C/W
	8-Pin SOIC	190°C/W
	8-Pin VSSOP	235°C/W
	14-Pin TSSOP	155°C/W
	14-Pin SOIC	145°C/W

- (1) Absolute Maximum Ratings indicate limits beyond which damage to the device may occur. Operating Ratings indicate conditions for which the device is intended to be functional, but specific performance is not ensured. For ensured specifications and the test conditions, see the Electrical Characteristics.

2.7V DC Electrical Characteristics⁽¹⁾

Unless otherwise specified, all limits specified for $T_J = 25^\circ\text{C}$, $V^+ = 2.7\text{V}$, $V^- = 0\text{V}$, $V_{\text{CM}} = V^+/2$, $V_O = V^+/2$ and $R_L > 1\text{M}\Omega$.

Boldface limits apply at the temperature extremes.

Symbol	Parameter	Conditions	Min ⁽²⁾	Typ ⁽³⁾	Max ⁽²⁾	Units
V_{OS}	Input Offset Voltage	LMV341-N		0.25	4 4.5	mV
		LMV342-N/LMV344-N		0.55	5 5.5	
TCV_{OS}	Input Offset Voltage Average Drift			1.7		$\mu\text{V}/^\circ\text{C}$
I_B	Input Bias Current			0.02	120 250	pA
I_{OS}	Input Offset Current			6.6		fA
I_S	Supply Current	Per Amplifier		100	170 230	μA
		Shutdown Mode, $V_{\text{SD}} = 0\text{V}$ (LMV341-N)		45pA	1 μA 1.5μA	
CMRR	Common Mode Rejection Ratio	$0\text{V} \leq V_{\text{CM}} \leq 1.7\text{V}$ $0\text{V} \leq V_{\text{CM}} \leq 1.6\text{V}$	56 50	80		dB
PSRR	Power Supply Rejection Ratio	$2.7\text{V} \leq V^+ \leq 5\text{V}$	65 60	82		dB
V_{CM}	Input Common Mode Voltage	For CMRR $\geq 50\text{dB}$	0	-0.2 to 1.9 (Range)	1.7	V
A_V	Large Signal Voltage Gain	$R_L = 10\text{k}\Omega$ to 1.35V	78 70	113		dB
		$R_L = 2\text{k}\Omega$ to 1.35V	72 64	103		
V_O	Output Swing	$R_L = 2\text{k}\Omega$ to 1.35V		24	60 95	mV
				60 95	26	
		$R_L = 10\text{k}\Omega$ to 1.35V		5.0	30 40	
				30 40	5.3	
I_O	Output Short Circuit Current	Sourcing LMV341-N/LMV342-N	20	32		mA
		Sourcing LMV344-N	18	24		
		Sinking	15	24		
t_{on}	Turn-on Time from Shutdown	(LMV341-N)		5		μs
V_{SD}	Shutdown Pin Voltage Range	ON Mode (LMV341-N)		1.7 to 2.7	2.4 to 2.7	V
		Shutdown Mode (LMV341-N)		0 to 1	0 to 0.8	

(1) Electrical Table values apply only for factory testing conditions at the temperature indicated. Factory testing conditions result in very limited self-heating of the device such that $T_J = T_A$. No specification of parametric performance is indicated in the electrical tables under conditions of internal self heating where $T_J > T_A$.

(2) All limits are specified by testing or statistical analysis.

(3) Typical values represent the most likely parametric norm as determined at the time of characterization. Actual typical values may vary over time and will also depend on the application and configuration. The typical values are not tested and are not ensured on shipped production material.

2.7V AC Electrical Characteristics⁽¹⁾

Unless otherwise specified, all limits specified for $T_J = 25^\circ\text{C}$, $V^+ = 2.7\text{V}$, $V^- = 0\text{V}$, $V_{\text{CM}} = V^+/2$, $V_O = V^+/2$ and $R_L > 1\text{M}\Omega$.

Boldface limits apply at the temperature extremes.

Symbol	Parameter	Conditions	Min ⁽²⁾	Typ ⁽³⁾	Max ⁽²⁾	Units
SR	Slew Rate	$R_L = 10\text{k}\Omega$ ⁽⁴⁾		1.0		V/ μs
GBW	Gain Bandwidth Product	$R_L = 100\text{k}\Omega$, $C_L = 200\text{pF}$		1.0		MHz
Φ_m	Phase Margin	$R_L = 100\text{k}\Omega$		72		deg
G_m	Gain Margin	$R_L = 100\text{k}\Omega$		20		dB
e_n	Input-Referred Voltage Noise	$f = 1\text{kHz}$		40		nV/ $\sqrt{\text{Hz}}$
i_n	Input-Referred Current Noise	$f = 1\text{kHz}$		0.001		pA/ $\sqrt{\text{Hz}}$
THD	Total Harmonic Distortion	$f = 1\text{kHz}$, $A_V = +1$ $R_L = 600\Omega$, $V_{\text{IN}} = 1\text{V}_{\text{PP}}$		0.017		%

- (1) Electrical Table values apply only for factory testing conditions at the temperature indicated. Factory testing conditions result in very limited self-heating of the device such that $T_J = T_A$. No specification of parametric performance is indicated in the electrical tables under conditions of internal self heating where $T_J > T_A$.
- (2) All limits are specified by testing or statistical analysis.
- (3) Typical values represent the most likely parametric norm as determined at the time of characterization. Actual typical values may vary over time and will also depend on the application and configuration. The typical values are not tested and are not ensured on shipped production material.
- (4) Connected as voltage follower with 2V_{PP} step input. Number specified is the slower of the positive and negative slew rates.

5V DC Electrical Characteristics⁽¹⁾

Unless otherwise specified, all limits specified for $T_J = 25^\circ\text{C}$, $V^+ = 5\text{V}$, $V^- = 0\text{V}$, $V_{\text{CM}} = V^+/2$, $V_O = V^+/2$ and $R_L > 1\text{M}\Omega$.

Boldface limits apply at the temperature extremes.

Symbol	Parameter	Conditions	Min ⁽²⁾	Typ ⁽³⁾	Max ⁽²⁾	Units
V_{OS}	Input Offset Voltage	LMV341-N		0.025	4 4.5	mV
		LMV342-N/LMV344-N		0.70	5 5.5	
TCV_{OS}	Input Offset Voltage Average Drift			1.9		$\mu\text{V}/^\circ\text{C}$
I_B	Input Bias Current			0.02	200 375	pA
I_{OS}	Input Offset Current			6.6		fA
I_S	Supply Current	Per Amplifier		107	200 260	μA
		Shutdown Mode, $V_{\text{SD}} = 0\text{V}$ (LMV341-N)		0.033	1 1.5	μA
CMRR	Common Mode Rejection Ratio	$0\text{V} \leq V_{\text{CM}} \leq 4.0\text{V}$ $0\text{V} \leq V_{\text{CM}} \leq 3.9\text{V}$	56 50	86		dB
PSRR	Power Supply Rejection Ratio	$2.7\text{V} \leq V^+ \leq 5\text{V}$	65 60	82		dB
V_{CM}	Input Common Mode Voltage	For CMRR $\geq 50\text{dB}$	0	-0.2 to 4.2 (Range)	4	V
A_V	Large Signal Voltage Gain ⁽⁴⁾	$R_L = 10\text{k}\Omega$ to 2.5V	78 70	116		dB
		$R_L = 2\text{k}\Omega$ to 2.5V	72 64	107		

- (1) Electrical Table values apply only for factory testing conditions at the temperature indicated. Factory testing conditions result in very limited self-heating of the device such that $T_J = T_A$. No specification of parametric performance is indicated in the electrical tables under conditions of internal self heating where $T_J > T_A$.
- (2) All limits are specified by testing or statistical analysis.
- (3) Typical values represent the most likely parametric norm as determined at the time of characterization. Actual typical values may vary over time and will also depend on the application and configuration. The typical values are not tested and are not ensured on shipped production material.
- (4) R_L is connected to mid-supply. The output voltage is $\text{GND} + 0.2\text{V} \leq V_O \leq V^+ - 0.2\text{V}$

5V DC Electrical Characteristics⁽¹⁾ (continued)

 Unless otherwise specified, all limits specified for $T_J = 25^\circ\text{C}$, $V^+ = 5\text{V}$, $V^- = 0\text{V}$, $V_{\text{CM}} = V^+/2$, $V_O = V^+/2$ and $R_L > 1\text{M}\Omega$.

Boldface limits apply at the temperature extremes.

Symbol	Parameter	Conditions	Min ⁽²⁾	Typ ⁽³⁾	Max ⁽²⁾	Units
V_O	Output Swing	$R_L = 2\text{k}\Omega$ to 2.5V		32	60 95	mV
			60 95	34		
		$R_L = 10\text{k}\Omega$ to 2.5V		7	30 40	mV
			30 40	7		
I_O	Output Short Circuit Current	Sourcing	85	113		mA
		Sinking	50	75		
t_{on}	Turn-on Time from Shutdown	(LMV341-N)		5		μs
V_{SD}	Shutdown Pin Voltage Range	ON Mode (LMV341-N)		3.1 to 5	4.5 to 5.0	V
		Shutdown Mode (LMV341-N)		0 to 1	0 to 0.8	

5V AC Electrical Characteristics⁽¹⁾

 Unless otherwise specified, all limits specified for $T_J = 25^\circ\text{C}$, $V^+ = 5\text{V}$, $V^- = 0\text{V}$, $V_{\text{CM}} = V^+/2$, $V_O = V^+/2$ and $R_L > 1\text{M}\Omega$.

Boldface limits apply at the temperature extremes.

Symbol	Parameter	Conditions	Min ⁽²⁾	Typ ⁽³⁾	Max ⁽²⁾	Units
SR	Slew Rate	$R_L = 10\text{k}\Omega$ ⁽⁴⁾		1.0		$\text{V}/\mu\text{s}$
GBW	Gain-Bandwidth Product	$R_L = 10\text{k}\Omega$, $C_L = 200\text{pF}$		1.0		MHz
Φ_m	Phase Margin	$R_L = 100\text{k}\Omega$		70		deg
G_m	Gain Margin	$R_L = 100\text{k}\Omega$		20		dB
e_n	Input-Referred Voltage Noise	$f = 1\text{kHz}$		39		$\text{nV}/\sqrt{\text{Hz}}$
i_n	Input-Referred Current Noise	$f = 1\text{kHz}$		0.001		$\text{pA}/\sqrt{\text{Hz}}$
THD	Total Harmonic Distortion	$f = 1\text{kHz}$, $A_V = +1$ $R_L = 600\Omega$, $V_{\text{IN}} = 1\text{V}_{\text{PP}}$		0.012		%

- (1) Electrical Table values apply only for factory testing conditions at the temperature indicated. Factory testing conditions result in very limited self-heating of the device such that $T_J = T_A$. No specification of parametric performance is indicated in the electrical tables under conditions of internal self heating where $T_J > T_A$.
- (2) All limits are specified by testing or statistical analysis.
- (3) Typical values represent the most likely parametric norm as determined at the time of characterization. Actual typical values may vary over time and will also depend on the application and configuration. The typical values are not tested and are not ensured on shipped production material.
- (4) Connected as voltage follower with 2V_{PP} step input. Number specified is the slower of the positive and negative slew rates.

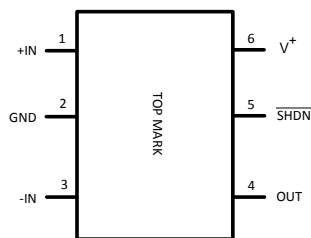
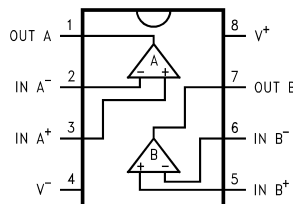
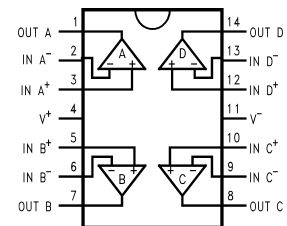
Connection Diagram

Figure 1. 6-Pin SC70 Top View

Figure 2. 8-Pin VSSOP/SOIC Package Number DGK/D Top View

Figure 3. 14-Pin TSSOP/SOIC Package Number PW/D Top View

Typical Performance Characteristics

Supply Current vs. Supply Voltage (LMV341-N)

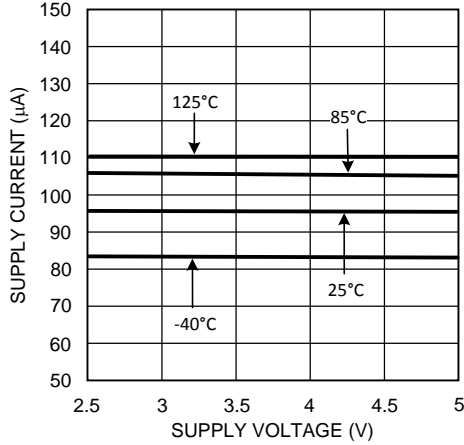

Figure 4.

Input Current vs. Temperature

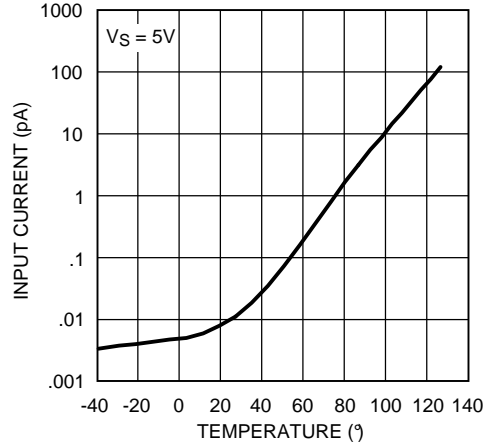

Figure 5.

Output Voltage Swing vs. Supply Voltage

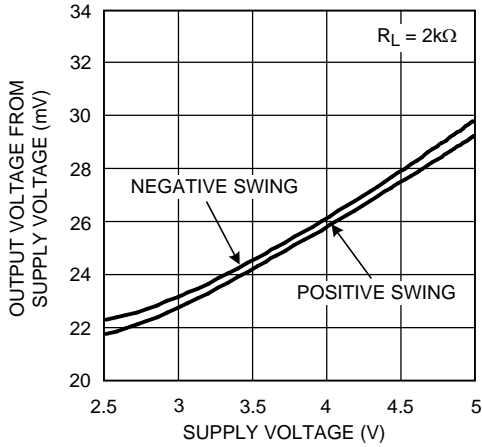

Figure 6.

Output Voltage Swing vs. Supply Voltage

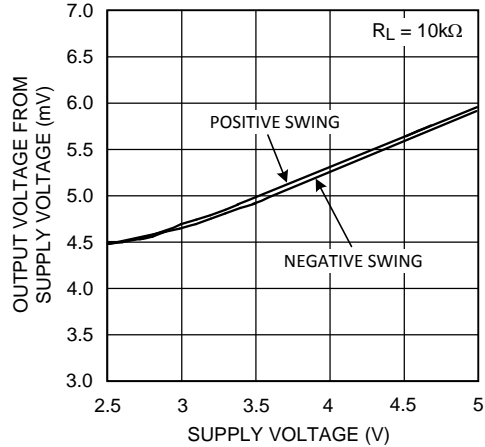

Figure 7.

I_{SOURCE} vs. V_{OUT}

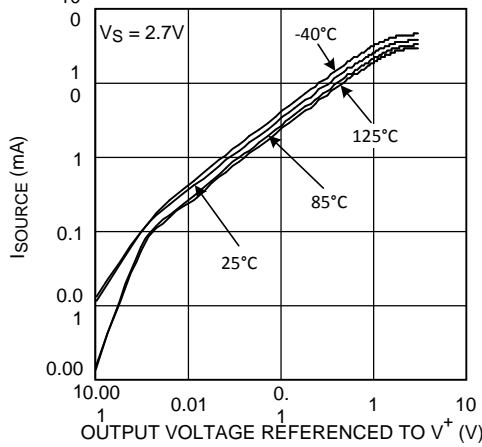

Figure 8.

I_{SOURCE} vs. V_{OUT}

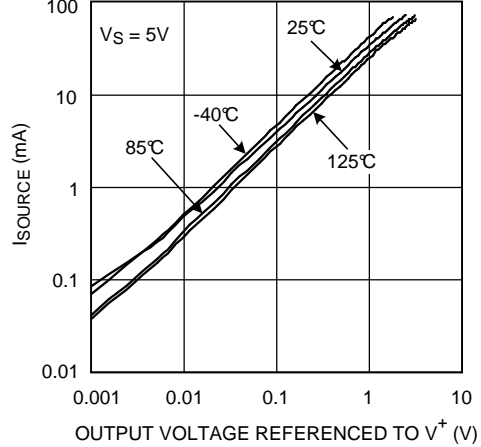

Figure 9.

Typical Performance Characteristics (continued)

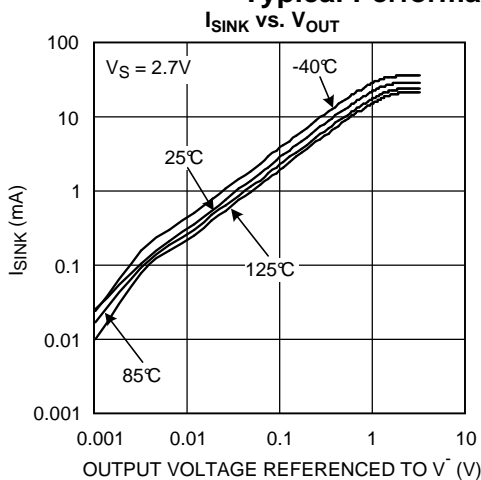

Figure 10.

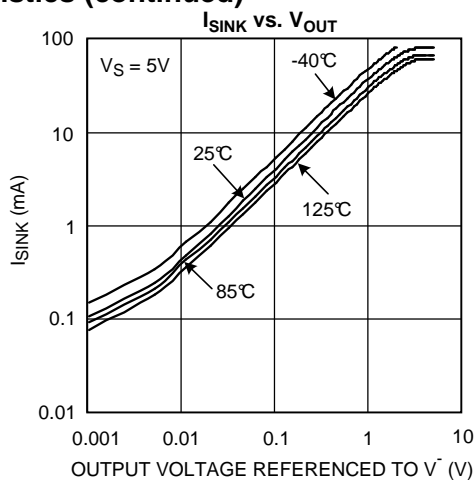

Figure 11.

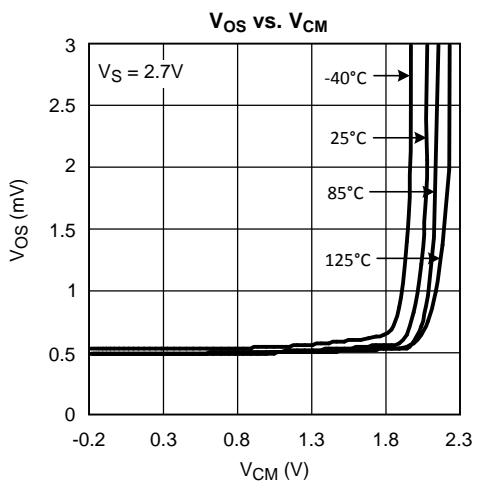

Figure 12.

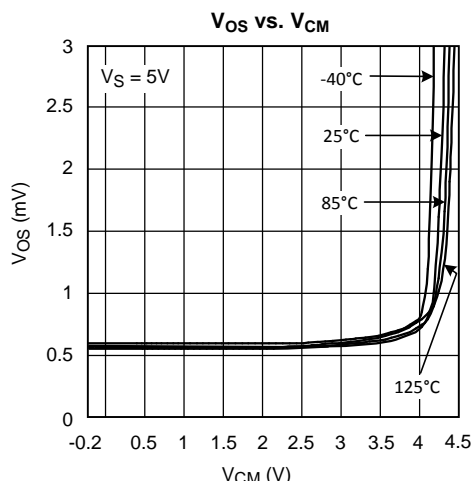

Figure 13.

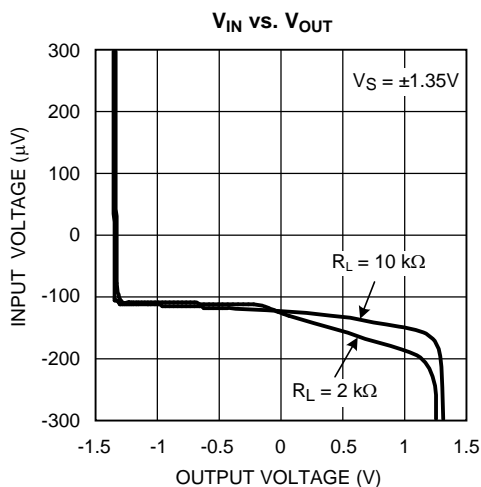

Figure 14.

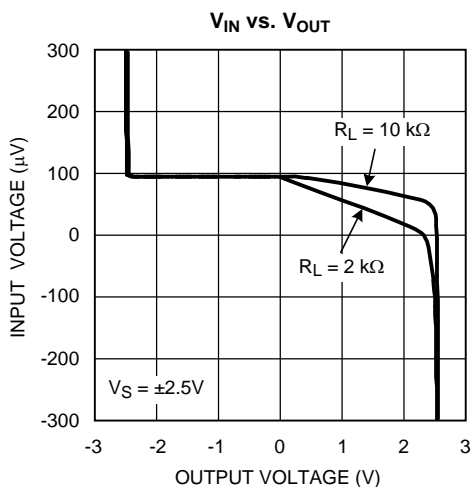

Figure 15.

Typical Performance Characteristics (continued)

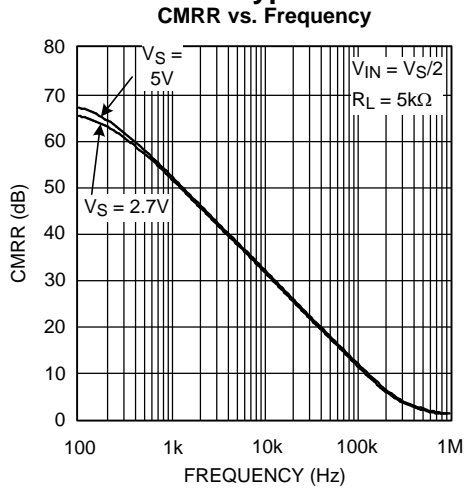

Figure 16.

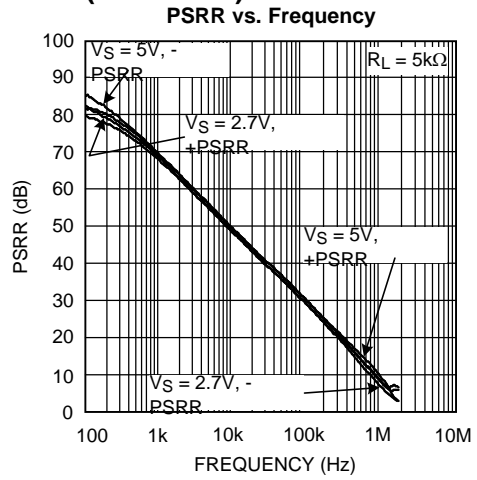

Figure 17.

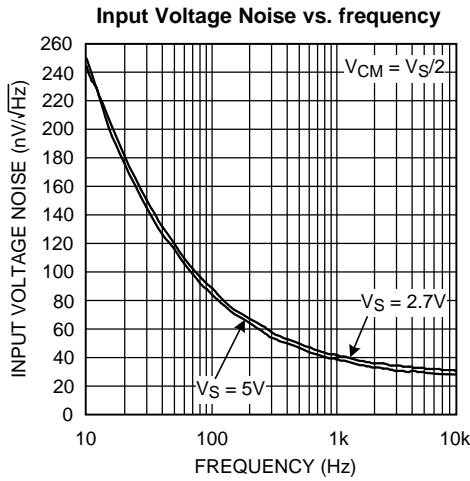

Figure 18.

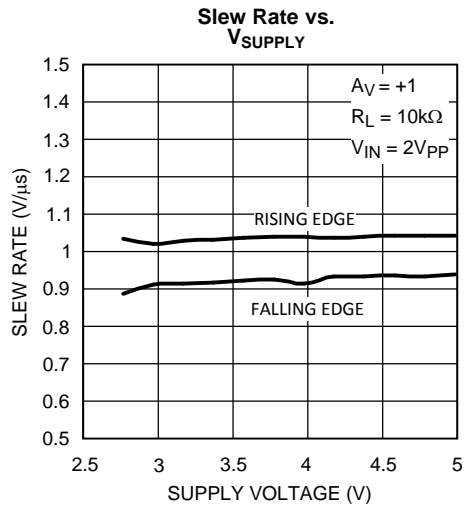

Figure 19.

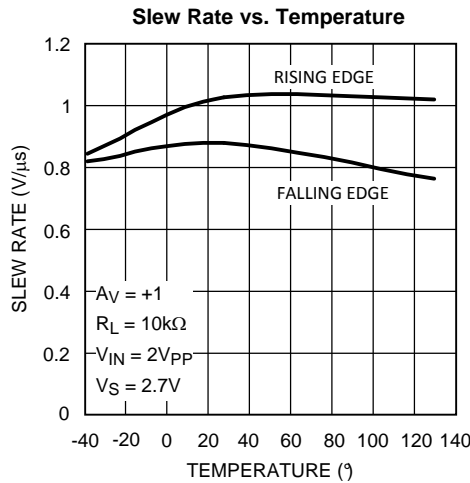

Figure 20.

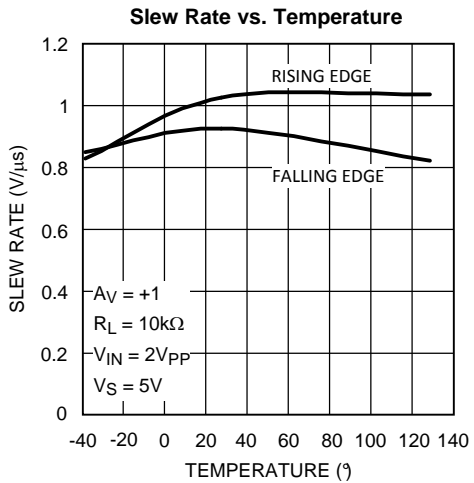

Figure 21.

Typical Performance Characteristics (continued)

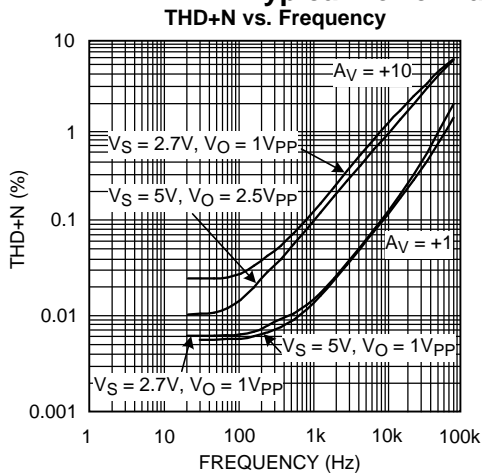

Figure 22.

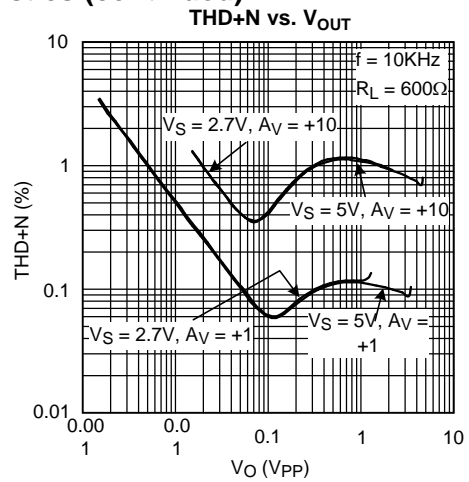

Figure 23.

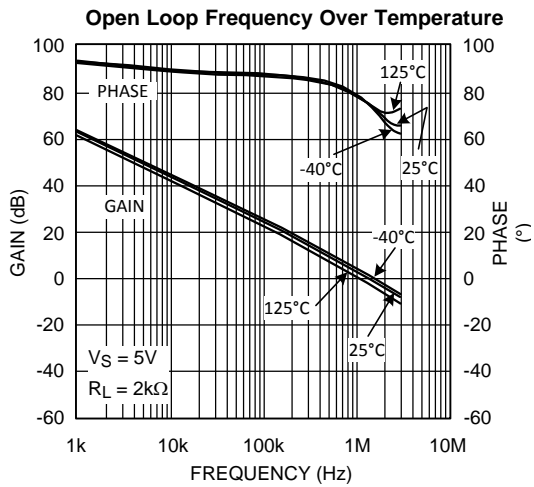

Figure 24.

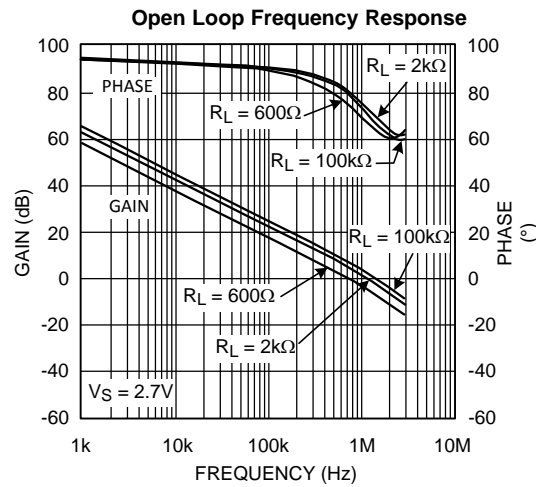

Figure 25.

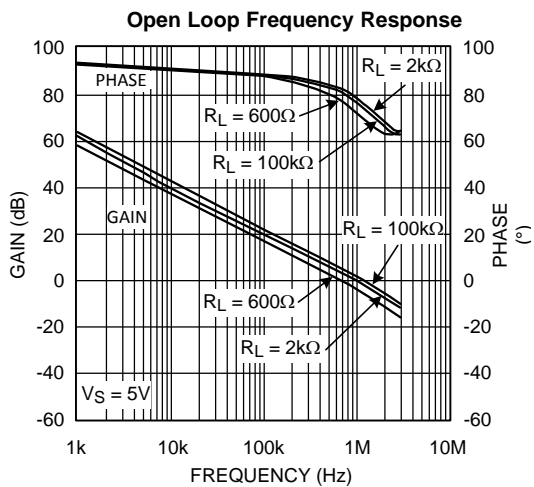

Figure 26.

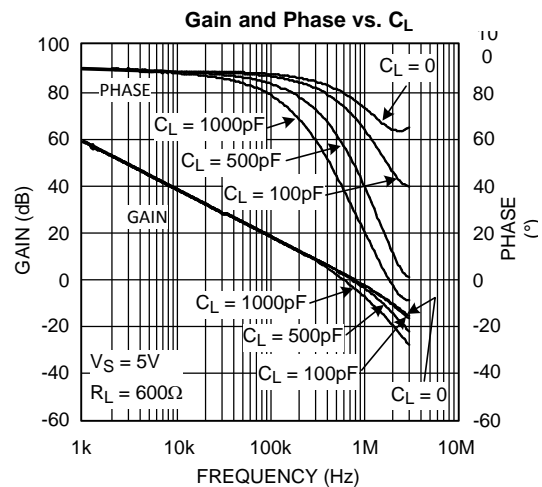

Figure 27.

Typical Performance Characteristics (continued)

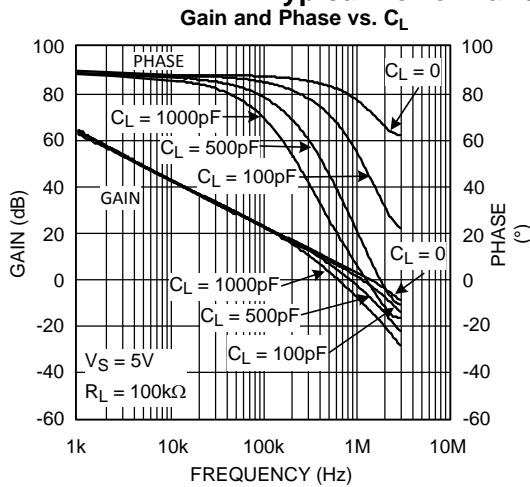

Figure 28.

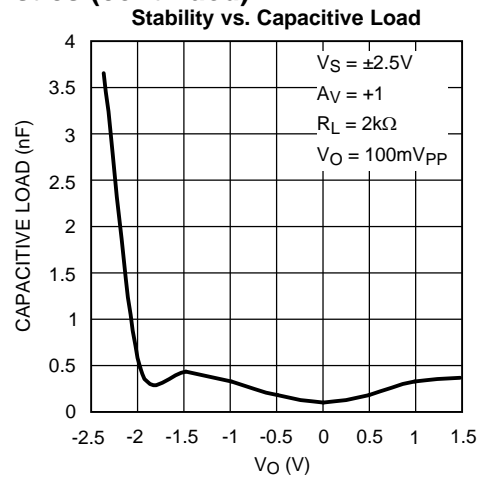

Figure 29.

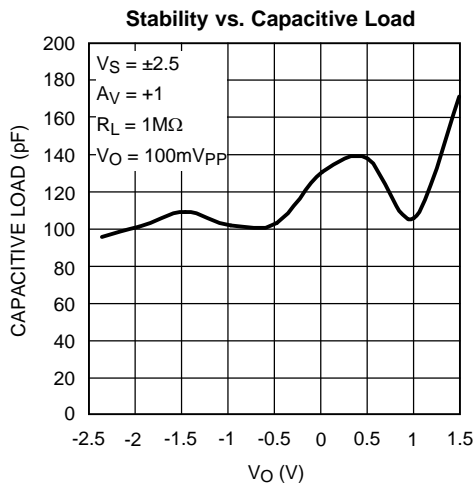

Figure 30.

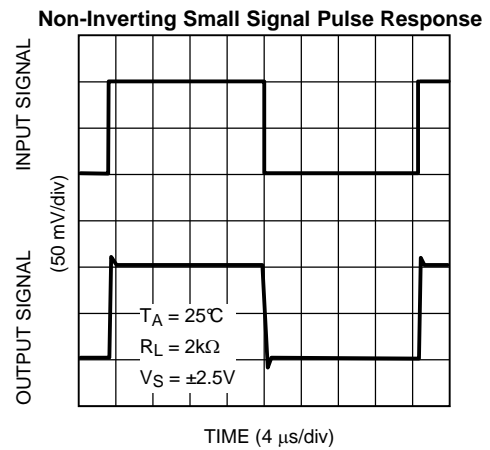

Figure 31.

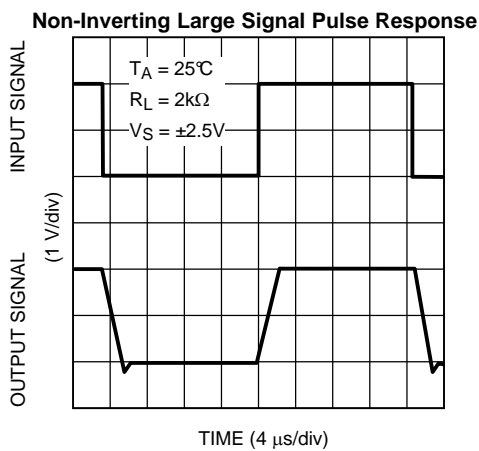

Figure 32.

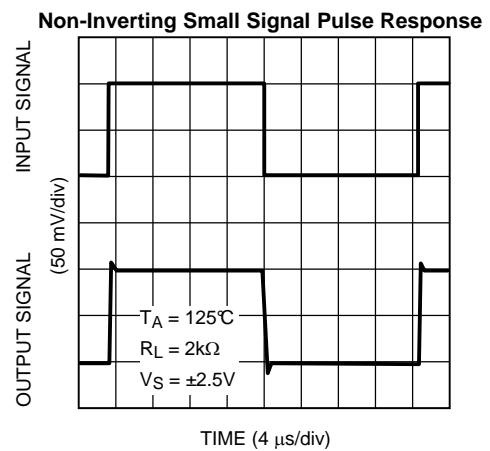

Figure 33.

Typical Performance Characteristics (continued)

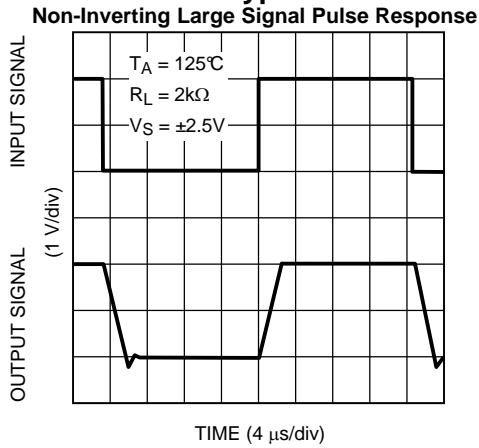

Figure 34.

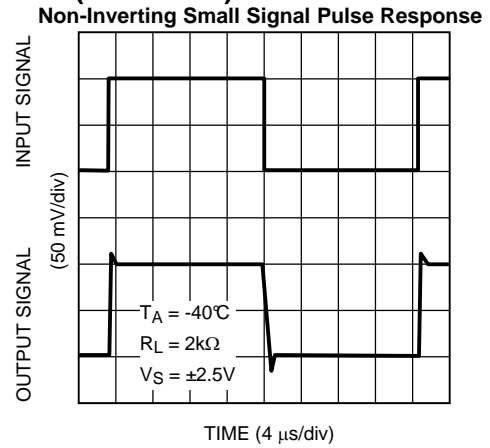

Figure 35.

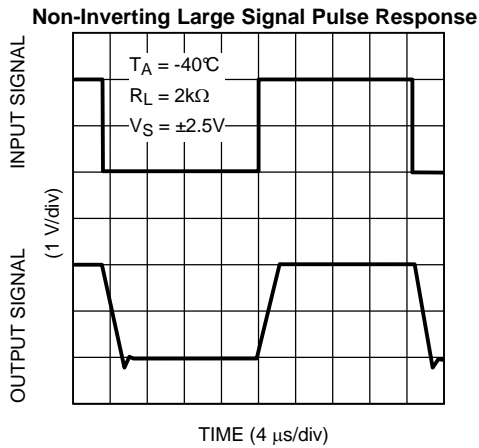

Figure 36.

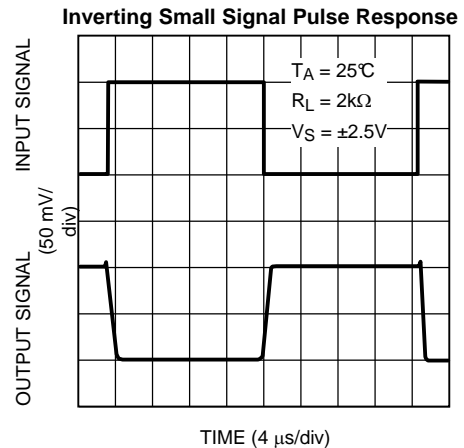

Figure 37.

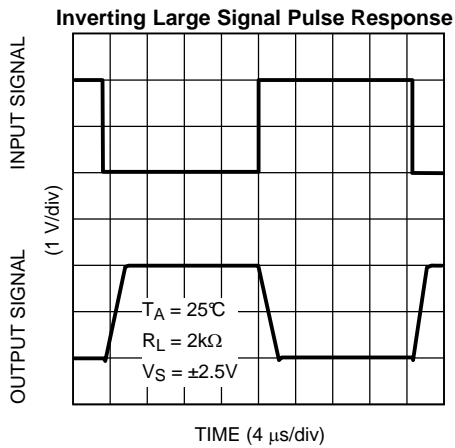

Figure 38.

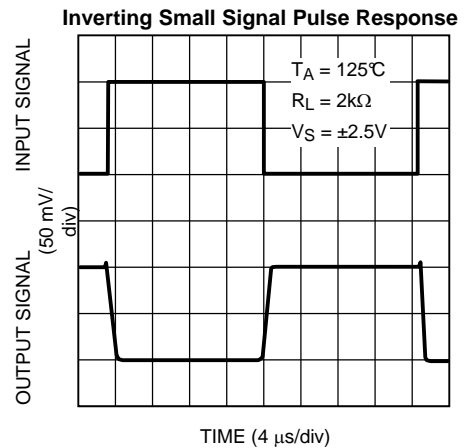

Figure 39.

Typical Performance Characteristics (continued)

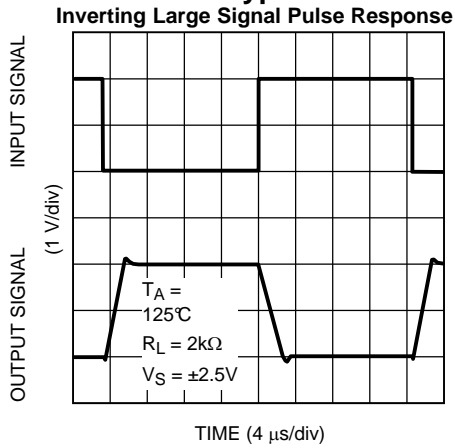

Figure 40.

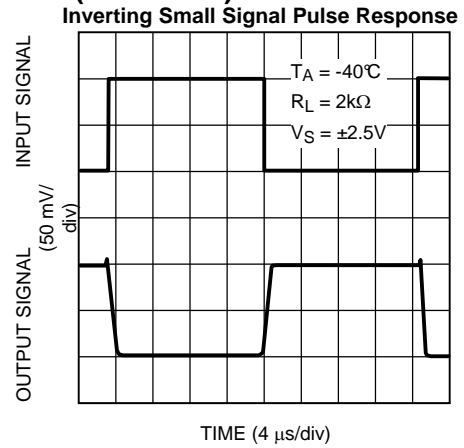

Figure 41.

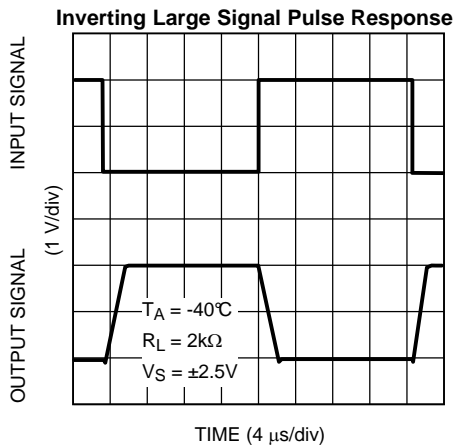

Figure 42.

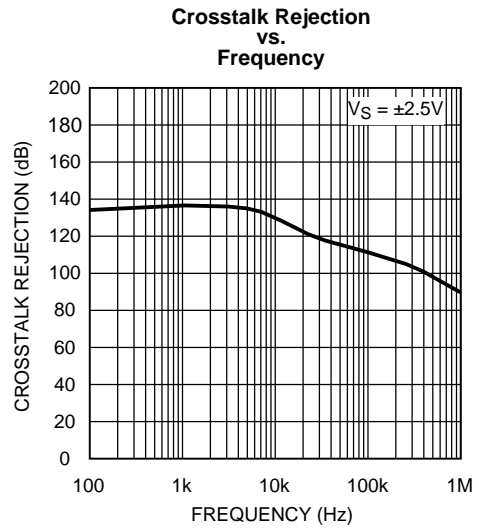

Figure 43.

APPLICATION SECTION

LMV341-N/LMV342-N/LMV344-N

The LMV341-N/LMV342-N/LMV344-N family of amplifiers features low voltage, low power, and rail-to-rail output operational amplifiers designed for low voltage portable applications. The family is designed using all CMOS technology. This results in an ultra low input bias current. The LMV341-N has a shutdown option, which can be used in portable devices to increase battery life.

A simplified schematic of the LMV341-N/LMV342-N/LMV344-N family of amplifiers is shown in [Figure 44](#). The PMOS input differential pair allows the input to include ground. The output of this differential pair is connected to the Class AB turnaround stage. This Class AB turnaround has a lower quiescent current, compared to regular turnaround stages. This results in lower offset, noise, and power dissipation, while slew rate equals that of a conventional turnaround stage. The output of the Class AB turnaround stage provides gate voltage to the complementary common-source transistors at the output stage. These transistors enable the device to have rail-to-rail output.

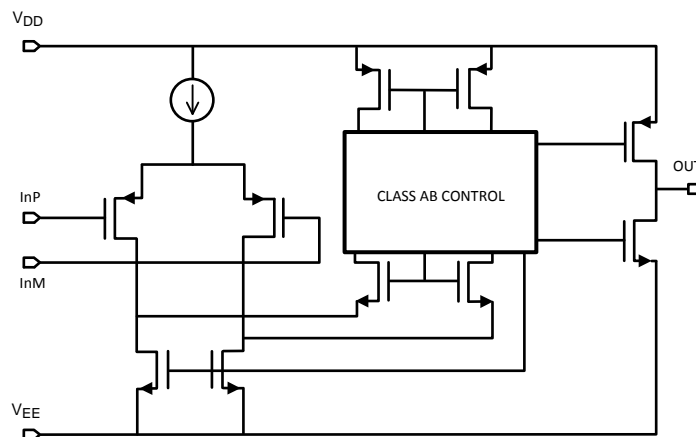

Figure 44. Simplified Schematic

Class AB Turnaround Stage Amplifier

This patented folded cascode stage has a combined class AB amplifier stage, which replaces the conventional folded cascode stage. Therefore, the class AB folded cascode stage runs at a much lower quiescent current compared to conventional folded cascode stages. This results in significantly smaller offset and noise contributions. The reduced offset and noise contributions in turn reduce the offset voltage level and the voltage noise level at the input of the LMV341-N/LMV342-N/LMV344-N. Also the lower quiescent current results in a high open-loop gain for the amplifier. The lower quiescent current does not affect the slew rate of the amplifier nor its ability to handle the total current swing coming from the input stage.

The input voltage noise of the device at low frequencies, below 1kHz, is slightly higher than devices with a BJT input stage; However the PMOS input stage results in a much lower input bias current and the input voltage noise drops at frequencies above 1kHz.

Sample and Hold Circuit

The lower input bias current of the LMV341-N results in a very high input impedance. The output impedance when the device is in shutdown mode is quite high. These high impedances, along with the ability of the shutdown pin to be derived from a separate power source, make LMV341-N a good choice for sample and hold circuits. The sample clock should be connected to the shutdown pin of the amplifier to rapidly turn the device on or off.

Figure 45 shows the schematic of a simple sample and hold circuit. When the sample clock is high the first amplifier is in normal operation mode and the second amplifier acts as a buffer. The capacitor, which appears as a load on the first amplifier, will be charging at this time. The voltage across the capacitor is that of the non-inverting input of the first amplifier since it is connected as a voltage-follower. When the sample clock is low the first amplifier is shut off, bringing the output impedance to a high value. The high impedance of this output, along with the very high impedance on the input of the second amplifier, prevents the capacitor from discharging. There is very little voltage droop while the first amplifier is in shutdown mode. The second amplifier, which is still in normal operation mode and is connected as a voltage follower, also provides the voltage sampled on the capacitor at its output.

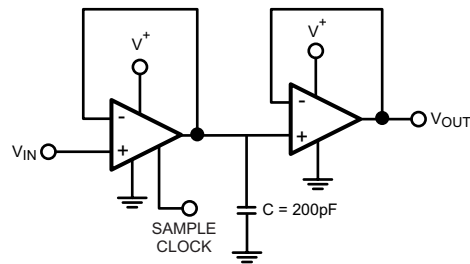

Figure 45. Sample and Hold Circuit

Shutdown Feature

The LMV341-N is capable of being turned off in order to conserve power and increase battery life in portable devices. Once in shutdown mode the supply current is drastically reduced, 1 μ A maximum, and the output will be "tri-stated."

The device will be disabled when the shutdown pin voltage is pulled low. The shutdown pin should never be left unconnected. Leaving the pin floating will result in an undefined operation mode and the device may oscillate between shutdown and active modes.

The LMV341-N typically turns on 2.8 μ s after the shutdown voltage is pulled high. The device turns off in less than 400ns after shutdown voltage is pulled low. Figure 46 and Figure 47 show the turn-on and turn-off time of the LMV341-N, respectively. In order to reduce the effect of the capacitance added to the circuit by the scope probe, in the turn-off time circuit a resistive load of 600 Ω is added. Figure 48 and Figure 49 show the test circuits used to obtain the two plots.

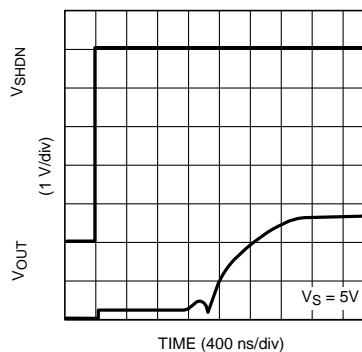

Figure 46. Turn-on Time

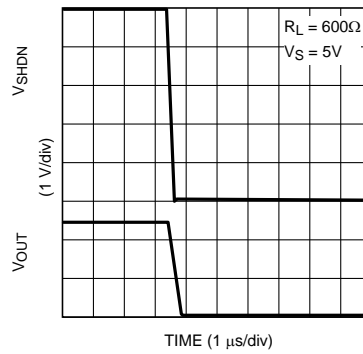

Figure 47. Turn-off Time

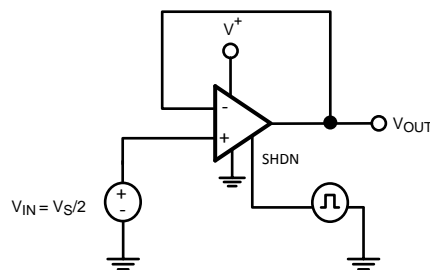

Figure 48. Turn-on Time

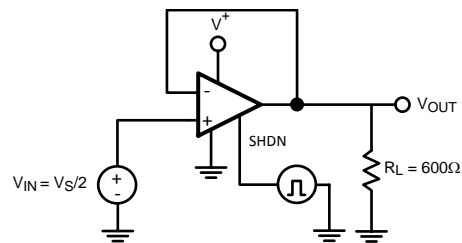

Figure 49. Turn-off Time

Low Input Bias Current

The LMV341-N/LMV342-N/LMV344-N Amplifiers have a PMOS input stage. As a result, they will have a much lower input bias current than devices with BJT input stages. This feature makes these devices ideal for sensor circuits. A typical curve of the input bias current of the LMV341-N is shown in [Figure 50](#).

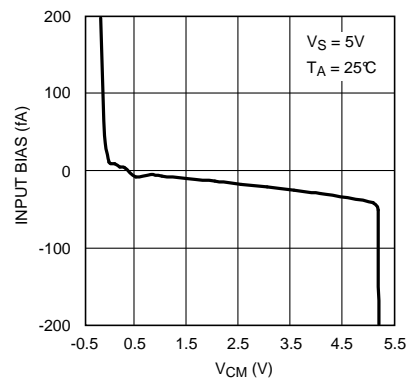

Figure 50. Input Bias Current vs. V_{CM}

REVISION HISTORY

Changes from Revision F (March 2013) to Revision G	Page
<hr/> <ul style="list-style-type: none">• Changed layout of National Data Sheet to TI format	<hr/> 16

PACKAGING INFORMATION

Orderable Device	Status (1)	Package Type	Package Drawing	Pins	Package Qty	Eco Plan (2)	Lead/Ball Finish (6)	MSL Peak Temp (3)	Op Temp (°C)	Device Marking (4/5)	Samples
LMV341MG/NOPB	ACTIVE	SC70	DCK	6	1000	Green (RoHS & no Sb/Br)	CU SN	Level-1-260C-UNLIM	-40 to 125	A78	Samples
LMV341MGX/NOPB	ACTIVE	SC70	DCK	6	3000	Green (RoHS & no Sb/Br)	CU SN	Level-1-260C-UNLIM	-40 to 125	A78	Samples
LMV342MA/NOPB	ACTIVE	SOIC	D	8	95	Green (RoHS & no Sb/Br)	CU SN	Level-1-260C-UNLIM	-40 to 125	LMV34 2MA	Samples
LMV342MAX	NRND	SOIC	D	8	2500	TBD	Call TI	Call TI	-40 to 125	LMV34 2MA	
LMV342MAX/NOPB	ACTIVE	SOIC	D	8	2500	Green (RoHS & no Sb/Br)	CU SN	Level-1-260C-UNLIM	-40 to 125	LMV34 2MA	Samples
LMV342MM/NOPB	ACTIVE	VSSOP	DGK	8	1000	Green (RoHS & no Sb/Br)	CU SN	Level-1-260C-UNLIM	-40 to 125	A82A	Samples
LMV342MMX/NOPB	ACTIVE	VSSOP	DGK	8	3500	Green (RoHS & no Sb/Br)	CU SN	Level-1-260C-UNLIM	-40 to 125	A82A	Samples
LMV344MA/NOPB	ACTIVE	SOIC	D	14	55	Green (RoHS & no Sb/Br)	CU SN	Level-1-260C-UNLIM	-40 to 125	LMV344MA	Samples
LMV344MAX/NOPB	ACTIVE	SOIC	D	14	2500	Green (RoHS & no Sb/Br)	CU SN	Level-1-260C-UNLIM	-40 to 125	LMV344MA	Samples
LMV344MT/NOPB	ACTIVE	TSSOP	PW	14	94	Green (RoHS & no Sb/Br)	CU NIPDAU CU SN	Level-1-260C-UNLIM	-40 to 125	LMV34 4MT	Samples
LMV344MTX	NRND	TSSOP	PW	14	2500	TBD	Call TI	Call TI	-40 to 125	LMV34 4MT	
LMV344MTX/NOPB	ACTIVE	TSSOP	PW	14	2500	Green (RoHS & no Sb/Br)	CU NIPDAU CU SN	Level-1-260C-UNLIM	-40 to 125	LMV34 4MT	Samples

(1) The marketing status values are defined as follows:

ACTIVE: Product device recommended for new designs.

LIFEBUY: TI has announced that the device will be discontinued, and a lifetime-buy period is in effect.

NRND: Not recommended for new designs. Device is in production to support existing customers, but TI does not recommend using this part in a new design.

PREVIEW: Device has been announced but is not in production. Samples may or may not be available.

OBSELETE: TI has discontinued the production of the device.

(2) Eco Plan - The planned eco-friendly classification: Pb-Free (RoHS), Pb-Free (RoHS Exempt), or Green (RoHS & no Sb/Br) - please check <http://www.ti.com/productcontent> for the latest availability information and additional product content details.

TBD: The Pb-Free/Green conversion plan has not been defined.

Pb-Free (RoHS): TI's terms "Lead-Free" or "Pb-Free" mean semiconductor products that are compatible with the current RoHS requirements for all 6 substances, including the requirement that lead not exceed 0.1% by weight in homogeneous materials. Where designed to be soldered at high temperatures, TI Pb-Free products are suitable for use in specified lead-free processes.

Pb-Free (RoHS Exempt): This component has a RoHS exemption for either 1) lead-based flip-chip solder bumps used between the die and package, or 2) lead-based die adhesive used between the die and leadframe. The component is otherwise considered Pb-Free (RoHS compatible) as defined above.

Green (RoHS & no Sb/Br): TI defines "Green" to mean Pb-Free (RoHS compatible), and free of Bromine (Br) and Antimony (Sb) based flame retardants (Br or Sb do not exceed 0.1% by weight in homogeneous material)

⁽³⁾ MSL, Peak Temp. - The Moisture Sensitivity Level rating according to the JEDEC industry standard classifications, and peak solder temperature.

⁽⁴⁾ There may be additional marking, which relates to the logo, the lot trace code information, or the environmental category on the device.

⁽⁵⁾ Multiple Device Markings will be inside parentheses. Only one Device Marking contained in parentheses and separated by a "~" will appear on a device. If a line is indented then it is a continuation of the previous line and the two combined represent the entire Device Marking for that device.

⁽⁶⁾ Lead/Ball Finish - Orderable Devices may have multiple material finish options. Finish options are separated by a vertical ruled line. Lead/Ball Finish values may wrap to two lines if the finish value exceeds the maximum column width.

Important Information and Disclaimer:The information provided on this page represents TI's knowledge and belief as of the date that it is provided. TI bases its knowledge and belief on information provided by third parties, and makes no representation or warranty as to the accuracy of such information. Efforts are underway to better integrate information from third parties. TI has taken and continues to take reasonable steps to provide representative and accurate information but may not have conducted destructive testing or chemical analysis on incoming materials and chemicals. TI and TI suppliers consider certain information to be proprietary, and thus CAS numbers and other limited information may not be available for release.

In no event shall TI's liability arising out of such information exceed the total purchase price of the TI part(s) at issue in this document sold by TI to Customer on an annual basis.

TAPE AND REEL INFORMATION

QUADRANT ASSIGNMENTS FOR PIN 1 ORIENTATION IN TAPE

*All dimensions are nominal

Device	Package Type	Package Drawing	Pins	SPQ	Reel Diameter (mm)	Reel Width W1 (mm)	A0 (mm)	B0 (mm)	K0 (mm)	P1 (mm)	W (mm)	Pin1 Quadrant
LMV341MG/NOPB	SC70	DCK	6	1000	178.0	8.4	2.25	2.45	1.2	4.0	8.0	Q3
LMV341MGX/NOPB	SC70	DCK	6	3000	178.0	8.4	2.25	2.45	1.2	4.0	8.0	Q3
LMV342MAX	SOIC	D	8	2500	330.0	12.4	6.5	5.4	2.0	8.0	12.0	Q1
LMV342MAX/NOPB	SOIC	D	8	2500	330.0	12.4	6.5	5.4	2.0	8.0	12.0	Q1
LMV342MM/NOPB	VSSOP	DGK	8	1000	178.0	12.4	5.3	3.4	1.4	8.0	12.0	Q1
LMV342MMX/NOPB	VSSOP	DGK	8	3500	330.0	12.4	5.3	3.4	1.4	8.0	12.0	Q1
LMV344MAX/NOPB	SOIC	D	14	2500	330.0	16.4	6.5	9.35	2.3	8.0	16.0	Q1
LMV344MTX	TSSOP	PW	14	2500	330.0	12.4	6.95	8.3	1.6	8.0	12.0	Q1
LMV344MTX/NOPB	TSSOP	PW	14	2500	330.0	12.4	6.95	8.3	1.6	8.0	12.0	Q1

TAPE AND REEL BOX DIMENSIONS

*All dimensions are nominal

Device	Package Type	Package Drawing	Pins	SPQ	Length (mm)	Width (mm)	Height (mm)
LMV341MG/NOPB	SC70	DCK	6	1000	210.0	185.0	35.0
LMV341MGX/NOPB	SC70	DCK	6	3000	210.0	185.0	35.0
LMV342MAX	SOIC	D	8	2500	367.0	367.0	35.0
LMV342MAX/NOPB	SOIC	D	8	2500	367.0	367.0	35.0
LMV342MM/NOPB	VSSOP	DGK	8	1000	210.0	185.0	35.0
LMV342MMX/NOPB	VSSOP	DGK	8	3500	367.0	367.0	35.0
LMV344MAX/NOPB	SOIC	D	14	2500	367.0	367.0	35.0
LMV344MTX	TSSOP	PW	14	2500	367.0	367.0	35.0
LMV344MTX/NOPB	TSSOP	PW	14	2500	367.0	367.0	35.0

DCK (R-PDSO-G6)

PLASTIC SMALL OUTLINE

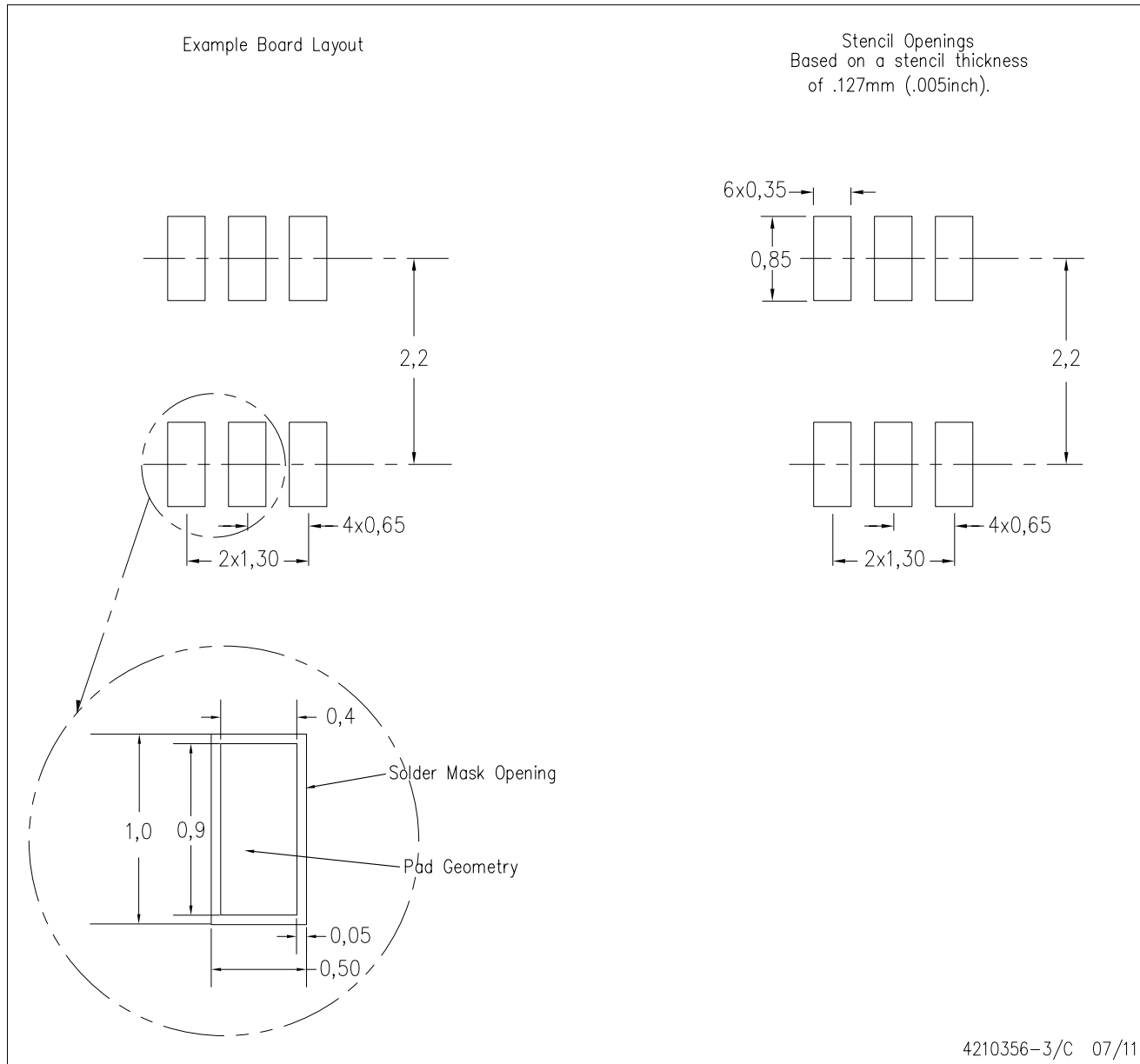

- NOTES:
- A. All linear dimensions are in millimeters.
 - B. This drawing is subject to change without notice.
 - C. Customers should place a note on the circuit board fabrication drawing not to alter the center solder mask defined pad.
 - D. Publication IPC-7351 is recommended for alternate designs.
 - E. Laser cutting apertures with trapezoidal walls and also rounding corners will offer better paste release. Customers should contact their board assembly site for stencil design recommendations. Example stencil design based on a 50% volumetric metal load solder paste. Refer to IPC-7525 for other stencil recommendations.

D (R-PDSO-G14)

PLASTIC SMALL OUTLINE

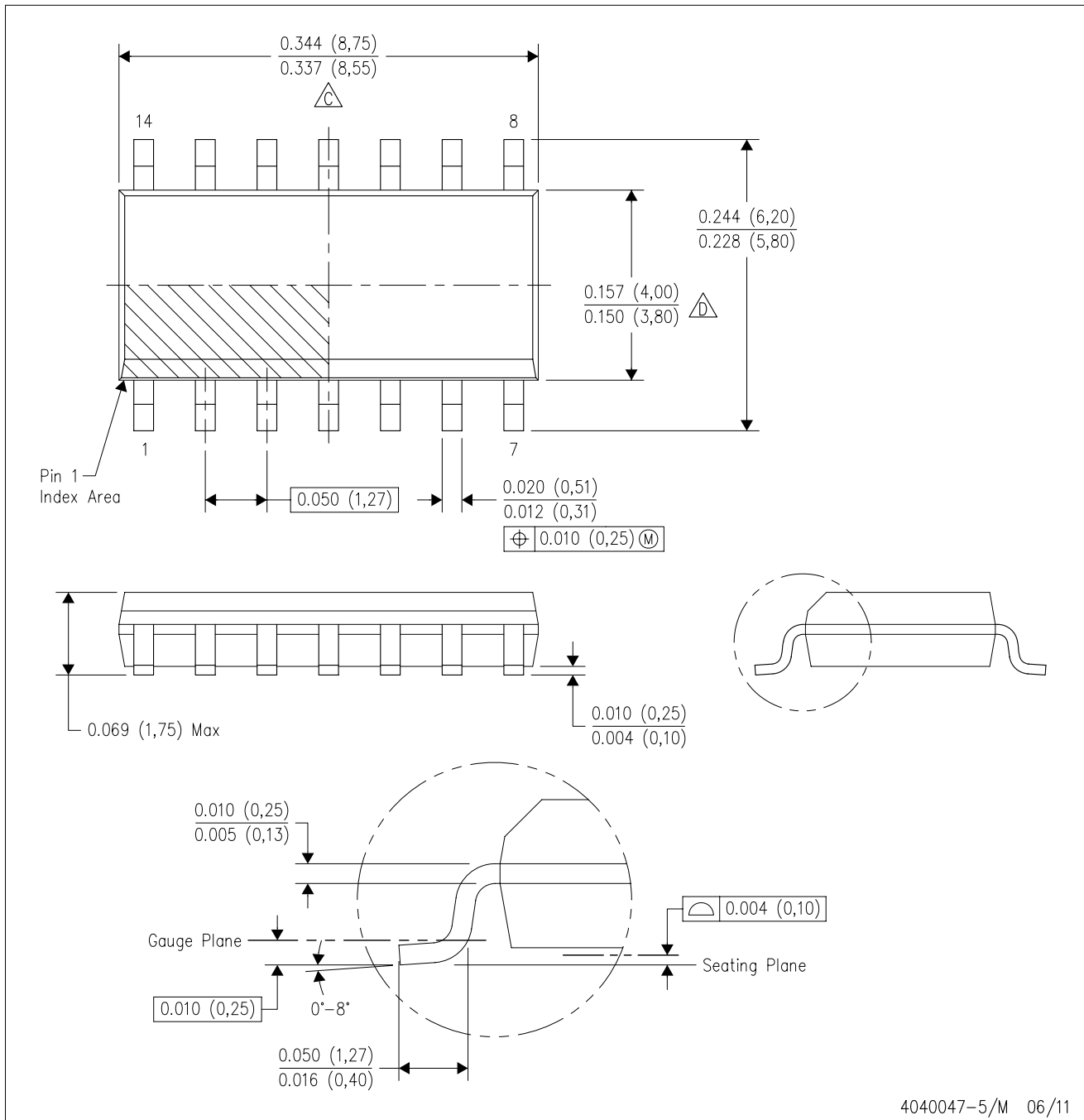

- NOTES:
- A. All linear dimensions are in inches (millimeters).
 - B. This drawing is subject to change without notice.
 -  Body length does not include mold flash, protrusions, or gate burrs. Mold flash, protrusions, or gate burrs shall not exceed 0.006 (0,15) each side.
 -  Body width does not include interlead flash. Interlead flash shall not exceed 0.017 (0,43) each side.
 - E. Reference JEDEC MS-012 variation AB.

PW (R-PDSO-G14)

PLASTIC SMALL OUTLINE

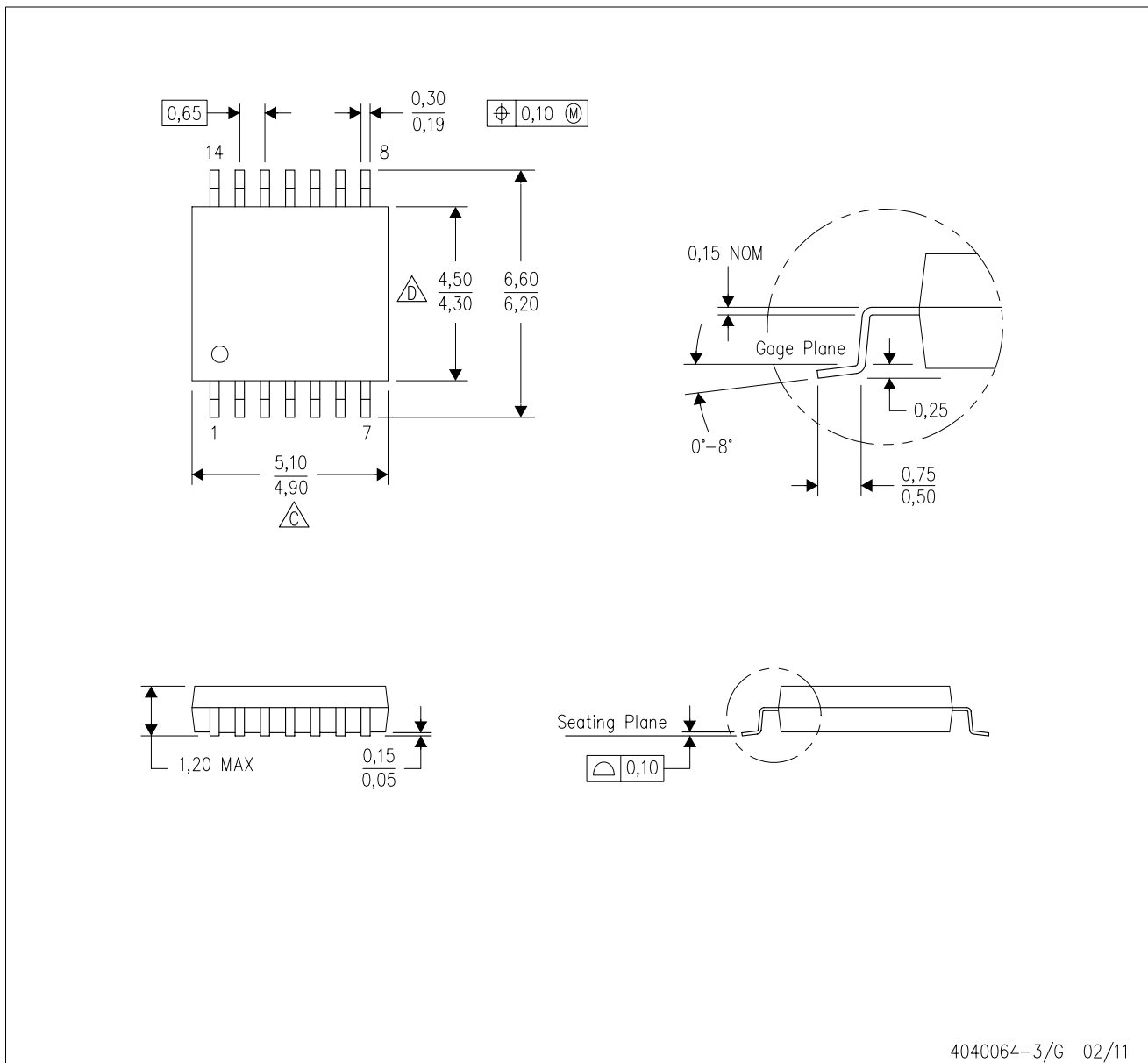

- NOTES:
- A. All linear dimensions are in millimeters. Dimensioning and tolerancing per ASME Y14.5M-1994.
 - B. This drawing is subject to change without notice.
 - C. Body length does not include mold flash, protrusions, or gate burrs. Mold flash, protrusions, or gate burrs shall not exceed 0,15 each side.
 - D. Body width does not include interlead flash. Interlead flash shall not exceed 0,25 each side.
 - E. Falls within JEDEC MO-153

PW (R-PDSO-G14)

PLASTIC SMALL OUTLINE

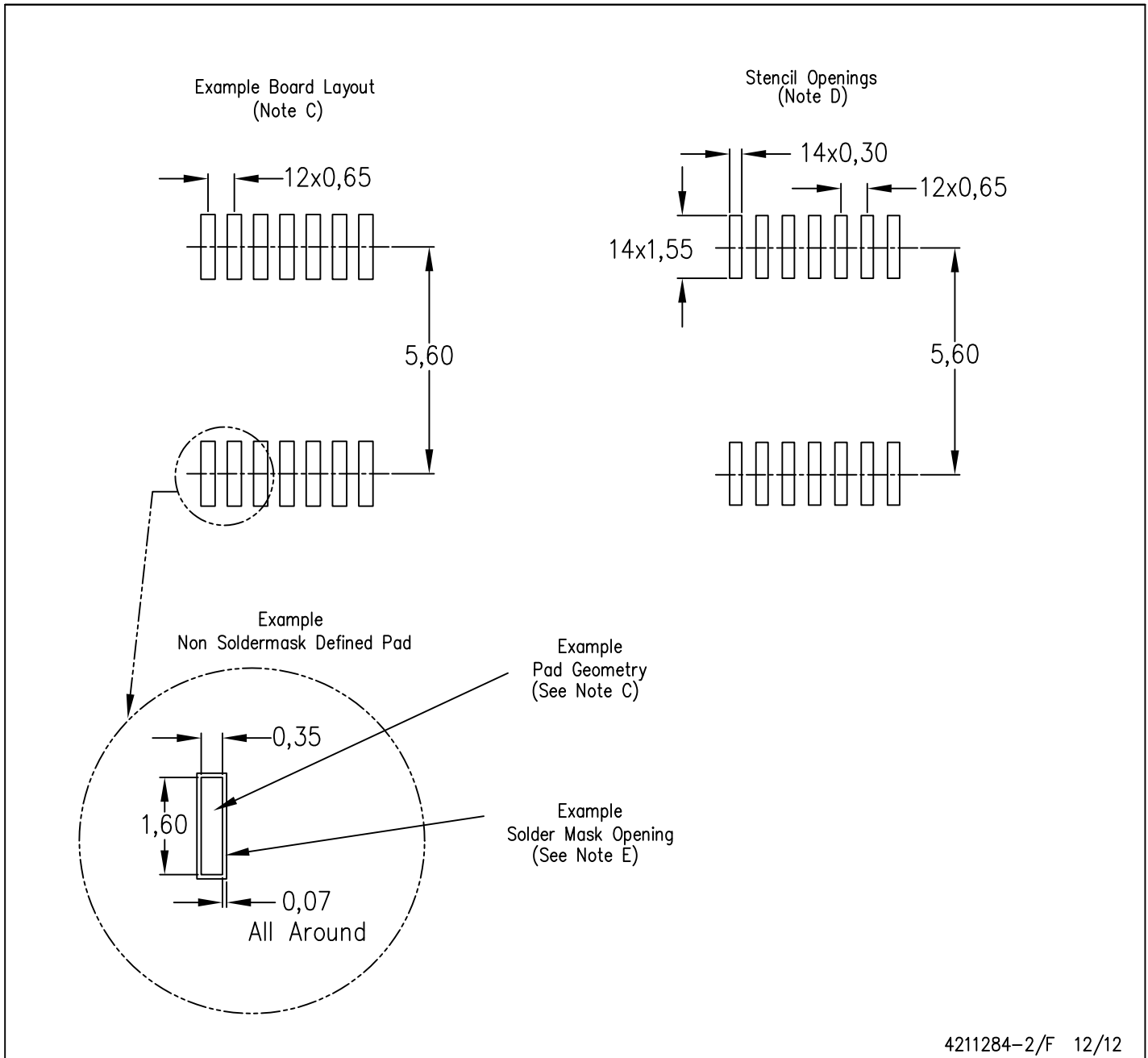

- NOTES:
- All linear dimensions are in millimeters.
 - This drawing is subject to change without notice.
 - Publication IPC-7351 is recommended for alternate designs.
 - Laser cutting apertures with trapezoidal walls and also rounding corners will offer better paste release. Customers should contact their board assembly site for stencil design recommendations. Refer to IPC-7525 for other stencil recommendations.
 - Customers should contact their board fabrication site for solder mask tolerances between and around signal pads.

D (R-PDSO-G8)

PLASTIC SMALL OUTLINE

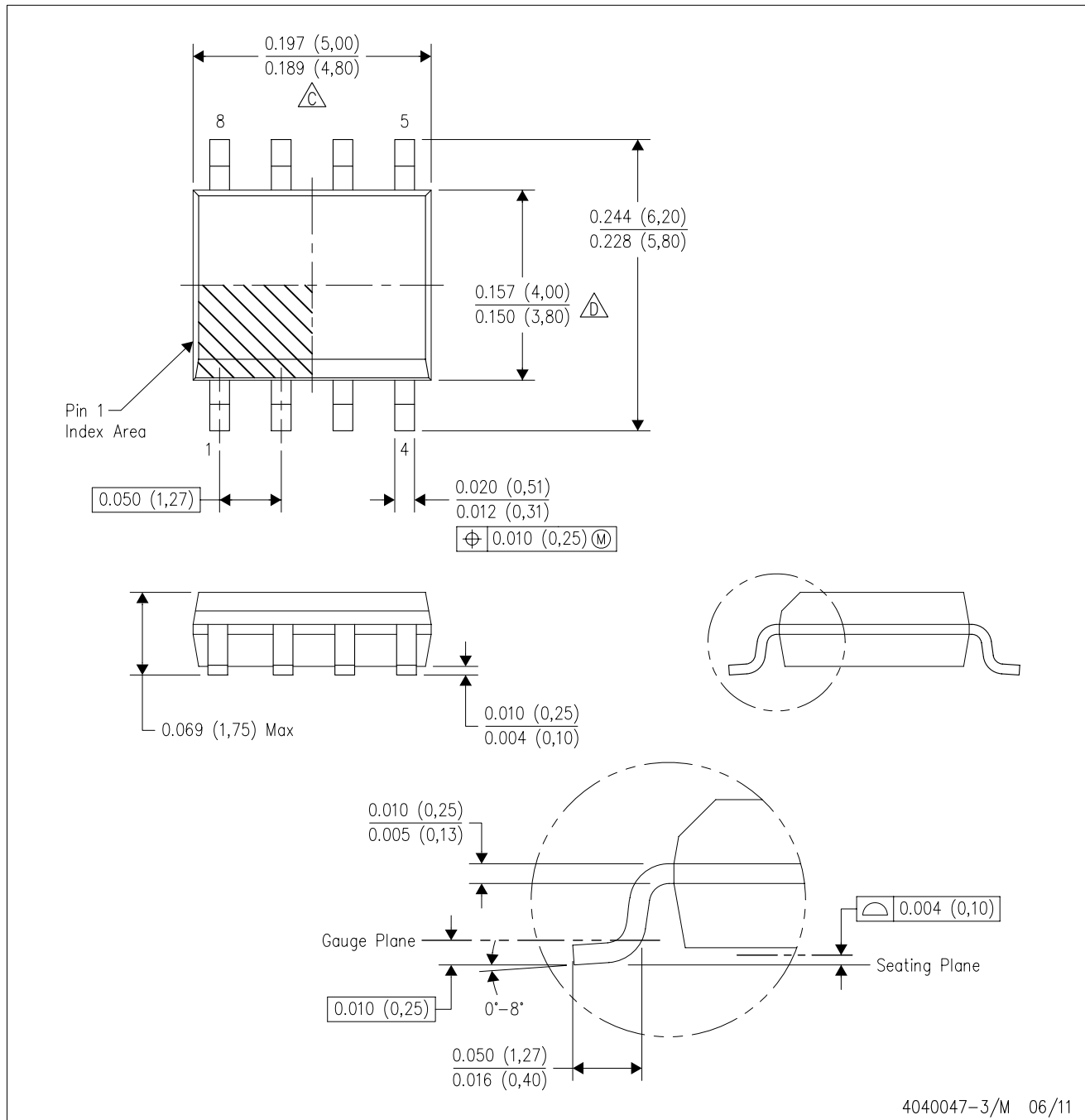

- NOTES:
- A. All linear dimensions are in inches (millimeters).
 - B. This drawing is subject to change without notice.
 - Body length does not include mold flash, protrusions, or gate burrs. Mold flash, protrusions, or gate burrs shall not exceed 0.006 (0,15) each side.
 - Body width does not include interlead flash. Interlead flash shall not exceed 0.017 (0,43) each side.
 - E. Reference JEDEC MS-012 variation AA.

IMPORTANT NOTICE

Texas Instruments Incorporated and its subsidiaries (TI) reserve the right to make corrections, enhancements, improvements and other changes to its semiconductor products and services per JESD46, latest issue, and to discontinue any product or service per JESD48, latest issue. Buyers should obtain the latest relevant information before placing orders and should verify that such information is current and complete. All semiconductor products (also referred to herein as "components") are sold subject to TI's terms and conditions of sale supplied at the time of order acknowledgment.

TI warrants performance of its components to the specifications applicable at the time of sale, in accordance with the warranty in TI's terms and conditions of sale of semiconductor products. Testing and other quality control techniques are used to the extent TI deems necessary to support this warranty. Except where mandated by applicable law, testing of all parameters of each component is not necessarily performed.

TI assumes no liability for applications assistance or the design of Buyers' products. Buyers are responsible for their products and applications using TI components. To minimize the risks associated with Buyers' products and applications, Buyers should provide adequate design and operating safeguards.

TI does not warrant or represent that any license, either express or implied, is granted under any patent right, copyright, mask work right, or other intellectual property right relating to any combination, machine, or process in which TI components or services are used. Information published by TI regarding third-party products or services does not constitute a license to use such products or services or a warranty or endorsement thereof. Use of such information may require a license from a third party under the patents or other intellectual property of the third party, or a license from TI under the patents or other intellectual property of TI.

Reproduction of significant portions of TI information in TI data books or data sheets is permissible only if reproduction is without alteration and is accompanied by all associated warranties, conditions, limitations, and notices. TI is not responsible or liable for such altered documentation. Information of third parties may be subject to additional restrictions.

Resale of TI components or services with statements different from or beyond the parameters stated by TI for that component or service voids all express and any implied warranties for the associated TI component or service and is an unfair and deceptive business practice. TI is not responsible or liable for any such statements.

Buyer acknowledges and agrees that it is solely responsible for compliance with all legal, regulatory and safety-related requirements concerning its products, and any use of TI components in its applications, notwithstanding any applications-related information or support that may be provided by TI. Buyer represents and agrees that it has all the necessary expertise to create and implement safeguards which anticipate dangerous consequences of failures, monitor failures and their consequences, lessen the likelihood of failures that might cause harm and take appropriate remedial actions. Buyer will fully indemnify TI and its representatives against any damages arising out of the use of any TI components in safety-critical applications.

In some cases, TI components may be promoted specifically to facilitate safety-related applications. With such components, TI's goal is to help enable customers to design and create their own end-product solutions that meet applicable functional safety standards and requirements. Nonetheless, such components are subject to these terms.

No TI components are authorized for use in FDA Class III (or similar life-critical medical equipment) unless authorized officers of the parties have executed a special agreement specifically governing such use.

Only those TI components which TI has specifically designated as military grade or "enhanced plastic" are designed and intended for use in military/aerospace applications or environments. Buyer acknowledges and agrees that any military or aerospace use of TI components which have **not** been so designated is solely at the Buyer's risk, and that Buyer is solely responsible for compliance with all legal and regulatory requirements in connection with such use.

TI has specifically designated certain components as meeting ISO/TS16949 requirements, mainly for automotive use. In any case of use of non-designated products, TI will not be responsible for any failure to meet ISO/TS16949.

Products

Audio	www.ti.com/audio
Amplifiers	amplifier.ti.com
Data Converters	dataconverter.ti.com
DLP® Products	www.dlp.com
DSP	dsp.ti.com
Clocks and Timers	www.ti.com/clocks
Interface	interface.ti.com
Logic	logic.ti.com
Power Mgmt	power.ti.com
Microcontrollers	microcontroller.ti.com
RFID	www.ti-rfid.com
OMAP Applications Processors	www.ti.com/omap
Wireless Connectivity	www.ti.com/wirelessconnectivity

Applications

Automotive and Transportation	www.ti.com/automotive
Communications and Telecom	www.ti.com/communications
Computers and Peripherals	www.ti.com/computers
Consumer Electronics	www.ti.com/consumer-apps
Energy and Lighting	www.ti.com/energy
Industrial	www.ti.com/industrial
Medical	www.ti.com/medical
Security	www.ti.com/security
Space, Avionics and Defense	www.ti.com/space-avionics-defense
Video and Imaging	www.ti.com/video

TI E2E Community

e2e.ti.com

AMEYA360

Components Supply Platform

Authorized Distribution Brand :



Website :

Welcome to visit www.ameya360.com

Contact Us :

➤ Address :

401 Building No.5, JiuGe Business Center, Lane 2301, Yishan Rd
Minhang District, Shanghai , China

➤ Sales :

Direct +86 (21) 6401-6692

Email amall@ameya360.com

QQ 800077892

Skype [ameyasales1](#) [ameyasales2](#)

➤ Customer Service :

Email service@ameya360.com

➤ Partnership :

Tel +86 (21) 64016692-8333

Email mkt@ameya360.com