

PART NUMBER CODING

MATERIAL (INSULATOR/CONTACT)

- R = BLACK, PPS/PHOSPHOR BRONZE**
OPERATING TEMP: -65°C TO +125°C
PROCESSING TEMP: 260°C FOR 120 SECS MAX
- G = BLACK, PA9T/PHOSPHOR BRONZE**
OPERATING TEMP: -65°C TO +125°C
PROCESSING TEMP: 260°C FOR 20 SECS MAX
- A = BLACK, PPS/BERYLLIUM COPPER**
OPERATING TEMP: -65°C TO +150°C
PROCESSING TEMP: 260°C FOR 120 SECS MAX
- J = BLACK, PA9T/BERYLLIUM COPPER**
OPERATING TEMP: -65°C TO +150°C
PROCESSING TEMP: 260°C FOR 20 SECS MAX

NUMBER OF POSITIONS (CONTACTS PER ROW)

PLATING

ALL PLATINGS ARE LEAD FREE AND HAVE .000050" NICKEL UNDERPLATE

- | | |
|-------------------|--------------------------|
| CONTACT SURFACE | TERMINATION |
| B = .000010" GOLD | .000100" PURE TIN, MATTE |
| C = .000030" GOLD | .000100" PURE TIN, MATTE |

MOUNTING STYLE

- D = FLUSH MOUNTING
- N = NO MOUNTING EARS
- T = FLUSH MOUNTING, WITH THREADED INSERTS
- R = METAL BOARDLOCKS

REVISIONS				
REV.	ECO. NO	DESCRIPTION	DATE	BY
A	1012	ORIGINAL RELEASE	04/28/06	HT
B	1743	UPDATE DWG FORMAT TABULATE MATERIAL INCORPORATING "E" & "H" TO CODING CHART	9/12/2008	VJ
C	2562	UPDATE RECOMMENDED PCB HOLE TO .030 (WAS .040), STANDOFF ON DWG VIEW, REMOVE 'E' & 'H' MTL OPTION	3/14/2012	JH

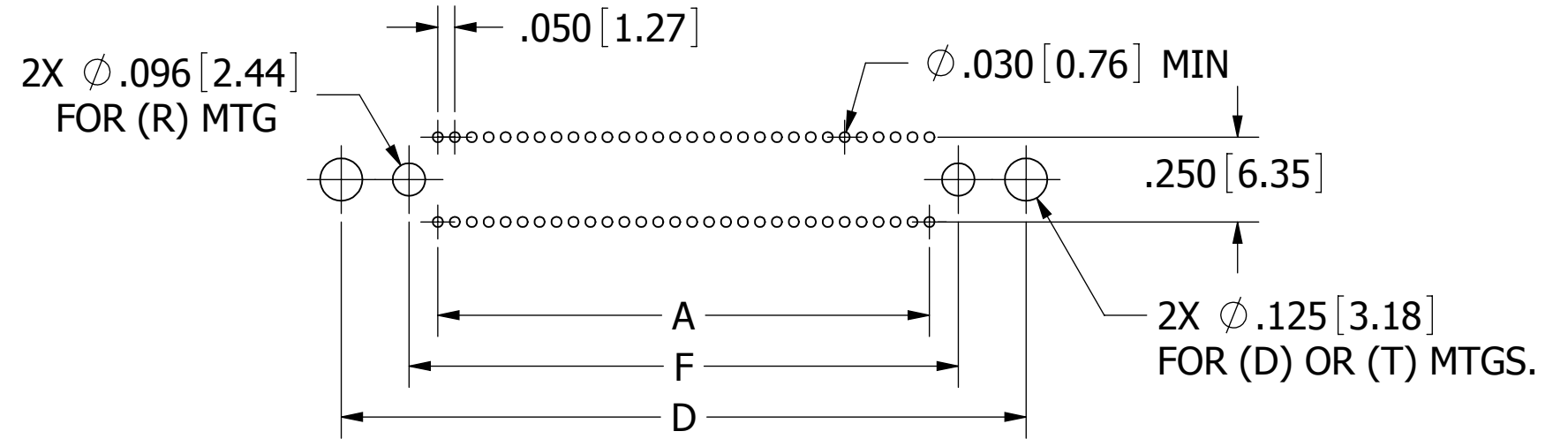
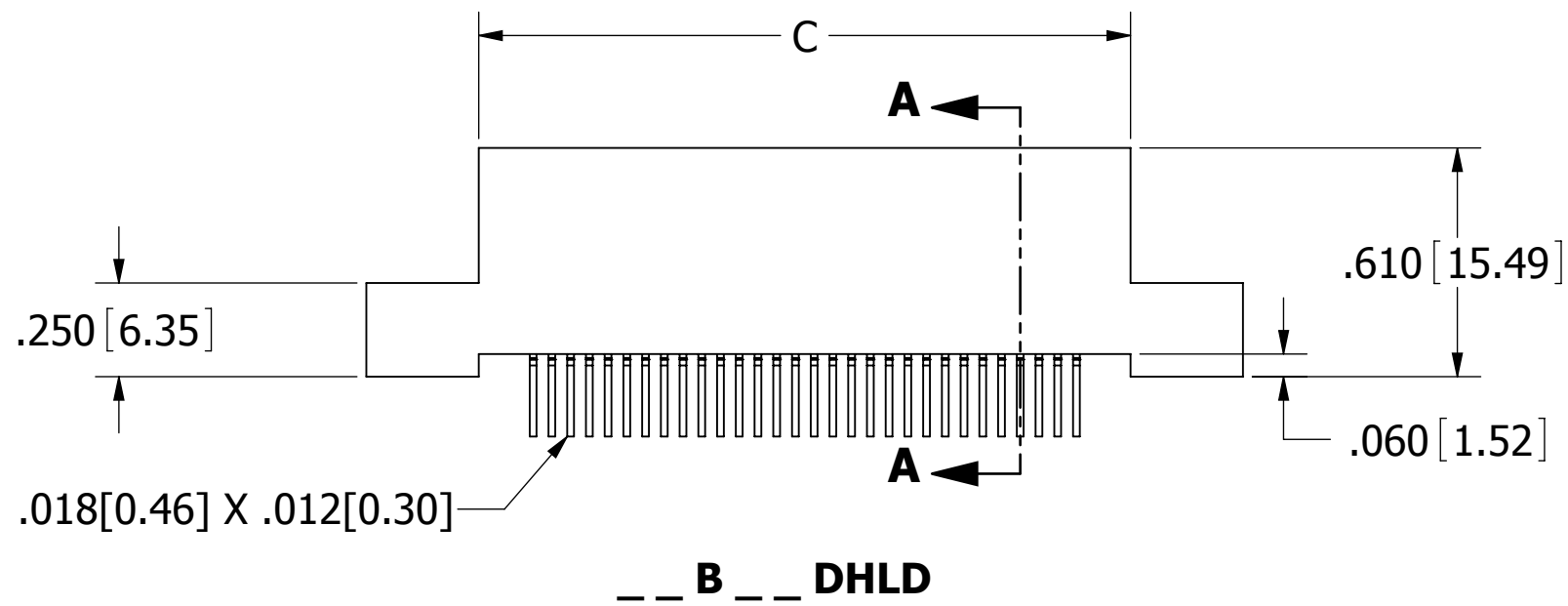
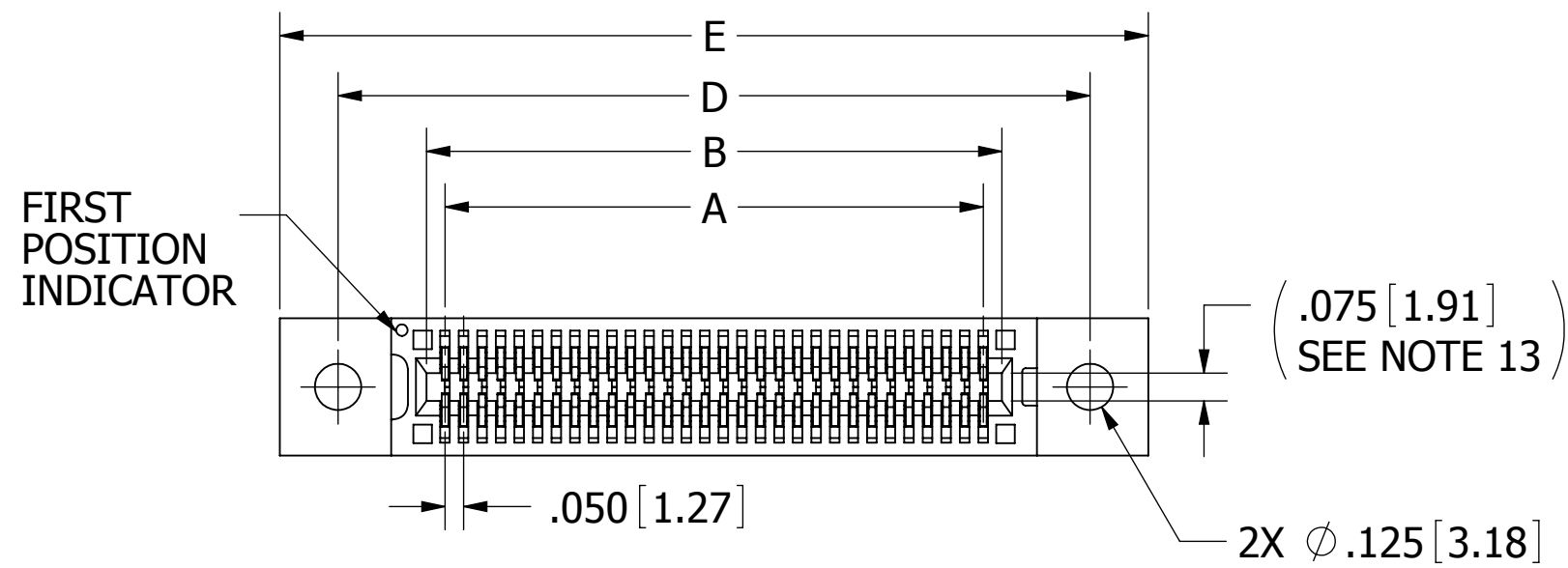

PCB LAYOUT, CONNECTOR SIDE

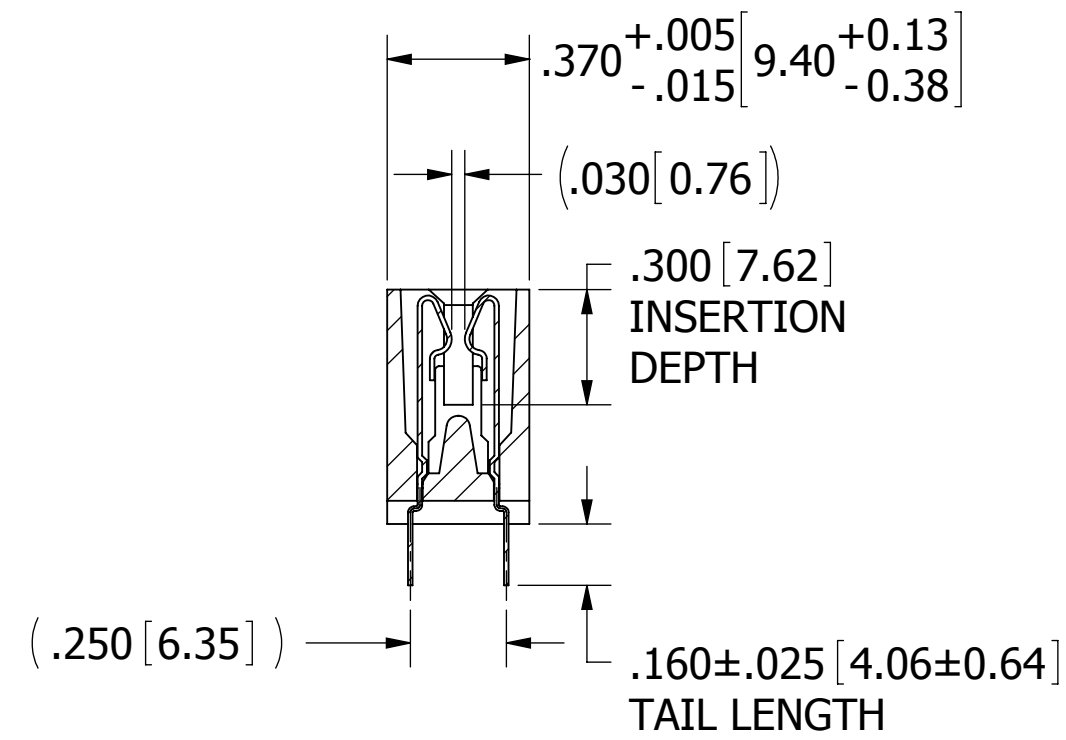

SECTION A-A

- NOTES:**
- INSULATOR MATERIAL: SEE PART NUMBER CODING
 - CONTACT MATERIAL: SEE PART NUMBER CODING
 - PLATING: SEE PART NUMBER CODING
 - OPERATING TEMPERATURE: SEE PART NUMBER CODING
 - PROCESSING TEMP: SEE PART NUMBER CODING
 - UL FLAMMABILITY RATING: 94V-0
 - OPERATING VOLTAGE: 300 VAC MINIMUM AT SEA LEVEL
 - CURRENT RATING: 1 AMP PER CONTACT
 - CONTACT RESISTANCE: 30 MILLI OHMS MAX
 - INSULATION RESISTANCE: 5000 MEGA OHMS
 - DURABILITY: 500 CYCLES MIN
 - CONNECTOR IDENTIFICATION: THE PART SHALL BE MARKED WITH A PART NUMBER AND LOT CODE
 - BOARD THICKNESS ACCOMMODATED: .062 ± .008 [1.57 ± 0.20]
 - INSERTION FORCE: 6 OZ MAX PER CONTACT PAIR WHEN USING A .062 [1.57] TEST BLADE
 - WITHDRAWAL FORCE: 1 OZ MIN PER CONTACT PAIR USING .062 [1.57] PCB



CUSTOMER COPY

UNLESS OTHERWISE SPECIFIED: DIMENSIONS ARE IN INCHES [MM]	DRAWN	DATE	NAME	
		04/28/2006	HT	
TOLERANCES: ANGULAR: ± 1° DECIMALS .XX = ± .02 [.5] .XXX = ± .005 [0.13] .XXXX = ± .0005 [0.013]	THE INFORMATION HEREIN CONTAINS PROPRIETARY INFORMATION OF SULLINS ELECTRONICS AND IS NOT TO BE REPRODUCED, USED OR DISCLOSED TO OTHERS FOR ANY PURPOSE EXCEPT AS SPECIFICALLY AUTHORIZED IN WRITING BY AN OFFICER OF SULLINS ELECTRONICS.			TITLE
				EDGECARD, .050 CC, HP
PART NUMBER				
--- B --- DHL ---				
SIZE	CAGE CODE	DWG. NO.	REV	
C	54453	C10709	C	
SCALE: 2:1		SHEET 1 OF 3		

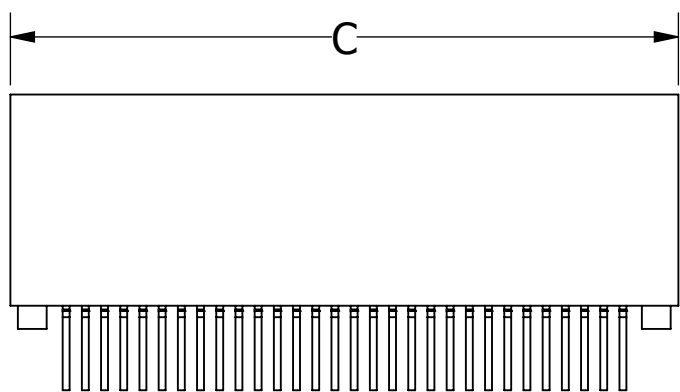
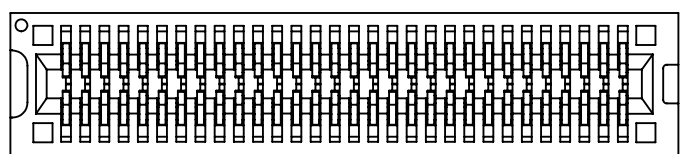

__ B __ DHLN

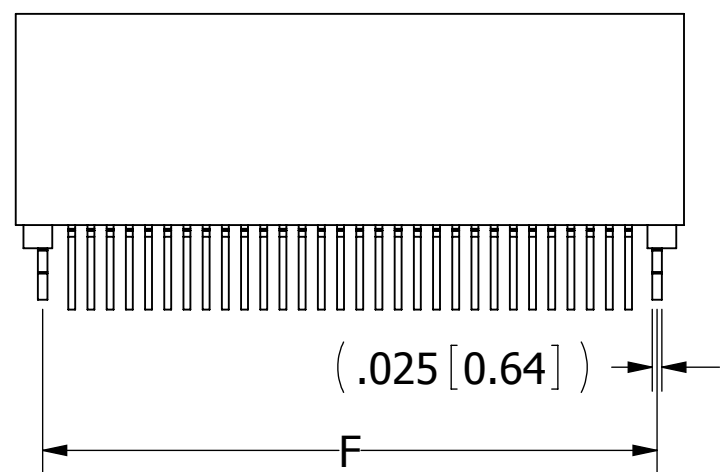
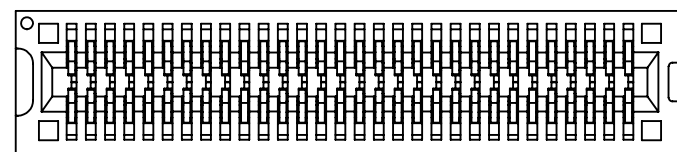

__ B __ DHLR

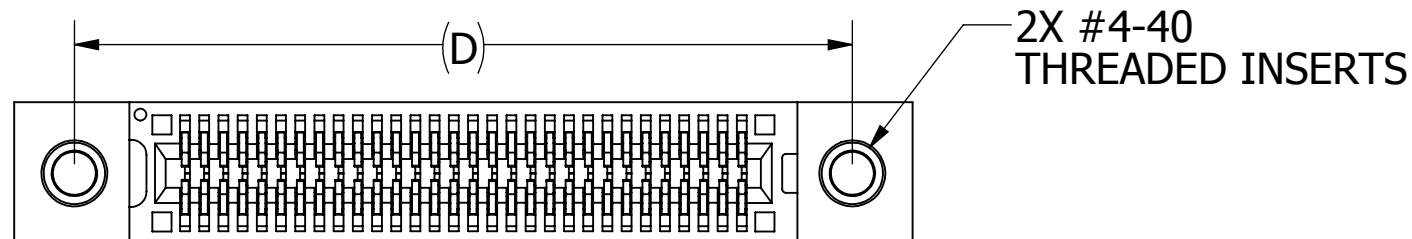
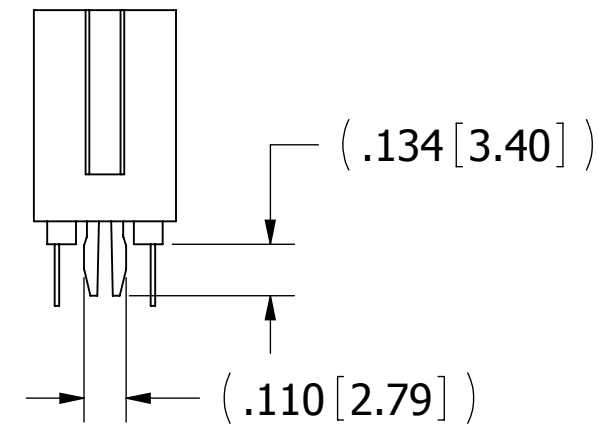

__ B __ DHLT

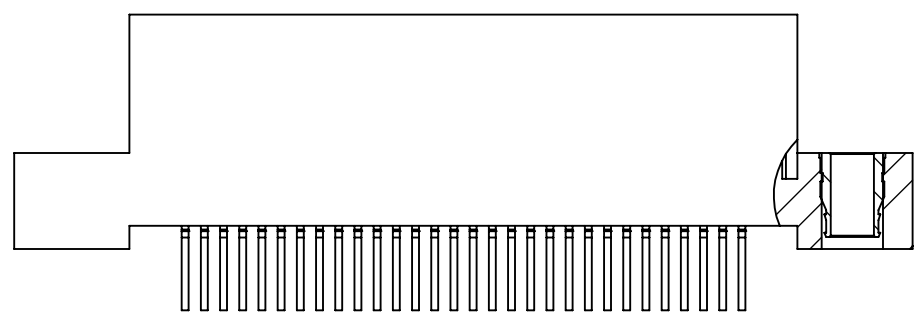

CUSTOMER COPY



UNLESS OTHERWISE SPECIFIED:
DIMENSIONS ARE IN INCHES [MM]

TOLERANCES:
ANGULAR: ± 1°
DECIMALS
.XX = ± .02 [.5]
.XXX = ± .005 [.13]
.XXXX = ± .0005 [.013]

DRAWN	DATE	NAME
	04/28/2006	HT

THE INFORMATION HEREIN CONTAINS PROPRIETARY INFORMATION OF SULLINS ELECTRONICS AND IS NOT TO BE REPRODUCED, USED OR DISCLOSED TO OTHERS FOR ANY PURPOSE EXCEPT AS SPECIFICALLY AUTHORIZED IN WRITING BY AN OFFICER OF SULLINS ELECTRONICS.

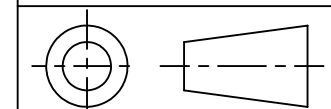

TITLE
EDGE CARD, .050 CC, HP

PART NUMBER
__ B __ DHL __

SIZE	CAGE CODE	DWG. NO.	REV
C	54453	C10709	C

SCALE: 2:1 SHEET 2 OF 3

PART NUMBER	NO OF POS.	A±.005[0.13]		B±.005[0.13]		C±.015[0.38]		D±.010[0.25]		E±.020[0.51]		F±.010[0.25]	
		IN	MM	IN	MM	IN	MM	IN	MM	IN	MM	IN	MM
B05DHL	5	0.200	5.08	0.300	7.62	0.490	12.45	0.776	19.71	1.090	27.69	0.350	8.89
B06DHL	6	0.250	6.35	0.350	8.89	0.540	13.72	0.826	20.98	1.140	28.96	0.400	10.16
B07DHL	7	0.300	7.62	0.400	10.16	0.590	14.99	0.876	22.25	1.190	30.23	0.450	11.43
B08DHL	8	0.350	8.89	0.450	11.43	0.640	16.26	0.926	23.52	1.240	31.50	0.500	12.70
B09DHL	9	0.400	10.16	0.500	12.70	0.690	17.53	0.976	24.79	1.290	32.77	0.550	13.97
B10DHL	10	0.450	11.43	0.550	13.97	0.740	18.80	1.026	26.06	1.340	34.04	0.600	15.24
B11DHL	11	0.500	12.70	0.600	15.24	0.790	20.07	1.076	27.33	1.390	35.31	0.650	16.51
B12DHL	12	0.550	13.97	0.650	16.51	0.840	21.34	1.126	28.60	1.440	36.58	0.700	17.78
B13DHL	13	0.600	15.24	0.700	17.78	0.890	22.61	1.176	29.87	1.490	37.85	0.750	19.05
B14DHL	14	0.650	16.51	0.750	19.05	0.940	23.88	1.226	31.14	1.540	39.12	0.800	20.32
B15DHL	15	0.700	17.78	0.800	20.32	0.990	25.15	1.276	32.41	1.590	40.39	0.850	21.59
B16DHL	16	0.750	19.05	0.850	21.59	1.040	26.42	1.326	33.68	1.640	41.66	0.900	22.86
B17DHL	17	0.800	20.32	0.900	22.86	1.090	27.69	1.376	34.95	1.690	42.93	0.950	24.13
B18DHL	18	0.850	21.59	0.950	24.13	1.140	28.96	1.426	36.22	1.740	44.20	1.000	25.40
B19DHL	19	0.900	22.86	1.000	25.40	1.190	30.23	1.476	37.49	1.790	45.47	1.050	26.67
B20DHL	20	0.950	24.13	1.050	26.67	1.240	31.50	1.526	38.76	1.840	46.74	1.100	27.94
B21DHL	21	1.000	25.40	1.100	27.94	1.290	32.77	1.576	40.03	1.890	48.01	1.150	29.21
B22DHL	22	1.050	26.67	1.150	29.21	1.340	34.04	1.626	41.30	1.940	49.28	1.200	30.48
B23DHL	23	1.100	27.94	1.200	30.48	1.390	35.31	1.676	42.57	1.990	50.55	1.250	31.75
B24DHL	24	1.150	29.21	1.250	31.75	1.440	36.58	1.726	43.84	2.040	51.82	1.300	33.02
B25DHL	25	1.200	30.48	1.300	33.02	1.490	37.85	1.776	45.11	2.090	53.09	1.350	34.29
B26DHL	26	1.250	31.75	1.350	34.29	1.540	39.12	1.826	46.38	2.140	54.36	1.400	35.56
B27DHL	27	1.300	33.02	1.400	35.56	1.590	40.39	1.876	47.65	2.190	55.63	1.450	36.83
B28DHL	28	1.350	34.29	1.450	36.83	1.640	41.66	1.926	48.92	2.240	56.90	1.500	38.10
B29DHL	29	1.400	35.56	1.500	38.10	1.690	42.93	1.976	50.19	2.290	58.17	1.550	39.37
B30DHL	30	1.450	36.83	1.550	39.37	1.740	44.20	2.026	51.46	2.340	59.44	1.600	40.64
B31DHL	31	1.500	38.10	1.600	40.64	1.790	45.47	2.076	52.73	2.390	60.71	1.650	41.91
B32DHL	32	1.550	39.37	1.650	41.91	1.840	46.74	2.126	54.00	2.440	61.98	1.700	43.18
B33DHL	33	1.600	40.64	1.700	43.18	1.890	48.01	2.176	55.27	2.490	63.25	1.750	44.45
B34DHL	34	1.650	41.91	1.750	44.45	1.940	49.28	2.226	56.54	2.540	64.52	1.800	45.72
B35DHL	35	1.700	43.18	1.800	45.72	1.990	50.55	2.276	57.81	2.590	65.79	1.850	46.99
B36DHL	36	1.750	44.45	1.850	46.99	2.040	51.82	2.326	59.08	2.640	67.06	1.900	48.26
B37DHL	37	1.800	45.72	1.900	48.26	2.090	53.09	2.376	60.35	2.690	68.33	1.950	49.53
B38DHL	38	1.850	46.99	1.950	49.53	2.140	54.36	2.426	61.62	2.740	69.60	2.000	50.80
B39DHL	39	1.900	48.26	2.000	50.80	2.190	55.63	2.476	62.89	2.790	70.87	2.050	52.07
B40DHL	40	1.950	49.53	2.050	52.07	2.240	56.90	2.526	64.16	2.840	72.14	2.100	53.34
B41DHL	41	2.000	50.80	2.100	53.34	2.290	58.17	2.576	65.43	2.890	73.41	2.150	54.61
B42DHL	42	2.050	52.07	2.150	54.61	2.340	59.44	2.626	66.70	2.940	74.68	2.200	55.88
B43DHL	43	2.100	53.34	2.200	55.88	2.390	60.71	2.676	67.97	2.990	75.95	2.250	57.15
B44DHL	44	2.150	54.61	2.250	57.15	2.440	61.98	2.726	69.24	3.040	77.22	2.300	58.42
B45DHL	45	2.200	55.88	2.300	58.42	2.490	63.25	2.776	70.51	3.090	78.49	2.350	59.69
B46DHL	46	2.250	57.15	2.350	59.69	2.540	64.52	2.826	71.78	3.140	79.76	2.400	60.96
B47DHL	47	2.300	58.42	2.400	60.96	2.590	65.79	2.876	73.05	3.190	81.03	2.450	62.23
B48DHL	48	2.350	59.69	2.450	62.23	2.640	67.06	2.926	74.32	3.240	82.30	2.500	63.50
B49DHL	49	2.400	60.96	2.500	63.50	2.690	68.33	2.976	75.59	3.290	83.57	2.550	64.77
B50DHL	50	2.450	62.23	2.550	64.77	2.740	69.60	3.026	76.86	3.340	84.84	2.600	66.04
B51DHL	51	2.500	63.50	2.600	66.04	2.790	70.87	3.076	78.13	3.390	86.11	2.650	67.31
B52DHL	52	2.550	64.77	2.650	67.31	2.840	72.14	3.126	79.40	3.440	87.38	2.700	68.58
B53DHL	53	2.600	66.04	2.700	68.58	2.890	73.41	3.176	80.67	3.490	88.65	2.750	69.85
B54DHL	54	2.650	67.31	2.750	69.85	2.940	74.68	3.226	81.94	3.540	89.92	2.800	71.12
B55DHL	55	2.700	68.58	2.800	71.12	2.990	75.95	3.276	83.21	3.590	91.19	2.850	72.39
B56DHL	56	2.750	69.85	2.850	72.39	3.040	77.22	3.326	84.48	3.640	92.46	2.900	73.66
B57DHL	57	2.800	71.12	2.900	73.66	3.090	78.49	3.376	85.75	3.690	93.73	2.950	74.93
B58DHL	58	2.850	72.39	2.950	74.93	3.140	79.76	3.426	87.02	3.740	95.00	3.000	76.20
B59DHL	59	2.900	73.66	3.000	76.20	3.190	81.03	3.476	88.29	3.790	96.27	3.050	77.47
B60DHL	60	2.950	74.93	3.050	77.47	3.240	82.30	3.526	89.56	3.840	97.54	3.100	78.74
B61DHL	61	3.000	76.20	3.100	78.74	3.290	83.57	3.576	90.83	3.890	98.81	3.150	80.01
B62DHL	62	3.050	77.47	3.150	80.01	3.340	84.84	3.626	92.10	3.940	100.08	3.200	81.28
B63DHL	63	3.100	78.74	3.200	81.28	3.390	86.11	3.676	93.37	3.990	101.35	3.250	82.55
B64DHL	64	3.150	80.01	3.250	82.55	3.440	87.38	3.726	94.64	4.040	102.62	3.300	83.82
B65DHL	65	3.200	81.28	3.300	83.82	3.490	88.65	3.776	95.91	4.090	103.89	3.350	85.09

PART NUMBER	NO OF POS.	A±.005[0.13]		B±.005[0.13]		C±.015[0.38]		D±.010[0.25]		E±.020[0.51]		F±.010[0.25]	
		IN	MM	IN	MM	IN	MM	IN	MM	IN	MM	IN	MM
B66DHL	66	3.250	82.55	3.350	85.09	3.540	89.92	3.826	97.18	4.140	105.16	3.400	86.36
B67DHL	67	3.300	83.82	3.400	86.36	3.590	91.19	3.876	98.45	4.190	106.43	3.450	87.63
B68DHL	68	3.350	85.09	3.450	87.63	3.640	92.46	3.926	99.72	4.240	107.70	3.500	88.90
B69DHL	69	3.400	86.36	3.500	88.90	3.690	93.73	3.976	100.99	4.290	108.97	3.550	90.17
B70DHL	70	3.450	87.63	3.550	90.17	3.740	95.00	4.026	102.26	4.340	110.24	3.600	91.44
B71DHL	71	3.500	88.90	3.600	91.44	3.790	96.27	4.076	103.53	4.390	111.51	3.650	92.71
B72DHL	72	3.550	90.17	3.650	92.71	3.840	97.54	4.126	104.80	4.440	112.78	3.700	93.98
B73DHL	73	3.600	91.44	3.700	93.98	3.890	98.81	4.176	106.07	4.490	114.05	3.750	95.25
B74DHL	74	3.650	92.71	3.750	95.25	3.940	100.08	4.226	107.34	4.540	115.32	3.800	96.52
B75DHL	75	3.700	93.98	3.800	96.52	3.990	101.35	4.276	108.61	4.590	116.59	3.850	97.79
B76DHL	76	3.750	95.25	3.850	97.79	4.040	102.62	4.326	109.88	4.640	117.86	3.900	99.06
B77DHL	77	3.800	96.52	3.900	99.06	4.090	103.89	4.376	111.15	4.690	119.13	3.950	100.33
B78DHL	78	3.850	97.79	3.950	100.33	4.140	105.16	4.426	112.42	4.740	120.40	4.000	101.60
B79DHL	79	3.900	99.06	4.000	101.60	4.190	106.43	4.476	113.69	4.790	121.67	4.050	102.87
B80DHL	80	3.950	100.33	4.050	102.87	4.240	107.70	4.526	114.96	4.840	122.94	4.100	104.14
B81DHL	81	4.000	101.60	4.100	104.14	4.290	108.97	4.576	116.23	4.890	124.21	4.150	105.41
B82DHL	82	4.050	102.87	4.150	105.41	4.340	110.24	4.626	117.50	4.940	125.48	4.200	106.68
B83DHL	83	4.100	104.14	4.200	106.68	4.390	111.51	4.676	118.77	4.990	126.75	4.250	107.95
B84DHL	84	4.150	105.41	4.250	107.95	4.440	112.78	4.726	120.04	5.040	128.02	4.300	109.22
B85DHL	85	4.200	106.68	4.300	109.22	4.490	114.05	4.776	121.31	5.090	129.29	4.350	110.49
B86DHL	86	4.250	107.95	4.350	110.49	4.540	115.32	4.826	122.58	5.140	130.56	4.400	111.76
B87DHL	87	4.300	109.22	4.400	111.76	4.590	116.59	4.876	123.85	5.190	131.83	4.450	113.03
B88DHL	88	4.35											

Authorized Distribution Brand :



Website :

Welcome to visit www.ameya360.com

Contact Us :

➤ Address :

401 Building No.5, JiuGe Business Center, Lane 2301, Yishan Rd
Minhang District, Shanghai , China

➤ Sales :

Direct +86 (21) 6401-6692

Email amall@ameya360.com

QQ 800077892

Skype ameyasales1 ameyasales2

➤ Customer Service :

Email service@ameya360.com

➤ Partnership :

Tel +86 (21) 64016692-8333

Email mkt@ameya360.com