

THIS DOCUMENT IS THE PROPERTY OF
KEYSTONE ELECTRONICS CORP. AND
SHALL NOT BE REPRODUCED, DISTRIBUTED
OR USED AS A BASIS FOR MANUFACTURE
WITHOUT PRIOR WRITTEN PERMISSION
FROM KEYSTONE ELECTRONICS CORP.

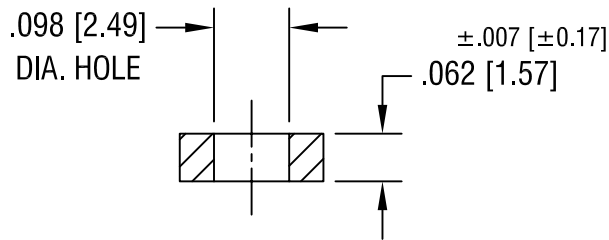
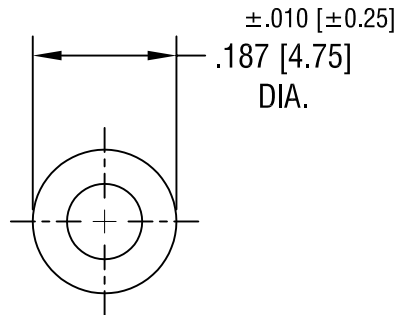

KEYSTONE ELECTRONICS CORP.

ASTORIA, N.Y. 11105-2017

PART NAME

FLAT WASHER

MATERIAL

.062 [1.57] TH'K NYLON

FINISH

-

DRN BY

BOONE

DATE

8.26.82

APP'D

LN

SCALE

4X

9.15.94

CHANGE AS PER ECR 94-053

A

TOLERANCES

INCH [MM]

CODE

DWG NO.

DECIMAL ±.005 [±0.15]

C/M

ANGULAR ± 1°
UNLESS OTHERWISE SPECIFIED

3356

DATE

DESCRIPTION

REV.

AMEYA360

Components Supply Platform

Authorized Distribution Brand :



Website :

Welcome to visit www.ameya360.com

Contact Us :

➤ Address :

401 Building No.5, JiuGe Business Center, Lane 2301, Yishan Rd
Minhang District, Shanghai , China

➤ Sales :

Direct +86 (21) 6401-6692

Email amall@ameya360.com

QQ 800077892

Skype [ameyasales1](#) [ameyasales2](#)

➤ Customer Service :

Email service@ameya360.com

➤ Partnership :

Tel +86 (21) 64016692-8333

Email mkt@ameya360.com