

# 2.5 V or 3.3 V, 10–220 MHz, Low Jitter, 9-Output Zero Delay Buffer

## Features

- 10 MHz to 220 MHz maximum operating range
- Zero input-output propagation delay, adjustable by loading on CLKOUT pin
- Multiple low-skew outputs
  - 45 ps typical output-output skew
  - One input drives nine outputs, grouped as 4 + 4 + 1
- 25 ps typical cycle-to-cycle jitter
- 15 ps typical period jitter
- Standard and High drive strength options
- Available in space-saving 16-pin 150-mil small outline integrated circuit (SOIC) or 4.4-mm thin shrunk small outline package (TSSOP) packages
- 3.3 V or 2.5 V operation
- Industrial temperature available

## Functional Description

The CY23EP09 is a 2.5 V or 3.3 V zero delay buffer designed to distribute high-speed clocks and is available in a 16-pin SOIC or TSSOP package. The -1H version operates up to 220 (200) MHz frequencies at 3.3 V (2.5 V), and has higher drive than the -1 devices. All parts have on-chip PLLs that lock to an input clock on the REF pin. The phase-locked loop (PLL) feedback is on-chip and is obtained from the CLKOUT pad.

There are two banks of four outputs each, which can be controlled by the Select inputs as shown in the “Select Input Decoding” table on page 4. If all output clocks are not required, BankB can be three-stated. The select inputs also allow the input clock to be directly applied to the outputs for chip and system testing purposes.

The PLL enters a power-down mode when there are no rising edges on the REF input (less than ~2 MHz). In this state, the outputs are three-stated and the PLL is turned off, resulting in less than 25  $\mu$ A of current draw.

In the special case when S2:S1 is 1:0, the PLL is bypassed and REF is output from DC to the maximum allowable frequency. The part behaves like a non-zero delay buffer in this mode, and the outputs are not tri-stated.

The CY23EP09 is available in different configurations, as shown in the Ordering Information table. The CY23EP09-1 is the base part. The CY23EP09-1H is the high-drive version of the -1, and its rise and fall times are much faster than the -1.

These parts are not intended for 5 V input-tolerant applications  
For a complete list of related documentation, click [here](#).

## Block Diagram

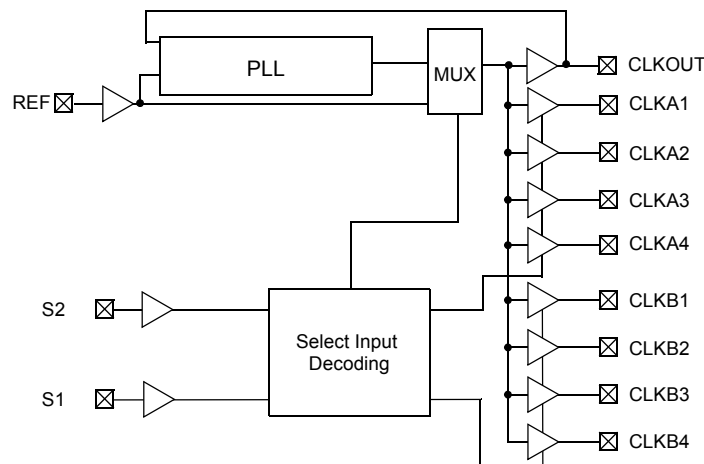

## Contents

<b>Pin Configuration</b> .....	<b>3</b>	<b>Package Diagrams</b> .....	<b>16</b>
<b>Pin Definitions</b> .....	<b>3</b>	<b>Acronyms</b> .....	<b>17</b>
<b>Select Input Decoding</b> .....	<b>4</b>	<b>Document Conventions</b> .....	<b>17</b>
<b>Zero Delay and Skew Control</b> .....	<b>4</b>	Units of Measure .....	17
<b>Absolute Maximum Conditions</b> .....	<b>5</b>	<b>Document History Page</b> .....	<b>18</b>
<b>Operating Conditions</b> .....	<b>5</b>	<b>Sales, Solutions, and Legal Information</b> .....	<b>19</b>
<b>Electrical Specifications</b> .....	<b>6</b>	Worldwide Sales and Design Support .....	19
<b>Electrical Specifications</b> .....	<b>6</b>	Products .....	19
<b>Electrical Specifications</b> .....	<b>7</b>	PSoC® Solutions .....	19
<b>Switching Waveforms</b> .....	<b>9</b>	Cypress Developer Community .....	19
<b>Test Circuits</b> .....	<b>10</b>	Technical Support .....	19
<b>Supplemental Parametric Information</b> .....	<b>11</b>		
<b>Ordering Information</b> .....	<b>15</b>		
Ordering Code Definitions .....	15		

## Pin Configuration

Figure 1. 16-pin SOIC or TSSOP pinout (Top View)

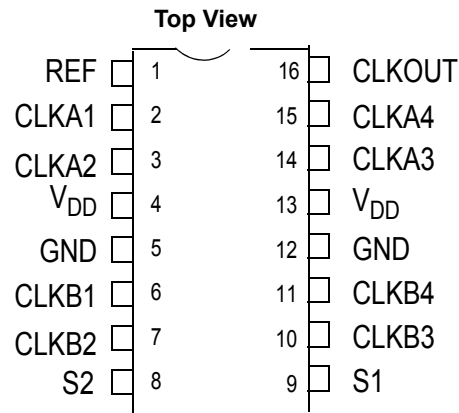

## Pin Definitions

Pin No.	Signal	Description
1	REF <sup>[1]</sup>	Input reference frequency
2	CLKA1 <sup>[2]</sup>	Buffered clock output, Bank A
3	CLKA2 <sup>[2]</sup>	Buffered clock output, Bank A
4	V <sub>DD</sub>	3.3 V or 2.5 V supply
5	GND	Ground
6	CLKB1 <sup>[2]</sup>	Buffered clock output, Bank B
7	CLKB2 <sup>[2]</sup>	Buffered clock output, Bank B
8	S2 <sup>[3]</sup>	Select input, bit 2
9	S1 <sup>[3]</sup>	Select input, bit 1
10	CLKB3 <sup>[2]</sup>	Buffered clock output, Bank B
11	CLKB4 <sup>[2]</sup>	Buffered clock output, Bank B
12	GND	Ground
13	V <sub>DD</sub>	3.3 V or 2.5 V supply
14	CLKA3 <sup>[2]</sup>	Buffered clock output, Bank A
15	CLKA4 <sup>[2]</sup>	Buffered clock output, Bank A
16	CLKOUT <sup>[2]</sup>	Buffered output, internal feedback on this pin

### Notes

1. Weak pull-down.
2. Weak pull-down on all outputs.
3. Weak pull-ups on these inputs.

## Select Input Decoding

S2	S1	CLOCK A1–A4	CLOCK B1–B4	CLKOUT <sup>[4]</sup>	Output Source	PLL Shutdown
0	0	Three-state	Three-state	Driven	PLL	N
0	1	Driven	Three-state	Driven	PLL	N
1	0	Driven	Driven	Driven	Reference	Y
1	1	Driven	Driven	Driven	PLL	N

## Zero Delay and Skew Control

All outputs should be uniformly loaded to achieve Zero Delay between the input and output. Since the CLKOUT pin is the internal feedback to the PLL, its relative loading can adjust the input-output delay.

The output driving the CLKOUT pin will be driving a total load of 5 pF plus any additional load externally connected to this pin. For

applications requiring zero input-output delay, the total load on each output pin (including CLKOUT) must be the same. If input-output delay adjustments are required, the CLKOUT load may be changed to vary the delay between the REF input and remaining outputs.

For zero output-output skew, be sure to load all outputs equally. For further information refer to the application note entitled “CY2305 and CY2309 as PCI and SDRAM Buffers”.

### Note

4. This output is driven and has an internal feedback for the PLL. The load on this output can be adjusted to change the skew between the reference and output.

**Absolute Maximum Conditions**

Supply voltage to ground potential .....	-0.5 V to 4.6 V	Storage temperature .....	-65 °C to 150 °C
DC input voltage .....	$V_{SS} - 0.5$ V to 4.6 V	Junction temperature .....	150 °C
		Static discharge voltage (per MIL-STD-883, Method 3015) .....	> 2000 V

**Operating Conditions**

Parameter	Description	Min	Max	Unit
$V_{DD3.3}$	3.3 V supply voltage	3.0	3.6	V
$V_{DD2.5}$	2.5 V supply voltage	2.3	2.7	V
$T_A$	Operating temperature (ambient temperature)—commercial	0	70	°C
	Operating temperature (ambient temperature)—industrial	-40	85	°C
$C_L$ <sup>[5]</sup>	Load capacitance, <100 MHz, 3.3 V	-	30	pF
	Load capacitance, <100 MHz, 2.5 V with High drive	-	30	pF
	Load capacitance, <133.3 MHz, 3.3 V	-	22	pF
	Load capacitance, <133.3 MHz, 2.5 V with High drive	-	22	pF
	Load capacitance, <133.3 MHz, 2.5 V with Standard drive	-	15	pF
	Load capacitance, >133.3 MHz, 3.3 V	-	15	pF
	Load capacitance, >133.3 MHz, 2.5 V with High drive	-	15	pF
$C_{IN}$	Input capacitance <sup>[6]</sup>	-	5	pF
BW	Closed-loop bandwidth (typical), 3.3 V	1–1.5		MHz
	Closed-loop bandwidth (typical), 2.5 V	0.8		MHz
$R_{OUT}$	Output impedance (typical), 3.3 V High drive	29		$\Omega$
	Output impedance (typical), 3.3 V Standard drive	41		$\Omega$
	Output impedance (typical), 2.5 V High drive	37		$\Omega$
	Output impedance (typical), 2.5 V Standard drive	41		$\Omega$
$t_{PU}$	Power-up time for all VDD's to reach minimum specified voltage (power ramps must be monotonic)	0.01	50	ms
Theta Ja <sup>[7]</sup>	Dissipation, Junction to ambient, 16-pin SOIC	95		°C/W
	Dissipation, Junction to ambient, 16-pin TSSOP	100		°C/W
Theta Jc <sup>[7]</sup>	Dissipation, Junction to case, 16-pin SOIC	58		°C/W
	Dissipation, Junction to case, 16-pin TSSOP	39		°C/W

**Notes**

- Applies to Test Circuit #1.
- Applies to both REF Clock and internal feedback path on CLKOUT.
- Theta Ja, EIA JEDEC 51 test board conditions, 2S2P; Theta Jc Mil-Spec 883E Method 1012.1.

## Electrical Specifications

### 3.3 V DC

Parameter	Description	Test Conditions	Min	Max	Unit
V <sub>DD</sub>	Supply voltage		3.0	3.6	V
V <sub>IL</sub>	Input LOW voltage		–	0.8	V
V <sub>IH</sub>	Input HIGH voltage		2.0	V <sub>DD</sub> + 0.3	V
I <sub>IL</sub>	Input leakage current	0 < V <sub>IN</sub> < V <sub>IL</sub>	–	±10	μA
I <sub>IH</sub>	Input HIGH current	V <sub>IN</sub> = V <sub>DD</sub>	–	100	μA
V <sub>OL</sub>	Output LOW voltage	I <sub>OL</sub> = 8 mA (standard drive)	–	0.4	V
		I <sub>OL</sub> = 12 mA (High drive)	–	0.4	V
V <sub>OH</sub>	Output HIGH voltage	I <sub>OH</sub> = –8 mA (standard drive)	2.4	–	V
		I <sub>OH</sub> = –12 mA (High drive)	2.4	–	V
I <sub>DD</sub> (PD mode)	Power down supply current	REF = 0 MHz (Commercial)	–	12	μA
		REF = 0 MHz (Industrial)	–	25	μA
I <sub>DD</sub>	Supply current	Unloaded outputs, 66-MHz REF	–	30	mA

## Electrical Specifications

### 2.5 V DC

Parameter	Description	Test Conditions	Min	Max	Unit
V <sub>DD</sub>	Supply voltage		2.3	2.7	V
V <sub>IL</sub>	Input LOW voltage		–	0.7	V
V <sub>IH</sub>	Input HIGH voltage		1.7	V <sub>DD</sub> + 0.3	V
I <sub>IL</sub>	Input leakage current	0 < V <sub>IN</sub> < V <sub>DD</sub>	–	10	μA
I <sub>IH</sub>	Input HIGH current	V <sub>IN</sub> = V <sub>DD</sub>	–	100	μA
V <sub>OL</sub>	Output LOW voltage	I <sub>OL</sub> = 8 mA (Standard drive)	–	0.5	V
		I <sub>OL</sub> = 12 mA (High drive)	–	0.5	V
V <sub>OH</sub>	Output HIGH voltage	I <sub>OH</sub> = –8 mA (Standard drive)	V <sub>DD</sub> – 0.6	–	V
		I <sub>OH</sub> = –12 mA (High drive)	V <sub>DD</sub> – 0.6	–	V
I <sub>DD</sub> (PD mode)	Power down supply current	REF = 0 MHz (Commercial)	–	12	μA
		REF = 0 MHz (Industrial)	–	25	μA
I <sub>DD</sub>	Supply current	Unloaded outputs, 66-MHz REF	–	45	mA

## Electrical Specifications

### 3.3 V and 2.5 V AC

Parameter	Description	Test Conditions	Min	Typ	Max	Unit
1/t <sub>1</sub>	Maximum frequency <sup>[8]</sup> (input/output)	3.3 V High drive	10	–	220	MHz
		3.3 V Standard drive	10	–	167	MHz
		2.5 V High drive	10	–	200	MHz
		2.5 V Standard drive	10	–	133	MHz
T <sub>IDC</sub>	Input duty cycle	<133.3 MHz	25	–	75	%
		>133.3 MHz	40	–	60	%
t <sub>2</sub> ÷ t <sub>1</sub>	Output duty cycle <sup>[9]</sup>	<133.3 MHz	47	–	53	%
		>133.3 MHz	45	–	55	%
t <sub>3</sub> , t <sub>4</sub>	Rise, fall time (3.3 V) <sup>[9]</sup>	Std drive, CL = 30 pF, <100 MHz	–	–	1.6	ns
		Std drive, CL = 22 pF, <133.3 MHz	–	–	1.6	ns
		Std drive, CL = 15 pF, <167 MHz	–	–	0.6	ns
		High drive, CL = 30 pF, <100 MHz	–	–	1.2	ns
		High drive, CL = 22 pF, <133.3 MHz	–	–	1.2	ns
		High drive, CL = 15 pF, >133.3 MHz	–	–	0.5	ns
t <sub>3</sub> , t <sub>4</sub>	Rise, fall time (2.5 V) <sup>[9]</sup>	Std drive, CL = 15 pF, <133.33 MHz	–	–	1.5	ns
		High drive, CL = 30 pF, <100 MHz	–	–	2.1	ns
		High drive, CL = 22 pF, <133.3 MHz	–	–	1.3	ns
		High drive, CL = 15 pF, >133.3 MHz	–	–	1.2	ns
t <sub>5</sub>	Output to output skew <sup>[9]</sup>	All outputs equally loaded, 3.3 V supply, 2.5 supply standard drive	–	45	100	ps
		All outputs equally loaded, 2.5 V supply high drive	–	–	110	ps
t <sub>6</sub>	Delay, REF rising edge to CLKOUT rising edge <sup>[9]</sup>	PLL Bypass mode	1.5	–	4.4	ns
		PLL enabled @ 3.3 V	–100	–	100	ps
		PLL enabled @2.5 V	–200	–	200	ps
t <sub>7</sub>	Part to part skew <sup>[9]</sup>	Measured at V <sub>DD</sub> /2. Any output to any output, 3.3 V sup- ply	–	–	±150	ps
		Measured at V <sub>DD</sub> /2. Any output to any output, 2.5 V sup- ply	–	–	±300	ps
t <sub>LOCK</sub>	PLL lock time <sup>[9]</sup>	Stable power supply, valid clocks presented on REF and CLKOUT pins	–	–	1.0	ms

**Notes**

8. For the given maximum loading conditions. See C<sub>1</sub> in Operating Conditions Table.  
9. Parameter is guaranteed by design and characterization. Not 100% tested in production.

**Electrical Specifications** (continued)

3.3 V and 2.5 V AC

Parameter	Description	Test Conditions	Min	Typ	Max	Unit
T <sub>JCC</sub> <sup>[10, 11]</sup>	Cycle-to-cycle jitter, peak	3.3 V supply, >66 MHz, <15 pF	–	25	55	ps
		3.3 V supply, >66 MHz, <30 pF, standard drive	–	65	125	ps
		3.3 V supply, >66 MHz, <30 pF, high drive	–	53	100	ps
		2.5 V supply, >66 MHz, <15 pF, standard drive	–	35	95	ps
		2.5 V supply, >66 MHz, <15 pF, high drive	–	30	65	ps
		2.5 V supply, >66 MHz, <30 pF, high drive	–	75	145	ps
		S2:S1 = 1:0 mode, 3.3 V, <15 pF, standard drive	–	16	–	ps
		S2:S1 = 1:0 mode, 3.3 V, <15 pF, high drive	–	14	–	ps
		S2:S1 = 1:0 mode, 2.5 V, <15 pF, standard drive	–	23	–	ps
		S2:S1 = 1:0 mode, 2.5 V, <15 pF, high drive	–	22	–	ps
T <sub>PER</sub> <sup>[10, 11]</sup>	Period jitter, peak	3.3 V supply, 66–100 MHz, <15 pF	–	20	75	ps
		3.3 V supply, >100 MHz, <15 pF	–	15	45	ps
		3.3 V supply, >66 MHz, <30 pF, standard drive	–	40	100	ps
		3.3 V supply, >66 MHz, <30 pF, high drive	–	30	70	ps
		2.5 V supply, >66 MHz, <15 pF, standard drive	–	25	60	ps
		2.5 V supply, 66–100 MHz, <15 pF, high drive	–	25	60	ps
		2.5 V supply, >100 MHz, <15 pF, high drive	–	15	45	ps
		S2:S1 = 1:0 mode, 3.3 V, <15 pF, standard drive	–	28	–	ps
		S2:S1 = 1:0 mode, 3.3 V, <15 pF, high drive	–	24	–	ps
		S2:S1 = 1:0 mode, 2.5 V, <15 pF, standard drive	–	40	–	ps
		S2:S1 = 1:0 mode, 2.5 V, <15 pF, high drive	–	37	–	ps

**Notes**

10. Parameter is guaranteed by design and characterization. Not 100% tested in production.

11. Typical jitter is measured at 3.3 V or 2.5 V, 29 °C, with all outputs driven into the maximum specified load. Further information regarding jitter specifications may be found in the application note "Understanding Data Sheet Jitter Specifications for Cypress Clock Products."

## Switching Waveforms

Figure 2. Duty Cycle Timing

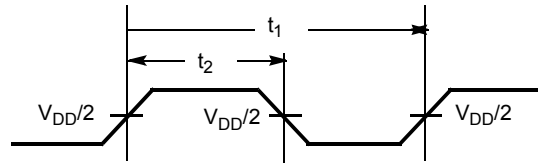

Figure 3. All Outputs Rise/Fall Time

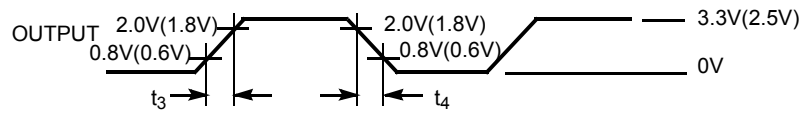

Figure 4. Output-Output Skew

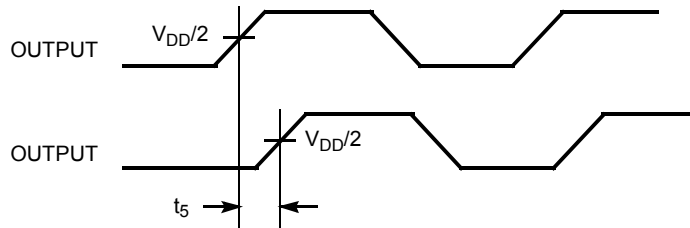

Figure 5. Input-Output Propagation Delay

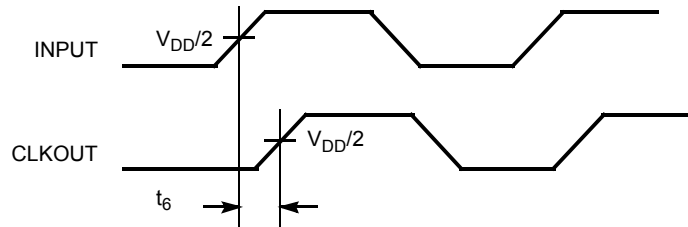
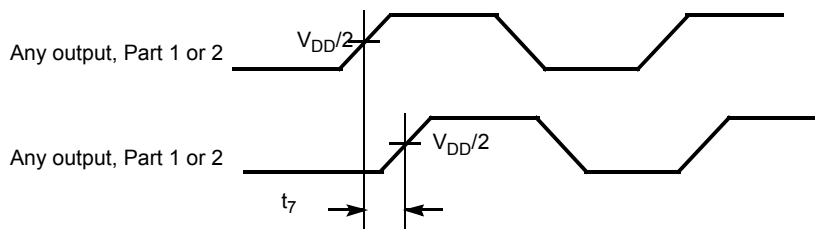
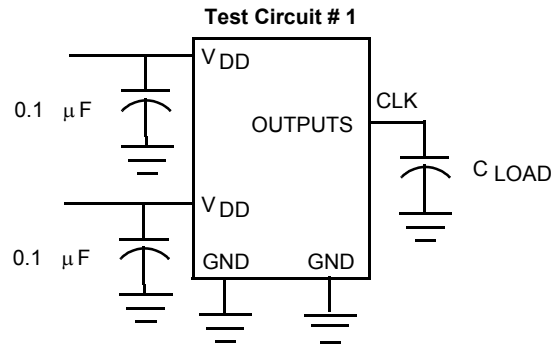

Figure 6. Part-Part Skew



## Test Circuits

Figure 7. Test Circuit



### Supplemental Parametric Information

Figure 8. 2.5 V Typical Room Temperature Graph for REF Input to CLKA/CLKB Delay Versus Loading Difference between CLKOUT and CLKA/CLKB

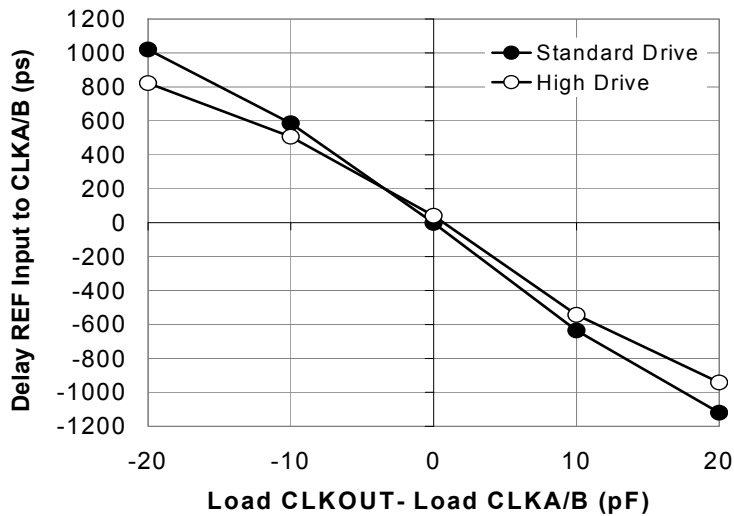

Data is shown for 66 MHz. Delay is a weak function of frequency.

Figure 9. 3.3 V Typical Room Temperature Graph for REF Input to CLKA/CLKB Delay Versus Loading Difference between CLKOUT and CLKA/CLKB

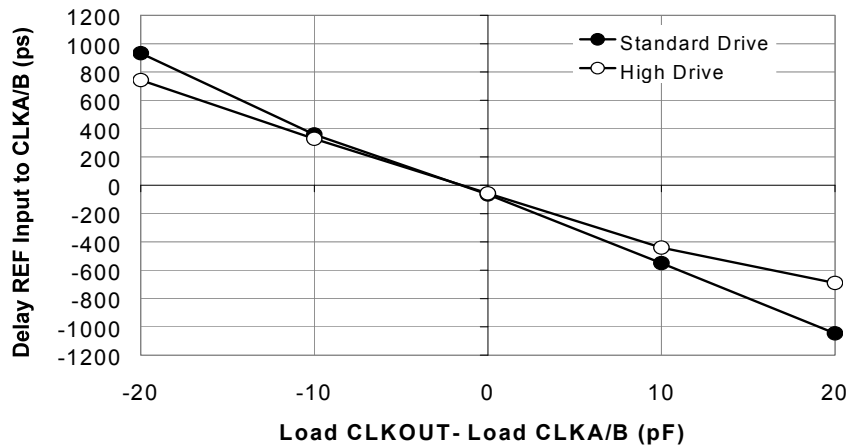

Data is shown for 66 MHz. Delay is a weak function of frequency.

Supplemental Parametric Information (continued)

Figure 10. 3.6 V Measured Supply Current versus Frequency, Drive Strength, Loading, and Temperature

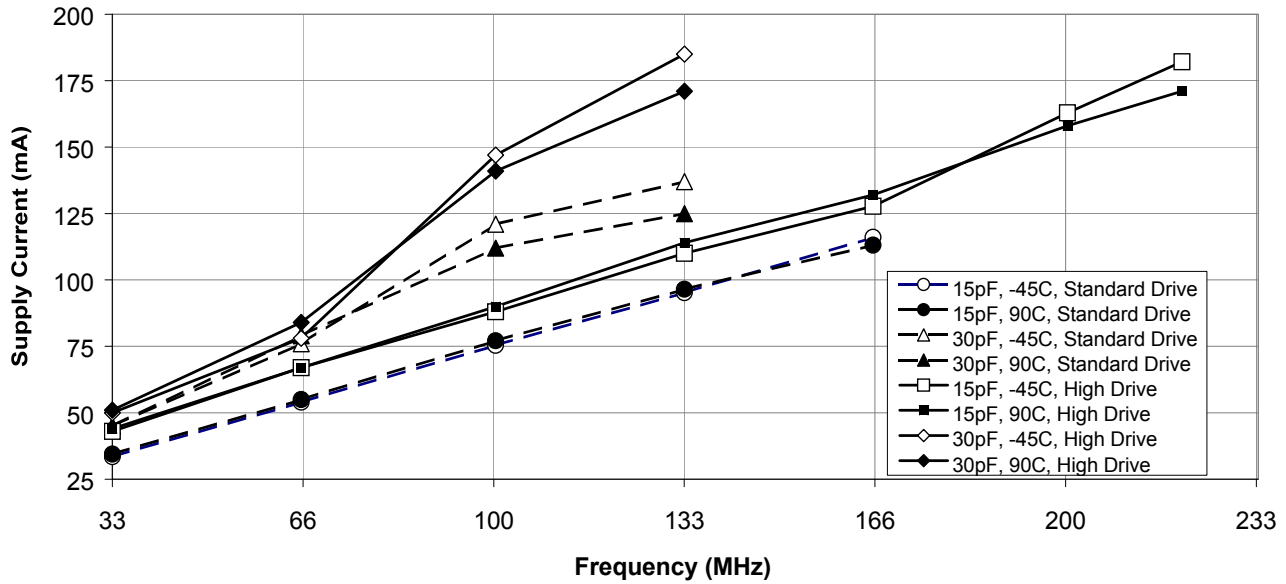

Note that the 30-pF data above 100 MHz is beyond the data sheet specification of 22 pF.

Figure 11. 2.7 V Measured Supply Current Versus Frequency, Drive Strength, Loading, and Temperature

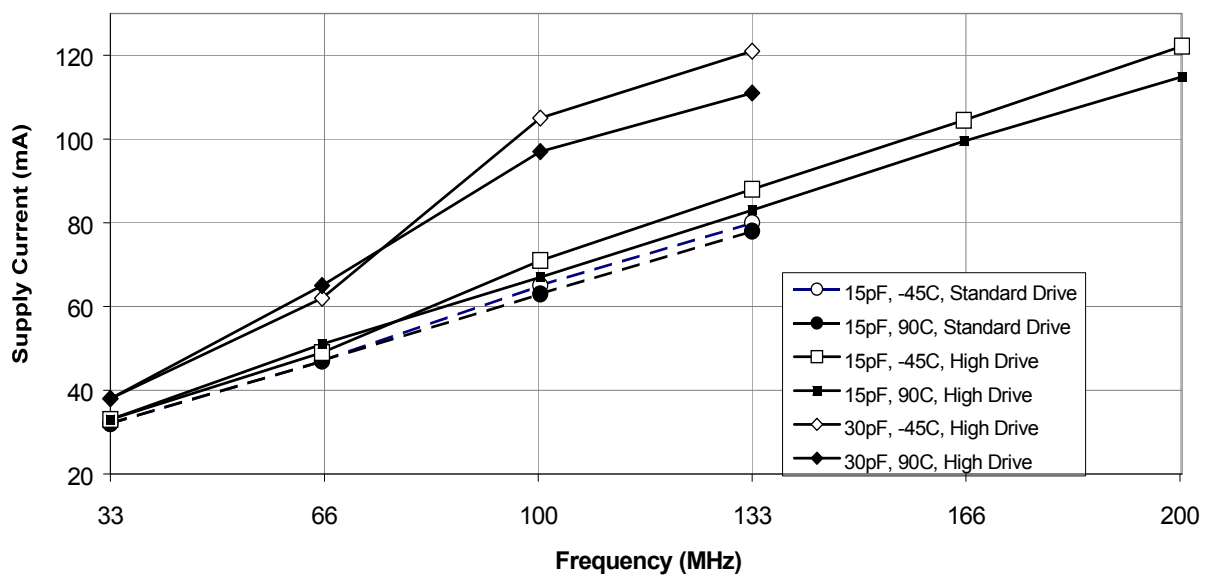

Note that the 30-pF high-drive data above 100bMHz is beyond the data sheet specification of 22 pF.

Supplemental Parametric Information (continued)

Figure 12. Typical 3.3 V Measured Cycle-to-cycle Jitter at 29 °C, versus Frequency, Drive Strength, and Loading

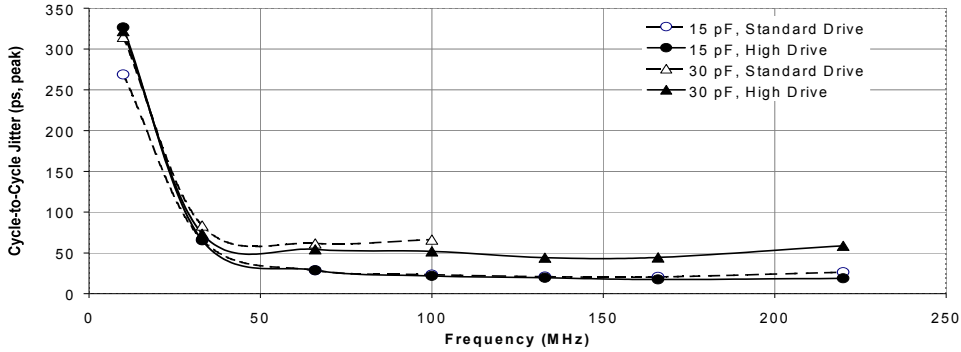

Figure 13. Typical 2.5 V Measured Cycle-to-cycle Jitter at 29 °C, versus Frequency, Drive Strength, and Loading

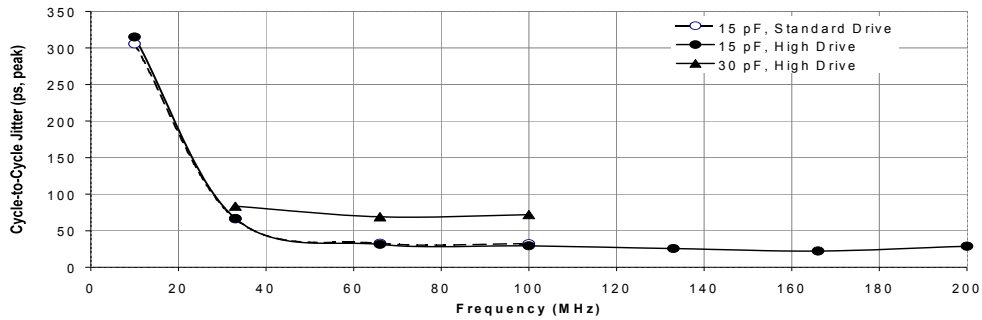

Figure 14. Typical 3.3 V Measured Period Jitter at 29 °C, versus Frequency, Drive Strength, and Loading

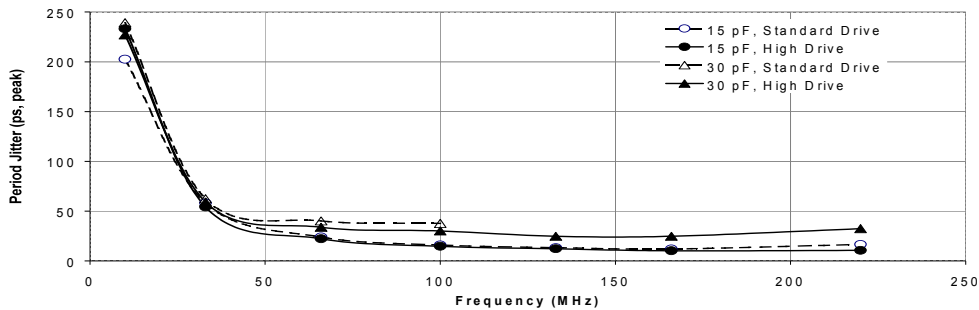
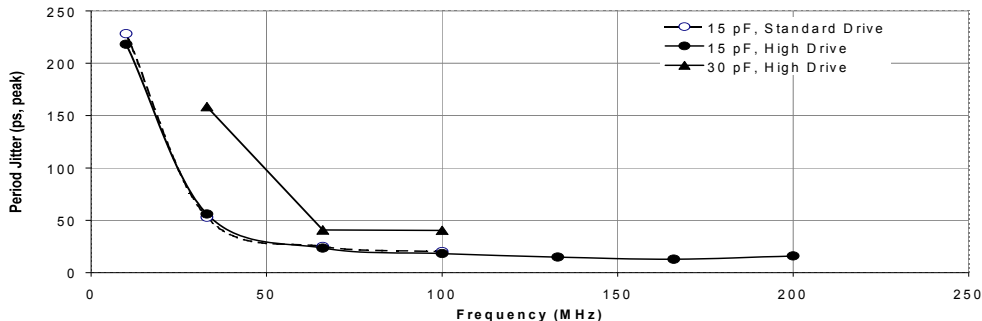
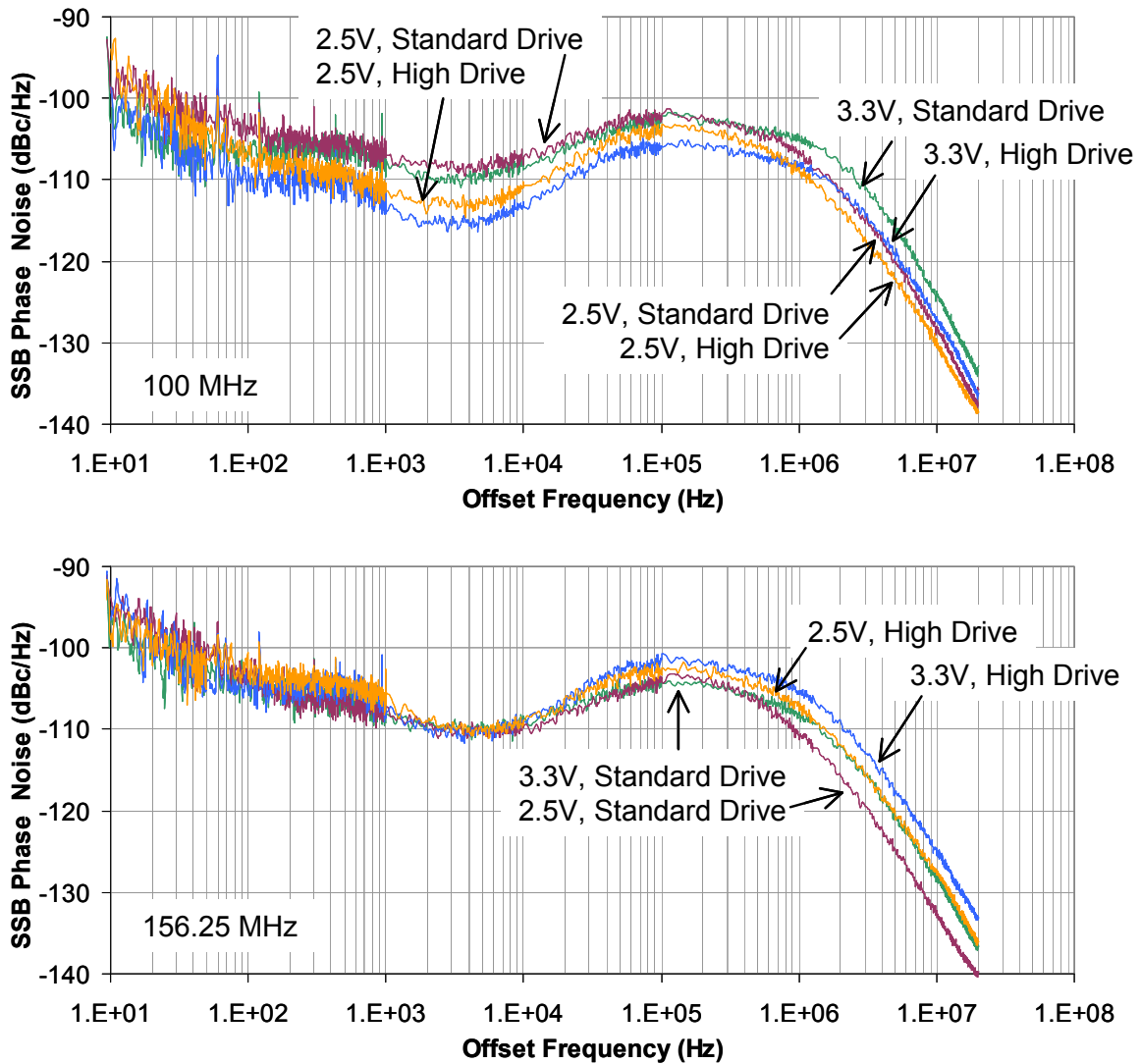

Figure 15. Typical 2.5 V Measured Period Jitter at 29 °C, versus Frequency, Drive Strength, and Loading



Supplemental Parametric Information (continued)

Figure 16. Typical Phase-noise Data at 100 MHz (top) and 156.25 MHz (bottom) across  $V_{DD}$  and Drive Strength [12]



Note

12. Typical jitter is measured at 3.3 V or 2.5 V, 29 °C, with all outputs driven into the maximum specified load. Further information regarding jitter specifications may be found in the application note "Understanding Data Sheet Jitter Specifications for Cypress Clock Products."

## Ordering Information

Ordering Code	Package Type	Operating Range
<b>Pb-free</b>		
CY23EP09SXC-1	16-pin SOIC	Commercial
CY23EP09SXC-1T	16-pin SOIC – Tape and Reel	Commercial
CY23EP09SXI-1	16-pin SOIC	Industrial
CY23EP09SXI-1T	16-pin SOIC – Tape and Reel	Industrial
CY23EP09SXC-1H	16-pin SOIC	Commercial
CY23EP09SXC-1HT	16-pin SOIC – Tape and Reel	Commercial
CY23EP09SXI-1H	16-pin SOIC	Industrial
CY23EP09SXI-1HT	16-pin SOIC – Tape and Reel	Industrial
CY23EP09ZXC-1H	16-pin TSSOP	Commercial
CY23EP09ZXC-1HT	16-pin TSSOP – Tape and Reel	Commercial
CY23EP09ZXI-1H	16-pin TSSOP	Industrial
CY23EP09ZXI-1HT	16-pin TSSOP – Tape and Reel	Industrial

## Ordering Code Definitions

CY 23EP09 S(X) C 1 (H)(T)

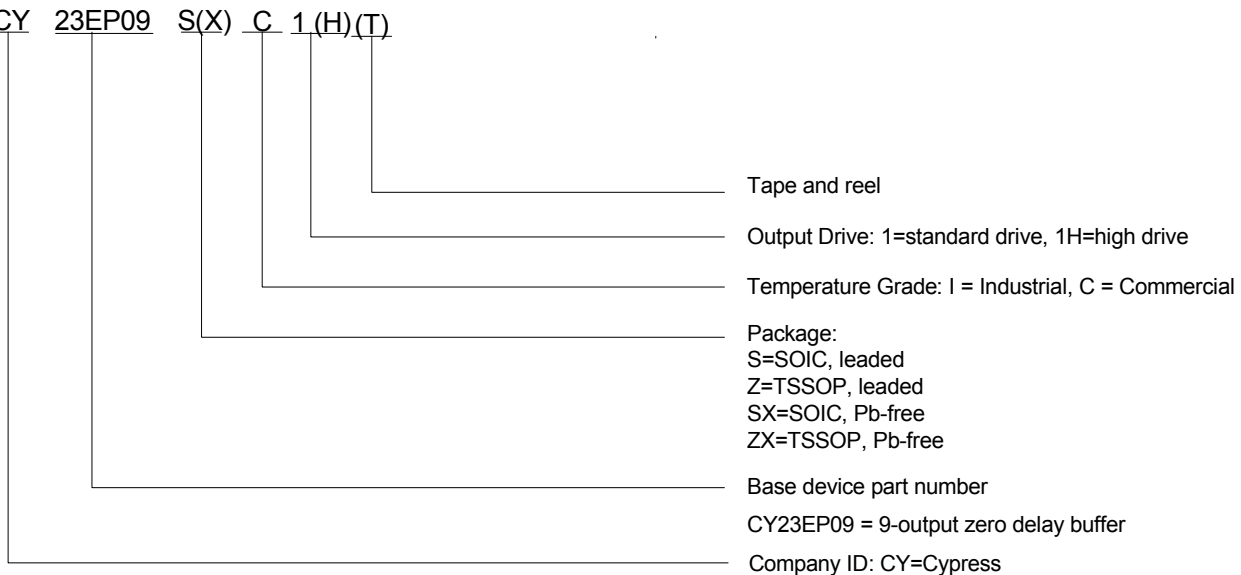

Package Diagrams

Figure 17. 16-pin SOIC (150 Mils) S16.15/SZ16.15 Package Outline, 51-85068

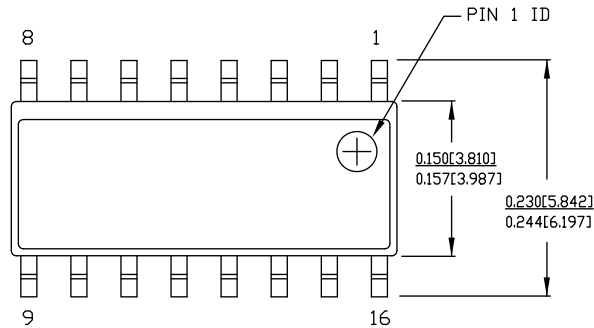

NOTE:

1. DIMENSIONS IN INCHES[MM] MAX.
2. REFERENCE JEDEC MS-012
3. PACKAGE WEIGHT : refer to PMDD spec. 001-04308

PART #	
S16.15	STANDARD PKG.
SZ16.15	LEAD FREE PKG.

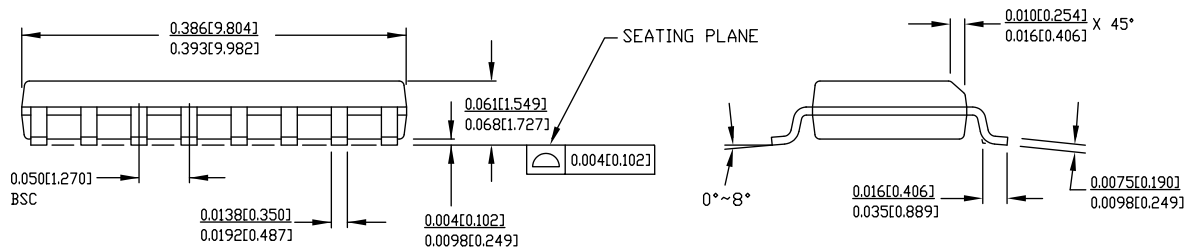

51-85068 \*E

Figure 18. 16-pin TSSOP (4.40 mm Body) Z16.173/ZZ16.173 Package Outline, 51-85091

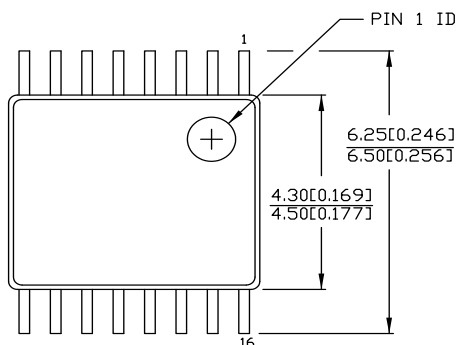

DIMENSIONS IN MM[INCHES] MIN.  
MAX.

REFERENCE JEDEC MO-153  
PACKAGE WEIGHT 0.05gms

PART #	
Z16.173	STANDARD PKG.
ZZ16.173	LEAD FREE PKG.

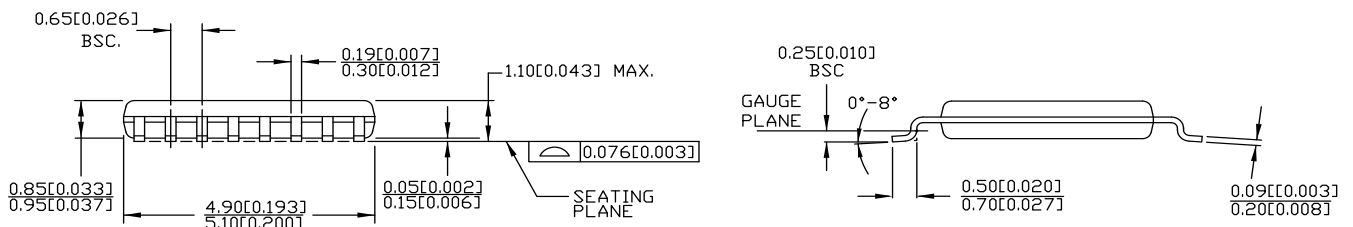

51-85091 \*E

## Acronyms

Acronym	Description
PCI	Personal Computer Interconnect
PLL	Phase Locked Loop
SDRAM	Synchronous Dynamic Random Access Memory
SOIC	Small Outline Integrated Circuit
TSSOP	Thin-Shrink Small Outline Package
ZDB	Zero Delay Buffer

## Document Conventions

### Units of Measure

Symbol	Units of Measure
°C	degree Celsius
MHz	megahertz
μA	microampere
mA	milliampere
ms	millisecond
ns	nanosecond
pF	picofarad
ps	picosecond
V	volt

**Document History Page**

Document Title: CY23EP09, 2.5 V or 3.3 V, 10–220 MHz, Low Jitter, 9-Output Zero Delay Buffer				
Document Number: 38-07760				
Rev.	ECN No.	Issue Date	Orig. of Change	Description of Change
**	345446	See ECN	RGL	New data sheet
*A	355777	See ECN	RGL	Updated part to part skew to agree with latest char results
*B	401036	See ECN	RGL	Removed Preliminary Added PLL-bypass jitter Added Phase-noise graph Added 2.5V Delay vs. Load graph
*C	3270178	06/01/2011	BASH	Updated package diagram 51-85068 and 51-85091. Added Acronyms and Units of Measure table Updated as per Template
*D	4400992	06/10/2014	AJU	Updated <a href="#">Operating Conditions</a> : Updated values of Theta Ja and Theta Jc parameters (corresponding to 16-pin TSSOP package). Updated <a href="#">Package Diagrams</a> : spec 51-85068 – Changed revision from *C to *E. spec 51-85091 – Changed revision from *C to *D. Updated in new template. Completing Sunset Review.
*E	4580603	11/26/2014	AJU	Added related documentation hyperlink in page 1. Updated package diagram

## Sales, Solutions, and Legal Information

### Worldwide Sales and Design Support

Cypress maintains a worldwide network of offices, solution centers, manufacturer's representatives, and distributors. To find the office closest to you, visit us at [Cypress Locations](#).

#### Products

<a href="#">Automotive</a>	<a href="#">cypress.com/go/automotive</a>
<a href="#">Clocks &amp; Buffers</a>	<a href="#">cypress.com/go/clocks</a>
<a href="#">Interface</a>	<a href="#">cypress.com/go/interface</a>
<a href="#">Lighting &amp; Power Control</a>	<a href="#">cypress.com/go/powerpsoc</a> <a href="#">cypress.com/go/plc</a>
<a href="#">Memory</a>	<a href="#">cypress.com/go/memory</a>
<a href="#">PSoC</a>	<a href="#">cypress.com/go/psoc</a>
<a href="#">Touch Sensing</a>	<a href="#">cypress.com/go/touch</a>
<a href="#">USB Controllers</a>	<a href="#">cypress.com/go/USB</a>
<a href="#">Wireless/RF</a>	<a href="#">cypress.com/go/wireless</a>

#### PSoC<sup>®</sup> Solutions

[psoc.cypress.com/solutions](#)  
[PSoC 1](#) | [PSoC 3](#) | [PSoC 4](#) | [PSoC 5LP](#)

#### Cypress Developer Community

[Community](#) | [Forums](#) | [Blogs](#) | [Video](#) | [Training](#)

#### Technical Support

[cypress.com/go/support](#)

---

© Cypress Semiconductor Corporation, 2010-2014. The information contained herein is subject to change without notice. Cypress Semiconductor Corporation assumes no responsibility for the use of any circuitry other than circuitry embodied in a Cypress product. Nor does it convey or imply any license under patent or other rights. Cypress products are not warranted nor intended to be used for medical, life support, life saving, critical control or safety applications, unless pursuant to an express written agreement with Cypress. Furthermore, Cypress does not authorize its products for use as critical components in life-support systems where a malfunction or failure may reasonably be expected to result in significant injury to the user. The inclusion of Cypress products in life-support systems application implies that the manufacturer assumes all risk of such use and in doing so indemnifies Cypress against all charges.

Any Source Code (software and/or firmware) is owned by Cypress Semiconductor Corporation (Cypress) and is protected by and subject to worldwide patent protection (United States and foreign), United States copyright laws and international treaty provisions. Cypress hereby grants to licensee a personal, non-exclusive, non-transferable license to copy, use, modify, create derivative works of, and compile the Cypress Source Code and derivative works for the sole purpose of creating custom software and or firmware in support of licensee product to be used only in conjunction with a Cypress integrated circuit as specified in the applicable agreement. Any reproduction, modification, translation, compilation, or representation of this Source Code except as specified above is prohibited without the express written permission of Cypress.

Disclaimer: CYPRESS MAKES NO WARRANTY OF ANY KIND, EXPRESS OR IMPLIED, WITH REGARD TO THIS MATERIAL, INCLUDING, BUT NOT LIMITED TO, THE IMPLIED WARRANTIES OF MERCHANTABILITY AND FITNESS FOR A PARTICULAR PURPOSE. Cypress reserves the right to make changes without further notice to the materials described herein. Cypress does not assume any liability arising out of the application or use of any product or circuit described herein. Cypress does not authorize its products for use as critical components in life-support systems where a malfunction or failure may reasonably be expected to result in significant injury to the user. The inclusion of Cypress' product in a life-support systems application implies that the manufacturer assumes all risk of such use and in doing so indemnifies Cypress against all charges.

Use may be limited by and subject to the applicable Cypress software license agreement.

# AMEYA360

## Components Supply Platform

Authorized Distribution Brand :



Website :

Welcome to visit [www.ameya360.com](http://www.ameya360.com)

Contact Us :

➤ Address :

401 Building No.5, JiuGe Business Center, Lane 2301, Yishan Rd  
Minhang District, Shanghai , China

➤ Sales :

Direct +86 (21) 6401-6692

Email [amall@ameya360.com](mailto:amall@ameya360.com)

QQ 800077892

Skype [ameyasales1](#) [ameyasales2](#)

➤ Customer Service :

Email [service@ameya360.com](mailto:service@ameya360.com)

➤ Partnership :

Tel +86 (21) 64016692-8333

Email [mkt@ameya360.com](mailto:mkt@ameya360.com)