



# FDD3510H

**Dual N & P-Channel PowerTrench<sup>®</sup> MOSFET**  
**N-Channel: 80V, 13.9A, 80mΩ P-Channel: -80V, -9.4A, 190mΩ**

## Features

Q1: N-Channel

- Max  $r_{DS(on)}$  = 80mΩ at  $V_{GS} = 10V, I_D = 4.3A$
- Max  $r_{DS(on)}$  = 88mΩ at  $V_{GS} = 6V, I_D = 4.1A$

Q2: P-Channel

- Max  $r_{DS(on)}$  = 190mΩ at  $V_{GS} = -10V, I_D = -2.8A$
- Max  $r_{DS(on)}$  = 224mΩ at  $V_{GS} = -4.5V, I_D = -2.6A$
- 100% UIL Tested
- RoHS Compliant

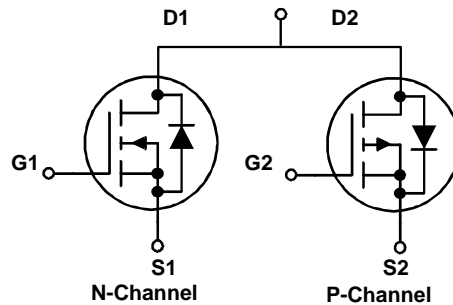
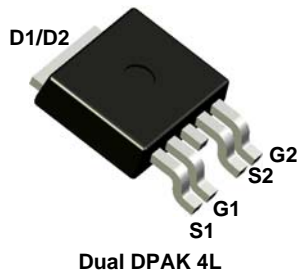


## General Description

These dual N and P-Channel enhancement mode Power MOSFETs are produced using Fairchild Semiconductor's advanced PowerTrench<sup>®</sup> process that has been especially tailored to minimize on-state resistance and yet maintain superior switching performance.

## Applications

- Inverter
- H-Bridge



## MOSFET Maximum Ratings $T_C = 25^\circ\text{C}$ unless otherwise noted

Symbol	Parameter	Q1	Q2	Units
$V_{DS}$	Drain to Source Voltage	80	-80	V
$V_{GS}$	Gate to Source Voltage	$\pm 20$	$\pm 20$	V
$I_D$	Drain Current - Continuous $T_C = 25^\circ\text{C}$	13.9	-9.4	A
	- Continuous $T_A = 25^\circ\text{C}$	4.3	-2.8	
	- Pulsed	20	-10	
$P_D$	Power Dissipation for Single Operation $T_C = 25^\circ\text{C}$ (Note 1)	35	32	W
	$T_A = 25^\circ\text{C}$ (Note 1a)	3.1		
	$T_A = 25^\circ\text{C}$ (Note 1b)	1.3		
$E_{AS}$	Single Pulse Avalanche Energy (Note 3)	37	54	mJ
$T_J, T_{STG}$	Operating and Storage Junction Temperature Range	-55 to +150		$^\circ\text{C}$

## Thermal Characteristics

$R_{\theta JC}$	Thermal Resistance, Junction to Case, Single Operation for Q1 (Note 1)	3.5	$^\circ\text{C/W}$
$R_{\theta JC}$	Thermal Resistance, Junction to Case, Single Operation for Q2 (Note 1)	3.9	

## Package Marking and Ordering Information

Device Marking	Device	Package	Reel Size	Tape Width	Quantity
FDD3510H	FDD3510H	TO-252-4L	13"	16mm	2500 units

FDD3510H Dual N & P-Channel PowerTrench<sup>®</sup> MOSFET

### Electrical Characteristics $T_J = 25^\circ\text{C}$ unless otherwise noted

Symbol	Parameter	Test Conditions	Type	Min	Typ	Max	Units
--------	-----------	-----------------	------	-----	-----	-----	-------

#### Off Characteristics

$BV_{DSS}$	Drain to Source Breakdown Voltage	$I_D = 250\mu\text{A}, V_{GS} = 0\text{V}$ $I_D = -250\mu\text{A}, V_{GS} = 0\text{V}$	Q1 Q2	80 -80			V
$\frac{\Delta BV_{DSS}}{\Delta T_J}$	Breakdown Voltage Temperature Coefficient	$I_D = 250\mu\text{A}$ , referenced to $25^\circ\text{C}$ $I_D = -250\mu\text{A}$ , referenced to $25^\circ\text{C}$	Q1 Q2		84 -67	mV	$^\circ\text{C}$
$I_{DSS}$	Zero Gate Voltage Drain Current	$V_{DS} = 64\text{V}, V_{GS} = 0\text{V}$ $V_{DS} = -64\text{V}, V_{GS} = 0\text{V}$	Q1 Q2			1 -1	$\mu\text{A}$
$I_{GSS}$	Gate to Source Leakage Current	$V_{GS} = \pm 20\text{V}, V_{DS} = 0\text{V}$	Q1 Q2			$\pm 100$ $\pm 100$	nA nA

#### On Characteristics

$V_{GS(th)}$	Gate to Source Threshold Voltage	$V_{GS} = V_{DS}, I_D = 250\mu\text{A}$ $V_{GS} = V_{DS}, I_D = -250\mu\text{A}$	Q1 Q2	2.0 -1.0	2.6 -1.6	4.0 -3.0	V
$\frac{\Delta V_{GS(th)}}{\Delta T_J}$	Gate to Source Threshold Voltage Temperature Coefficient	$I_D = 250\mu\text{A}$ , referenced to $25^\circ\text{C}$ $I_D = -250\mu\text{A}$ , referenced to $25^\circ\text{C}$	Q1 Q2		-6.7 4.6	mV	$^\circ\text{C}$
$r_{DS(on)}$	Static Drain to Source On Resistance	$V_{GS} = 10\text{V}, I_D = 4.3\text{A}$ $V_{GS} = 6.0\text{V}, I_D = 4.1\text{A}$ $V_{GS} = 10\text{V}, I_D = 4.3\text{A}, T_J = 125^\circ\text{C}$	Q1		64 70 121	80 88 152	m $\Omega$
		$V_{GS} = -10\text{V}, I_D = -2.8\text{A}$ $V_{GS} = -4.5\text{V}, I_D = -2.6\text{A}$ $V_{GS} = -10\text{V}, I_D = -2.8\text{A}, T_J = 125^\circ\text{C}$	Q2		153 184 259	190 224 322	
$g_{FS}$	Forward Transconductance	$V_{DD} = 10\text{V}, I_D = 4.3\text{A}$ $V_{DD} = -5\text{V}, I_D = -2.8\text{A}$	Q1 Q2		15 6.8		S

#### Dynamic Characteristics

$C_{iss}$	Input Capacitance	Q1 $V_{DS} = 40\text{V}, V_{GS} = 0\text{V}, f = 1\text{MHz}$	Q1 Q2		600 660	800 880	pF
$C_{oss}$	Output Capacitance	Q2	Q1 Q2		56 50	75 70	pF
$C_{rss}$	Reverse Transfer Capacitance	$V_{DS} = -40\text{V}, V_{GS} = 0\text{V}, f = 1\text{MHz}$	Q1 Q2		27 25	41 40	pF
$R_g$	Gate Resistance	$f = 1\text{MHz}$	Q1 Q2		1.7 7.2		$\Omega$

#### Switching Characteristics

$t_{d(on)}$	Turn-On Delay Time	Q1	Q1 Q2		7 6	13 11	ns
$t_r$	Rise Time	$V_{DD} = 40\text{V}, I_D = 4.3\text{A},$ $V_{GS} = 10\text{V}, R_{GEN} = 6\Omega$	Q1		2	10	ns
			Q2		3	10	
$t_{d(off)}$	Turn-Off Delay Time	Q2 $V_{DD} = -40\text{V}, I_D = -2.8\text{A},$ $V_{GS} = -10\text{V}, R_{GEN} = 6\Omega$	Q1		16	29	ns
			Q2		25	40	
$t_f$	Fall Time	$V_{GS} = -10\text{V}, R_{GEN} = 6\Omega$	Q1		2	10	ns
			Q2		5	10	
$Q_{g(TOT)}$	Total Gate Charge	Q1 $V_{GS} = 10\text{V}, V_{DD} = 40\text{V}, I_D = 4.3\text{A}$	Q1		13	18	nC
			Q2		14	20	
$Q_{gs}$	Gate to Source Charge	Q2	Q1		2.3		nC
			Q2		1.9		
$Q_{gd}$	Gate to Drain "Miller" Charge	$V_{GS} = -10\text{V}, V_{DD} = -40\text{V}, I_D = -2.8\text{A}$	Q1		3.2		nC
			Q2		2.9		

## Electrical Characteristics $T_J = 25^\circ\text{C}$ unless otherwise noted

Symbol	Parameter	Test Conditions	Type	Min	Typ	Max	Units
--------	-----------	-----------------	------	-----	-----	-----	-------

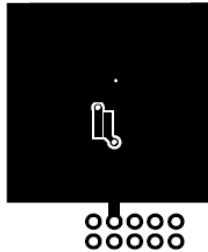
### Drain-Source Diode Characteristics

$V_{SD}$	Source to Drain Diode Forward Voltage	$V_{GS} = 0V, I_S = 2.6A$ (Note 2) $V_{GS} = 0V, I_S = -2.6A$ (Note 2)	Q1 Q2	0.8 -0.8	1.2 -1.2		V
$t_{rr}$	Reverse Recovery Time	$I_F = 4.3A, di/dt = 100A/s$	Q1 Q2	29 30	46 48		ns
$Q_{rr}$	Reverse Recovery Charge	$I_F = -2.8A, di/dt = 100A/s$	Q1 Q2	28 30	45 48		nC

#### Notes:

- $R_{\theta JA}$  is determined with the device mounted on a  $1\text{in}^2$  pad 2 oz copper pad on a  $1.5 \times 1.5$  in. board of FR-4 material.  $R_{\theta JC}$  is guaranteed by design while  $R_{\theta CA}$  is determined by the user's board design.

Q1



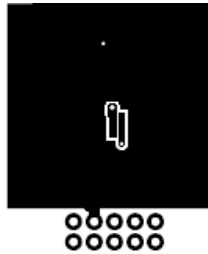
a.  $40^\circ\text{C/W}$  when mounted on a  $1\text{in}^2$  pad of 2 oz copper

Scale 1 : 1 on letter size paper



b.  $96^\circ\text{C/W}$  when mounted on a minimum pad of 2 oz copper

Q2



a.  $40^\circ\text{C/W}$  when mounted on a  $1\text{in}^2$  pad of 2 oz copper

Scale 1 : 1 on letter size paper



b.  $96^\circ\text{C/W}$  when mounted on a minimum pad of 2 oz copper

- Pulse Test: Pulse Width  $< 300\mu\text{s}$ , Duty cycle  $< 2.0\%$ .

- Starting  $T_J = 25^\circ\text{C}$ , N-ch:  $L = 3\text{mH}$ ,  $I_{AS} = 5A$ ,  $V_{DD} = 80V$ ,  $V_{GS} = 10V$ ; P-ch:  $L = 3\text{mH}$ ,  $I_{AS} = -6A$ ,  $V_{DD} = -80V$ ,  $V_{GS} = -10V$ .

**Typical Characteristics (Q1 N-Channel)**  $T_J = 25^\circ\text{C}$  unless otherwise noted

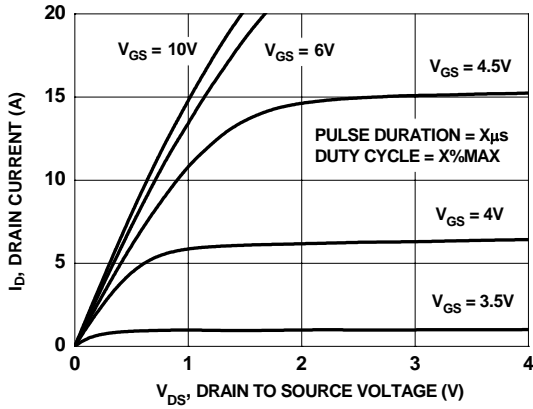


Figure 1. On Region Characteristics

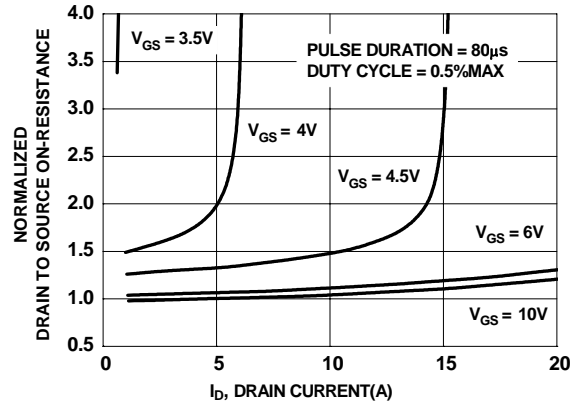


Figure 2. Normalized On-Resistance vs Drain Current and Gate Voltage

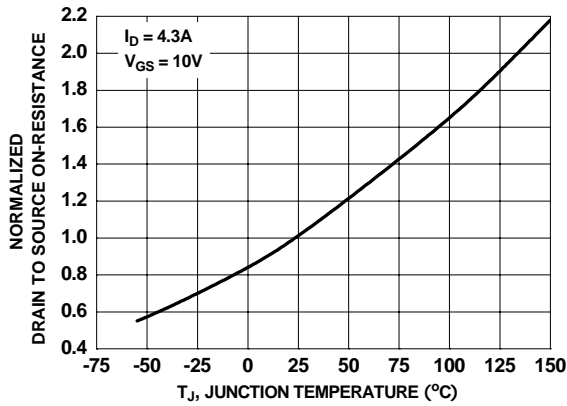


Figure 3. Normalized On Resistance vs Junction Temperature

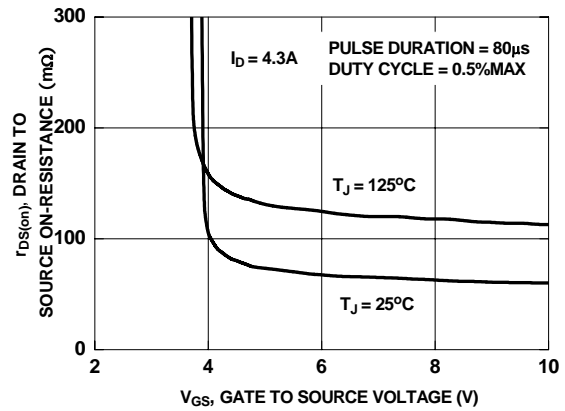


Figure 4. On-Resistance vs Gate to Source Voltage

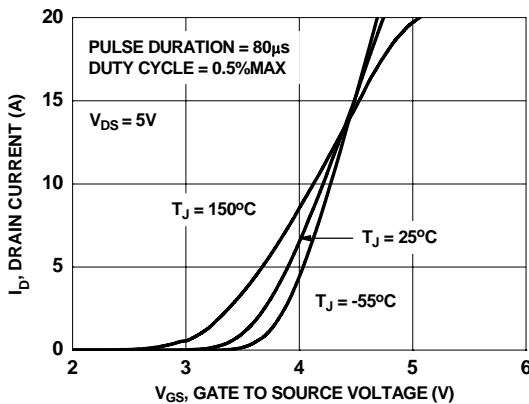


Figure 5. Transfer Characteristics

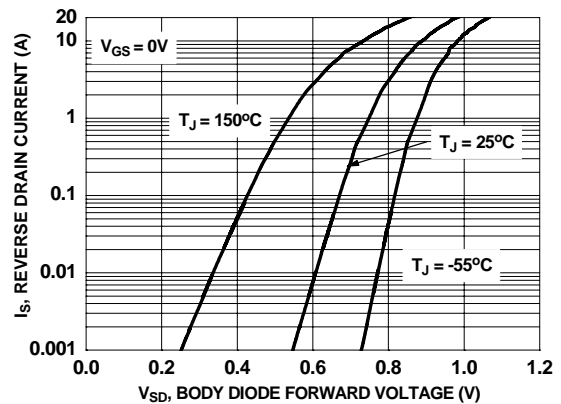
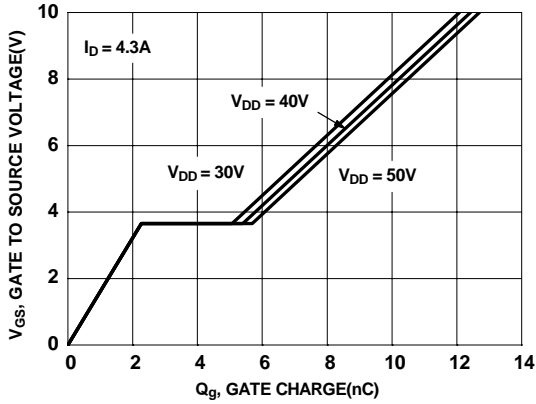
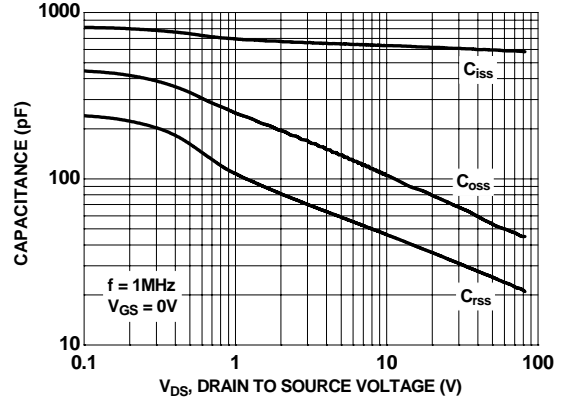


Figure 6. Source to Drain Diode Forward Voltage vs Source Current

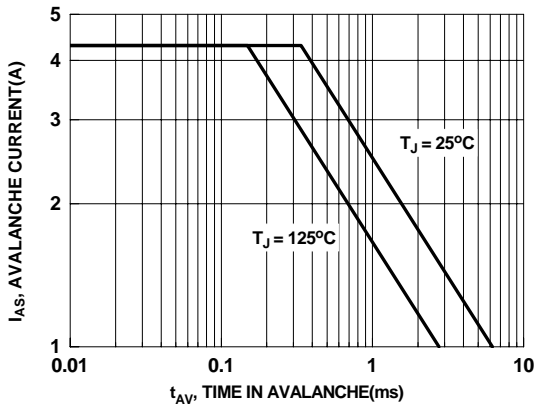
**Typical Characteristics (Q1 N-Channel)**  $T_J = 25^\circ\text{C}$  unless otherwise noted



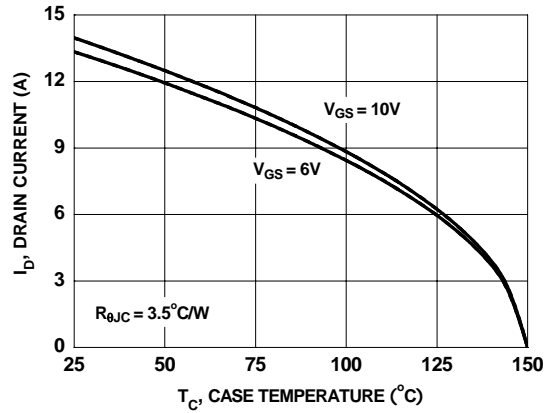
**Figure 7. Gate Charge Characteristics**



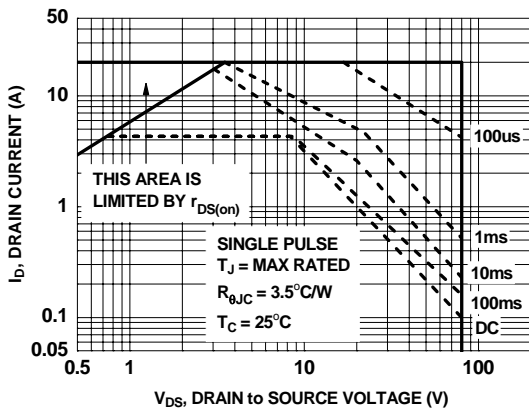
**Figure 8. Capacitance vs Drain to Source Voltage**



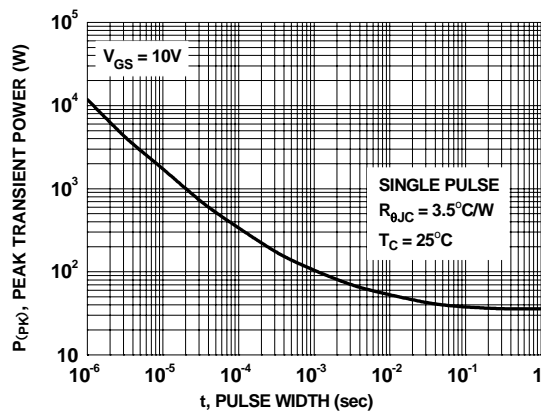
**Figure 9. Unclamped Inductive Switching Capability**



**Figure 10. Maximum Continuous Drain Current vs Case Temperature**

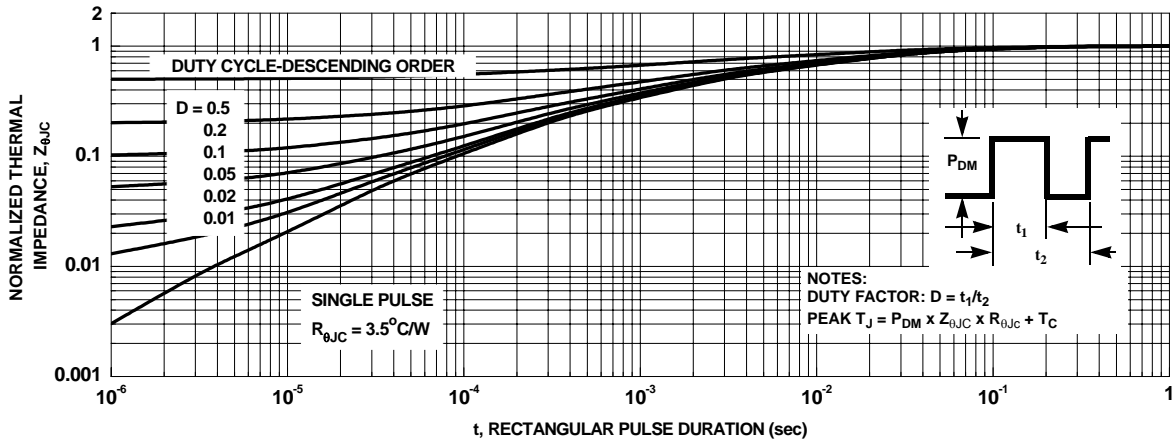


**Figure 11. Forward Bias Safe Operating Area**

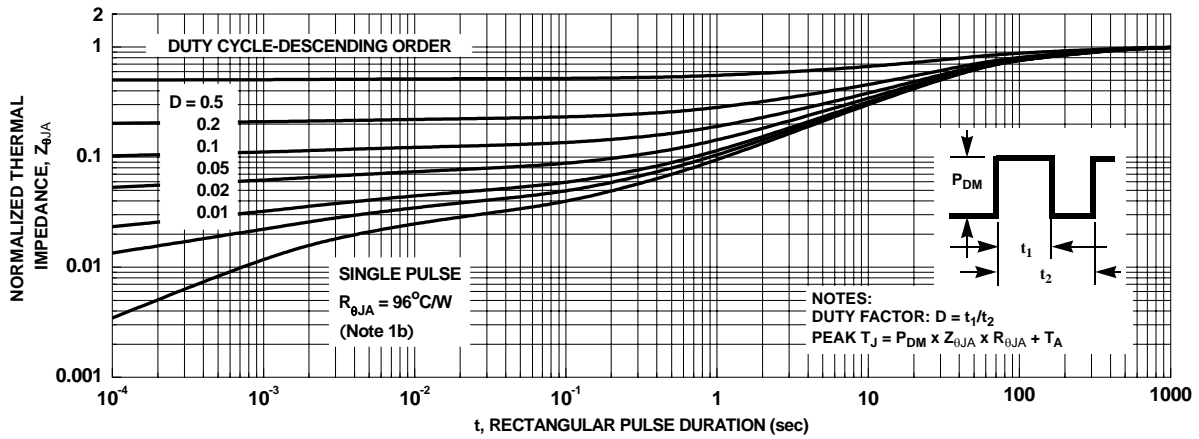


**Figure 12. Single Pulse Maximum Power Dissipation**

**Typical Characteristics (Q1 N-Channel)**  $T_J = 25^\circ\text{C}$  unless otherwise noted



**Figure 13. Transient Thermal Response Curve**



**Figure 14. Transient Thermal Response Curve**

**Typical Characteristics (Q2 P-Channel)**  $T_J = 25^\circ\text{C}$  unless otherwise noted

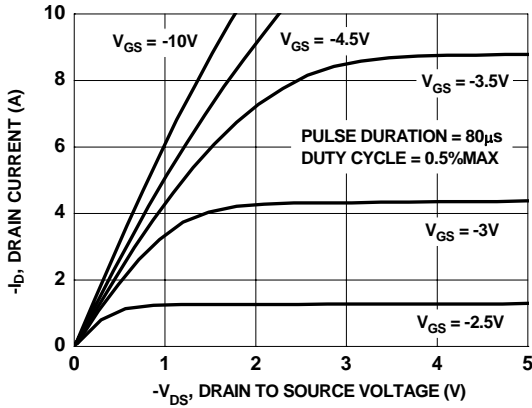


Figure 15. On-Region Characteristics

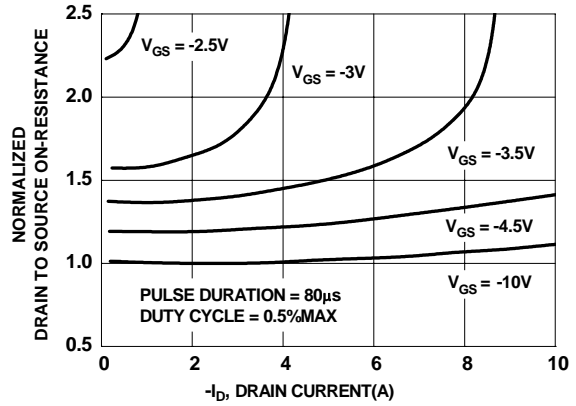


Figure 16. Normalized on-Resistance vs Drain Current and Gate Voltage

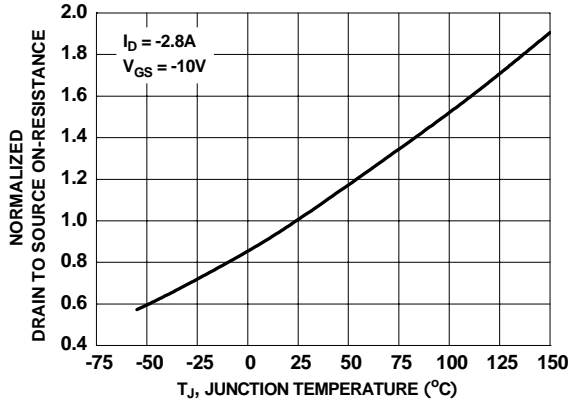


Figure 17. Normalized On-Resistance vs Junction Temperature

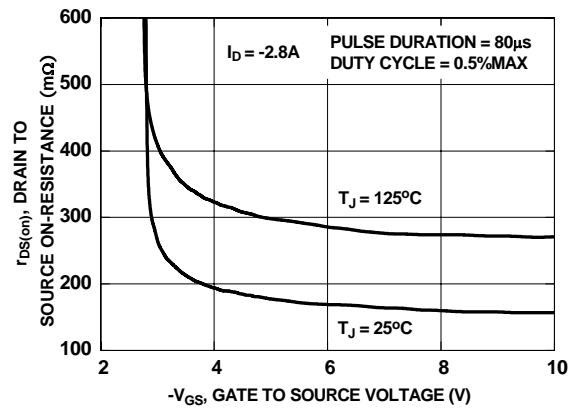


Figure 18. On-Resistance vs Gate to Source Voltage

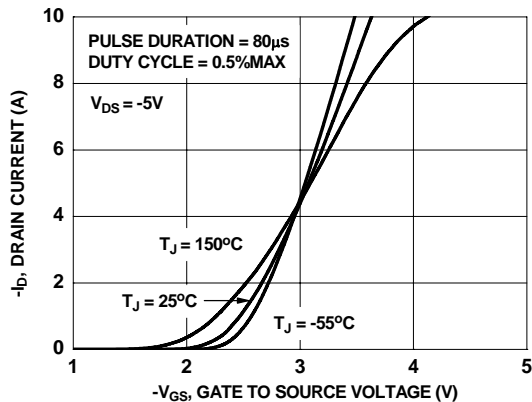


Figure 19. Transfer Characteristics

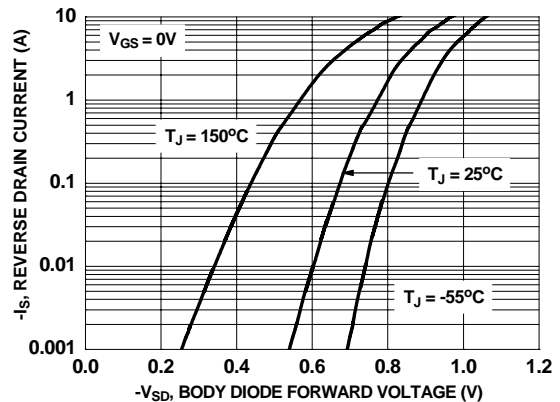
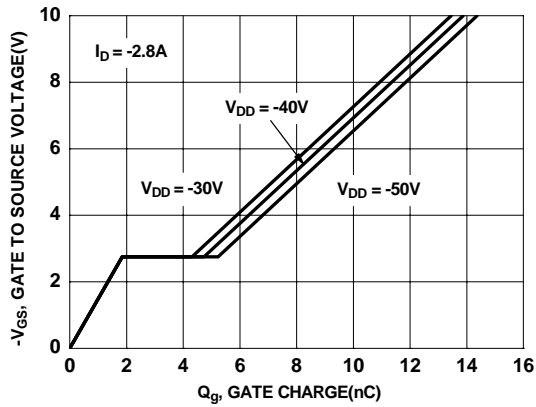
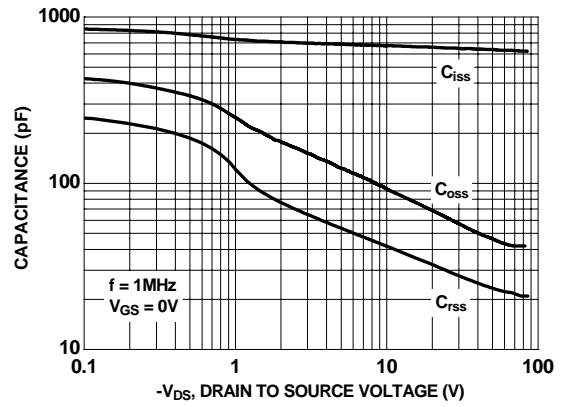


Figure 20. Source to Drain Diode Forward Voltage vs Source Current

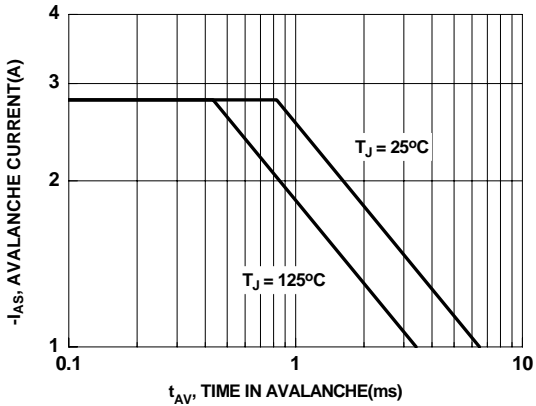
**Typical Characteristics (Q2 P-Channel)**  $T_J = 25^\circ\text{C}$  unless otherwise noted



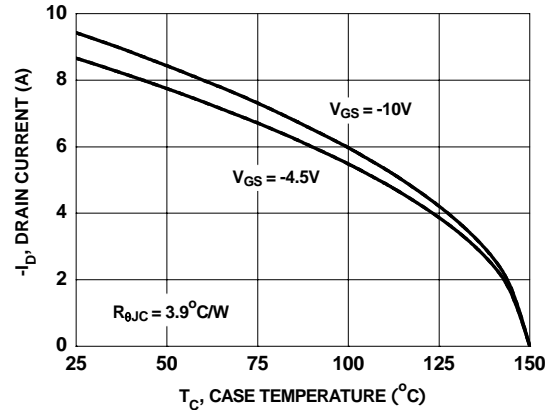
**Figure 21. Gate Charge Characteristics**



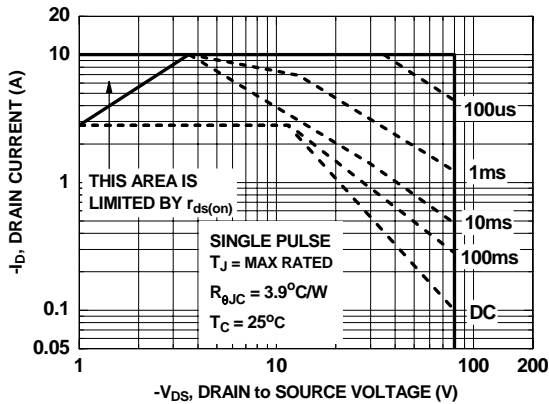
**Figure 22. Capacitance vs Drain to Source Voltage**



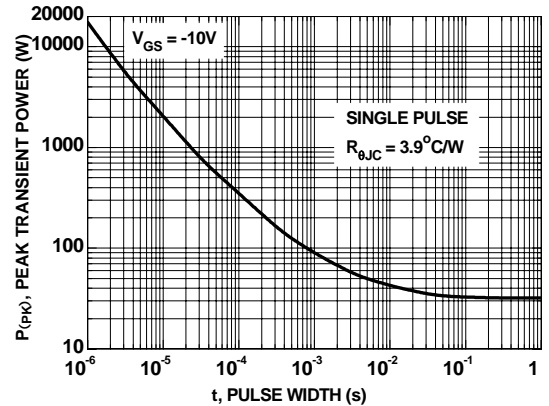
**Figure 23. Unclamped Inductive Switching Capability**



**Figure 24. Maximum Continuous Drain Current vs Case Temperature**

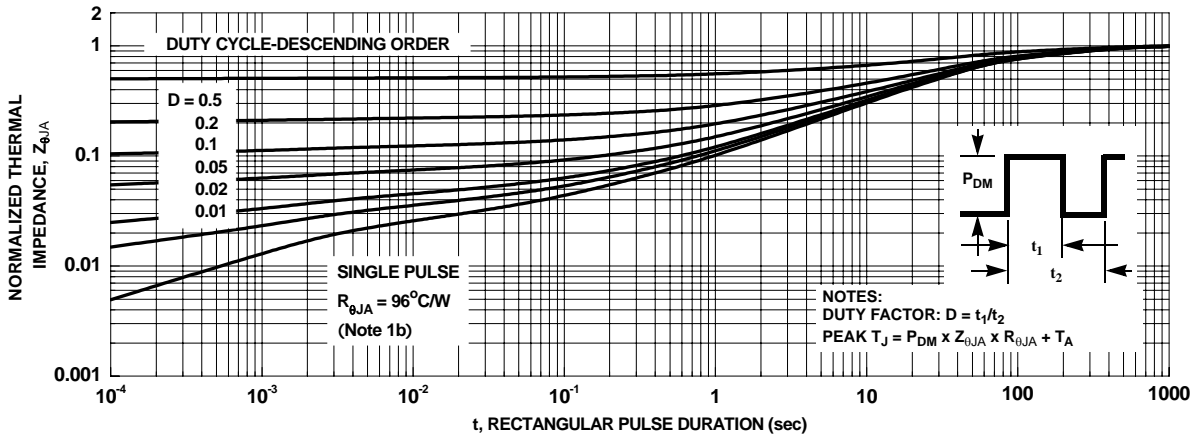
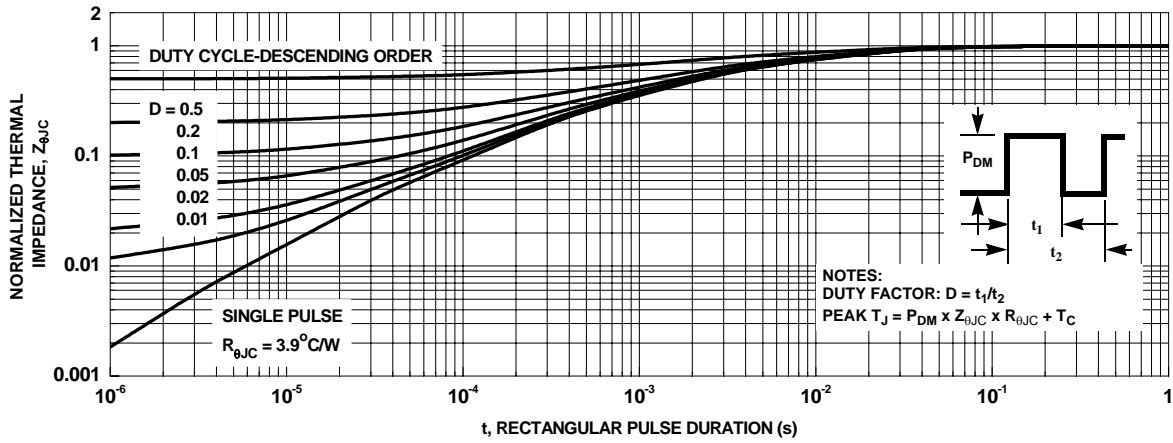


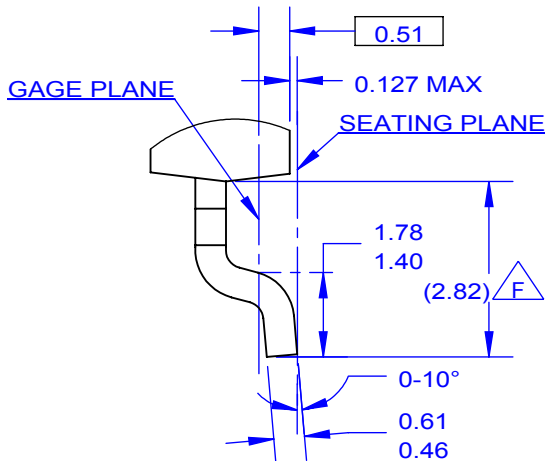
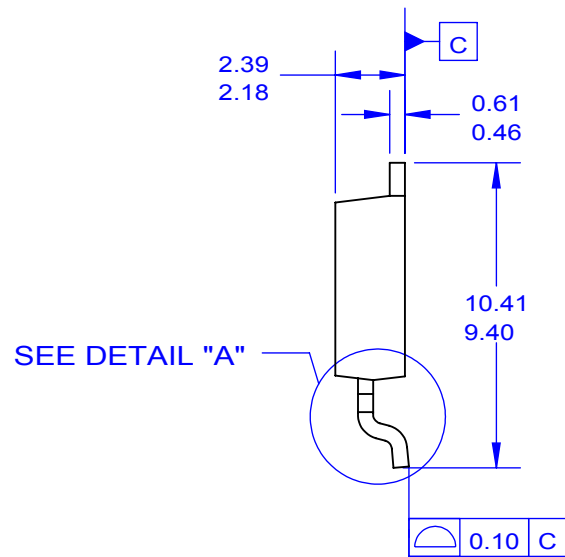
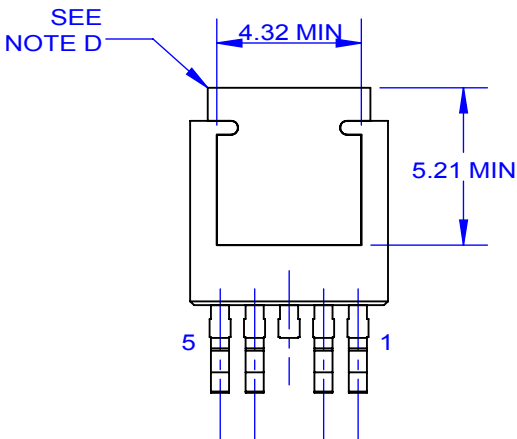
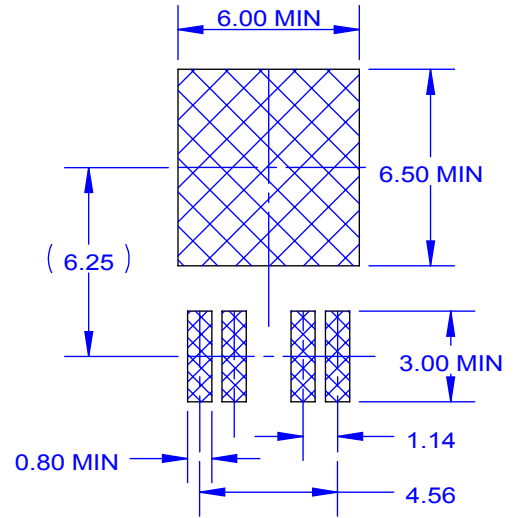
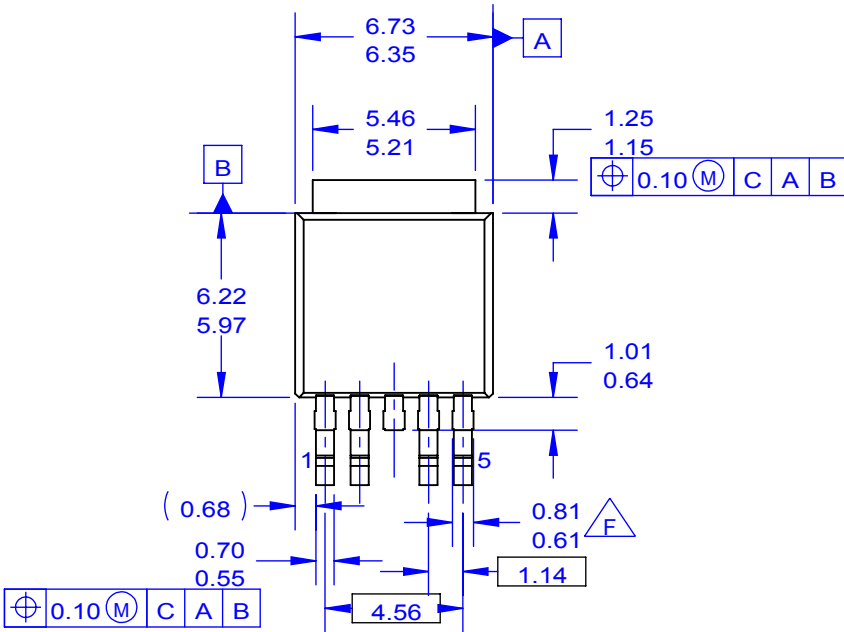
**Figure 25. Forward Bias Safe Operating Area**



**Figure 26. Single Pulse Maximum Power Dissipation**

**Typical Characteristics (Q2 P-Channel)**  $T_J = 25^\circ\text{C}$  unless otherwise noted





DETAIL A  
SCALE 2:1

NOTES: UNLESS OTHERWISE SPECIFIED

- A. THIS PACKAGE CONFORMS TO JEDEC, TO252 VARIATION AD.
- B. ALL DIMENSIONS ARE IN MILLIMETERS.
- C. DIMENSIONS ARE EXCLUSIVE OF BURRS, MOLD FLASH AND TIE BAR PROTRUSIONS
- D. HEATSINK TOP EDGE COULD BE IN CHAMFERED CORNERS OR EDGE PROTRUSION.
- E. DIMENSIONS AND TOLERANCES AS PER ASME Y14.5-2009.
- F. EXCEPTION TO TO-252 STANDARD.
- G. FILE NAME: TO252B05REV3
- H. FAIRCHILDSEMICONDUCTOR



**TRADEMARKS**

The following includes registered and unregistered trademarks and service marks, owned by Fairchild Semiconductor and/or its global subsidiaries, and is not intended to be an exhaustive list of all such trademarks.

AccuPower™  
AttitudeEngine™  
Awinda®  
AX-CAP®\*  
BitSiC™  
Build it Now™  
CorePLUS™  
CorePOWER™  
CROSSVOL™  
CTL™  
Current Transfer Logic™  
DEUXPEED®  
Dual Cool™  
EcoSPARK®  
EfficientMax™  
ESBC™  
F®  
Fairchild®  
Fairchild Semiconductor®  
FACT Quiet Series™  
FACT®  
FAST®  
FastvCore™  
FETBench™  
FPS™

F-PFS™  
FRFET®  
Global Power Resource™  
GreenBridge™  
Green FPS™  
Green FPS™ e-Series™  
Gmax™  
GTO™  
IntelliMAX™  
ISOPLANAR™  
Making Small Speakers Sound Louder and Better™  
MegaBuck™  
MICROCOUPLER™  
MicroFET™  
MicroPak™  
MicroPak2™  
MillerDrive™  
MotionMax™  
MotionGrid®  
MTI®  
MTX®  
MVN®  
mWSaver®  
OptoHiT™  
OPTOLOGIC®

OPTOPLANAR®  
Power Supply WebDesigner™  
PowerTrench®  
PowerXS™  
Programmable Active Droop™  
QFET®  
QS™  
Quiet Series™  
RapidConfigure™  
Saving our world, 1mW/W/kW at a time™  
SignalWise™  
SmartMax™  
SMART START™  
Solutions for Your Success™  
SPM®  
STEALTH™  
SuperFET®  
SuperSOT™-3  
SuperSOT™-6  
SuperSOT™-8  
SupreMOS®  
SyncFET™  
Sync-Lock™

SYSTEM GENERAL®  
TinyBoost®  
TinyBuck®  
TinyCalc™  
TinyLogic®  
TINYOPTO™  
TinyPower™  
TinyPWM™  
TinyWire™  
TranSiC™  
TriFault Detect™  
TRUECURRENT®\*  
µSerDes™  
SerDes®  
UHC®  
Ultra FRFET™  
UniFET™  
VCX™  
VisualMax™  
VoltagePlus™  
XS™  
Xsens™  
仙童™

\* Trademarks of System General Corporation, used under license by Fairchild Semiconductor.

**DISCLAIMER**

FAIRCHILD SEMICONDUCTOR RESERVES THE RIGHT TO MAKE CHANGES WITHOUT FURTHER NOTICE TO ANY PRODUCTS HEREIN TO IMPROVE RELIABILITY, FUNCTION, OR DESIGN. TO OBTAIN THE LATEST, MOST UP-TO-DATE DATASHEET AND PRODUCT INFORMATION, VISIT OUR WEBSITE AT [HTTP://WWW.FAIRCHILDSEMI.COM](http://www.fairchildsemi.com). FAIRCHILD DOES NOT ASSUME ANY LIABILITY ARISING OUT OF THE APPLICATION OR USE OF ANY PRODUCT OR CIRCUIT DESCRIBED HEREIN; NEITHER DOES IT CONVEY ANY LICENSE UNDER ITS PATENT RIGHTS, NOR THE RIGHTS OF OTHERS. THESE SPECIFICATIONS DO NOT EXPAND THE TERMS OF FAIRCHILD'S WORLDWIDE TERMS AND CONDITIONS, SPECIFICALLY THE WARRANTY THEREIN, WHICH COVERS THESE PRODUCTS.

**LIFE SUPPORT POLICY**

FAIRCHILD'S PRODUCTS ARE NOT AUTHORIZED FOR USE AS CRITICAL COMPONENTS IN LIFE SUPPORT DEVICES OR SYSTEMS WITHOUT THE EXPRESS WRITTEN APPROVAL OF FAIRCHILD SEMICONDUCTOR CORPORATION.

As used herein:

- 1. Life support devices or systems are devices or systems which, (a) are intended for surgical implant into the body or (b) support or sustain life, and (c) whose failure to perform when properly used in accordance with instructions for use provided in the labeling, can be reasonably expected to result in a significant injury of the user.
- 2. A critical component in any component of a life support, device, or system whose failure to perform can be reasonably expected to cause the failure of the life support device or system, or to affect its safety or effectiveness.

**ANTI-COUNTERFEITING POLICY**

Fairchild Semiconductor Corporation's Anti-Counterfeiting Policy. Fairchild's Anti-Counterfeiting Policy is also stated on our external website, [www.fairchildsemi.com](http://www.fairchildsemi.com), under Sales Support.

Counterfeiting of semiconductor parts is a growing problem in the industry. All manufacturers of semiconductor products are experiencing counterfeiting of their parts. Customers who inadvertently purchase counterfeit parts experience many problems such as loss of brand reputation, substandard performance, failed applications, and increased cost of production and manufacturing delays. Fairchild is taking strong measures to protect ourselves and our customers from the proliferation of counterfeit parts. Fairchild strongly encourages customers to purchase Fairchild parts either directly from Fairchild or from Authorized Fairchild Distributors who are listed by country on our web page cited above. Products customers buy either from Fairchild directly or from Authorized Fairchild Distributors are genuine parts, have full traceability, meet Fairchild's quality standards for handling and storage and provide access to Fairchild's full range of up-to-date technical and product information. Fairchild and our Authorized Distributors will stand behind all warranties and will appropriately address any warranty issues that may arise. Fairchild will not provide any warranty coverage or other assistance for parts bought from Unauthorized Sources. Fairchild is committed to combat this global problem and encourage our customers to do their part in stopping this practice by buying direct or from authorized distributors.

**PRODUCT STATUS DEFINITIONS**

**Definition of Terms**

Datasheet Identification	Product Status	Definition
Advance Information	Formative / In Design	Datasheet contains the design specifications for product development. Specifications may change in any manner without notice.
Preliminary	First Production	Datasheet contains preliminary data; supplementary data will be published at a later date. Fairchild Semiconductor reserves the right to make changes at any time without notice to improve design.
No Identification Needed	Full Production	Datasheet contains final specifications. Fairchild Semiconductor reserves the right to make changes at any time without notice to improve the design.
Obsolete	Not In Production	Datasheet contains specifications on a product that is discontinued by Fairchild Semiconductor. The datasheet is for reference information only.

# AMEYA360

## Components Supply Platform

Authorized Distribution Brand :



Website :

Welcome to visit [www.ameya360.com](http://www.ameya360.com)

Contact Us :

➤ Address :

401 Building No.5, JiuGe Business Center, Lane 2301, Yishan Rd  
Minhang District, Shanghai , China

➤ Sales :

Direct +86 (21) 6401-6692

Email [amall@ameya360.com](mailto:amall@ameya360.com)

QQ 800077892

Skype [ameyasales1](#) [ameyasales2](#)

➤ Customer Service :

Email [service@ameya360.com](mailto:service@ameya360.com)

➤ Partnership :

Tel +86 (21) 64016692-8333

Email [mkt@ameya360.com](mailto:mkt@ameya360.com)