

Analog Devices Welcomes Hittite Microwave Corporation

NO CONTENT ON THE ATTACHED DOCUMENT HAS CHANGED



THIS PAGE INTENTIONALLY LEFT BLANK



Typical Applications

The HMC935LP5E is ideal for:

- EW Receivers
- Military Radar
- Test Equipment
- Satellite Communications
- Beam Forming Modules

Features

- Wide Bandwidth: 2 - 20 GHz
- 180° Phase Shift
- Low Insertion Loss: 4 dB
- Low Phase Error: +20/-8 deg Typ.
- Single Positive Voltage Control
- 32 Lead 5 x 5 mm QFN Package: 25 mm²

Functional Diagram

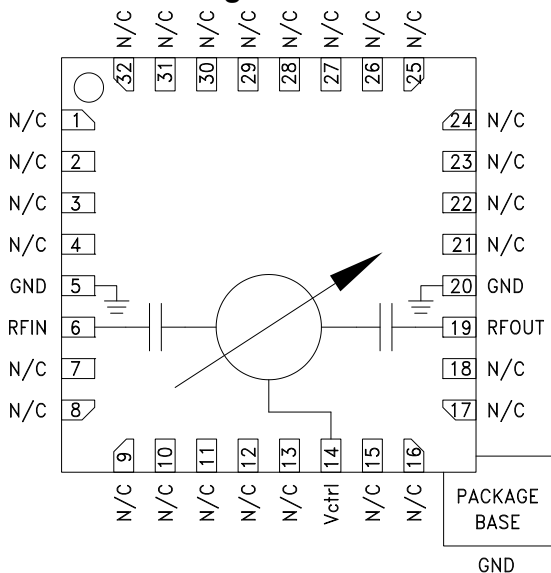

General Description

The HMC935LP5E is an Analog Phase Shifter which is controlled via an analog control voltage from 0.5 to +11V. The HMC935LP5E provides a continuously variable phase shift of 0 to 180 degrees from 2 to 20 GHz, with extremely consistent low insertion loss versus phase shift and frequency. The high accuracy HMC935LP5E is monotonic with respect to control voltage and features a typical low phase error of +20/-8 degrees. The HMC935LP5E is housed in an RoHS compliant 5 x 5 mm QFN leadless package.

Electrical Specifications, $T_A = +25\text{ }^\circ\text{C}$, 50 Ohm System

Parameter	Min.	Typ.	Max.	Units
Frequency Range	2		20	GHz
Phase Shift Range		180		deg
Insertion Loss		4		dB
Return Loss (input and output)		15		dB
Control Voltage Range	0.5		11	V
Control Current Range			±1	mA
Input IP3		30		dBm
Input Power @ -5° Shift In Insertion Phase (Vctrl = 0.5V)		15		dBm
Input Power @ -3° Shift In Insertion Phase (Vctrl = 3.0V)		20		dBm
Phase Voltage Sensitivity		20		deg/V
Phase Error (peak) [1]		+28 / -15		deg
Phase Error (average) [1]		+20 / -8		deg
Modulation Bandwidth		10		MHz
Insertion Phase Temperature Sensitivity		0.07		deg/°C

[1] Up to a phase shift of 180 degrees.



**180° ANALOG PHASE SHIFTER,
2 - 20 GHz**

Insertion Loss vs. Frequency

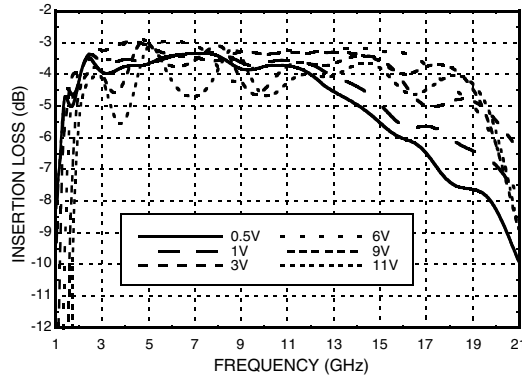

Insertion Loss vs. Vctl, F = 11 GHz

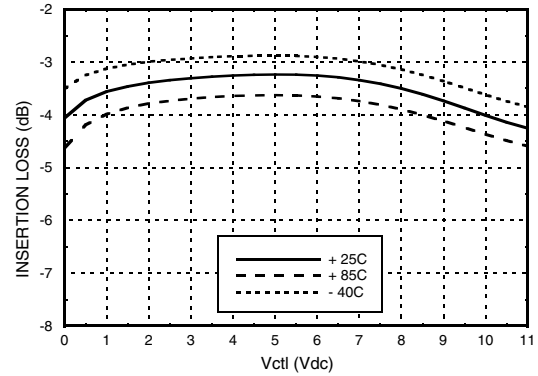

Phase Shift vs. Vctl

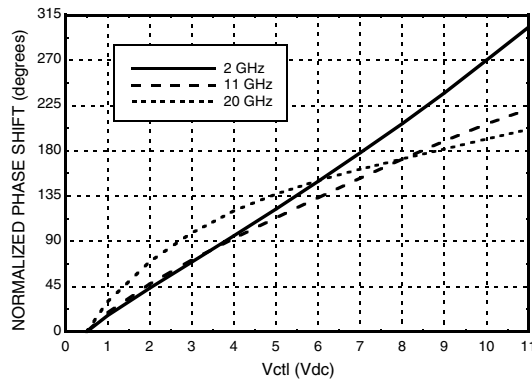

**Phase Shift vs. Frequency @ Vctl = 6V
(Relative to Vctl = 0.5V)**

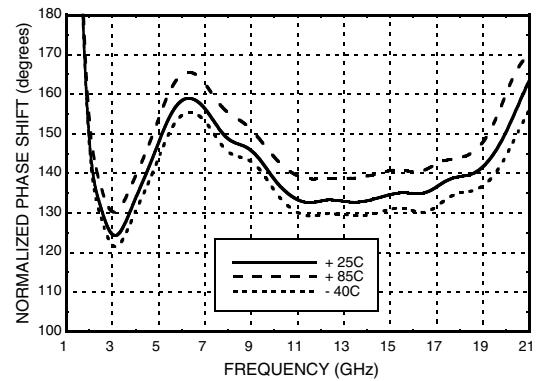

**Phase Shift vs. Frequency
(Relative to Vctl = 0.5V) Vctl = 0.5 to 11V**

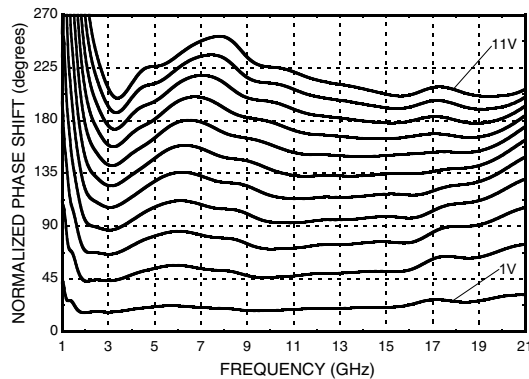

Phase Error vs. Frequency, Fmean = 11 GHz [1]

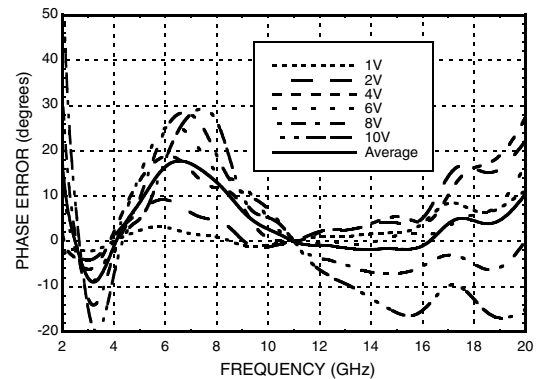

[1] 0 to 10V provides 0 - 180 degrees phase shift range



180° ANALOG PHASE SHIFTER, 2 - 20 GHz

Second Harmonics vs. Vctl, F = 11 GHz

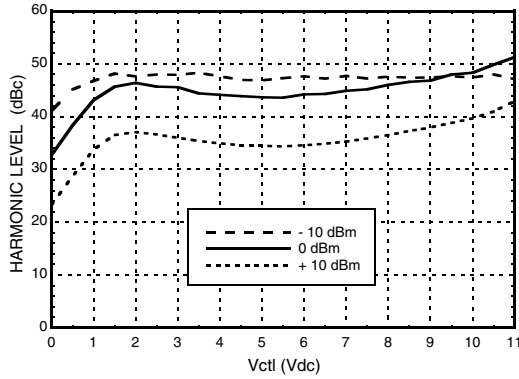

Input IP3 vs. Vctl, F = 11 GHz

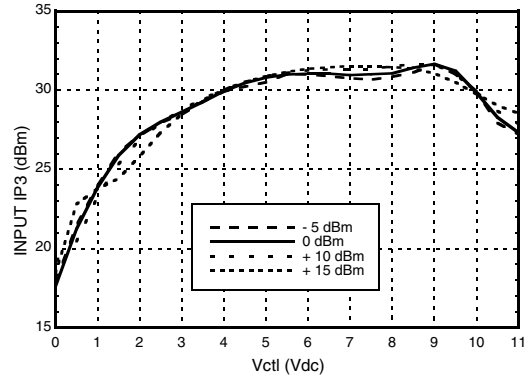

Insertion Loss vs. Pin @ 2 GHz

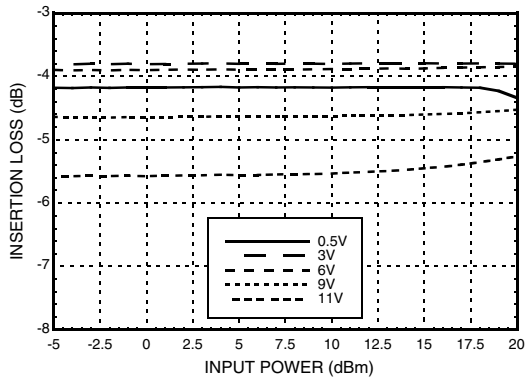

Insertion Loss vs. Pin @ 11 GHz

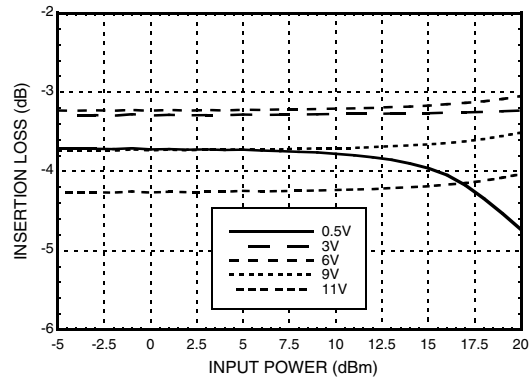

Insertion Loss vs. Pin @ 20 GHz

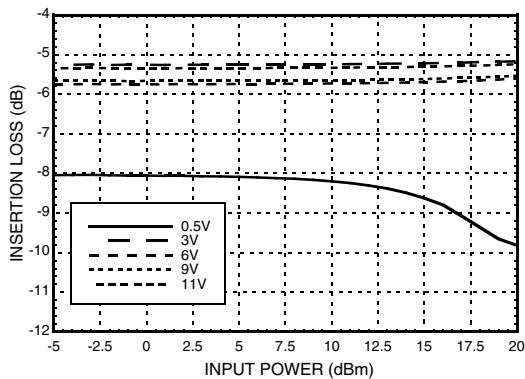

Phase Shift vs. Pin @ 2 GHz

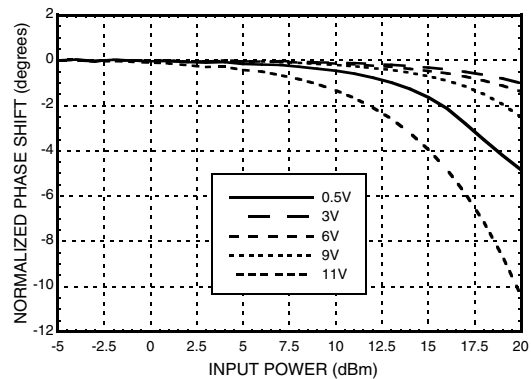

180° ANALOG PHASE SHIFTER, 2 - 20 GHz

Phase Shift vs. Pin @ 11 GHz

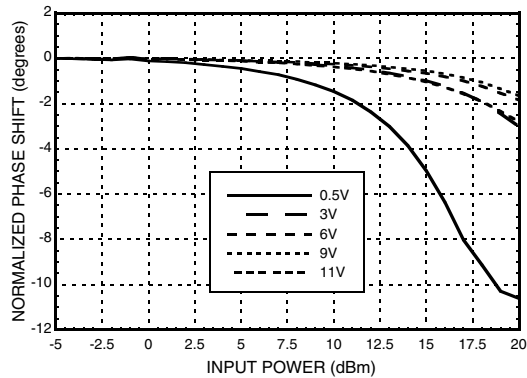

Phase Shift vs. Pin @ 20 GHz

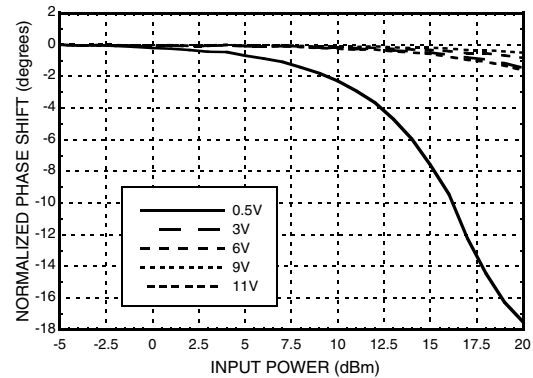

Input Return Loss vs. Frequency, Vctl = 0.5 to +11V

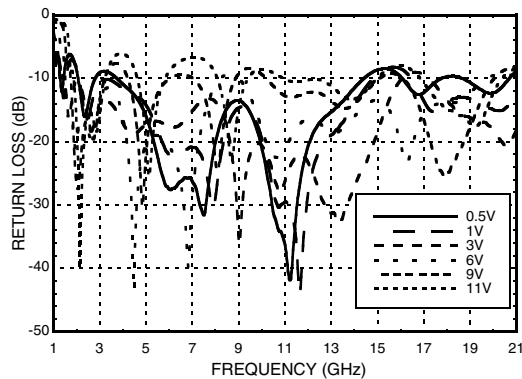

Output Return Loss vs. Frequency, Vctl = 0.5 to +11V

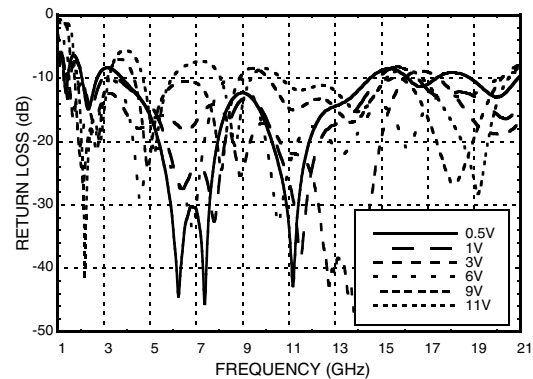

Absolute Maximum Ratings

Frequency Control Voltage (Vctl)	-0.5 to +15V
RF Input Power	26 dBm
Storage Temperature	-65 to +150 °C
ESD Sensitivity (HBM)	Class 1B



**ELECTROSTATIC SENSITIVE DEVICE
OBSERVE HANDLING PRECAUTIONS**

Reliability Information

Junction Temperature To Maintain 1 Million Hour MTTF	150 °C
Nominal Junction Temperature (T = 85 °C and Pin = 10 dBm)	87 °C
Thermal Resistance (Junction To Ground Paddle)	67 °C/W
Operating Temperature	-40 to +85 °C



180° ANALOG PHASE SHIFTER, 2 - 20 GHz

Outline Drawing

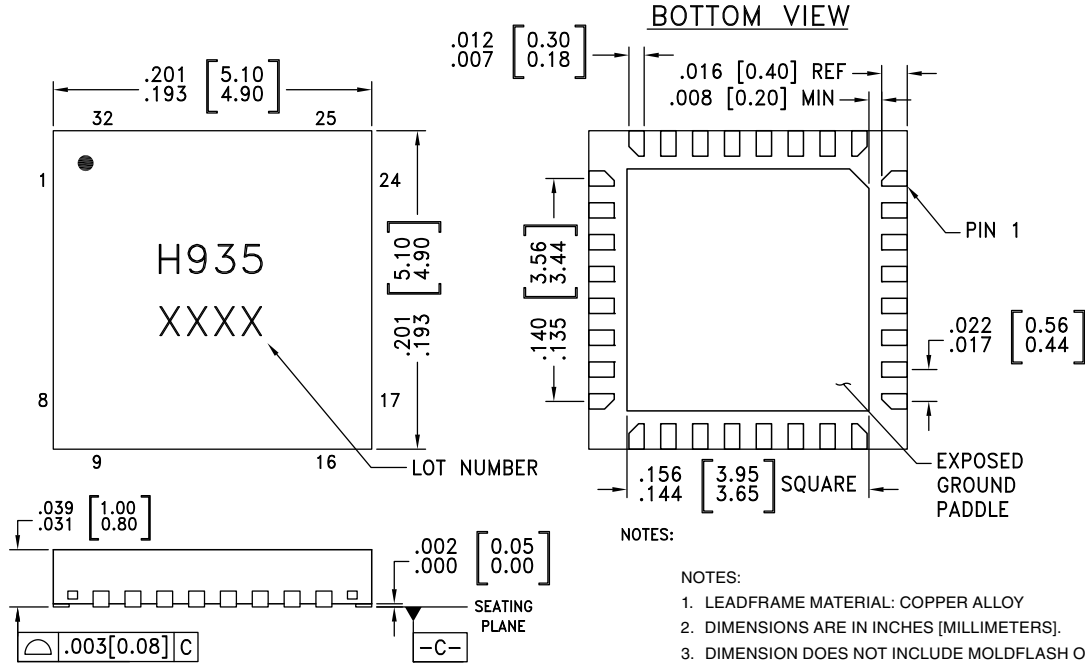

Package Information

Part Number	Package Body Material	Lead Finish	MSL Rating	Package Marking ^[1]
HMC935LP5E	RoHS-Compliant Low Stress Injection Molded Plastic	100% Matte Sn	MSL1 ^[2]	H935 XXXX

[1] 4-Digit lot number XXXX

[2] Max peak reflow temperature of 260 °C

Pin Descriptions

Pin Number	Function	Description	Interface Schematic
1 - 4, 7 - 13, 15 - 18, 21 - 32	N/C	No connection required. These pins may be connected to RF/DC ground without affecting performance.	
5, 20	GND	Ground: Backside of package has exposed metal ground slug that must be connected to ground thru a short path. Vias under the device are required.	
6	RFIN	This pin is AC coupled and matched to 50 Ohms.	
19	RFOUT	This pin is AC coupled and matched to 50 Ohms.	
14	Vctl	Phase shift control pin. Application of a voltage between 0.5 and 11 volts causes the transmission phase to change. The DC equivalent circuit is a series connected diode and resistor.	

For price, delivery and to place orders: Hittite Microwave Corporation, 20 Alpha Road, Chelmsford, MA 01824

Phone: 978-250-3343 Fax: 978-250-3373 Order On-line at www.hittite.com

Application Support: Phone: 978-250-3343 or apps@hittite.com

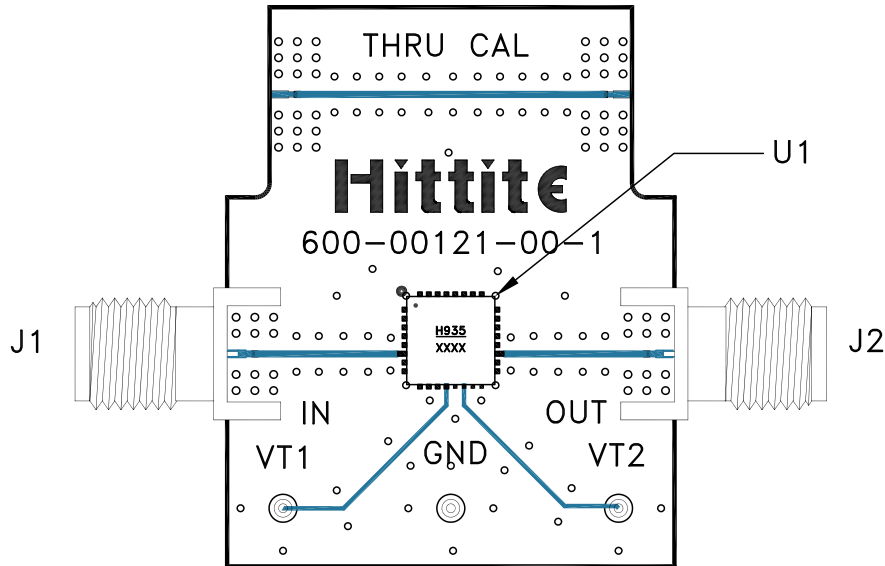
Evaluation PCB

List of Materials for Evaluation PCB EVAL01-HMC935LP5E [1]

Item	Description
J1, J2	Connector, 2.9 mm, 40 GHz Jack
J4, J5	DC Solder Pin
U1	HMC935LP5E Analog Phase Shifter, 2-20 GHz
PCB	600-00121-00, Evaluation PCB

[1] Reference this number when ordering complete evaluation PCB

[2] Circuit Board Material: Rogers 4350 or Arlon 25 FR

The circuit board used in the application should use RF circuit design techniques. Signal lines should have 50 Ohm impedance while the package ground leads and exposed paddle should be connected directly to the ground plane similar to that shown. A sufficient number of via holes should be used to connect the top and bottom ground planes. The evaluation board should be mounted to an appropriate heat sink. The evaluation circuit board shown is available from Hittite upon request.

AMEYA360

Components Supply Platform

Authorized Distribution Brand :



Website :

Welcome to visit www.ameya360.com

Contact Us :

➤ Address :

401 Building No.5, JiuGe Business Center, Lane 2301, Yishan Rd
Minhang District, Shanghai , China

➤ Sales :

Direct +86 (21) 6401-6692

Email amall@ameya360.com

QQ 800077892

Skype [ameyasales1](#) [ameyasales2](#)

➤ Customer Service :

Email service@ameya360.com

➤ Partnership :

Tel +86 (21) 64016692-8333

Email mkt@ameya360.com