

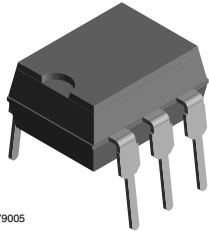

Optocoupler, Photodarlington Output, High Gain, with Base Connection

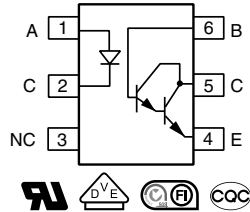

H179005



FEATURES

- Isolation test voltage: 5300 V_{RMS}
- Coupling capacitance, 0.5 pF
- Material categorization:
For definitions of compliance please see www.vishay.com/doc?99912



RoHS COMPLIANT

AGENCY APPROVALS

- UL1577, file no. E52744 system code J
- DIN EN 60747-5-5 (VDE 0884-5) available with option 1
- FIMKO EN60065, EN60950-1
- CQC: GB8898

DESCRIPTION

The H11B1, H11B2, H11B3 are industry standard optocouplers, consisting of a gallium arsenide infrared LED and a silicon photodarlington.

ORDERING INFORMATION									
H	1	1	B	#	-	X	0	0	#
PART NUMBER					PACKAGE OPTION				

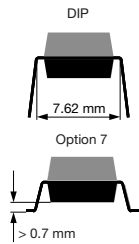
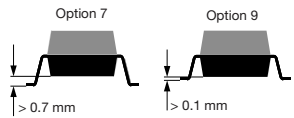
AGENCY CERTIFIED/PACKAGE	CTR (%)		
UL, FIMKO, CQC	> 500	> 200	> 100
DIP-6	H11B1	H11B2	H11B3
SMD-6, option 7	H11B1-X007T ⁽¹⁾	-	-
SMD-6, option 9	H11B1-X009	H11B2-X009T ⁽¹⁾	-
UL, FIMKO, CQC, VDE	> 500	> 200	> 100
SMD-6, option 7	H11B1-X017	-	-

Notes

- Additional options may be possible, please contact sales office.
- ⁽¹⁾ Also available in tubes, no "T" in the end.

ABSOLUTE MAXIMUM RATINGS (T _{amb} = 25 °C, unless otherwise specified)				
PARAMETER	TEST CONDITION	SYMBOL	VALUE	UNIT
INPUT				
Reverse voltage		V _R	3	V
Forward continuous current		I _F	60	mA
Power dissipation		P _{diss}	100	mW
Derate linearly from 25 °C			1.33	mW/°C
OUTPUT				
Collector emitter breakdown voltage		BV _{CEO}	25	V
Emitter collector breakdown voltage		BV _{ECO}	7	V
Collector base breakdown voltage		BV _{CB0}	30	V
Collector current (continuous)		I _C	100	mA
Power dissipation		P _{diss}	150	mW
Derate linearly from 25 °C			2	mW/°C



ABSOLUTE MAXIMUM RATINGS ($T_{amb} = 25\text{ }^{\circ}\text{C}$, unless otherwise specified)				
PARAMETER	TEST CONDITION	SYMBOL	VALUE	UNIT
COUPLER				
Isolation test voltage between emitter and detector		V_{ISO}	5300	V_{RMS}
Creepage distance			≥ 7	mm
Clearance distance			≥ 7	mm
Comparative tracking index per DIN IEC 112/VDE 0303, part 1		CTI	175	
Isolation resistance	$V_{IO} = 500\text{ V}, T_{amb} = 25\text{ }^{\circ}\text{C}$	R_{IO}	$\geq 10^{12}$	Ω
	$V_{IO} = 500\text{ V}, T_{amb} = 100\text{ }^{\circ}\text{C}$	R_{IO}	$\geq 10^{11}$	Ω
Total package dissipation (LED plus detector)		P_{tot}	260	mW
Derate linearly from 25 $^{\circ}\text{C}$			3.5	mW/ $^{\circ}\text{C}$
Storage temperature		T_{stg}	- 55 to + 150	$^{\circ}\text{C}$
Operating temperature		T_{amb}	- 55 to + 100	$^{\circ}\text{C}$
Lead soldering time at 260 $^{\circ}\text{C}$			10	s

Note

- Stresses in excess of the absolute maximum ratings can cause permanent damage to the device. Functional operation of the device is not implied at these or any other conditions in excess of those given in the operational sections of this document. Exposure to absolute maximum ratings for extended periods of the time can adversely affect reliability.

ELECTRICAL CHARACTERISTICS ($T_{amb} = 25\text{ }^{\circ}\text{C}$, unless otherwise specified)							
PARAMETER	TEST CONDITION	PART	SYMBOL	MIN.	TYP.	MAX.	UNIT
INPUT							
Forward voltage	$I_F = 50\text{ mA}$	H11B1	V_F		1.1	1.5	V
		H11B2	V_F		1.1	1.5	V
	$I_F = 10\text{ mA}$	H11B3	V_F		1.1	1.5	V
Reverse current	$V_R = 3\text{ V}$		I_R			10	μA
Junction capacitance	$V_F = 0\text{ V}, f = 1\text{ MHz}$		C_j		50		pF
OUTPUT							
Collector emitter breakdown voltage	$I_C = 1\text{ mA}, I_F = 0\text{ mA}$		BV_{CEO}	30			V
Emitter collector breakdown voltage	$I_E = 100\mu\text{A}, I_F = 0\text{ mA}$		BV_{ECO}	7			V
Collector base breakdown voltage	$I_C = 100\mu\text{A}, I_F = 0\text{ mA}$		BV_{CBO}	30			V
Collector emitter leakage current	$V_{CE} = 10\text{ V}, I_F = 0\text{ mA}$		I_{CEO}			100	nA
COUPLER							
Saturation voltage collector-emitter	$I_F = 1\text{ mA}, I_C = 1\text{ mA}$		V_{CEsat}			1	V
Capacitance (input to output)			C_{IO}		0.5		pF

Note

- Minimum and maximum values were tested requirements. Typical values are characteristics of the device and are the result of engineering evaluations. Typical values are for information only and are not part of the testing requirements.

CURRENT TRANSFER RATIO ($T_{amb} = 25\text{ }^{\circ}\text{C}$, unless otherwise specified)							
PARAMETER	TEST CONDITION	PART	SYMBOL	MIN.	TYP.	MAX.	UNIT
DC current transfer ratio	$V_{CE} = 5\text{ V}, I_F = 1\text{ mA}$	H11B1	CTR_{DC}	500			%
		H11B2	CTR_{DC}	200			%
		H11B3	CTR_{DC}	100			%

SWITCHING CHARACTERISTICS ($T_{amb} = 25\text{ }^{\circ}\text{C}$, unless otherwise specified)							
PARAMETER	TEST CONDITION	SYMBOL	MIN.	TYP.	MAX.	UNIT	
Switching times	$I_F = 5\text{ mA}, V_{CE} = 10\text{ V}, R_L = 100\text{ }\Omega$	t_{on}		5		μs	
		t_{off}		30		μs	



TYPICAL CHARACTERISTICS (T_{amb} = 25 °C, unless otherwise specified)

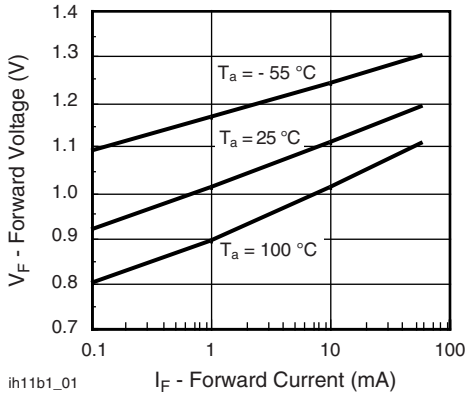

Fig. 1 - Forward Voltage vs. Forward Current

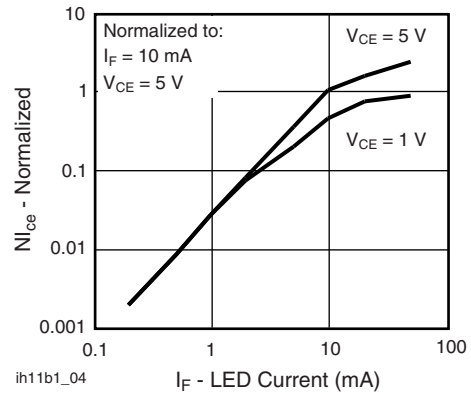

Fig. 4 - Normalized Non-Saturated and Saturated Collector Emitter Current vs. LED Current

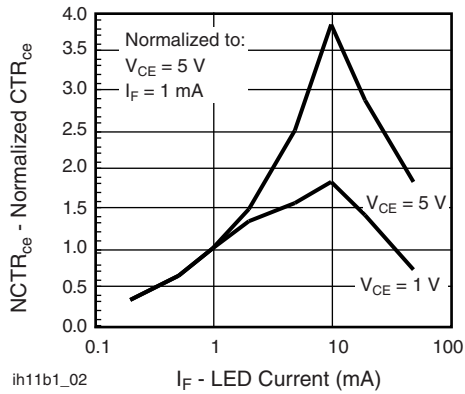

Fig. 2 - Normalized Non-Saturated and Saturated CTR_{CE} vs. LED Current

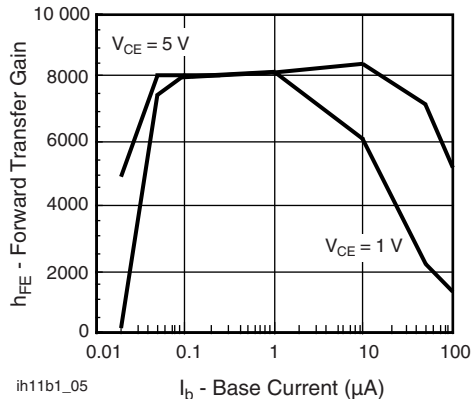

Fig. 5 - Non-Saturated and Saturated h_{FE} vs. Base Current

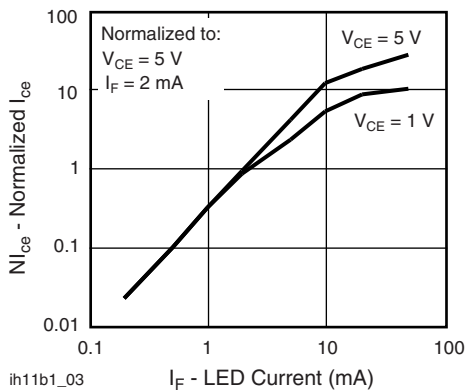

Fig. 3 - Normalized Non-Saturated and Saturated I_{CE} vs. LED Current

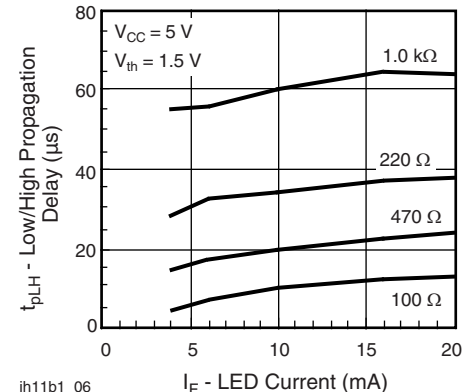

Fig. 6 - Low to High Propagation Delay vs. Collector Load Resistance and LED Current

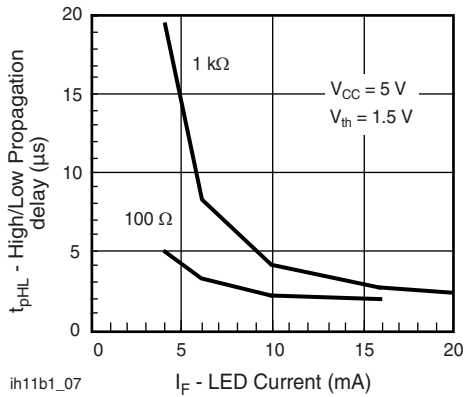
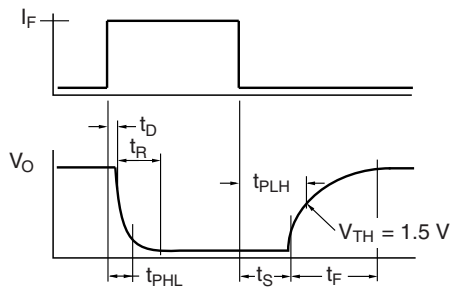
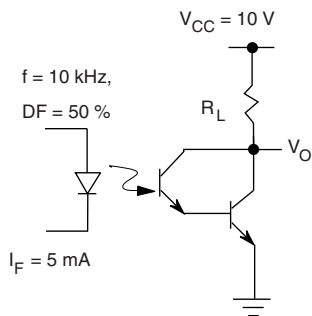

Fig. 7 - High to Low Propagation Delay vs. Collector Load Resistance and LED Current



ih11b1_08

Fig. 8 - Switching Waveform



ih11b1_09

Fig. 9 - Switching Schematic



PACKAGE DIMENSIONS in millimeters

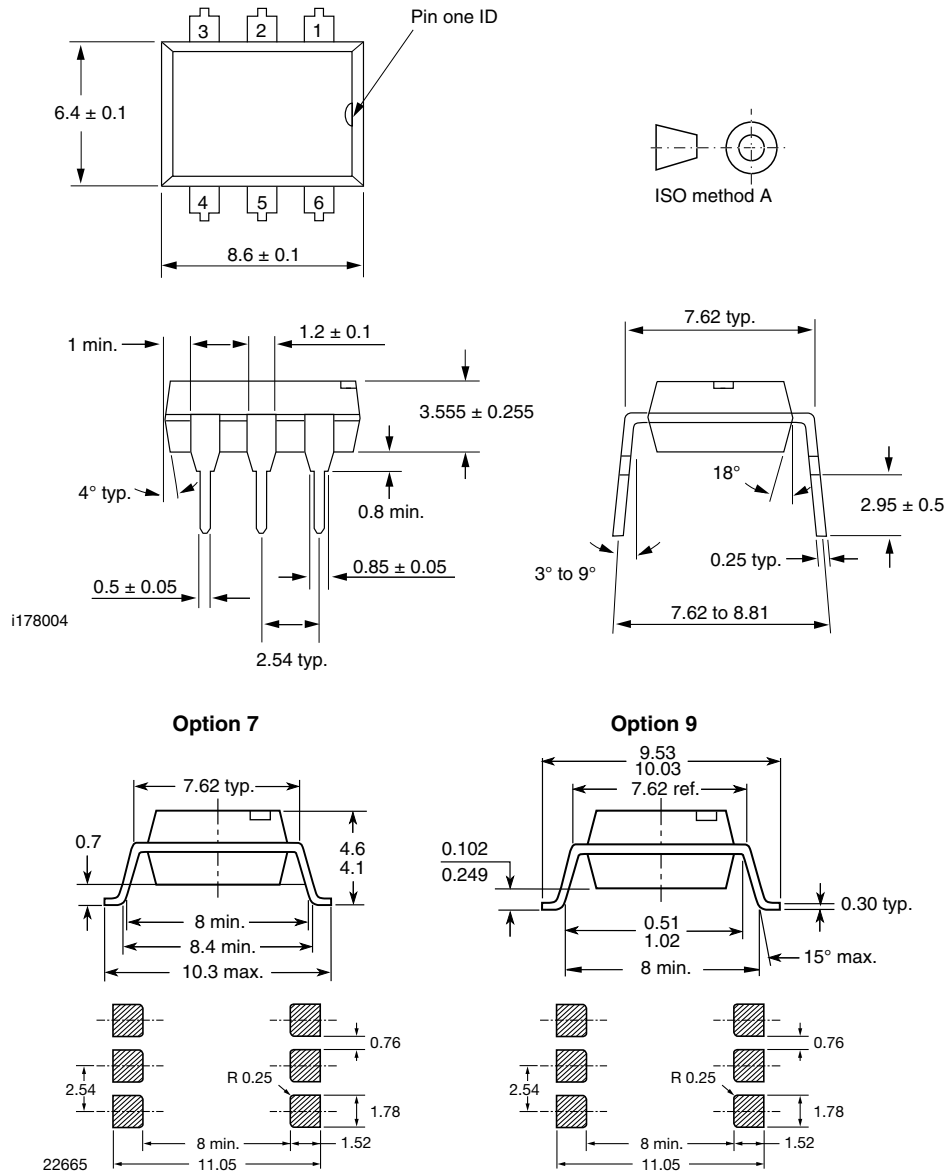

PACKAGE MARKING

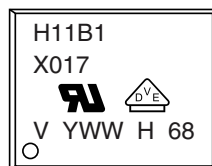

Notes

- Only options 1, 7, and 9 are reflected in the package marking.
- The VDE logo is only marked on option 1 parts.
- Tape and reel suffix (T) is not part of the package marking.



Disclaimer

ALL PRODUCT, PRODUCT SPECIFICATIONS AND DATA ARE SUBJECT TO CHANGE WITHOUT NOTICE TO IMPROVE RELIABILITY, FUNCTION OR DESIGN OR OTHERWISE.

Vishay Intertechnology, Inc., its affiliates, agents, and employees, and all persons acting on its or their behalf (collectively, "Vishay"), disclaim any and all liability for any errors, inaccuracies or incompleteness contained in any datasheet or in any other disclosure relating to any product.

Vishay makes no warranty, representation or guarantee regarding the suitability of the products for any particular purpose or the continuing production of any product. To the maximum extent permitted by applicable law, Vishay disclaims (i) any and all liability arising out of the application or use of any product, (ii) any and all liability, including without limitation special, consequential or incidental damages, and (iii) any and all implied warranties, including warranties of fitness for particular purpose, non-infringement and merchantability.

Statements regarding the suitability of products for certain types of applications are based on Vishay's knowledge of typical requirements that are often placed on Vishay products in generic applications. Such statements are not binding statements about the suitability of products for a particular application. It is the customer's responsibility to validate that a particular product with the properties described in the product specification is suitable for use in a particular application. Parameters provided in datasheets and/or specifications may vary in different applications and performance may vary over time. All operating parameters, including typical parameters, must be validated for each customer application by the customer's technical experts. Product specifications do not expand or otherwise modify Vishay's terms and conditions of purchase, including but not limited to the warranty expressed therein.

Except as expressly indicated in writing, Vishay products are not designed for use in medical, life-saving, or life-sustaining applications or for any other application in which the failure of the Vishay product could result in personal injury or death. Customers using or selling Vishay products not expressly indicated for use in such applications do so at their own risk. Please contact authorized Vishay personnel to obtain written terms and conditions regarding products designed for such applications.

No license, express or implied, by estoppel or otherwise, to any intellectual property rights is granted by this document or by any conduct of Vishay. Product names and markings noted herein may be trademarks of their respective owners.

Material Category Policy

Vishay Intertechnology, Inc. hereby certifies that all its products that are identified as RoHS-Compliant fulfill the definitions and restrictions defined under Directive 2011/65/EU of The European Parliament and of the Council of June 8, 2011 on the restriction of the use of certain hazardous substances in electrical and electronic equipment (EEE) - recast, unless otherwise specified as non-compliant.

Please note that some Vishay documentation may still make reference to RoHS Directive 2002/95/EC. We confirm that all the products identified as being compliant to Directive 2002/95/EC conform to Directive 2011/65/EU.

Vishay Intertechnology, Inc. hereby certifies that all its products that are identified as Halogen-Free follow Halogen-Free requirements as per JEDEC JS709A standards. Please note that some Vishay documentation may still make reference to the IEC 61249-2-21 definition. We confirm that all the products identified as being compliant to IEC 61249-2-21 conform to JEDEC JS709A standards.

AMEYA360

Components Supply Platform

Authorized Distribution Brand :



Website :

Welcome to visit www.ameya360.com

Contact Us :

➤ Address :

401 Building No.5, JiuGe Business Center, Lane 2301, Yishan Rd
Minhang District, Shanghai , China

➤ Sales :

Direct +86 (21) 6401-6692

Email amall@ameya360.com

QQ 800077892

Skype [ameyasales1](#) [ameyasales2](#)

➤ Customer Service :

Email service@ameya360.com

➤ Partnership :

Tel +86 (21) 64016692-8333

Email mkt@ameya360.com