

## Features

- Peak pulse power:
  - 3000 W (10/1000  $\mu$ s)
- Stand off voltage range: from 5 V to 33 V
- Unidirectional and bidirectional types
- Low leakage current: 0.2  $\mu$ A
- Operating  $T_{j\max}$ : 150 °C
- High power capability at  $T_{j\max}$ :
  - 2200 W (10/1000  $\mu$ s)
- JEDEC registered package outline

## Complies with the following standards

- IEC 61000-4-2 level 4
  - 15 kV (air discharge)
  - 8 kV (contact discharge)
- MIL STD 883G, method 3015-7 Class 3B
  - 25 kV HBM (human body model)
- Resin meets UL 94, V0
- MIL-STD-750, method 2026 solderability
- EIA STD RS-481 and IEC 60286-3 packing
- IPC 7531 footprint

## Description

The SMC30J Transil series has been designed to protect sensitive equipment against surges below 3000 W (10/1000  $\mu$ s) and against electro-static discharges according to IEC 61000-4-2, and MIL STD 883, method 3015.

The Planar technology makes it compatible with high-end equipment and SMPS where low leakage current and high junction temperature are required to provide reliability and stability over time. SMC30J are packaged in SMC (SMC footprint in accordance with IPC 7531 standard).

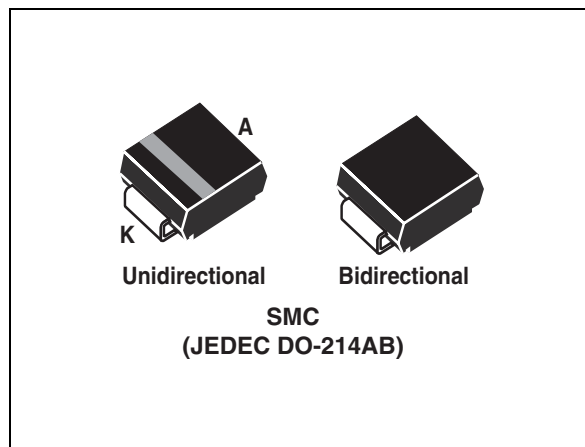

**TM:** Transil is a trademark of STMicroelectronics

# 1 Characteristics

**Table 1. Absolute maximum ratings ( $T_{amb} = 25\text{ }^{\circ}\text{C}$ )**

Symbol	Parameter	Value	Unit
$P_{PP}$	Peak pulse power dissipation <sup>(1)</sup>	$T_j$ initial = $T_{amb}$ 3000	W
$T_{stg}$	Storage temperature range	-65 to +150	$^{\circ}\text{C}$
$T_j$	Operating junction temperature range	-55 to +150	$^{\circ}\text{C}$
$T_L$	Maximum lead temperature for soldering during 10 s.	260	$^{\circ}\text{C}$

1. For a surge greater than the maximum values, the diode will fail in short-circuit.

**Table 2. Thermal resistances**

Symbol	Parameter	Value	Unit
$R_{th(j-l)}$	Junction to leads	15	$^{\circ}\text{C/W}$
$R_{th(j-a)}$	Junction to ambient on printed circuit on recommended pad layout	90	$^{\circ}\text{C/W}$

**Figure 1. Electrical characteristics - definitions**

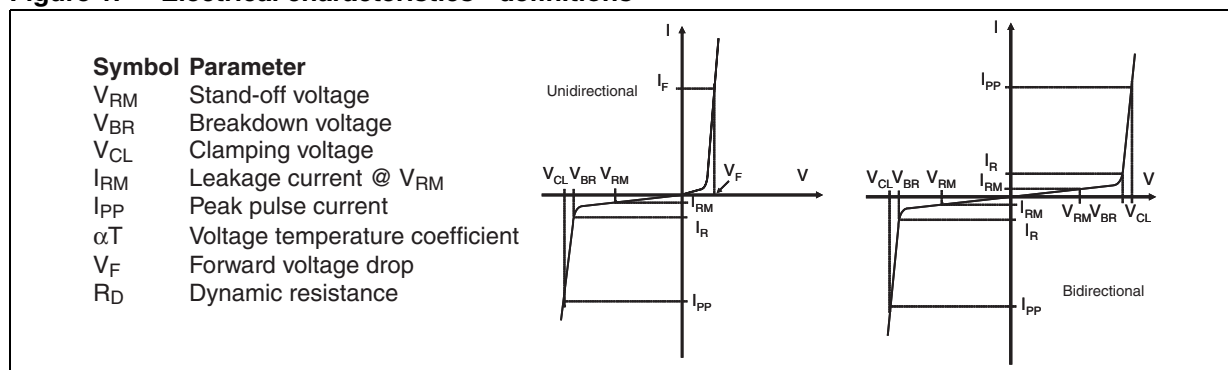

**Figure 2. Pulse definition for electrical characteristics**

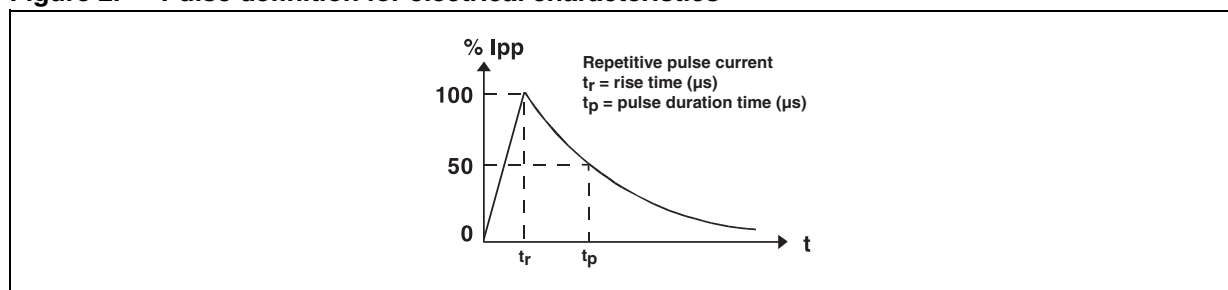

Table 3. Electrical characteristics - parameter values ( $T_{amb} = 25\text{ °C}$ )

Order code	$I_{RM\ max}@V_{RM}$		$V_{BR}\ @I_R^{(1)}$			$V_{CL}\ @I_{PP}\ 10/1000\ \mu s$		$R_D^{(2)}\ 10/1000\ \mu s$	$\alpha T^{(3)}$
			min	typ		max			
	$\mu A$	V	V		mA	V	A <sup>(4)</sup>	$\Omega$	10-4/ °C
SMC30J5.0A/CA	500	5	6.4	6.74	10	9.2	327	0.008	5.7
SMC30J6.0A/CA	500	6	6.7	7.05	10	10.3	291	0.011	5.9
SMC30J6.5A/CA	250	6.5	7.2	7.58	10	11.2	268	0.014	6.1
SMC30J8.5A/CA	10	8.5	9.4	9.9	1	14.4	208	0.022	7.3
SMC30J10A/CA	0.2	10	11.1	11.7	1	17	176	0.030	7.8
SMC30J12A/CA	0.2	12	13.3	14	1	19.9	151	0.039	8.3
SMC30J13A/CA	0.2	13	14.4	15.2	1	21.5	140	0.045	8.4
SMC30J15A/CA	0.2	15	16.7	17.6	1	24.4	123	0.055	8.8
SMC30J16A/CA	0.2	16	17.8	18.7	1	26	115	0.063	8.8
SMC30J18A/CA	0.2	18	20	21.1	1	29.2	103	0.079	9.2
SMC30J20A/CA	0.2	20	22.2	23.4	1	32.4	93	0.097	9.4
SMC30J22A/CA	0.2	22	24.4	25.7	1	35.5	85	0.115	9.6
SMC30J24A/CA	0.2	24	26.7	28.1	1	38.9	77	0.140	9.6
SMC30J26A/CA	0.2	26	28.9	30.4	1	42.1	71	0.165	9.7
SMC30J28A/CA	0.2	28	31.1	32.7	1	45.4	66	0.192	9.8
SMC30J30A/CA	0.2	30	33.3	35.1	1	48.4	62	0.215	9.9
SMC30J33A/CA	0.2	33	36.7	38.6	1	53.3	56	0.261	10.0

1. Pulse test :  $t_p < 50\ ms$

2. To calculate maximum clamping voltage at other surge level, use the following formula:  $V_{CLmax} = V_{CL} - R_D \times (I_{PP} - I_{PPappli})$   
where  $I_{PPappli}$  is the surge current in the application

3. To calculate  $V_{BR}$  or  $V_{CL}$  versus junction temperature, use the following formulas:

$$V_{BR} @ T_J = V_{BR} @ 25\text{ °C} \times (1 + \alpha T \times (T_J - 25))$$

$$V_{CL} @ T_J = V_{CL} @ 25\text{ °C} \times (1 + \alpha T \times (T_J - 25))$$

4. Surge capability given for both directions for unidirectional and bidirectional types.

**Figure 3. Peak pulse power dissipation versus initial junction temperature (typical value)**

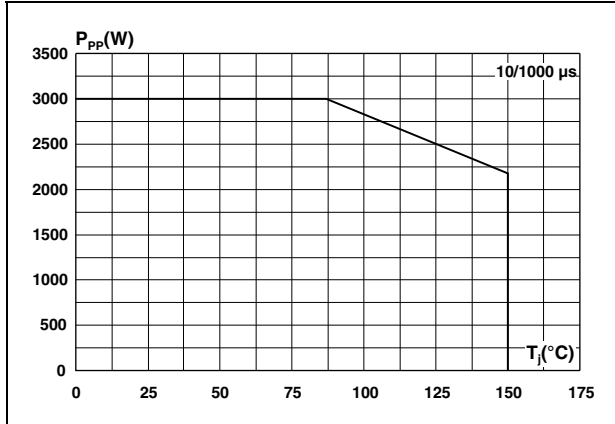

**Figure 4. Peak pulse power versus exponential pulse duration (T<sub>j</sub> initial = 25 °C)**

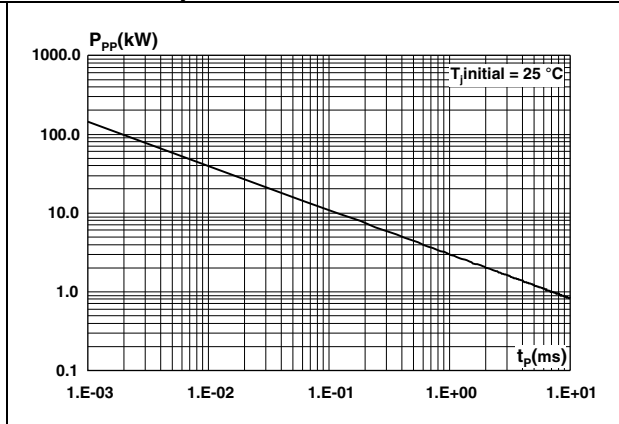

**Figure 5. Clamping voltage versus peak pulse current (exponential waveform, maximum values)**

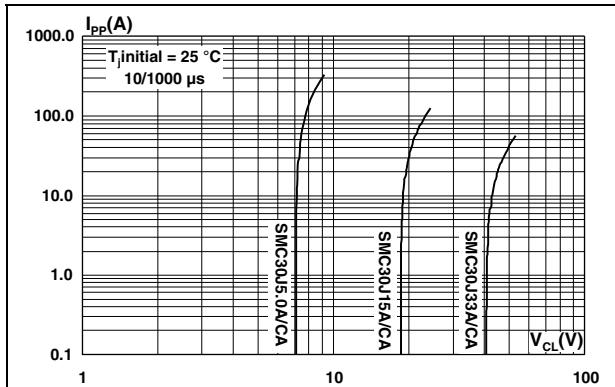

**Figure 6. Junction capacitance versus reverse applied voltage for unidirectional types (typical values)**

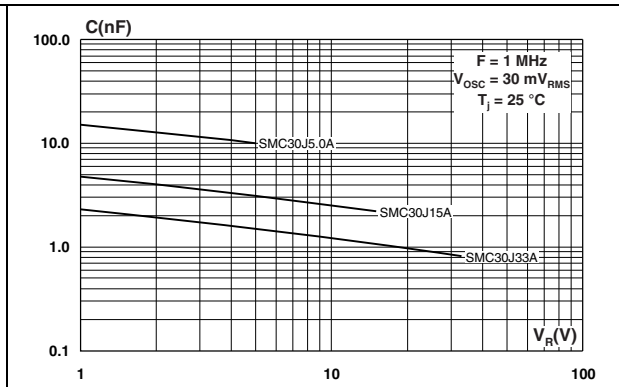

**Figure 7. Junction capacitance versus reverse applied voltage for bidirectional types (typical values)**

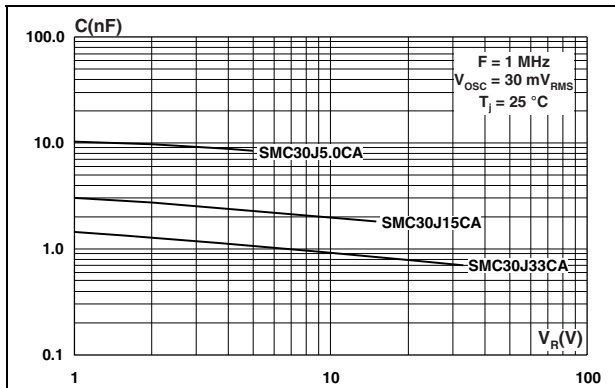

**Figure 8. Peak forward voltage drop versus peak forward current (typical values)**

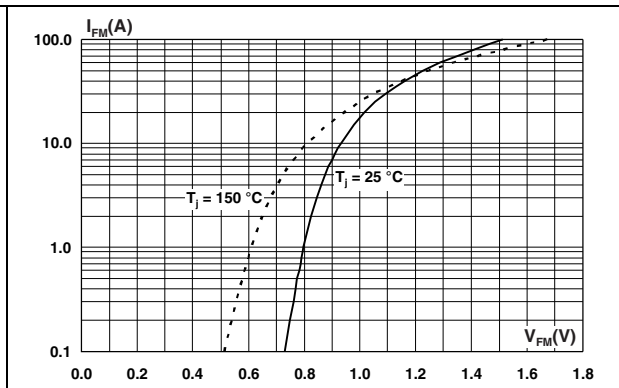

Figure 9. Relative variation of thermal impedance, junction to ambient, versus pulse duration

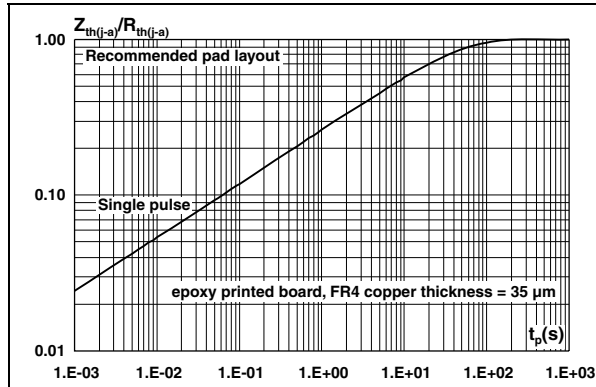

Figure 10. Thermal resistance junction to ambient versus copper surface under each lead

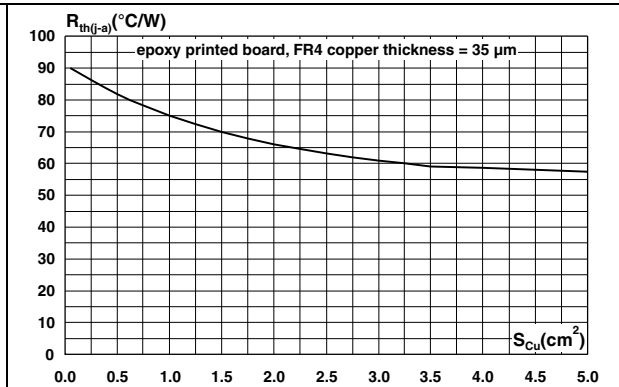
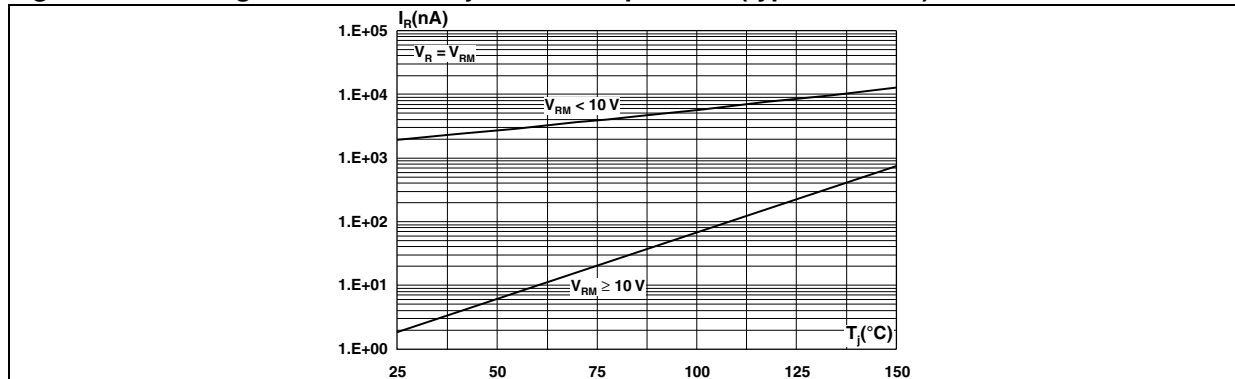
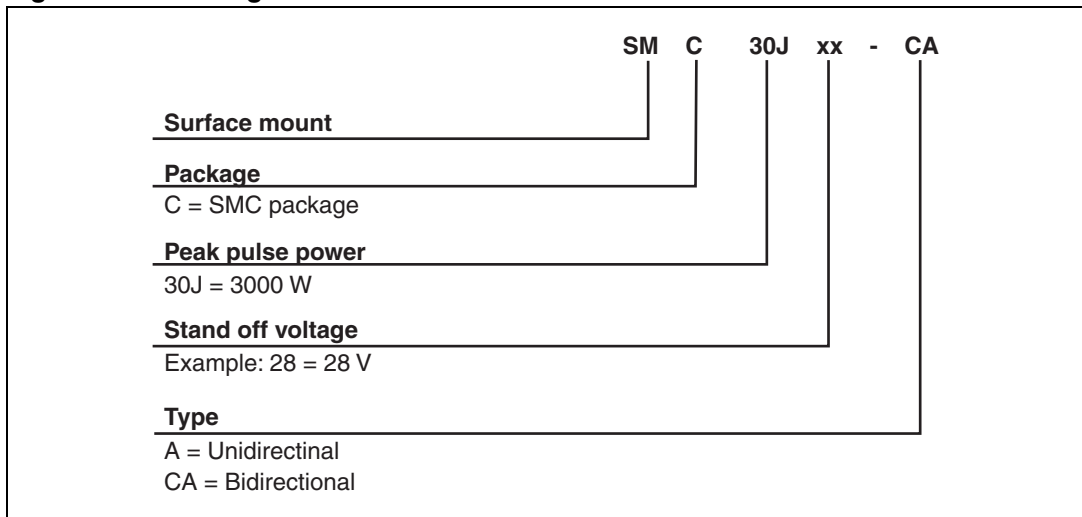

Figure 11. Leakage current versus junction temperature (typical values)



## 2 Ordering information scheme

Figure 12. Ordering information scheme



### 3 Package information

- Case: JEDEC DO-214AB molded plastic over planar junction
- Terminals: solder plated, solderable per MIL-STD-750, Method 2026
- Polarity: for unidirectional types the band indicates cathode
- Flammability: epoxy is rated UL94V-0
- RoHS package

In order to meet environmental requirements, ST offers these devices in different grades of ECOPACK® packages, depending on their level of environmental compliance. ECOPACK® specifications, grade definitions and product status are available at: [www.st.com](http://www.st.com). ECOPACK® is an ST trademark.

**Table 4. SMC dimensions**

Ref.	dimensions			
	Millimeters		Inches	
	Min.	Max.	Min.	Max.
A1	1.90	2.45	0.075	0.096
A2	0.05	0.20	0.002	0.008
b	2.90	3.2	0.114	0.126
c	0.15	0.41	0.006	0.016
E	7.75	8.15	0.305	0.321
E1	6.60	7.15	0.260	0.281
E2	4.40	4.70	0.173	0.185
D	5.55	6.25	0.218	0.246
L	0.75	1.60	0.030	0.063

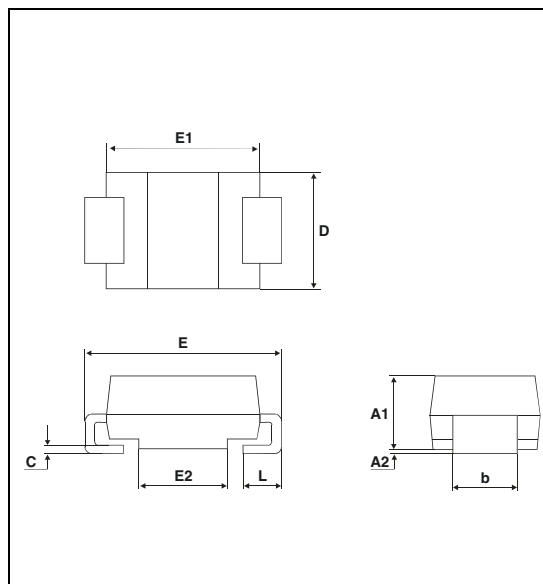

**Figure 13. Footprint dimensions mm (inches)**

**Figure 14. Marking layout<sup>(1)</sup>**

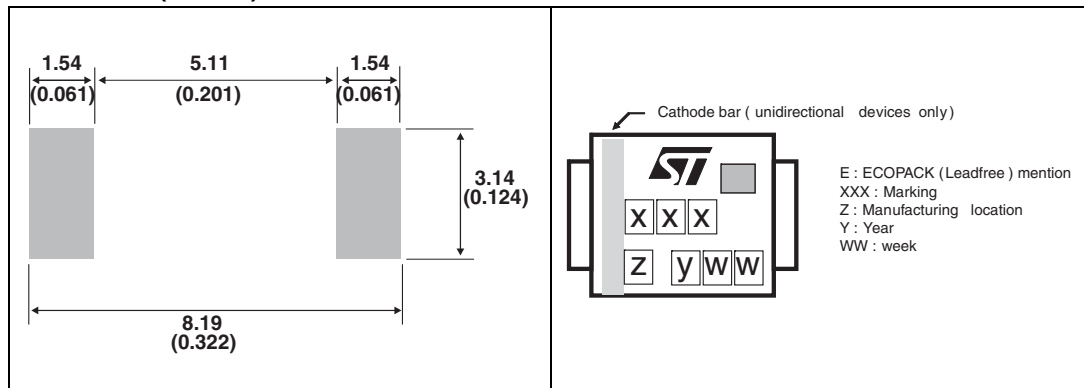

1. Marking layout can vary according to assembly location.

**Table 5. Marking**

Order code	Marking	Order code	Marking
SMC30J5.0A	3AAA	SMC30J5.0CA	3BAA
SMC30J6.0A	3AAB	SMC30J6.0CA	3BAB
SMC30J6.5A	3AAC	SMC30J6.5CA	3BAC
SMC30J8.5A	3AAD	SMC30J8.5CA	3BAD
SMC30J10A	3AAE	SMC30J10CA	3BAE
SMC30J12A	3AAF	SMC30J12CA	3BAF
SMC30J13A	3AAG	SMC30J13CA	3BAG
SMC30J15A	3AAH	SMC30J15CA	3BAH
SMC30J16A	3AAI	SMC30J16CA	3BAI
SMC30J18A	3AAJ	SMC30J18CA	3BAJ
SMC30J20A	3AAK	SMC30J20CA	3BAK
SMC30J22A	3AAL	SMC30J22CA	3BAL
SMC30J24A	3AAE	SMC30J24CA	3BAE
SMC30J26A	3AAM	SMC30J26CA	3BAM
SMC30J28A	3AAN	SMC30J28CA	3BAN
SMC30J30A	3AAO	SMC30J30CA	3BAO
SMC30J33A	3AAP	SMC30J33CA	3BAP



## 4 Ordering information

**Table 6. Ordering information**

Order code	Marking	Package	Weight	Base qty	Delivery mode
SMC30JxxxA/CA <sup>(1)</sup>	See <a href="#">Table 5 on page 8</a>	SMC	0.25 g	2500	Tape and reel

1. Where xxx is nominal value of  $V_{BR}$  and A or CA indicates unidirectional or bidirectional version. See [Table 3](#) for list of available devices and their order codes

## 5 Revision history

**Table 7. Document revision history**

Date	Revision	Changes
28-Jul-2011	1	Initial release.

**Please Read Carefully:**

Information in this document is provided solely in connection with ST products. STMicroelectronics NV and its subsidiaries ("ST") reserve the right to make changes, corrections, modifications or improvements, to this document, and the products and services described herein at any time, without notice.

All ST products are sold pursuant to ST's terms and conditions of sale.

Purchasers are solely responsible for the choice, selection and use of the ST products and services described herein, and ST assumes no liability whatsoever relating to the choice, selection or use of the ST products and services described herein.

No license, express or implied, by estoppel or otherwise, to any intellectual property rights is granted under this document. If any part of this document refers to any third party products or services it shall not be deemed a license grant by ST for the use of such third party products or services, or any intellectual property contained therein or considered as a warranty covering the use in any manner whatsoever of such third party products or services or any intellectual property contained therein.

**UNLESS OTHERWISE SET FORTH IN ST'S TERMS AND CONDITIONS OF SALE ST DISCLAIMS ANY EXPRESS OR IMPLIED WARRANTY WITH RESPECT TO THE USE AND/OR SALE OF ST PRODUCTS INCLUDING WITHOUT LIMITATION IMPLIED WARRANTIES OF MERCHANTABILITY, FITNESS FOR A PARTICULAR PURPOSE (AND THEIR EQUIVALENTS UNDER THE LAWS OF ANY JURISDICTION), OR INFRINGEMENT OF ANY PATENT, COPYRIGHT OR OTHER INTELLECTUAL PROPERTY RIGHT.**

**UNLESS EXPRESSLY APPROVED IN WRITING BY TWO AUTHORIZED ST REPRESENTATIVES, ST PRODUCTS ARE NOT RECOMMENDED, AUTHORIZED OR WARRANTED FOR USE IN MILITARY, AIR CRAFT, SPACE, LIFE SAVING, OR LIFE SUSTAINING APPLICATIONS, NOR IN PRODUCTS OR SYSTEMS WHERE FAILURE OR MALFUNCTION MAY RESULT IN PERSONAL INJURY, DEATH, OR SEVERE PROPERTY OR ENVIRONMENTAL DAMAGE. ST PRODUCTS WHICH ARE NOT SPECIFIED AS "AUTOMOTIVE GRADE" MAY ONLY BE USED IN AUTOMOTIVE APPLICATIONS AT USER'S OWN RISK.**

Resale of ST products with provisions different from the statements and/or technical features set forth in this document shall immediately void any warranty granted by ST for the ST product or service described herein and shall not create or extend in any manner whatsoever, any liability of ST.

ST and the ST logo are trademarks or registered trademarks of ST in various countries.

Information in this document supersedes and replaces all information previously supplied.

The ST logo is a registered trademark of STMicroelectronics. All other names are the property of their respective owners.

© 2011 STMicroelectronics - All rights reserved

STMicroelectronics group of companies

Australia - Belgium - Brazil - Canada - China - Czech Republic - Finland - France - Germany - Hong Kong - India - Israel - Italy - Japan - Malaysia - Malta - Morocco - Philippines - Singapore - Spain - Sweden - Switzerland - United Kingdom - United States of America

[www.st.com](http://www.st.com)

# AMEYA360

## Components Supply Platform

Authorized Distribution Brand :



Website :

Welcome to visit [www.ameya360.com](http://www.ameya360.com)

Contact Us :

➤ Address :

401 Building No.5, JiuGe Business Center, Lane 2301, Yishan Rd  
Minhang District, Shanghai , China

➤ Sales :

Direct +86 (21) 6401-6692

Email [amall@ameya360.com](mailto:amall@ameya360.com)

QQ 800077892

Skype [ameyasales1](#) [ameyasales2](#)

➤ Customer Service :

Email [service@ameya360.com](mailto:service@ameya360.com)

➤ Partnership :

Tel +86 (21) 64016692-8333

Email [mkt@ameya360.com](mailto:mkt@ameya360.com)