

## Features

- Utilizes the AVR<sup>®</sup> RISC Architecture
- High-performance and Low-power 8-bit RISC Architecture
  - 90 Powerful Instructions – Most Single Clock Cycle Execution
  - 32 x 8 General Purpose Working Registers
  - Up to 8 MIPS Throughput at 8 MHz
- Nonvolatile Program and Data Memory
  - 1K Byte of Flash Program Memory
    - In-System Programmable (ATtiny12)
    - Endurance: 1,000 Write/Erase Cycles (ATtiny11/12)
  - 64 Bytes of In-System Programmable EEPROM Data Memory for ATtiny12
    - Endurance: 100,000 Write/Erase Cycles
  - Programming Lock for Flash Program and EEPROM Data Security
- Peripheral Features
  - Interrupt and Wake-up on Pin Change
  - One 8-bit Timer/Counter with Separate Prescaler
  - On-chip Analog Comparator
  - Programmable Watchdog Timer with On-chip Oscillator
- Special Microcontroller Features
  - Low-power Idle and Power-down Modes
  - External and Internal Interrupt Sources
  - In-System Programmable via SPI Port (ATtiny12)
  - Enhanced Power-on Reset Circuit (ATtiny12)
  - Internal Calibrated RC Oscillator (ATtiny12)
- Specification
  - Low-power, High-speed CMOS Process Technology
  - Fully Static Operation
- Power Consumption at 4 MHz, 3V, 25°C
  - Active: 2.2 mA
  - Idle Mode: 0.5 mA
  - Power-down Mode: <1 μA
- Packages
  - 8-pin PDIP and SOIC
- Operating Voltages
  - 1.8 - 5.5V for ATtiny12V-1
  - 2.7 - 5.5V for ATtiny11L-2 and ATtiny12L-4
  - 4.0 - 5.5V for ATtiny11-6 and ATtiny12-8
- Speed Grades
  - 0 - 1.2 MHz (ATtiny12V-1)
  - 0 - 2 MHz (ATtiny11L-2)
  - 0 - 4 MHz (ATtiny12L-4)
  - 0 - 6 MHz (ATtiny11-6)
  - 0 - 8 MHz (ATtiny12-8)

## Pin Configuration

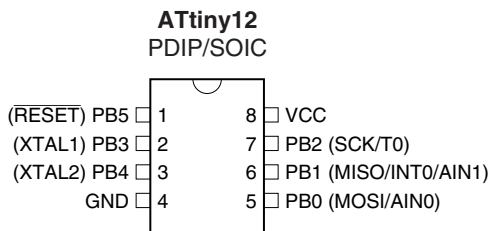
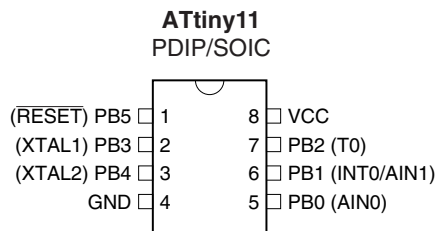

## 8-bit AVR<sup>®</sup> Microcontroller with 1K Byte Flash

ATtiny11  
ATtiny12

## Summary

Not recommended for new design

Rev. 1006FS-AVR-06/07



Note: This is a summary document. A complete document is available on our Web site at [www.atmel.com](http://www.atmel.com).



## Overview

The ATtiny11/12 is a low-power CMOS 8-bit microcontroller based on the AVR RISC architecture. By executing powerful instructions in a single clock cycle, the ATtiny11/12 achieves throughputs approaching 1 MIPS per MHz, allowing the system designer to optimize power consumption versus processing speed.

The AVR core combines a rich instruction set with 32 general-purpose working registers. All the 32 registers are directly connected to the Arithmetic Logic Unit (ALU), allowing two independent registers to be accessed in one single instruction executed in one clock cycle. The resulting architecture is more code efficient while achieving throughputs up to ten times faster than conventional CISC microcontrollers.

**Table 1.** Parts Description

Device	Flash	EEPROM	Register	Voltage Range	Frequency
ATtiny11L	1K	-	32	2.7 - 5.5V	0-2 MHz
ATtiny11	1K	-	32	4.0 - 5.5V	0-6 MHz
ATtiny12V	1K	64 B	32	1.8 - 5.5V	0-1.2 MHz
ATtiny12L	1K	64 B	32	2.7 - 5.5V	0-4 MHz
ATtiny12	1K	64 B	32	4.0 - 5.5V	0-8 MHz

The ATtiny11/12 AVR is supported with a full suite of program and system development tools including: macro assemblers, program debugger/simulators, in-circuit emulators, and evaluation kits.

## ATtiny11 Block Diagram

See Figure 1 on page 3. The ATtiny11 provides the following features: 1K bytes of Flash, up to five general-purpose I/O lines, one input line, 32 general-purpose working registers, an 8-bit timer/counter, internal and external interrupts, programmable Watchdog Timer with internal oscillator, and two software-selectable power-saving modes. The Idle Mode stops the CPU while allowing the timer/counters and interrupt system to continue functioning. The Power-down Mode saves the register contents but freezes the oscillator, disabling all other chip functions until the next interrupt or hardware reset. The wake-up or interrupt on pin change features enable the ATtiny11 to be highly responsive to external events, still featuring the lowest power consumption while in the power-down modes.

The device is manufactured using Atmel's high-density nonvolatile memory technology. By combining an RISC 8-bit CPU with Flash on a monolithic chip, the Atmel ATtiny11 is a powerful microcontroller that provides a highly-flexible and cost-effective solution to many embedded control applications.

**Figure 1.** The ATtiny11 Block Diagram

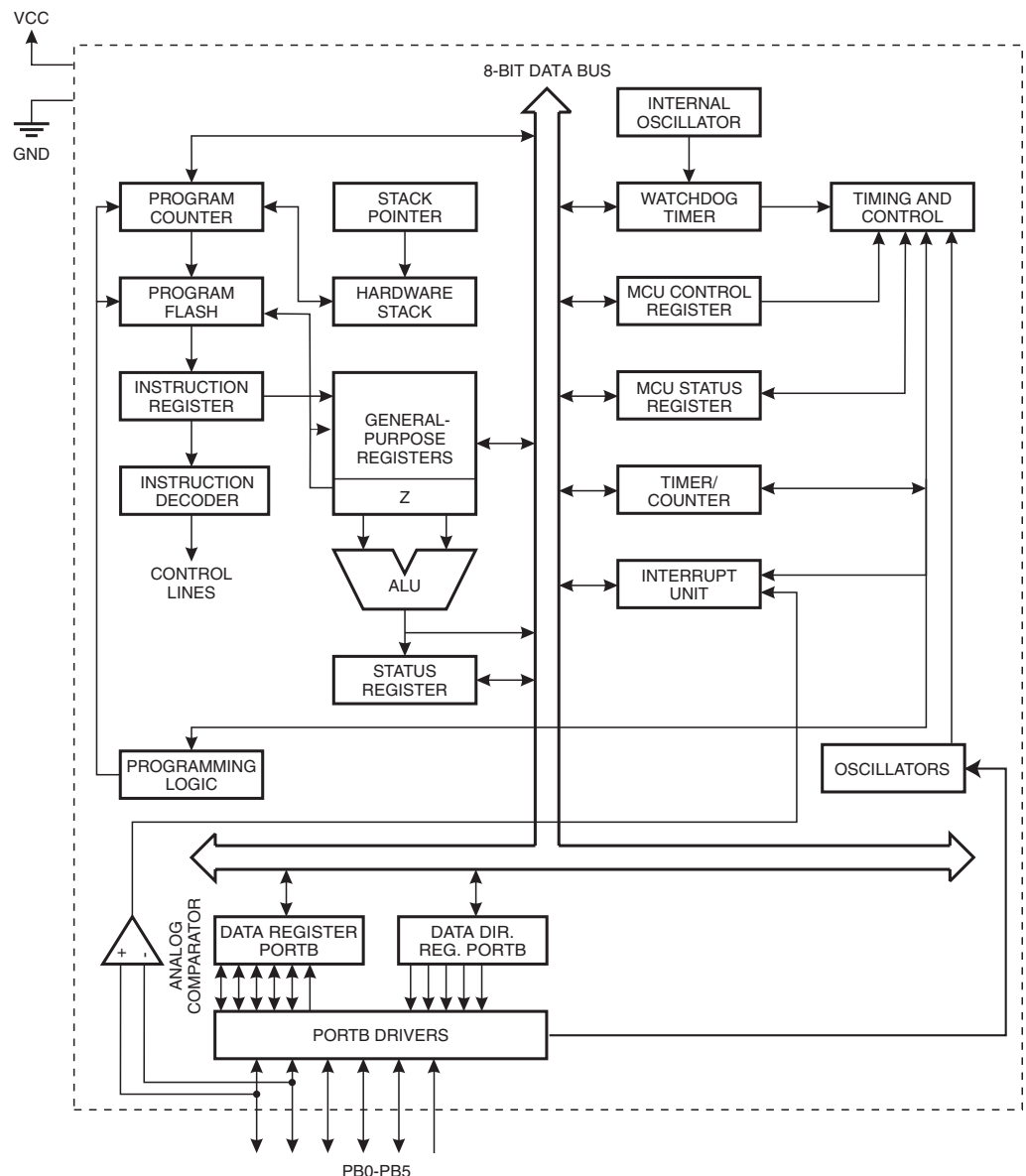

## ATtiny12 Block Diagram

Figure 2 on page 4. The ATtiny12 provides the following features: 1K bytes of Flash, 64 bytes EEPROM, up to six general-purpose I/O lines, 32 general-purpose working registers, an 8-bit timer/counter, internal and external interrupts, programmable Watchdog Timer with internal oscillator, and two software-selectable power-saving modes. The Idle Mode stops the CPU while allowing the timer/counters and interrupt system to continue functioning. The Power-down Mode saves the register contents but freezes the oscillator, disabling all other chip functions until the next interrupt or hardware reset. The wake-up or interrupt on pin change features enable the ATtiny12 to be highly responsive to external events, still featuring the lowest power consumption while in the power-down modes.

The device is manufactured using Atmel's high-density nonvolatile memory technology. By combining an RISC 8-bit CPU with Flash on a monolithic chip, the Atmel ATtiny12 is a powerful microcontroller that provides a highly-flexible and cost-effective solution to many embedded control applications.

**Figure 2.** The ATtiny12 Block Diagram

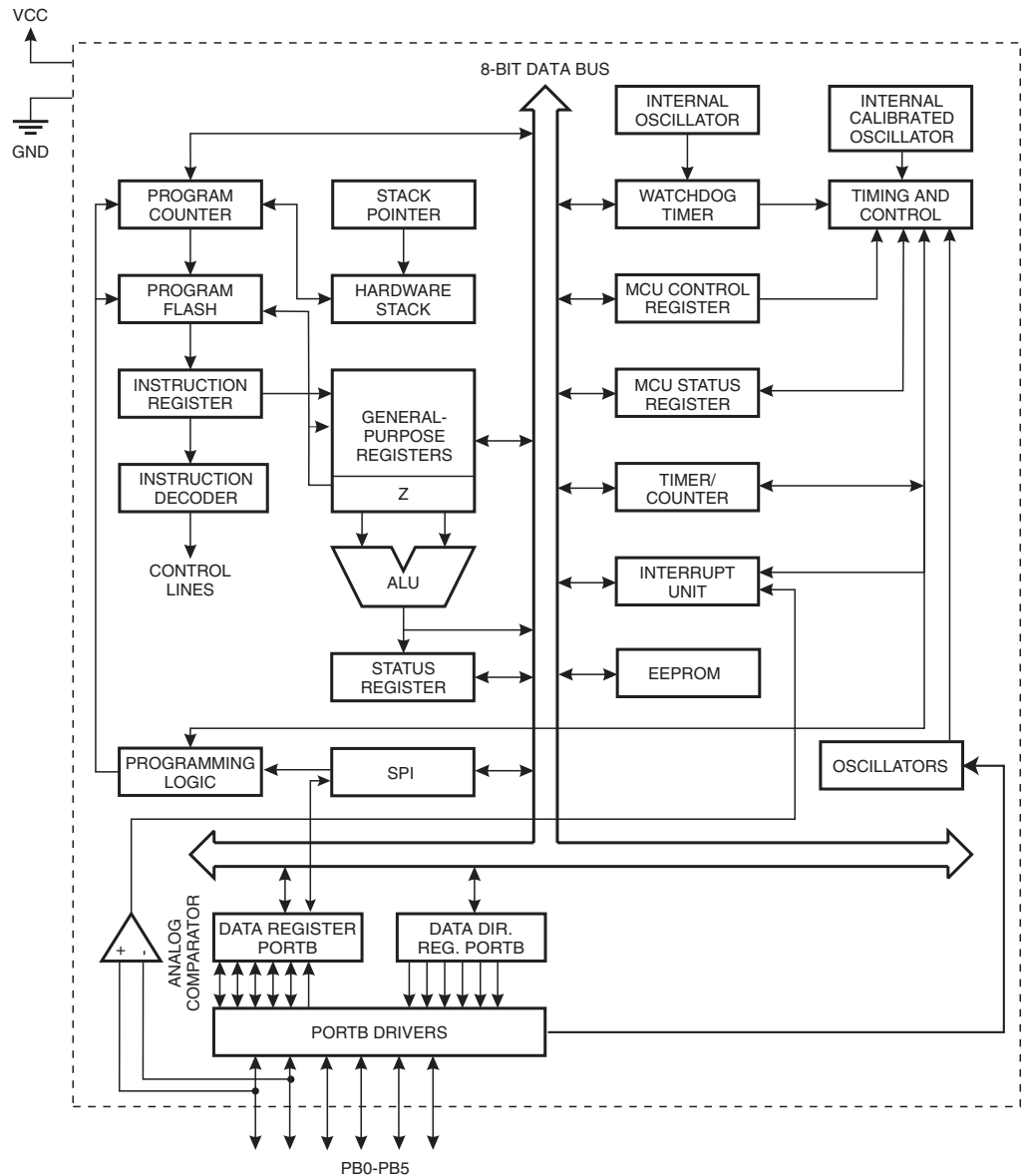

## Pin Descriptions

**VCC** Supply voltage pin.

**GND** Ground pin.

**Port B (PB5..PB0)** Port B is a 6-bit I/O port. PB4..0 are I/O pins that can provide internal pull-ups (selected for each bit). On ATtiny11, PB5 is input only. On ATtiny12, PB5 is input or open-drain output. The port pins are tri-stated when a reset condition becomes active, even if the clock is not running. The use of pins PB5..3 as input or I/O pins is limited, depending on reset and clock settings, as shown below.

**Table 2.** PB5..PB3 Functionality vs. Device Clocking Options

Device Clocking Option	PB5	PB4	PB3
External Reset Enabled	Used <sup>(1)</sup>	-( <sup>2)</sup>	-
External Reset Disabled	Input <sup>(3)</sup> /I/O <sup>(4)</sup>	-	-
External Crystal	-	Used	Used
External Low-frequency Crystal	-	Used	Used
External Ceramic Resonator	-	Used	Used
External RC Oscillator	-	I/O <sup>(5)</sup>	Used
External Clock	-	I/O	Used
Internal RC Oscillator	-	I/O	I/O

- Notes:
1. "Used" means the pin is used for reset or clock purposes.
  2. "-" means the pin function is unaffected by the option.
  3. Input means the pin is a port input pin.
  4. On ATtiny11, PB5 is input only. On ATtiny12, PB5 is input or open-drain output.
  5. I/O means the pin is a port input/output pin.

**XTAL1** Input to the inverting oscillator amplifier and input to the internal clock operating circuit.

**XTAL2** Output from the inverting oscillator amplifier.

**RESET** Reset input. An external reset is generated by a low level on the  $\overline{\text{RESET}}$  pin. Reset pulses longer than 50 ns will generate a reset, even if the clock is not running. Shorter pulses are not guaranteed to generate a reset.



## Register Summary ATtiny11

Address	Name	Bit 7	Bit 6	Bit 5	Bit 4	Bit 3	Bit 2	Bit 1	Bit 0	Page
\$3F	SREG	I	T	H	S	V	N	Z	C	page 9
\$3E	Reserved									
\$3D	Reserved									
\$3C	Reserved									
\$3B	GIMSK	-	INT0	PCIE	-	-	-	-	-	page 33
\$3A	GIFR	-	INTF0	PCIF	-	-	-	-	-	page 34
\$39	TIMSK	-	-	-	-	-	-	TOIE0	-	page 34
\$38	TIFR	-	-	-	-	-	-	TOV0	-	page 35
\$37	Reserved									
\$36	Reserved									
\$35	MCUCR	-	-	SE	SM	-	-	ISC01	ISC00	page 32
\$34	MCUSR	-	-	-	-	-	-	EXTRF	PORF	page 28
\$33	TCCR0	-	-	-	-	-	CS02	CS01	CS00	page 41
\$32	TCNT0	Timer/Counter0 (8 Bit)								page 41
\$31	Reserved									
\$30	Reserved									
...	Reserved									
\$22	Reserved									
\$21	WDTCR	-	-	-	WDTOE	WDE	WDP2	WDP1	WDP0	page 43
\$20	Reserved									
\$1F	Reserved									
\$1E	Reserved									
\$1D	Reserved									
\$1C	Reserved									
\$1B	Reserved									
\$1A	Reserved									
\$19	Reserved									
\$18	PORTB	-	-	-	PORTB4	PORTB3	PORTB2	PORTB1	PORTB0	page 37
\$17	DDRB	-	-	-	DDB4	DDB3	DDB2	DDB1	DDB0	page 37
\$16	PINB	-	-	PINB5	PINB4	PINB3	PINB2	PINB1	PINB0	page 37
\$15	Reserved									
...	Reserved									
\$0A	Reserved									
\$09	Reserved									
\$08	ACSR	ACD	-	ACO	ACI	ACIE	-	ACIS1	ACIS0	page 45
...	Reserved									
\$00	Reserved									

- Notes:
1. For compatibility with future devices, reserved bits should be written to zero if accessed. Reserved I/O memory addresses should never be written.
  2. Some of the status flags are cleared by writing a logical one to them. Note that the CBI and SBI instructions will operate on all bits in the I/O register, writing a one back into any flag read as set, thus clearing the flag. The CBI and SBI instructions work with registers \$00 to \$1F only.

## Register Summary ATtiny12

Address	Name	Bit 7	Bit 6	Bit 5	Bit 4	Bit 3	Bit 2	Bit 1	Bit 0	Page
\$3F	SREG	I	T	H	S	V	N	Z	C	page 9
\$3E	Reserved									
\$3D	Reserved									
\$3C	Reserved									
\$3B	GIMSK	-	INT0	PCIE	-	-	-	-	-	page 33
\$3A	GIFR	-	INTF0	PCIF	-	-	-	-	-	page 34
\$39	TIMSK	-	-	-	-	-	-	TOIE0	-	page 34
\$38	TIFR	-	-	-	-	-	-	TOV0	-	page 35
\$37	Reserved									
\$36	Reserved									
\$35	MCUCR	-	PUD	SE	SM	-	-	ISC01	ISC00	page 32
\$34	MCUSR	-	-	-	-	WDRF	BORF	EXTRF	PORF	page 29
\$33	TCCR0	-	-	-	-	-	CS02	CS01	CS00	page 41
\$32	TCNT0	Timer/Counter0 (8 Bit)								page 41
\$31	OSCCAL	Oscillator Calibration Register								page 12
\$30	Reserved									
...	Reserved									
\$22	Reserved									
\$21	WDTCR	-	-	-	WDTOE	WDE	WDP2	WDP1	WDP0	page 43
\$20	Reserved									
\$1F	Reserved									
\$1E	EEAR	-	-	EEPROM Address Register						page 18
\$1D	EEDR	EEPROM Data Register								page 18
\$1C	EECR	-	-	-	-	EERIE	EEMWE	EEWE	EERE	page 18
\$1B	Reserved									
\$1A	Reserved									
\$19	Reserved									
\$18	PORTB	-	-	-	PORTB4	PORTB3	PORTB2	PORTB1	PORTB0	page 37
\$17	DDRB	-	-	DDB5	DDB4	DDB3	DDB2	DDB1	DDB0	page 37
\$16	PINB	-	-	PINB5	PINB4	PINB3	PINB2	PINB1	PINB0	page 37
\$15	Reserved									
...	Reserved									
\$0A	Reserved									
\$09	Reserved									
\$08	ACSR	ACD	AINBG	ACO	ACI	ACIE	-	ACIS1	ACIS0	page 45
...	Reserved									
\$00	Reserved									

- Note:
- For compatibility with future devices, reserved bits should be written to zero if accessed. Reserved I/O memory addresses should never be written.
  - Some of the status flags are cleared by writing a logical one to them. Note that the CBI and SBI instructions will operate on all bits in the I/O register, writing a one back into any flag read as set, thus clearing the flag. The CBI and SBI instructions work with registers \$00 to \$1F only.

# Instruction Set Summary

Mnemonics	Operands	Description	Operation	Flags	#Clocks
<b>ARITHMETIC AND LOGIC INSTRUCTIONS</b>					
ADD	Rd, Rr	Add two Registers	$Rd \leftarrow Rd + Rr$	Z,C,N,V,H	1
ADC	Rd, Rr	Add with Carry two Registers	$Rd \leftarrow Rd + Rr + C$	Z,C,N,V,H	1
SUB	Rd, Rr	Subtract two Registers	$Rd \leftarrow Rd - Rr$	Z,C,N,V,H	1
SUBI	Rd, K	Subtract Constant from Register	$Rd \leftarrow Rd - K$	Z,C,N,V,H	1
SBC	Rd, Rr	Subtract with Carry two Registers	$Rd \leftarrow Rd - Rr - C$	Z,C,N,V,H	1
SBCI	Rd, K	Subtract with Carry Constant from Reg.	$Rd \leftarrow Rd - K - C$	Z,C,N,V,H	1
AND	Rd, Rr	Logical AND Registers	$Rd \leftarrow Rd \cdot Rr$	Z,N,V	1
ANDI	Rd, K	Logical AND Register and Constant	$Rd \leftarrow Rd \cdot K$	Z,N,V	1
OR	Rd, Rr	Logical OR Registers	$Rd \leftarrow Rd \vee Rr$	Z,N,V	1
ORI	Rd, K	Logical OR Register and Constant	$Rd \leftarrow Rd \vee K$	Z,N,V	1
EOR	Rd, Rr	Exclusive OR Registers	$Rd \leftarrow Rd \oplus Rr$	Z,N,V	1
COM	Rd	One's Complement	$Rd \leftarrow \text{SFF} - Rd$	Z,C,N,V	1
NEG	Rd	Two's Complement	$Rd \leftarrow \text{S00} - Rd$	Z,C,N,V,H	1
SBR	Rd,K	Set Bit(s) in Register	$Rd \leftarrow Rd \vee K$	Z,N,V	1
CBR	Rd,K	Clear Bit(s) in Register	$Rd \leftarrow Rd \cdot (\text{FFh} - K)$	Z,N,V	1
INC	Rd	Increment	$Rd \leftarrow Rd + 1$	Z,N,V	1
DEC	Rd	Decrement	$Rd \leftarrow Rd - 1$	Z,N,V	1
TST	Rd	Test for Zero or Minus	$Rd \leftarrow Rd \cdot Rd$	Z,N,V	1
CLR	Rd	Clear Register	$Rd \leftarrow Rd \oplus Rd$	Z,N,V	1
SER	Rd	Set Register	$Rd \leftarrow \text{SFF}$	None	1
<b>BRANCH INSTRUCTIONS</b>					
RJMP	k	Relative Jump	$PC \leftarrow PC + k + 1$	None	2
RCALL	k	Relative Subroutine Call	$PC \leftarrow PC + k + 1$	None	3
RET		Subroutine Return	$PC \leftarrow \text{STACK}$	None	4
RETI		Interrupt Return	$PC \leftarrow \text{STACK}$	I	4
CPSE	Rd,Rr	Compare, Skip if Equal	if (Rd = Rr) $PC \leftarrow PC + 2$ or 3	None	1/2
CP	Rd,Rr	Compare	$Rd - Rr$	Z, N, V, C, H	1
CPC	Rd,Rr	Compare with Carry	$Rd - Rr - C$	Z, N, V, C, H	1
CPI	Rd,K	Compare Register with Immediate	$Rd - K$	Z, N, V, C, H	1
SBRC	Rr, b	Skip if Bit in Register Cleared	if (Rr(b)=0) $PC \leftarrow PC + 2$ or 3	None	1/2
SBRS	Rr, b	Skip if Bit in Register is Set	if (Rr(b)=1) $PC \leftarrow PC + 2$ or 3	None	1/2
SBIC	P, b	Skip if Bit in I/O Register Cleared	if (P(b)=0) $PC \leftarrow PC + 2$ or 3	None	1/2
SBIS	P, b	Skip if Bit in I/O Register is Set	if (P(b)=1) $PC \leftarrow PC + 2$ or 3	None	1/2
BRBS	s, k	Branch if Status Flag Set	if (SREG(s) = 1) then $PC \leftarrow PC + k + 1$	None	1/2
BRBC	s, k	Branch if Status Flag Cleared	if (SREG(s) = 0) then $PC \leftarrow PC + k + 1$	None	1/2
BREQ	k	Branch if Equal	if (Z = 1) then $PC \leftarrow PC + k + 1$	None	1/2
BRNE	k	Branch if Not Equal	if (Z = 0) then $PC \leftarrow PC + k + 1$	None	1/2
BRCS	k	Branch if Carry Set	if (C = 1) then $PC \leftarrow PC + k + 1$	None	1/2
BRCC	k	Branch if Carry Cleared	if (C = 0) then $PC \leftarrow PC + k + 1$	None	1/2
BRSH	k	Branch if Same or Higher	if (C = 0) then $PC \leftarrow PC + k + 1$	None	1/2
BRLO	k	Branch if Lower	if (C = 1) then $PC \leftarrow PC + k + 1$	None	1/2
BRMI	k	Branch if Minus	if (N = 1) then $PC \leftarrow PC + k + 1$	None	1/2
BRPL	k	Branch if Plus	if (N = 0) then $PC \leftarrow PC + k + 1$	None	1/2
BRGE	k	Branch if Greater or Equal, Signed	if (N $\oplus$ V = 0) then $PC \leftarrow PC + k + 1$	None	1/2
BRLT	k	Branch if Less Than Zero, Signed	if (N $\oplus$ V = 1) then $PC \leftarrow PC + k + 1$	None	1/2
BRHS	k	Branch if Half Carry Flag Set	if (H = 1) then $PC \leftarrow PC + k + 1$	None	1/2
BRHC	k	Branch if Half Carry Flag Cleared	if (H = 0) then $PC \leftarrow PC + k + 1$	None	1/2
BRTS	k	Branch if T Flag Set	if (T = 1) then $PC \leftarrow PC + k + 1$	None	1/2
BRTC	k	Branch if T Flag Cleared	if (T = 0) then $PC \leftarrow PC + k + 1$	None	1/2
BRVS	k	Branch if Overflow Flag is Set	if (V = 1) then $PC \leftarrow PC + k + 1$	None	1/2
BRVC	k	Branch if Overflow Flag is Cleared	if (V = 0) then $PC \leftarrow PC + k + 1$	None	1/2
BRIE	k	Branch if Interrupt Enabled	if (I = 1) then $PC \leftarrow PC + k + 1$	None	1/2
BRID	k	Branch if Interrupt Disabled	if (I = 0) then $PC \leftarrow PC + k + 1$	None	1/2



## Instruction Set Summary (Continued)

Mnemonics	Operands	Description	Operation	Flags	#Clocks
<b>DATA TRANSFER INSTRUCTIONS</b>					
LD	Rd,Z	Load Register Indirect	$Rd \leftarrow (Z)$	None	2
ST	Z,Rr	Store Register Indirect	$(Z) \leftarrow Rr$	None	2
MOV	Rd, Rr	Move Between Registers	$Rd \leftarrow Rr$	None	1
LDI	Rd, K	Load Immediate	$Rd \leftarrow K$	None	1
IN	Rd, P	In Port	$Rd \leftarrow P$	None	1
OUT	P, Rr	Out Port	$P \leftarrow Rr$	None	1
LPM		Load Program Memory	$R0 \leftarrow (Z)$	None	3
<b>BIT AND BIT-TEST INSTRUCTIONS</b>					
SBI	P,b	Set Bit in I/O Register	$I/O(P,b) \leftarrow 1$	None	2
CBI	P,b	Clear Bit in I/O Register	$I/O(P,b) \leftarrow 0$	None	2
LSL	Rd	Logical Shift Left	$Rd(n+1) \leftarrow Rd(n), Rd(0) \leftarrow 0$	Z,C,N,V	1
LSR	Rd	Logical Shift Right	$Rd(n) \leftarrow Rd(n+1), Rd(7) \leftarrow 0$	Z,C,N,V	1
ROL	Rd	Rotate Left Through Carry	$Rd(0) \leftarrow C, Rd(n+1) \leftarrow Rd(n), C \leftarrow Rd(7)$	Z,C,N,V	1
ROR	Rd	Rotate Right Through Carry	$Rd(7) \leftarrow C, Rd(n) \leftarrow Rd(n+1), C \leftarrow Rd(0)$	Z,C,N,V	1
ASR	Rd	Arithmetic Shift Right	$Rd(n) \leftarrow Rd(n+1), n = 0..6$	Z,C,N,V	1
SWAP	Rd	Swap Nibbles	$Rd(3..0) \leftrightarrow Rd(7..4), Rd(7..4) \leftrightarrow Rd(3..0)$	None	1
BSET	s	Flag Set	$SREG(s) \leftarrow 1$	SREG(s)	1
BCLR	s	Flag Clear	$SREG(s) \leftarrow 0$	SREG(s)	1
BST	Rr, b	Bit Store from Register to T	$T \leftarrow Rr(b)$	T	1
BLD	Rd, b	Bit load from T to Register	$Rd(b) \leftarrow T$	None	1
SEC		Set Carry	$C \leftarrow 1$	C	1
CLC		Clear Carry	$C \leftarrow 0$	C	1
SEN		Set Negative Flag	$N \leftarrow 1$	N	1
CLN		Clear Negative Flag	$N \leftarrow 0$	N	1
SEZ		Set Zero Flag	$Z \leftarrow 1$	Z	1
CLZ		Clear Zero Flag	$Z \leftarrow 0$	Z	1
SEI		Global Interrupt Enable	$I \leftarrow 1$	I	1
CLI		Global Interrupt Disable	$I \leftarrow 0$	I	1
SES		Set Signed Test Flag	$S \leftarrow 1$	S	1
CLS		Clear Signed Test Flag	$S \leftarrow 0$	S	1
SEV		Set Twos Complement Overflow	$V \leftarrow 1$	V	1
CLV		Clear Twos Complement Overflow	$V \leftarrow 0$	V	1
SET		Set T in SREG	$T \leftarrow 1$	T	1
CLT		Clear T in SREG	$T \leftarrow 0$	T	1
SEH		Set Half Carry Flag in SREG	$H \leftarrow 1$	H	1
CLH		Clear Half Carry Flag in SREG	$H \leftarrow 0$	H	1
NOP		No Operation		None	1
SLEEP		Sleep	(see specific descr. for Sleep function)	None	1
WDR		Watch Dog Reset	(see specific descr. for WDR/timer)	None	1



## Ordering Information

### ATtiny11

Power Supply	Speed (MHz)	Ordering Code	Package	Operation Range
2.7 - 5.5V	2	ATtiny11L-2PC	8P3	Commercial (0°C to 70°C)
		ATtiny11L-2SC	8S2	
		ATtiny11L-2PI	8P3	Industrial (-40°C to 85°C)
ATtiny11L-2SI	8S2			
ATtiny11L-2SU <sup>(2)</sup>	8S2			
4.0 - 5.5V	6	ATtiny11-6PC	8P3	Commercial (0°C to 70°C)
		ATtiny11-6SC	8S2	
		ATtiny11-6PI	8P3	Industrial (-40°C to 85°C)
		ATtiny11-6PU <sup>(2)</sup>	8P3	
		ATtiny11-6SI	8S2	
ATtiny11-6SU <sup>(2)</sup>	8S2			

- Notes:
1. The speed grade refers to maximum clock rate when using an external crystal or external clock drive. The internal RC oscillator has the same nominal clock frequency for all speed grades.
  2. Pb-free packaging alternative, complies to the European Directive for Restriction of Hazardous Substances (RoHS directive). Also Halide free and fully Green.

Package Type	
<b>8P3</b>	8-lead, 0.300" Wide, Plastic Dual Inline Package (PDIP)
<b>8S2</b>	8-lead, 0.200" Wide, Plastic Gull-Wing Small Outline (EIAJ SOIC)

## ATtiny12

Power Supply	Speed (MHz)	Ordering Code	Package	Operation Range
1.8 - 5.5V	1.2	ATtiny12V-1PC	8P3	Commercial (0°C to 70°C)
		ATtiny12V-1SC	8S2	
		ATtiny12V-1PI	8P3	Industrial (-40°C to 85°C)
		ATtiny12V-1PU <sup>(2)</sup>	8P3	
ATtiny12V-1SI	8S2			
		ATtiny12V-1SU <sup>(2)</sup>	8S2	
2.7 - 5.5V	4	ATtiny12L-4PC	8P3	Commercial (0°C to 70°C)
		ATtiny12L-4SC	8S2	
		ATtiny12L-4PI	8P3	Industrial (-40°C to 85°C)
		ATtiny12L-4PU <sup>(2)</sup>	8P3	
ATtiny12L-4SI	8S2			
		ATtiny12L-4SU <sup>(2)</sup>	8S2	
4.0 - 5.5V	8	ATtiny12-8PC	8P3	Commercial (0°C to 70°C)
		ATtiny12-8SC	8S2	
		ATtiny12-8PI	8P3	Industrial (-40°C to 85°C)
		ATtiny12-8PU <sup>(2)</sup>	8P3	
ATtiny12-8SI	8S2			
		ATtiny12-8SU <sup>(2)</sup>	8S2	

- Notes:
1. The speed grade refers to maximum clock rate when using an external crystal or external clock drive. The internal RC oscillator has the same nominal clock frequency for all speed grades.
  2. Pb-free packaging alternative, complies to the European Directive for Restriction of Hazardous Substances (RoHS directive). Also Halide free and fully Green.

Package Type	
<b>8P3</b>	8-lead, 0.300" Wide, Plastic Dual Inline Package (PDIP)
<b>8S2</b>	8-lead, 0.200" Wide, Plastic Gull-Wing Small Outline (EIAJ SOIC)

# Packaging Information

8P3

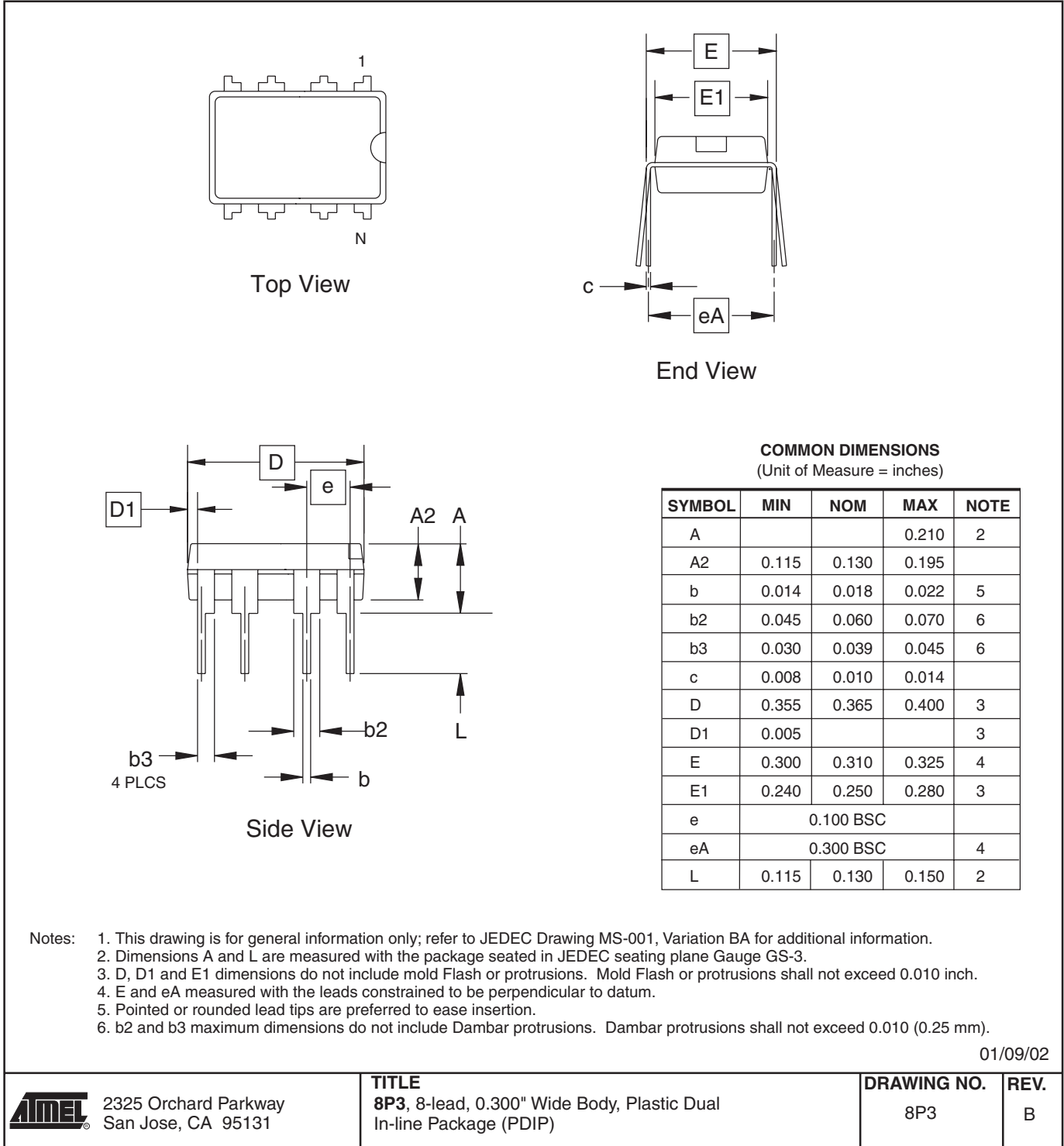

8S2

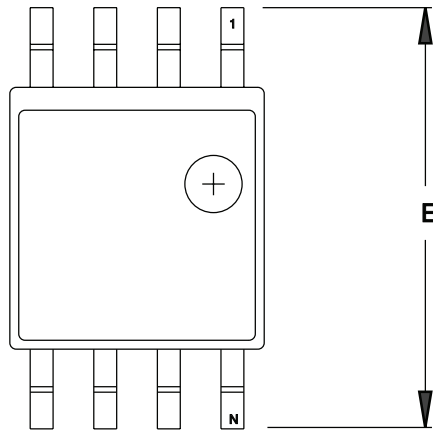

**TOP VIEW**

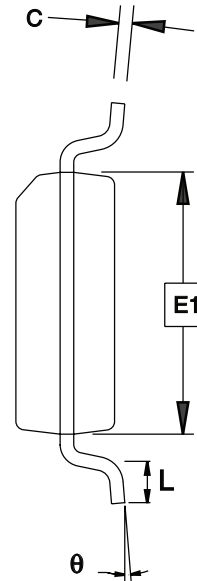

**END VIEW**

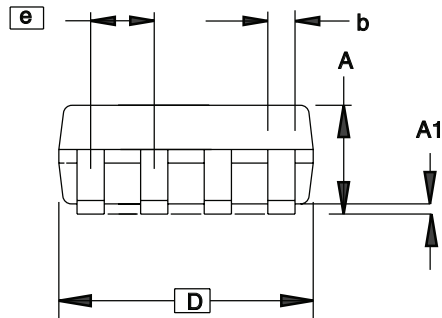

**SIDE VIEW**

**COMMON DIMENSIONS**  
(Unit of Measure = mm)

SYMBOL	MIN	NOM	MAX	NOTE
A	1.70		2.16	
A1	0.05		0.25	
b	0.35		0.48	5
C	0.15		0.35	5
D	5.13		5.35	
E1	5.18		5.40	2, 3
E	7.70		8.26	
L	0.51		0.85	
$\theta$	0°		8°	
e	1.27 BSC			4

- Notes: 1. This drawing is for general information only; refer to EIAJ Drawing EDR-7320 for additional information.  
 2. Mismatch of the upper and lower dies and resin burrs are not included.  
 3. It is recommended that upper and lower cavities be equal. If they are different, the larger dimension shall be regarded.  
 4. Determines the true geometric position.  
 5. Values b,C apply to plated terminal. The standard thickness of the plating layer shall measure between 0.007 to .021 mm.

4/7/06



2325 Orchard Parkway  
San Jose, CA 95131

**TITLE**  
8S2, 8-lead, 0.209" Body, Plastic Small  
Outline Package (EIAJ)

**DRAWING NO.**  
8S2

**REV.**  
D



## Datasheet Revision History

Please note that the page numbers listed in this section are referring to this document. The revision numbers are referring to the document revision.

### Rev. 1006F-06/07

1. “Not recommended for new design”

### Rev. 1006E-07/06

1. Updated chapter layout.
2. Updated Power-down in “Sleep Modes for the ATtiny11” on page 20.
3. Updated Power-down in “Sleep Modes for the ATtiny12” on page 20.
4. Updated Table 16 on page 36.
5. Updated “Calibration Byte in ATtiny12” on page 49.
6. Updated “Ordering Information” on page 10.
7. Updated “Packaging Information” on page 12.

### Rev. 1006D-07/03

1. Updated  $V_{BOT}$  values in Table 9 on page 24.

### Rev. 1006C-09/01

1. N/A



## Headquarters

---

**Atmel Corporation**  
2325 Orchard Parkway  
San Jose, CA 95131  
USA  
Tel: 1(408) 441-0311  
Fax: 1(408) 487-2600

## International

---

**Atmel Asia**  
Room 1219  
Chinachem Golden Plaza  
77 Mody Road Tsimshatsui  
East Kowloon  
Hong Kong  
Tel: (852) 2721-9778  
Fax: (852) 2722-1369

**Atmel Europe**  
Le Krebs  
8, Rue Jean-Pierre Timbaud  
BP 309  
78054 Saint-Quentin-en-  
Yvelines Cedex  
France  
Tel: (33) 1-30-60-70-00  
Fax: (33) 1-30-60-71-11

**Atmel Japan**  
9F, Tonetsu Shinkawa Bldg.  
1-24-8 Shinkawa  
Chuo-ku, Tokyo 104-0033  
Japan  
Tel: (81) 3-3523-3551  
Fax: (81) 3-3523-7581

## Product Contact

---

**Web Site**  
[www.atmel.com](http://www.atmel.com)

**Technical Support**  
[avr@atmel.com](mailto:avr@atmel.com)

**Sales Contact**  
[www.atmel.com/contacts](http://www.atmel.com/contacts)

**Literature Requests**  
[www.atmel.com/literature](http://www.atmel.com/literature)

---

**Disclaimer:** The information in this document is provided in connection with Atmel products. No license, express or implied, by estoppel or otherwise, to any intellectual property right is granted by this document or in connection with the sale of Atmel products. **EXCEPT AS SET FORTH IN ATMEL'S TERMS AND CONDITIONS OF SALE LOCATED ON ATMEL'S WEB SITE, ATMEL ASSUMES NO LIABILITY WHATSOEVER AND DISCLAIMS ANY EXPRESS, IMPLIED OR STATUTORY WARRANTY RELATING TO ITS PRODUCTS INCLUDING, BUT NOT LIMITED TO, THE IMPLIED WARRANTY OF MERCHANTABILITY, FITNESS FOR A PARTICULAR PURPOSE, OR NON-INFRINGEMENT. IN NO EVENT SHALL ATMEL BE LIABLE FOR ANY DIRECT, INDIRECT, CONSEQUENTIAL, PUNITIVE, SPECIAL OR INCIDENTAL DAMAGES (INCLUDING, WITHOUT LIMITATION, DAMAGES FOR LOSS OF PROFITS, BUSINESS INTERRUPTION, OR LOSS OF INFORMATION) ARISING OUT OF THE USE OR INABILITY TO USE THIS DOCUMENT, EVEN IF ATMEL HAS BEEN ADVISED OF THE POSSIBILITY OF SUCH DAMAGES.** Atmel makes no representations or warranties with respect to the accuracy or completeness of the contents of this document and reserves the right to make changes to specifications and product descriptions at any time without notice. Atmel does not make any commitment to update the information contained herein. Unless specifically provided otherwise, Atmel products are not suitable for, and shall not be used in, automotive applications. Atmel's products are not intended, authorized, or warranted for use as components in applications intended to support or sustain life.

© 2007 Atmel Corporation. All rights reserved. Atmel®, logo and combinations thereof, and others are registered trademarks or trademarks of Atmel Corporation or its subsidiaries. Other terms and product names may be trademarks of others.

# AMEYA360

## Components Supply Platform

Authorized Distribution Brand :



Website :

Welcome to visit [www.ameya360.com](http://www.ameya360.com)

Contact Us :

➤ Address :

401 Building No.5, JiuGe Business Center, Lane 2301, Yishan Rd  
Minhang District, Shanghai , China

➤ Sales :

Direct +86 (21) 6401-6692

Email [amall@ameya360.com](mailto:amall@ameya360.com)

QQ 800077892

Skype [ameyasales1](#) [ameyasales2](#)

➤ Customer Service :

Email [service@ameya360.com](mailto:service@ameya360.com)

➤ Partnership :

Tel +86 (21) 64016692-8333

Email [mkt@ameya360.com](mailto:mkt@ameya360.com)