

# LM49450 Boomer™ I<sup>2</sup>S Input, 2.5W/Channel, Low EMI, Stereo, Class D Audio Sub-System with Ground Referenced Headphone Amplifier, 3D Enhancement, and Headphone Sense

Check for Samples: [LM49450](#)

## FEATURES

- 24-Bit Stereo DAC
- Stereo Filterless Class D Operation
- Selectable Spread Spectrum Mode Reduces EMI
- Ground Referenced Headphone Amplifiers with 100dB SNR
- I<sup>2</sup>S Compatible Audio Interface
- Audio Sample Rates up to 192kHz
- TI's 3D Enhancement
- 32-Step Digital Volume Control
- I<sup>2</sup>C-Compatible Control Interface
- Headphone Sense Input
- Stereo Analog Line Inputs
- Output Short Circuit Protection
- Thermal Overload Protection
- Minimum External Components
- Click and Pop Suppression
- Micro-Power Shutdown
- Available in Space-Saving 32-Pin WQFN Package

## APPLICATIONS

- Portable Media Players
- Portable Navigation Devices
- Multi-Media Monitors
- Laptops
- Portable Gaming Devices
- Mobile Handsets

## KEY SPECIFICATIONS

- SNR at Headphone Output: 102dBA (typ)
- Speaker Amplifier Efficiency at 3.6V, 650mW/Channel into 8Ω: 87% (typ)
- Speaker Amplifier Efficiency at 5V, 1.1W/Channel into 8Ω: 80% (typ)
- Quiescent Power Supply Current Line Inputs:
  - Speaker Mode at LSVDD = 3.6V: 7.5mA (typ)
  - Headphone Mode at HPVDD = 2.5V: 5.3mA (typ)
- Output Power/Channel Speaker at LSV<sub>DD</sub> = 5V:
  - R<sub>L</sub> = 4Ω, THD+N ≤ 10%: 2.5W (typ)
  - R<sub>L</sub> = 8Ω, THD+N ≤ 1%: 1.25W (typ)
- Headphone at HPV<sub>DD</sub> = 2.5V:
  - R<sub>L</sub> = 16Ω, THD+N ≤ 1%: 34mW (typ)
  - R<sub>L</sub> = 32Ω, THD+N ≤ 1%: 36mW (typ)
- PSRR at 1kHz
  - Speaker Mode: 67dB (typ)
  - Headphone Mode: 77dB (typ)
- Shutdown current: 0.02μA (typ)

## DESCRIPTION

The LM49450 is a fully integrated audio subsystem designed for portable media player applications. The LM49450 combines a 24-bit I<sup>2</sup>S digital-to-analog converter (DAC), 2.5W/channel stereo Class D speaker drivers, 36mW stereo ground referenced headphone drivers, volume control, and TI's unique 3D sound enhancement into a single device.



Please be aware that an important notice concerning availability, standard warranty, and use in critical applications of Texas Instruments semiconductor products and disclaimers thereto appears at the end of this data sheet.

is a trademark of ~ Texas Instruments.

All other trademarks are the property of their respective owners.

## DESCRIPTION (CONTINUED)

The filterless Class D amplifiers deliver 1.25W/channel into an 8Ω load with <1% THD+N with a 5V supply. The LM49450 offers two logic selectable modulation schemes, fixed frequency mode, and an EMI reducing spread spectrum mode. The 36mW/channel headphone drivers feature TI's ground referenced architecture that creates a ground-referenced output from a single supply, eliminating the need for bulky and expensive DC-blocking capacitors, saving space and minimizing system cost. A headphone sense input (HPS) automatically detects the presence of a headphone, and configures the device accordingly.

The LM49450 stereo, 24-bit DAC supports a wide range of sample rates (including 192kHz, 96kHz, 48kHz, and 44.1kHz). The digital audio signal path features better than 100dB SNR, and low 0.05% THD+N when measured at the headphone outputs. The flexible 3-wire I<sup>2</sup>S interface supports left or right justified audio data.

The LM49450 features separate 32-step volume control for the headphones and speaker outputs. 3D enhancement, mode selection, shutdown control, and volume are controlled through an I<sup>2</sup>C compatible interface.

Output short circuit and thermal overload protection prevent the device from being damaged during fault conditions. Superior click and pop suppression eliminates audible transients on power-up/down and during shutdown. The LM49450 is available in a space saving 32-pin WQFN package.

## Typical Application

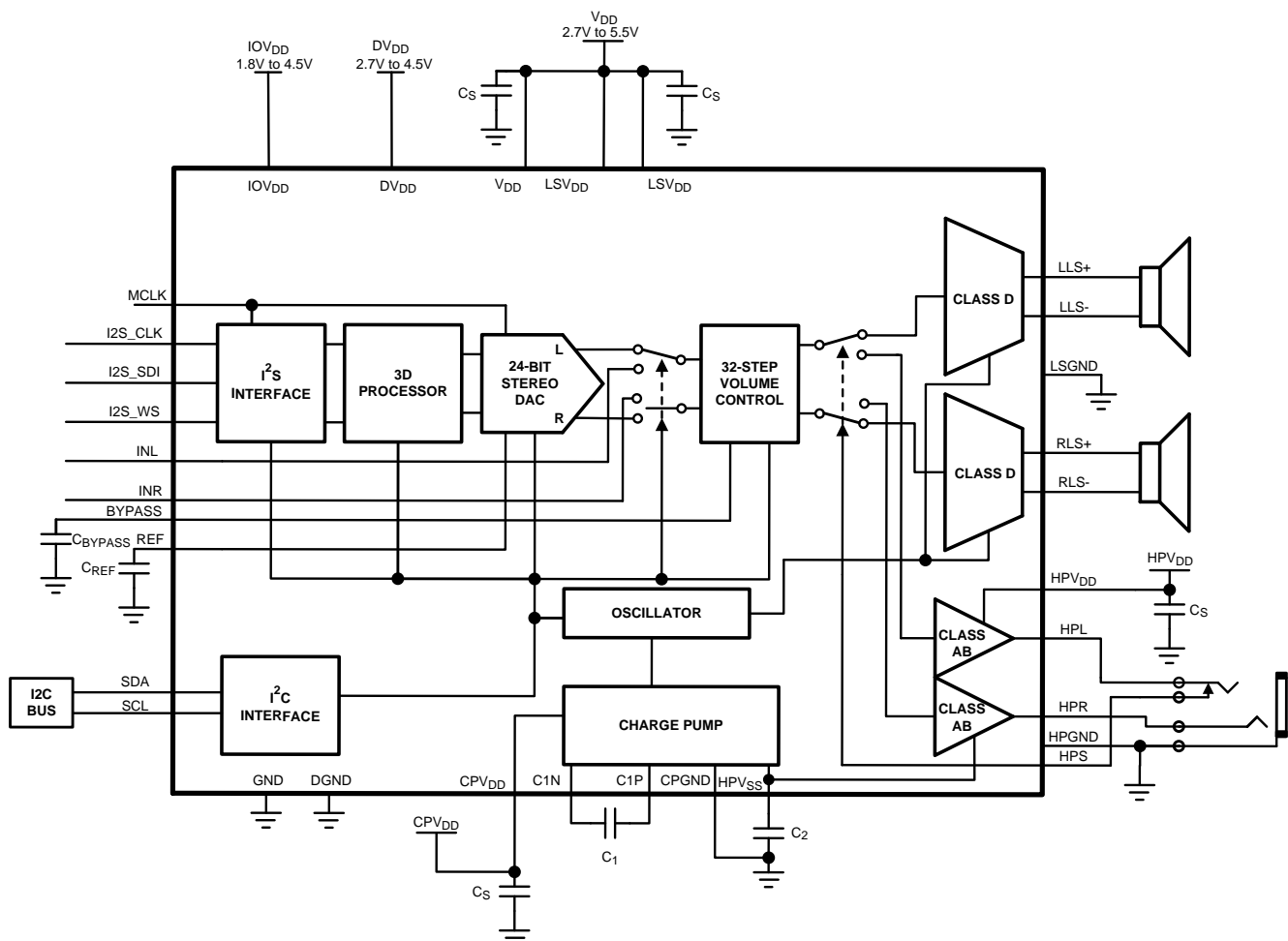
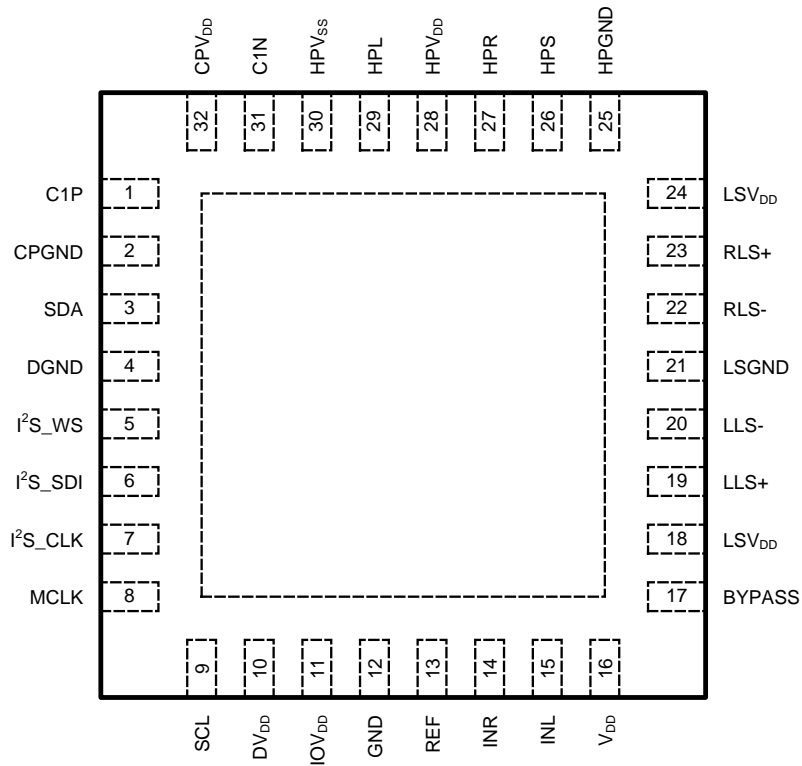

Figure 1. Typical Audio Amplifier Application Circuit

Connection Diagram



**Figure 2. RTV Package Top View  
5mm x 5mm x 0.8mm  
Package Number RTV0032A**



These devices have limited built-in ESD protection. The leads should be shorted together or the device placed in conductive foam during storage or handling to prevent electrostatic damage to the MOS gates.

**Absolute Maximum Ratings**<sup>(1)(2)(3)</sup>

Supply Voltage <sup>(1)</sup>	6.0V
Storage Temperature	–65°C to +150°C
Input Voltage	–0.3V to V <sub>DD</sub> +0.3V
Power Dissipation <sup>(4)</sup>	Internally Limited
ESD Susceptibility <sup>(5)</sup>	2000V
ESD Susceptibility <sup>(6)</sup>	200V
Junction Temperature (T <sub>JMAX</sub> )	150°C
Thermal Resistance	
θ <sub>JC</sub>	2.4°C/W
θ <sub>JA</sub>	28.4°C/W

- (1) “*Absolute Maximum Ratings*” indicate limits beyond which damage to the device may occur, including inoperability and degradation of device reliability and/or performance. Functional operation of the device and/or non-degradation at the *Absolute Maximum Ratings* or other conditions beyond those indicated in the *Recommended Operating Conditions* is not implied. The *Recommended Operating Conditions* indicate conditions at which the device is functional and the device should not be operated beyond such conditions. All voltages are measured with respect to the ground pin, unless otherwise specified
- (2) The *Electrical Characteristics* tables list ensured specifications under the listed *Recommended Operating Conditions* except as otherwise modified or specified by the *Electrical Characteristics Conditions* and/or Notes. Typical specifications are estimations only and are not ensured.
- (3) If Military/Aerospace specified devices are required, please contact the Texas Instruments Sales Office/ Distributors for availability and specifications.
- (4) The maximum power dissipation must be derated at elevated temperatures and is dictated by T<sub>JMAX</sub>, θ<sub>JA</sub>, and the ambient temperature, T<sub>A</sub>. The maximum allowable power dissipation is P<sub>DMAX</sub> = (T<sub>JMAX</sub> – T<sub>A</sub>) / θ<sub>JA</sub> or the number given in *Absolute Maximum Ratings*, whichever is lower.
- (5) Human body model, applicable std. JESD22-A114C.
- (6) Machine model, applicable std. JESD22-A115-A.

**Operating Ratings**<sup>(1)(2)</sup>

Temperature Range	
T <sub>MIN</sub> ≤ T <sub>A</sub> ≤ T <sub>MAX</sub>	–40°C ≤ T <sub>A</sub> ≤ +85°C
Supply Voltage (V <sub>DD</sub> , LSV <sub>DD</sub> )	2.7V ≤ V <sub>DD</sub> ≤ 5.5V
Headphone Supply Voltage (CPV <sub>DD</sub> , HPV <sub>DD</sub> )	1.8V ≤ V <sub>DD</sub> ≤ 2.7V
Digital Core Supply Voltage (DV <sub>DD</sub> )	2.7V ≤ DV <sub>DD</sub> ≤ 4.5V
Digital IO Supply Voltage (IOV <sub>DD</sub> )	1.8V ≤ IOV <sub>DD</sub> ≤ 4.5V

- (1) “*Absolute Maximum Ratings*” indicate limits beyond which damage to the device may occur, including inoperability and degradation of device reliability and/or performance. Functional operation of the device and/or non-degradation at the *Absolute Maximum Ratings* or other conditions beyond those indicated in the *Recommended Operating Conditions* is not implied. The *Recommended Operating Conditions* indicate conditions at which the device is functional and the device should not be operated beyond such conditions. All voltages are measured with respect to the ground pin, unless otherwise specified
- (2) The *Electrical Characteristics* tables list ensured specifications under the listed *Recommended Operating Conditions* except as otherwise modified or specified by the *Electrical Characteristics Conditions* and/or Notes. Typical specifications are estimations only and are not ensured.

**Electrical Characteristics  $V_{DD} = LSV_{DD} = 3.6V$ ,  $HPV_{DD} = CPV_{DD} = 2.5V^{(1)(2)}$** 

The following specifications apply for Headphone:  $A_V = 0dB$ ,  $R_{L(LS)} = 8\Omega$ ,  $R_{L(HP)} = 32\Omega$ ,  $f = 1kHz$ ,  $C_1 = C_2 = 2.2\mu F$ , unless otherwise specified. Limits apply for  $T_A = 25^\circ C$ .

Symbol	Parameter	Conditions	LM49450		Units (Limits)
			Typical <sup>(3)</sup>	Limit <sup>(4)</sup>	
$I_{DD}$	Digital Core Supply Current	$DV_{DD} = 2.7V$ , $f_S = 48kHz$ , $f_{MCLK} = 12.28MHz$	9	11.2	mA (max)
$I_{SD}$	Shutdown Supply Current	Digital Current Analog Current	0.03 0.02	1 1	$\mu A$ (max) $\mu A$ (max)
<b>SPEAKER AMPLIFIERS (Headphone Amplifiers Disabled, HPS = 0)</b>					
$I_{DDLs}$	Analog Supply Current	$f_S = 48kHz$ , DAC Active, No Load Line Inputs Active, No Load	9.8 7	13 10	mA (max) mA (max)
$V_{OS}$	Output Offset Voltage	DAC Active Line Inputs Active	8 8	45	mV (max) mV (max)
$P_{OUT}$	Output Power	$R_L = 4\Omega$ , $f = 1kHz$ THD+N = 1% THD+N = 10%	1 1.2		W W
		$R_L = 8\Omega$ , $f = 1kHz$ THD+N = 1% THD+N = 10%	625 725	525	mW (min) W
THD+N	Total Harmonic Distortion	$P_O = 300mW$ , $f = 1kHz$ , $R_L = 8\Omega$			
		DAC Active	0.06		%
		Line Inputs Active	0.07		%
PSRR	Power Supply Rejection Ratio	$V_{RIPPLE} = 200mV_{P-P}$ , $f = 1kHz$			
		DAC Active, Internal Reference	59	45	dB (min)
		DAC Active, External Reference	62		dB
		Line Inputs Active	67		dB
$\eta$	Efficiency	$P_O = 650$ , $f = 1kHz$ $R_L = 8\Omega$	87		%
Xtalk	Crosstalk	$P_O = 500mW$ , $f = 1kHz$ , $R_L = 8\Omega$			
		DAC Active, Line Inputs Active	81 77		dB dB
		$P_O = 500mW$ , $f = 10kHz$ , $R_L = 8\Omega$			
		DAC Active, Line Inputs Active	60 60		dB dB
SNR	Signal to Noise Ratio	$P_O = 500mW$ , $f = 1kHz$ , A-weighted			
		DAC Active, Internal Reference	89		dB
		DAC Active, External Reference	92		dB
		Line Inputs Active	90		dB
$A_V$	Digitally Controlled Gain Level	Maximum Gain Setting, Line Inputs Active	23.6	22.5 24.1	dB (min) dB (max)
		Minimum Gain Setting, Line Inputs Active	-48	-49 -46	dB (min) dB (max)
Mute	Mute Attenuation	Line Inputs Active	-91		dB
$\Delta A_{CH-CH}$	Channel-to-Channel Gain Matching		0.3		dB

- (1) The *Electrical Characteristics* tables list ensured specifications under the listed *Recommended Operating Conditions* except as otherwise modified or specified by the *Electrical Characteristics Conditions* and/or Notes. Typical specifications are estimations only and are not ensured.
- (2)  $R_L$  is a resistive load in series with two inductors to simulate an actual speaker load. For  $R_L = 8\Omega$ , the load is  $15\mu H + 8\Omega + 15\mu H$ . For  $R_L = 4\Omega$ , the load is  $15\mu H + 4\Omega + 15\mu H$ .
- (3) Typical values represent most likely parametric norms at  $T_A = +25^\circ C$ , and at the Recommended Operation Conditions at the time of product characterization and are not ensured.
- (4) Datasheet min/max specification limits are specified by test or statistical analysis.

**Electrical Characteristics  $V_{DD} = LSV_{DD} = 3.6V$ ,  $HPV_{DD} = CPV_{DD} = 2.5V^{(1)(2)}$  (continued)**

The following specifications apply for Headphone:  $A_V = 0dB$ ,  $R_{L(LS)} = 8\Omega$ ,  $R_{L(HP)} = 32\Omega$ ,  $f = 1kHz$ ,  $C_1 = C_2 = 2.2\mu F$ , unless otherwise specified. Limits apply for  $T_A = 25^\circ C$ .

Symbol	Parameter	Conditions	LM49450		Units (Limits)
			Typical <sup>(3)</sup>	Limit <sup>(4)</sup>	
$\epsilon_{OS}$	Output Noise	Input Referred, A-weighted			
		DAC Active, Internal Reference	43.5		$\mu V$
		DAC Active, External Reference	45.4		$\mu V$
		Line Inputs Active	40		$\mu V$
$t_{ON}$	Turn-On Time		27		ms
$t_{OFF}$	Turn-Off Time		1		ms
<b>HEADPHONE AMPLIFIERS (Speaker Amplifiers Disabled, HPS = 1)</b>					
$I_{DDHP}$	Analog Supply Current	$f_S = 48kHz$ , DAC active	7.2	8.25	mA (max)
		Line Inputs Active	5.3	6.5	mA (max)
$V_{OS}$	Output Offset Voltage	DAC active, $A_V = -6dB$	7	30	mV
		Line Inputs Active, $A_V = -6dB$	5		mV (max)
$P_O$	Output Power	$R_L = 16\Omega$ , $f = 1kHz$			
		THD+N = 1%, Single Channel	66		mW
		THD+N = 1%, Two Channels in Phase	34		mW
		$R_L = 32\Omega$ , $f = 1kHz$			
		THD+N = 1%, Single Channel	49	42	mW (min)
		THD+N = 1%, Two Channels in Phase	36	27	mW (min)
THD+N	Total Harmonic Distortion	$f = 1kHz$ , DAC Active			
		$R_L = 16\Omega$ , $P_O = 5mW$	0.05		%
		$R_L = 32\Omega$ , $P_O = 5mW$	0.03		%
PSRR	Power Supply Rejection Ratio	$V_{RIPPLE} = 200mV_{P-P}$ , $f = 1kHz$			
		DAC Active, Internal Reference	71.2	56	dB (min)
		DAC Active, External Reference	71.3		dB
		Line Inputs Active	76.9		dB
Xtalk	Crosstalk	$P_O = 5mW$ , $f = 1kHz$ , $R_L = 32\Omega$			
		DAC Active, Line Inputs Active	82 79		dB dB
		$P_O = 5mW$ , $f = 10kHz$ , $R_L = 32\Omega$			
		DAC Active, Line Inputs Active	78 76		dB dB
SNR	Signal to Noise Ratio	$P_O = 5mW$ , $f = 1kHz$ , A-weighted			
		DAC Active, Internal Reference	99		dB
		DAC Active, External Reference	102		dB
		Line Inputs Active	98		dB
$A_V$	Digitally Controlled Gain Level	Maximum Gain Setting, Line Inputs Active	17.8	17.0 18.5	dB (min) dB (max)
		Minimum Gain Setting, Line Inputs Active	-53.8	-56 -52	dB (min) dB (max)
Mute	Mute Attenuation	Line Inputs Active	-102		dB
$\Delta A_{CH-CH}$	Channel-to-Channel Gain Matching		0.3		dB
$\epsilon_{OS}$	Output Noise	Input Referred, A-weighted			
		DAC Active, Internal Reference	10		$\mu V$
		DAC Active, External Reference	10		$\mu V$
		Line Inputs Active	10		$\mu V$

**Electrical Characteristics  $V_{DD} = LSV_{DD} = 3.6V$ ,  $HPV_{DD} = CPV_{DD} = 2.5V^{(1)(2)}$  (continued)**

The following specifications apply for Headphone:  $A_V = 0dB$ ,  $R_{L(LS)} = 8\Omega$ ,  $R_{L(HP)} = 32\Omega$ ,  $f = 1kHz$ ,  $C_1 = C_2 = 2.2\mu F$ , unless otherwise specified. Limits apply for  $T_A = 25^\circ C$ .

Symbol	Parameter	Conditions	LM49450		Units (Limits)
			Typical <sup>(3)</sup>	Limit <sup>(4)</sup>	
$V_{OUT\_FS}$	Full-Scale Headphone Amplifier Output Voltage	$R_L = \text{No Load}$	942	850	mV <sub>RMS</sub> (min)
$t_{ON}$	Turn-On Time		27		ms
$t_{OFF}$	Turn-Off Time		1		ms
<b>HEADPHONE SENSE INPUT (HPS)</b>					
$V_{IH}$	Input High Voltage		1		V
$V_{IL}$	Input Low Voltage		0.6		V
<b>DIGITAL INTERFACE</b>					
$V_{IH}$	Input High Voltage			2.8	V (min)
$V_{IL}$	Input Low Voltage			0.8	V (max)
$V_{OH}$	Output High Voltage			2	V (min)
$V_{OL}$	Output Low Voltage			1	V (max)

**Electrical Characteristics  $V_{DD} = LSV_{DD} = 5.0V^{(1)(2)}$** 

The following specifications apply for Headphone:  $A_V = 0dB$ ,  $R_{L(LS)} = 8\Omega$ ,  $R_{L(HP)} = 32\Omega$ ,  $f = 1kHz$ , unless otherwise specified. Limits apply for  $T_A = 25^\circ C$ .

Symbol	Parameter	Conditions	LM49450		Units (Limits)
			Typical <sup>(3)</sup>	Limit <sup>(4)</sup>	
<b>SPEAKER AMPLIFIERS (Headphone Amplifiers Disabled, HPS = 0)</b>					
$I_{DDLS}$	Analog Supply Current	$f_S = 48kHz$ , DAC Active Line Inputs Active	14 10.4	18 16	mA (max) mA (max)
$V_{OS}$	Output Offset Voltage	DAC Voltage $A_V = 0dB$ , Line Inputs Active	15 12	50 48	mV (max) mV (max)
$P_{OUT}$	Output Power	$R_L = 4\Omega$ , $f = 1kHz$ THD+N = 1% THD+N = 10%	1.9 2.5		W W
		$R_L = 8\Omega$ , $f = 1kHz$ THD+N = 1% THD+N = 10%	1.25 1.54		mW (min) W
THD+N	Total Harmonic Distortion	$P_O = 635mW$ , $f = 1kHz$ , $R_L = 8\Omega$			
		DAC Active	0.06		%
		Line Inputs Active	0.04		%
PSRR	Power Supply Rejection Ratio	$V_{RIPPLE} = 200mV_{P-P}$ , $f = 1kHz$			
		DAC Active, Internal Reference	60		dB
		DAC Active, External Reference	60		dB
		Line Inputs Active	70		dB
$\eta$	Efficiency	$P_O = TBDmW$ , $f = 1kHz$ $R_L = 8\Omega$	80		%

- (1) The *Electrical Characteristics* tables list ensured specifications under the listed *Recommended Operating Conditions* except as otherwise modified or specified by the *Electrical Characteristics Conditions* and/or Notes. Typical specifications are estimations only and are not ensured.
- (2)  $R_L$  is a resistive load in series with two inductors to simulate an actual speaker load. For  $R_L = 8\Omega$ , the load is  $15\mu H + 8\Omega + 15\mu H$ . For  $R_L = 4\Omega$ , the load is  $15\mu H + 4\Omega + 15\mu H$ .
- (3) Typical values represent most likely parametric norms at  $T_A = +25^\circ C$ , and at the Recommended Operation Conditions at the time of product characterization and are not ensured.
- (4) Datasheet min/max specification limits are specified by test or statistical analysis.

**Electrical Characteristics  $V_{DD} = LSV_{DD} = 5.0V^{(1)(2)}$  (continued)**

The following specifications apply for Headphone:  $A_V = 0dB$ ,  $R_{L(LS)} = 8\Omega$ ,  $R_{L(HP)} = 32\Omega$ ,  $f = 1kHz$ , unless otherwise specified. Limits apply for  $T_A = 25^\circ C$ .

Symbol	Parameter	Conditions	LM49450		Units (Limits)
			Typical <sup>(3)</sup>	Limit <sup>(4)</sup>	
Xtalk	Crosstalk	$P_O = 500mW$ , $f = 1kHz$ , $R_L = 8\Omega$			
		DAC Active, Line Inputs Active	74 79		dB dB
		$P_O = 500mW$ , $f = 10kHz$ , $R_L = 8\Omega$			
		DAC Active, Line Inputs Active	60 60		dB dB
SNR	Signal to Noise Ratio	$P_O = 500mW$ , $f = 1kHz$ , A-weighted			
		DAC Active, Internal Reference	88		dB
		DAC Active, External Reference	89		dB
		Line Inputs Active	98		dB
$A_V$	Digitally Controlled Gain Level	Maximum Gain Setting, Line Inputs Active	24.2	22.5 24.2	dB (min) dB (max)
		Minimum Gain Setting, Line Inputs Active	-48	-49 -46	dB (min) dB (max)
Mute	Mute Attenuation	Line Inputs Active	-92		dB
$\Delta A_{CH-CH}$	Channel-to-Channel Gain Matching		0.3		dB
$\epsilon_{OS}$	Output Noise	Input Referred, A-weighted			
		DAC Active, Internal Reference	60		$\mu V$
		DAC Active, External Reference	85		$\mu V$
		Line Inputs Active	40		$\mu V$
$t_{ON}$	Turn-On Time		27		ms
$t_{OFF}$	Turn-Off Time		1		ms

**Timing Characteristics<sup>(1)(2)</sup>**

The following specifications apply for Headphone:  $A_V = 0dB$ ,  $R_{L(LS)} = 8\Omega$ ,  $R_{L(HP)} = 32\Omega$ ,  $f = 1kHz$ , unless otherwise specified. Limits apply for  $T_A = 25^\circ C$ .

Symbol	Parameter	Conditions	LM49450		Units (Limits)
			Typical <sup>(3)</sup>	Limit <sup>(4)</sup>	
<b>AUDIO INTERFACE TIMING</b>					
$t_{MCLKL}$	MCLK Pulse Width Low			16	ns (min)
$t_{MCLKH}$	MCLK Pulse Width High			16	ns (min)
$t_{MCLKY}$	MCLK Period			32	ns (min)
$t_{BCLKR}$	BCLK Rise Time			3	ns (max)
$t_{BCLKCF}$	BCLK Fall Time			3	ns (max)
$t_{BCLKDS}$	BCLK Duty Cycle		50		%
$t_{DL}$	LRC Propagation Delay from BCLK falling edge			10	ns (max)
$t_{DST}$	DATA Setup Time to BCLK Rising Edge			10	ns (min)

- (1) The *Electrical Characteristics* tables list ensured specifications under the listed *Recommended Operating Conditions* except as otherwise modified or specified by the *Electrical Characteristics Conditions* and/or Notes. Typical specifications are estimations only and are not ensured.
- (2)  $R_L$  is a resistive load in series with two inductors to simulate an actual speaker load. For  $R_L = 8\Omega$ , the load is  $15\mu H + 8\Omega + 15\mu H$ . For  $R_L = 4\Omega$ , the load is  $15\mu H + 4\Omega + 15\mu H$ .
- (3) Typical values represent most likely parametric norms at  $T_A = +25^\circ C$ , and at the Recommended Operation Conditions at the time of product characterization and are not ensured.
- (4) Datasheet min/max specification limits are specified by test or statistical analysis.

**Timing Characteristics<sup>(1)(2)</sup> (continued)**

The following specifications apply for Headphone:  $A_v = 0\text{dB}$ ,  $R_{L(LS)} = 8\Omega$ ,  $R_{L(HP)} = 32\Omega$ ,  $f = 1\text{kHz}$ , unless otherwise specified. Limits apply for  $T_A = 25^\circ\text{C}$ .

Symbol	Parameter	Conditions	LM49450		Units (Limits)
			Typical <sup>(3)</sup>	Limit <sup>(4)</sup>	
$t_{DHT}$	DATA Hold Time from BCLK Rising Edge			10	ns (min)
<b>CONTROL INTERFACE TIMING</b>					
	SCLK Frequency			400	kHz (max)
1	Hold Time (repeated START Condition)			0.6	$\mu\text{s}$ (min)
2	Clock Low Time			1.3	$\mu\text{s}$ (min)
3	Clock High Time			600	ns (min)
4	Setup Time for a Repeated START Condition			600	ns (min)
5	Data Hold Time	Output		300	ns (min)
		Input		0 900	ns (min) ns (max)
6	Data Setup Time			100	ns (min)
7	Rise Time of SDA and SCL			$20+0.1C_B$ 300	ns (min) ns (max)
8	Fall Time of SDA and SCL			$15+0.1C_B$ 300	ns (min) ns (max)
9	Setup Time for STOP Condition			600	ns (min)
10	Bus Free time Between a STOP and START Condition			1.3	$\mu\text{s}$ (min)
$C_B$	Bus Capacitance			10	pF (min)
				200	pF (max)

**PIN DESCRIPTIONS**

Pin	Name	Description
1	C1P	Charge Pump Flying Capacitor Positive Terminal
2	CPGND	Charge Pump Ground
3	SDA	I <sup>2</sup> C Serial Data Input
4	DGND	Digital Ground
5	I <sup>2</sup> S_WS	I <sup>2</sup> S Word Select Input
6	I <sup>2</sup> S_SDI	I <sup>2</sup> S Serial Data Input
7	I <sup>2</sup> S_CLK	I <sup>2</sup> S Clock Input
8	MCLK	Master Clock
9	SCL	I <sup>2</sup> C Clock Input
10	DV <sub>DD</sub>	Digital Core Power Supply
11	IOV <sub>DD</sub>	Digital Interface Power Supply
12	GND	Analog Ground
13	REF	DAC Reference Bypass
14	INR	Right Channel Analog Input
15	INL	Left Channel Analog Input
16	V <sub>DD</sub>	Analog Power Supply
17	BYPASS	Mid-Rail Bias Bypass
18, 24	LSV <sub>DD</sub>	Speaker Power Supply
19	LLS+	Left Channel Non-Inverting Speaker Output
20	LLS-	Left Channel Inverting Speaker Output
21	LSGND	Speaker Ground

**PIN DESCRIPTIONS (continued)**

<b>Pin</b>	<b>Name</b>	<b>Description</b>
22	RLS-	Right Channel Inverting Speaker Output
23	RLS+	Right Channel Non-Inverting Speaker Output
25	HPGND	Headphone Amplifier Ground
26	HPS	Headphone Sense Input
27	HPR	Right Channel Headphone Amplifier Output
28	HPV <sub>DD</sub>	Headphone Amplifier Power Supply
29	HPL	Left Channel Headphone Amplifier Output
30	HPV <sub>SS</sub>	Charge Pump Output and Headphone Amplifier Negative Power Supply.
31	C1N	Charge Pump Flying Capacitor Negative Terminal
32	CPV <sub>DD</sub>	Charge Pump Power Supply

### Typical Performance Characteristics

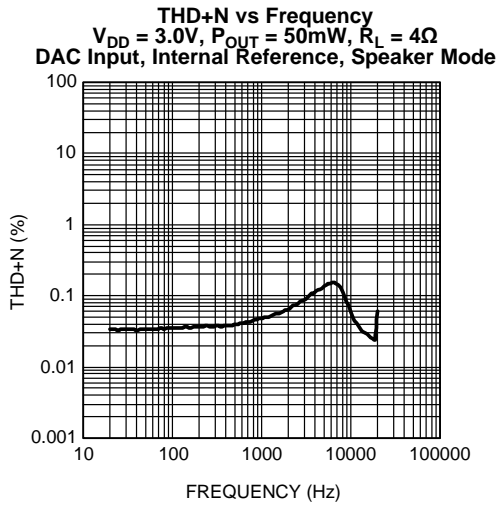

Figure 3.

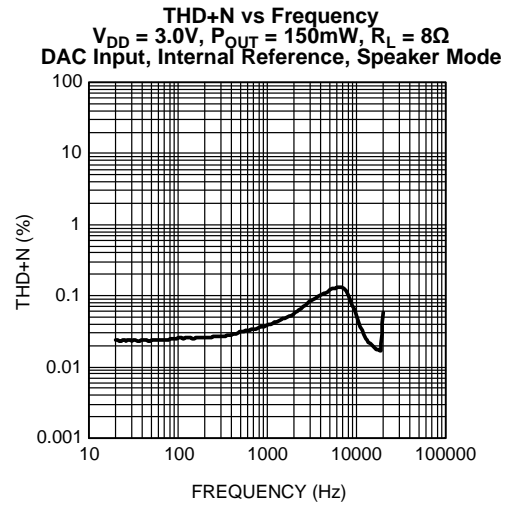

Figure 4.

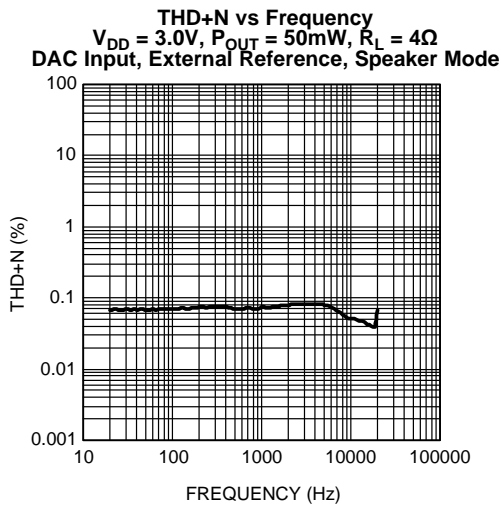

Figure 5.

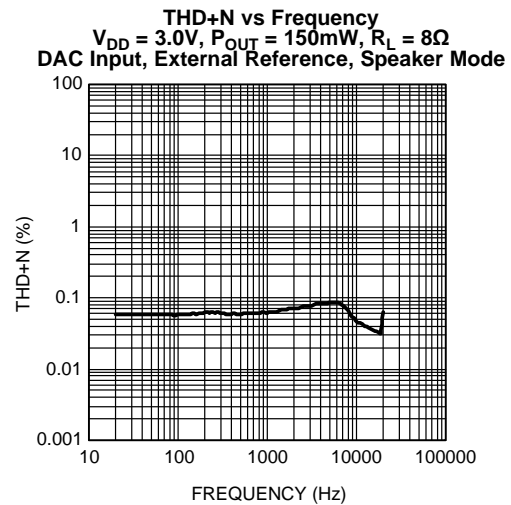

Figure 6.

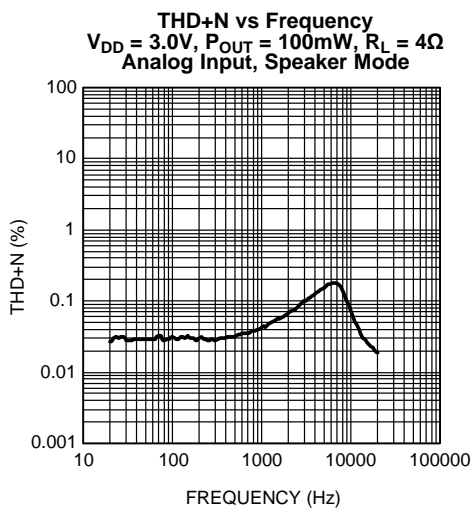

Figure 7.

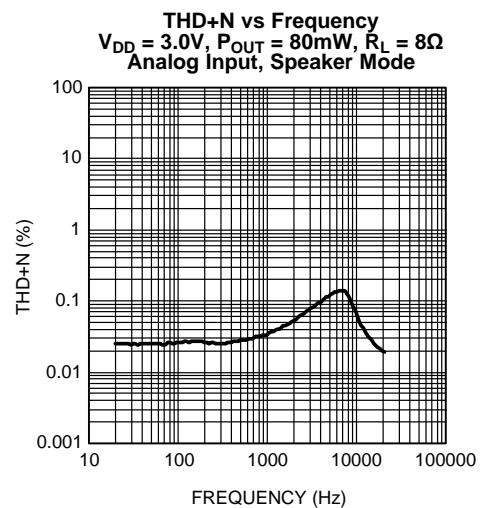

Figure 8.

**Typical Performance Characteristics (continued)**

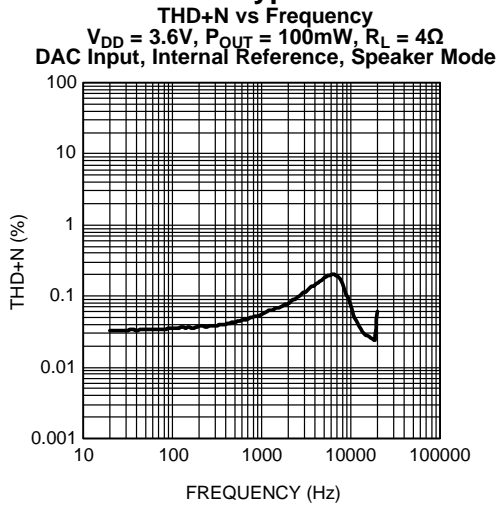

Figure 9.

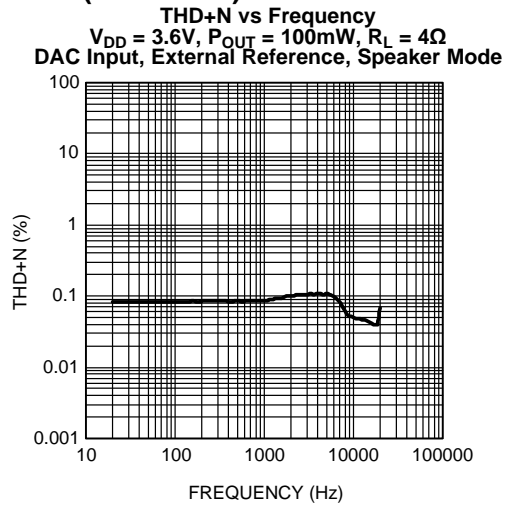

Figure 10.

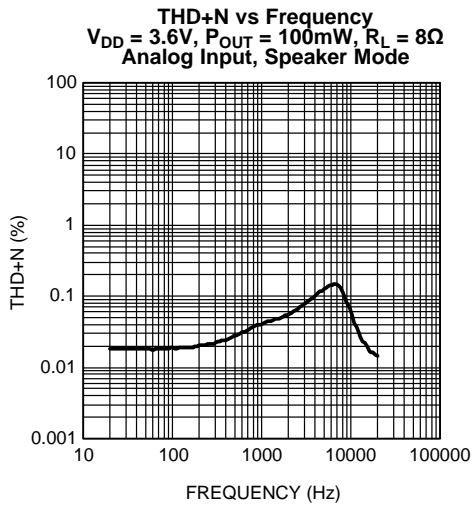

Figure 11.

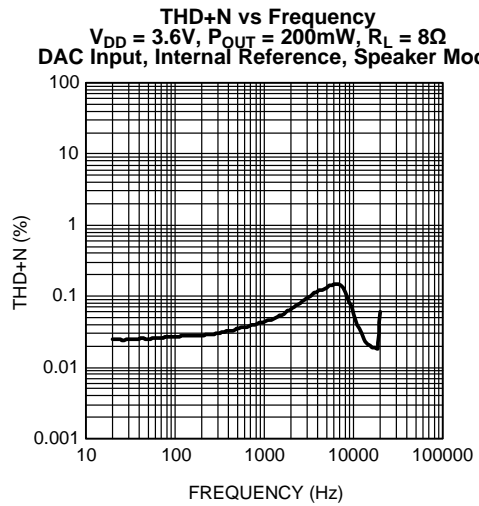

Figure 12.

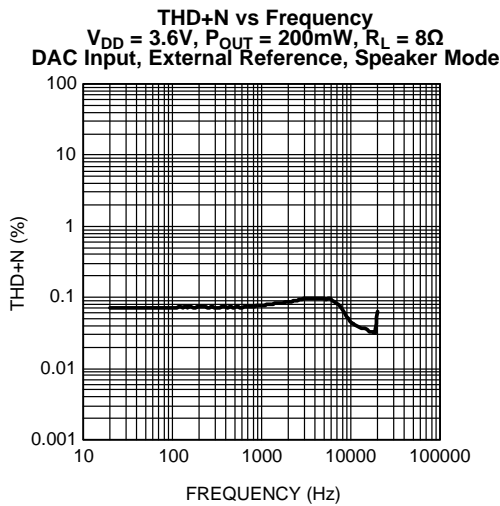

Figure 13.

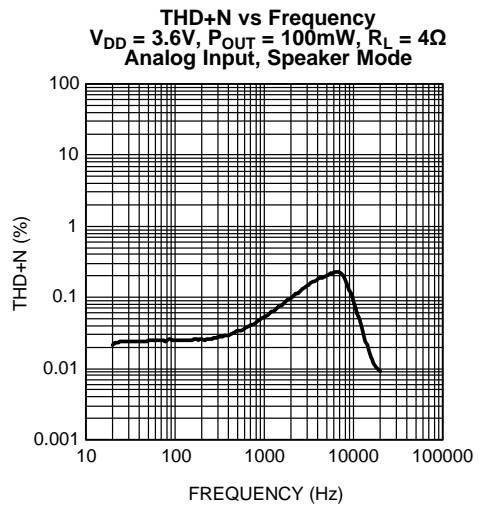

Figure 14.

**Typical Performance Characteristics (continued)**

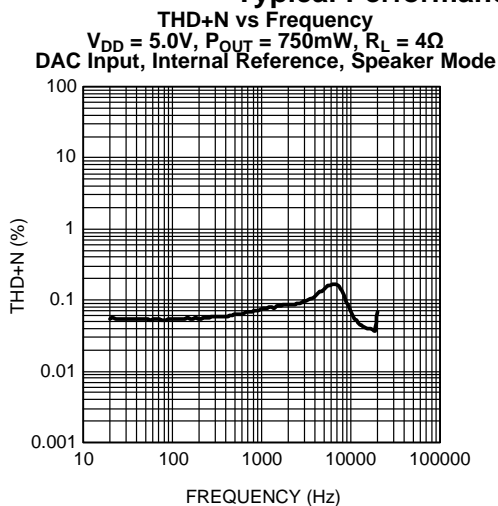

Figure 15.

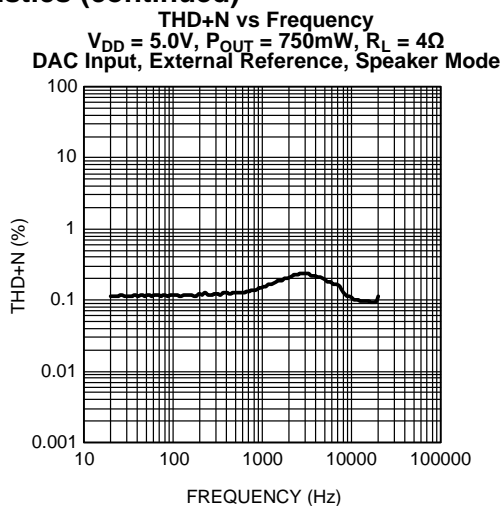

Figure 16.

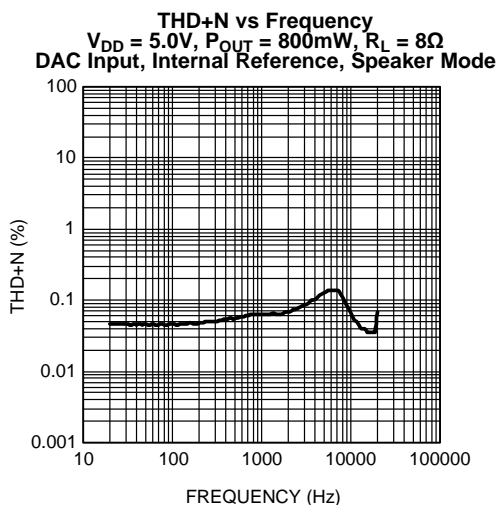

Figure 17.

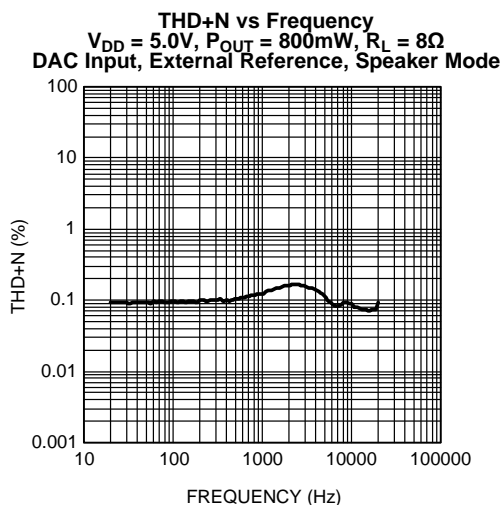

Figure 18.

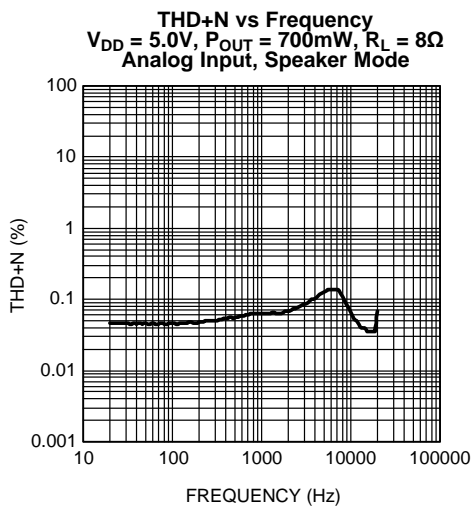

Figure 19.

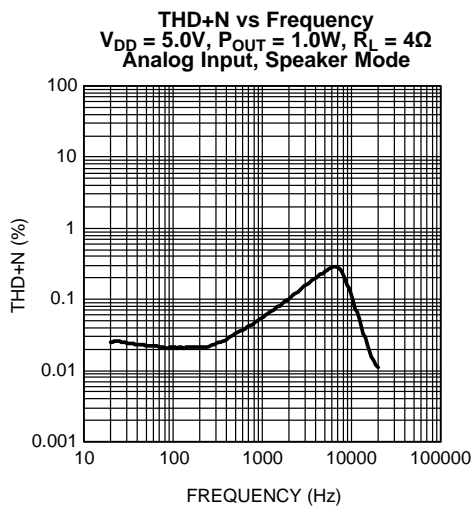

Figure 20.

**Typical Performance Characteristics (continued)**

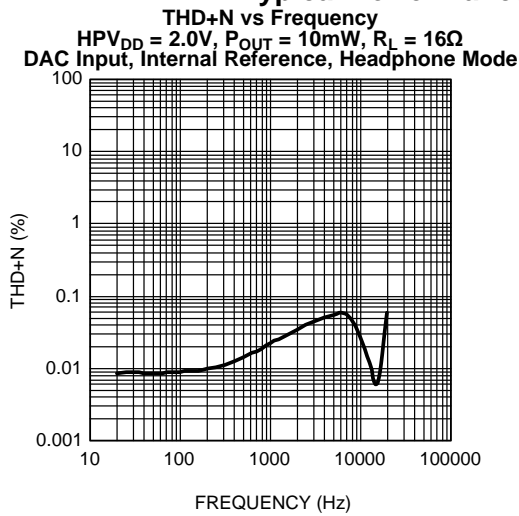

Figure 21.

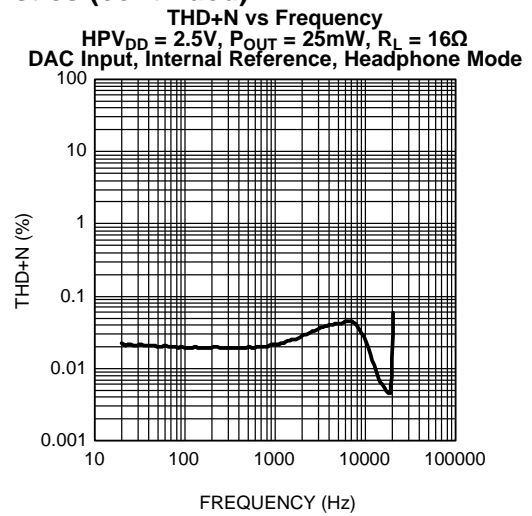

Figure 22.

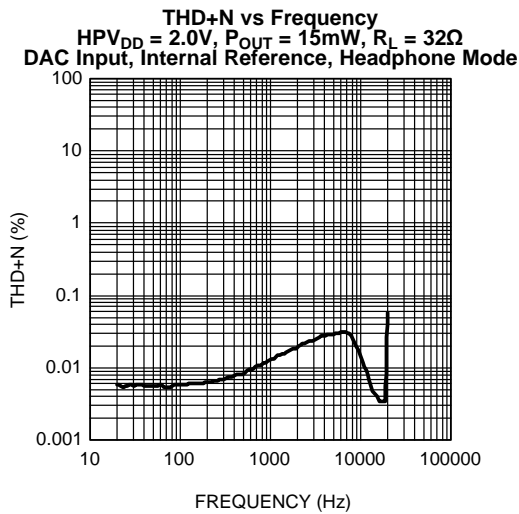

Figure 23.

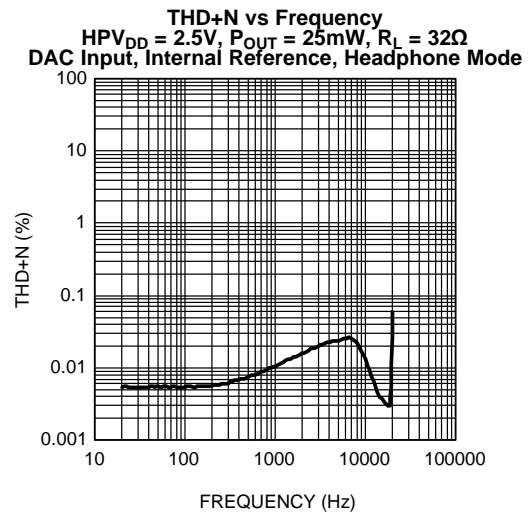

Figure 24.

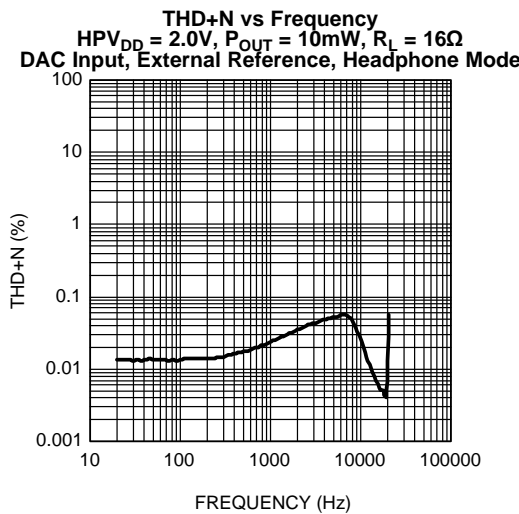

Figure 25.

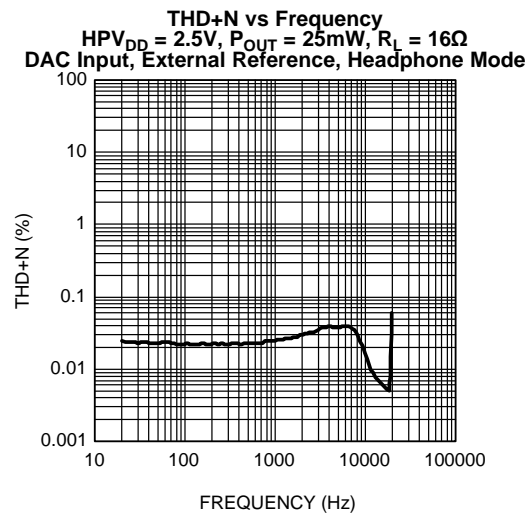

Figure 26.

Typical Performance Characteristics (continued)

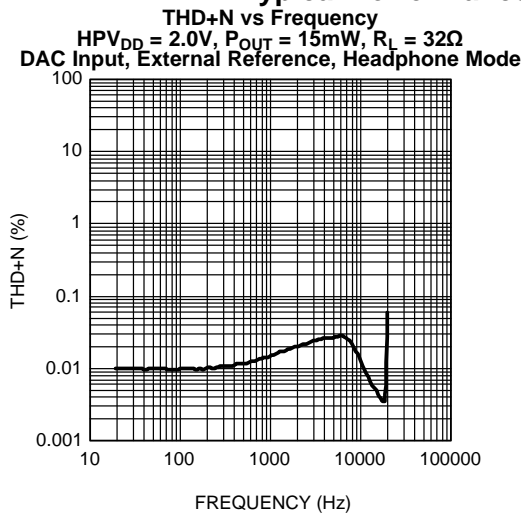

Figure 27.

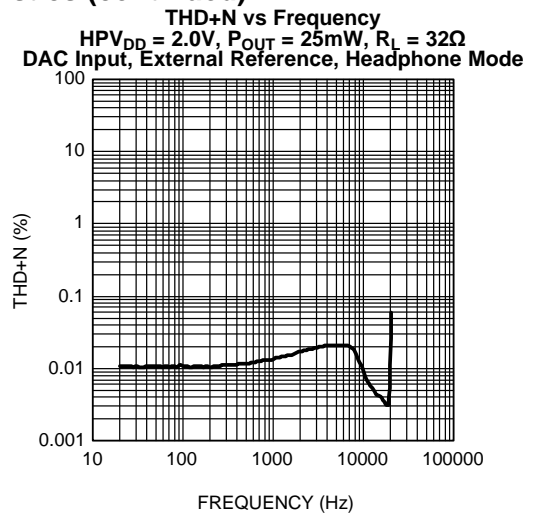

Figure 28.

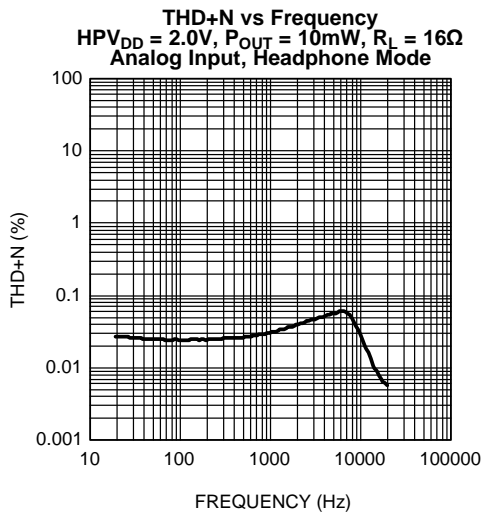

Figure 29.

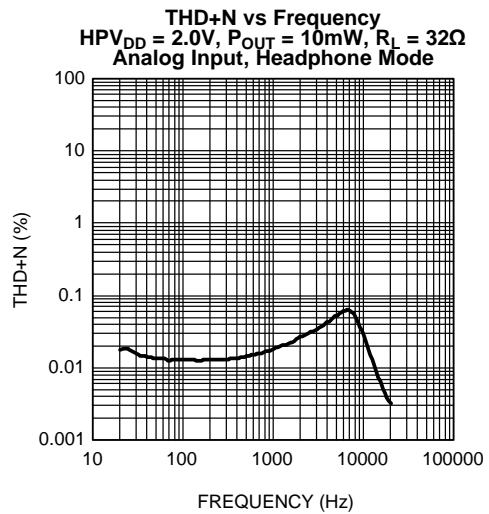

Figure 30.

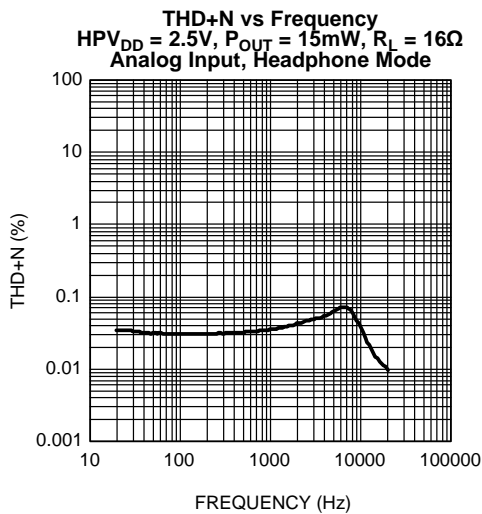

Figure 31.

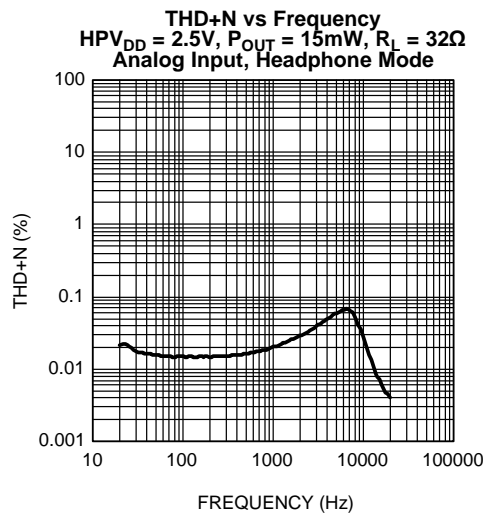

Figure 32.

**Typical Performance Characteristics (continued)**

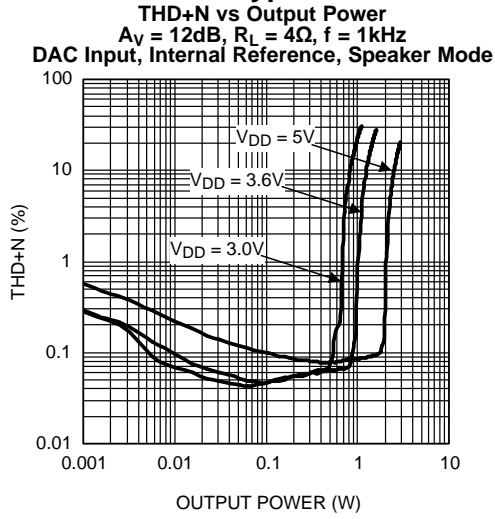

Figure 33.

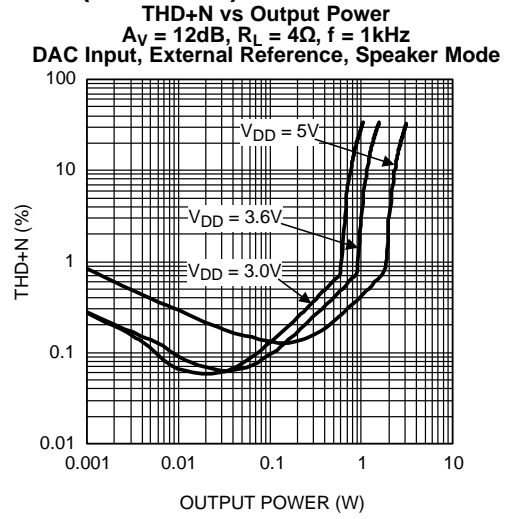

Figure 34.

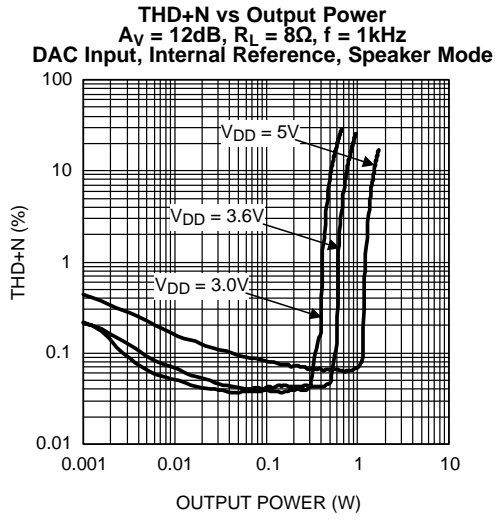

Figure 35.

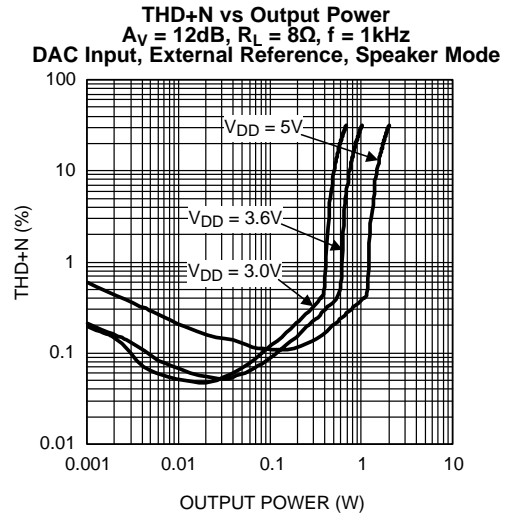

Figure 36.

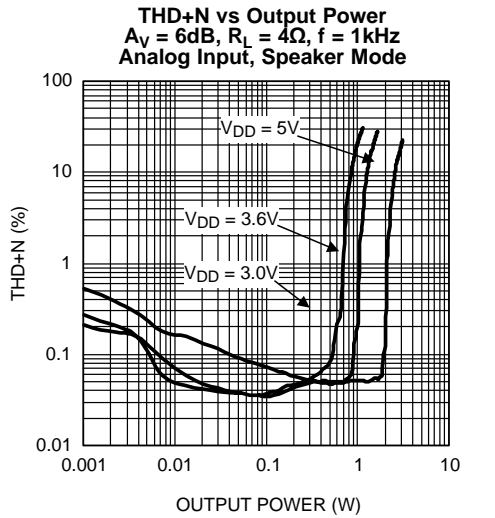

Figure 37.

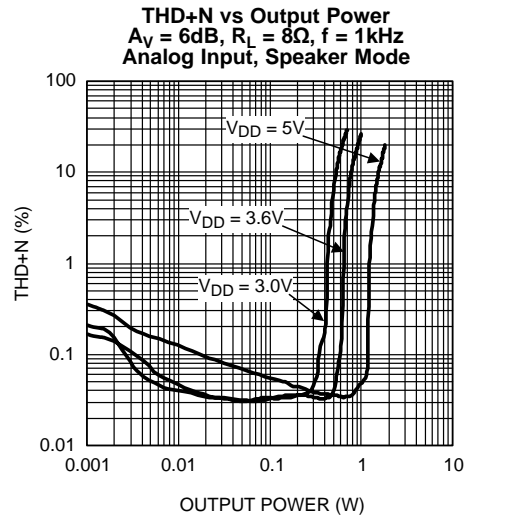

Figure 38.

Typical Performance Characteristics (continued)

**THD+N vs Output Power**  
 $A_V = 9\text{dB}$ ,  $R_L = 16\Omega$ ,  $f = 1\text{kHz}$   
 DAC Input, Internal Reference, Headphone Mode

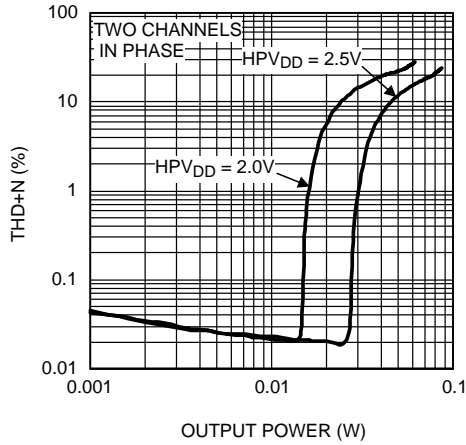

Figure 39.

**THD+N vs Output Power**  
 $A_V = 9\text{dB}$ ,  $R_L = 16\Omega$ ,  $f = 1\text{kHz}$   
 DAC Input, External Reference, Headphone Mode

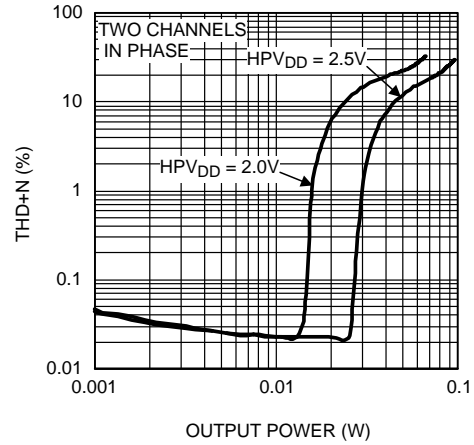

Figure 40.

**THD+N vs Output Power**  
 $A_V = 9\text{dB}$ ,  $R_L = 32\Omega$ ,  $f = 1\text{kHz}$   
 DAC Input, External Reference, Headphone Mode

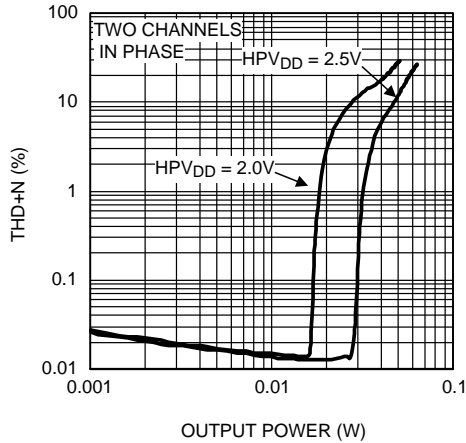

Figure 41.

**THD+N vs Output Power**  
 $A_V = 0\text{dB}$ ,  $R_L = 16\Omega$ ,  $f = 1\text{kHz}$   
 Analog Input, Headphone Mode

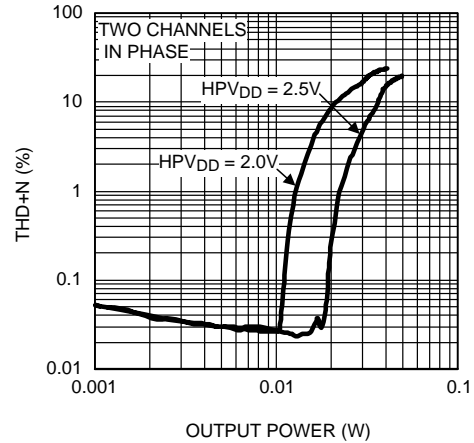

Figure 42.

**THD+N vs Output Power**  
 $A_V = 0\text{dB}$ ,  $R_L = 32\Omega$ ,  $f = 1\text{kHz}$   
 Analog Input, Headphone Mode

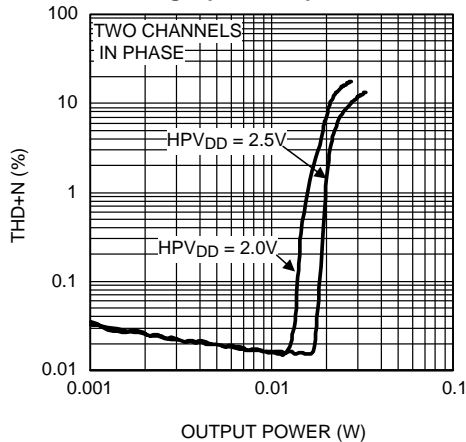

Figure 43.

**PSRR vs Frequency**  
 $V_{DD} = 3.6\text{V}$ ,  $V_{RIPPLE} = 200\text{mV}_{P-P}$ ,  $R_L = 8\Omega$   
 DAC Input, Internal Reference, Speaker Mode

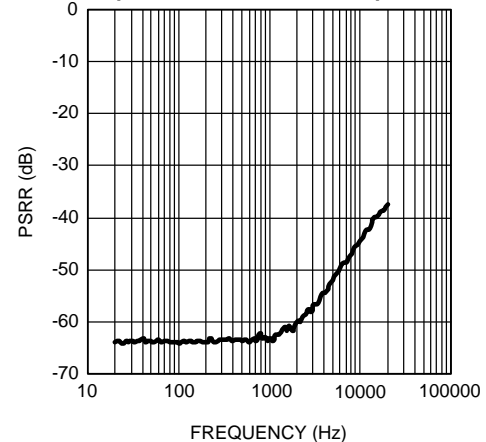

Figure 44.

**Typical Performance Characteristics (continued)**

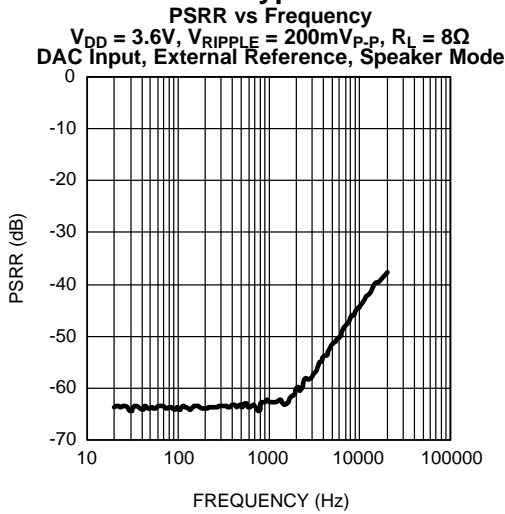

Figure 45.

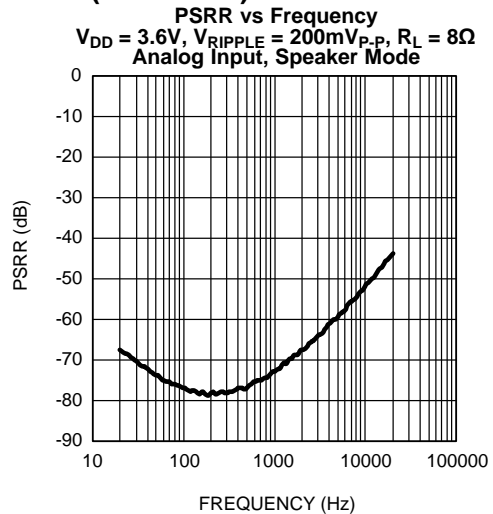

Figure 46.

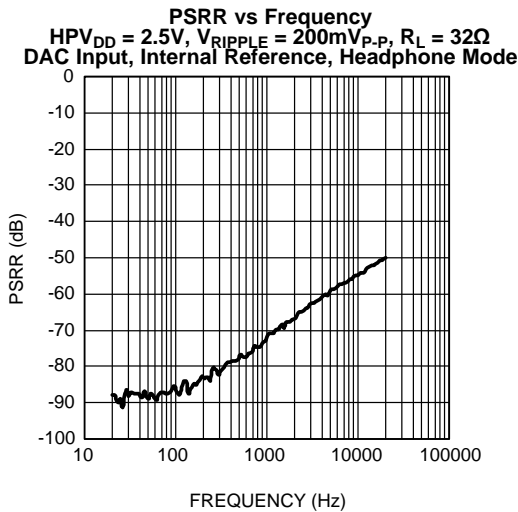

Figure 47.

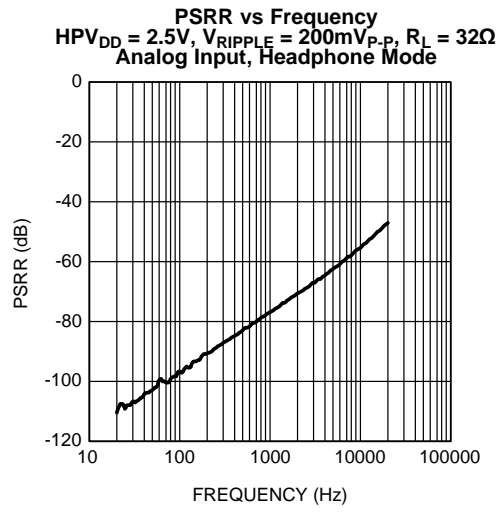

Figure 48.

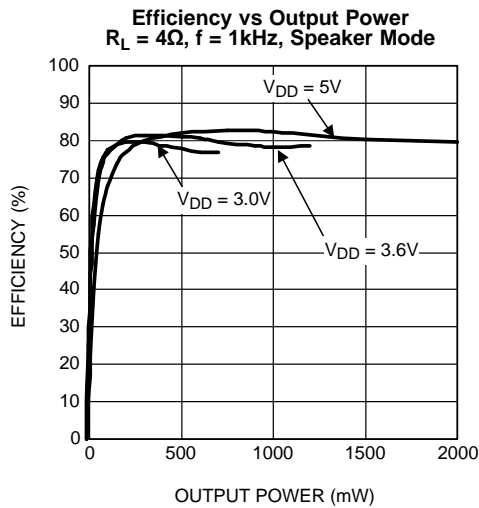

Figure 49.

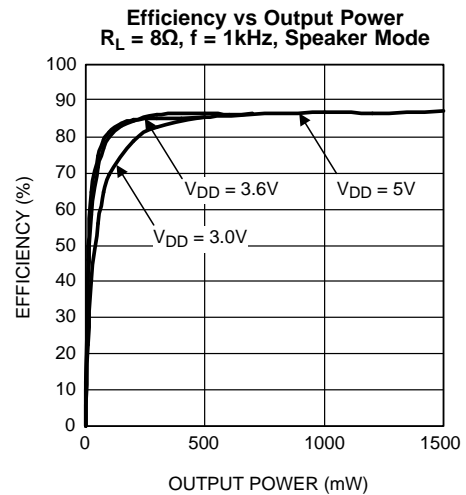

Figure 50.

Typical Performance Characteristics (continued)

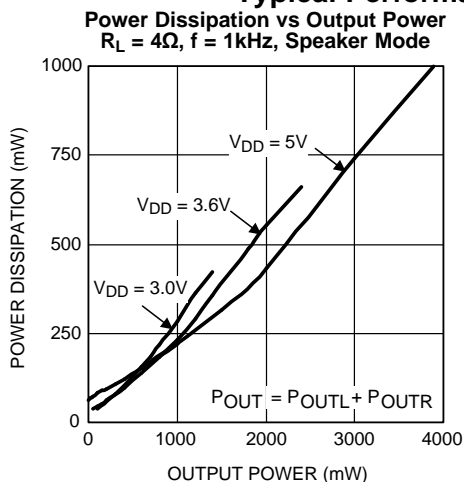

Figure 51.

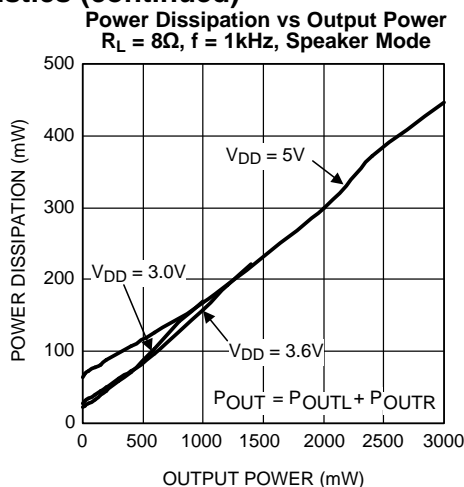

Figure 52.

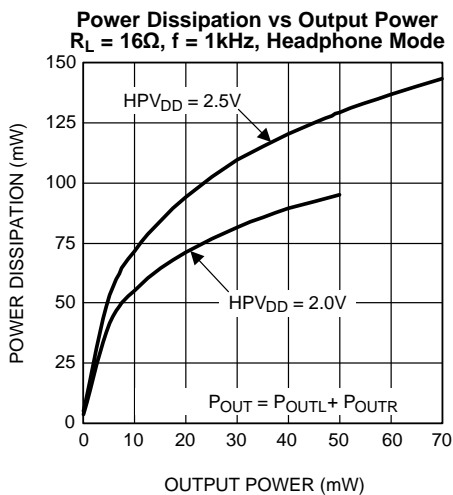

Figure 53.

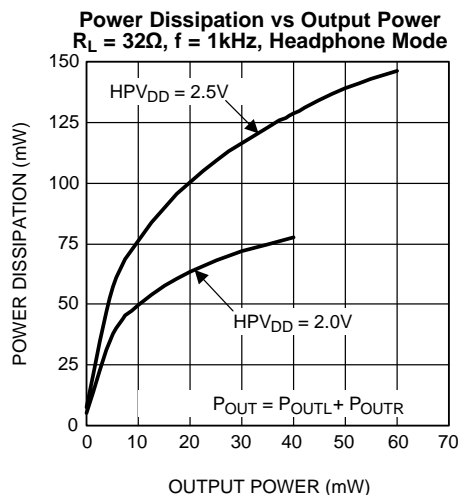

Figure 54.

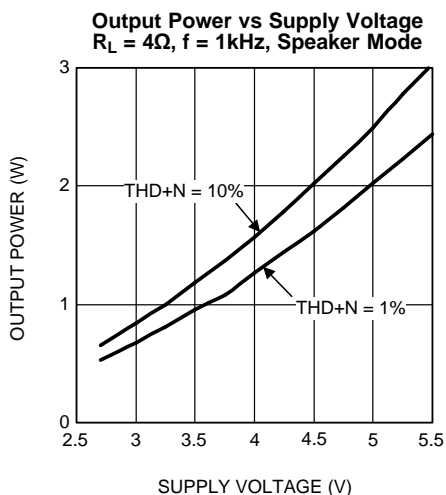

Figure 55.

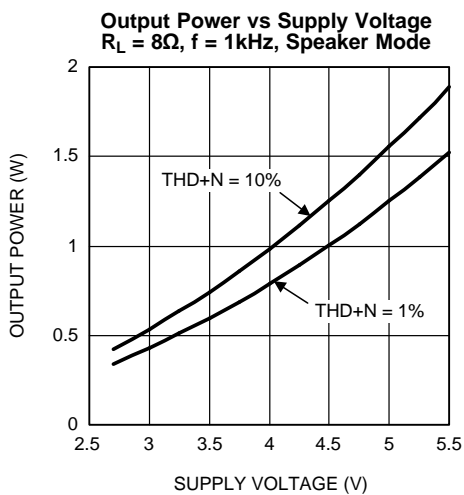

Figure 56.

**Typical Performance Characteristics (continued)**

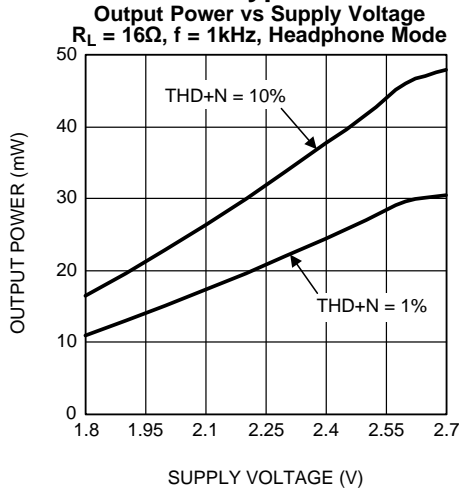

Figure 57.

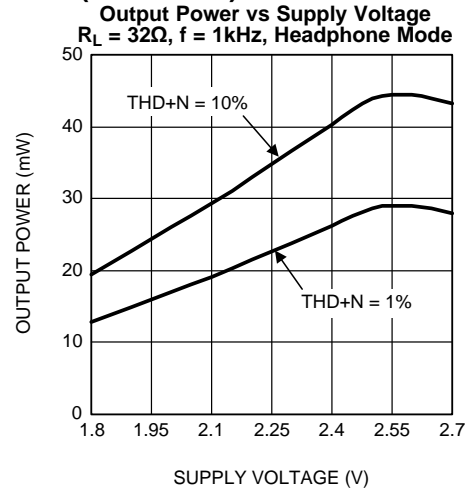

Figure 58.

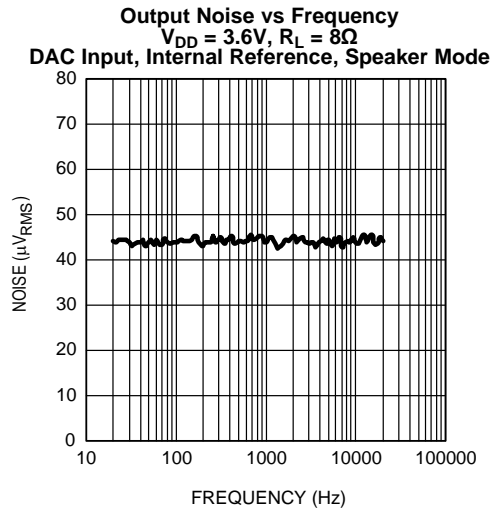

Figure 59.

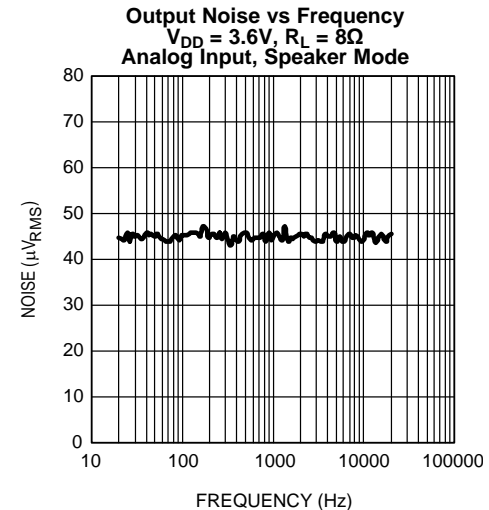

Figure 60.

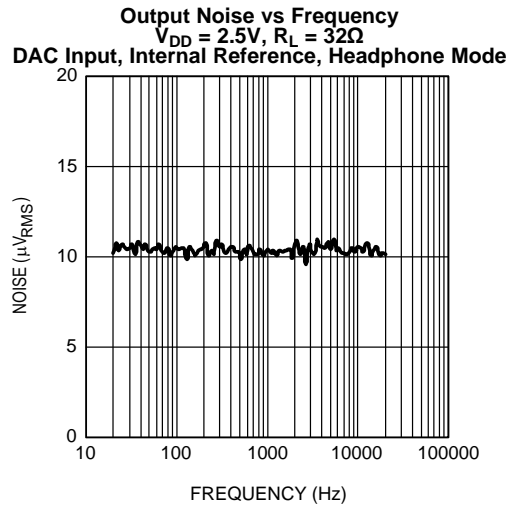

Figure 61.

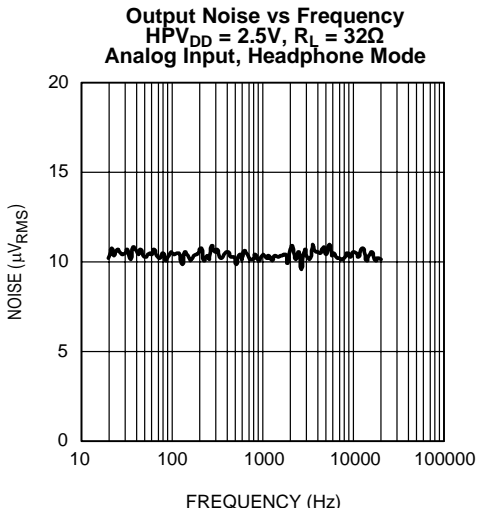
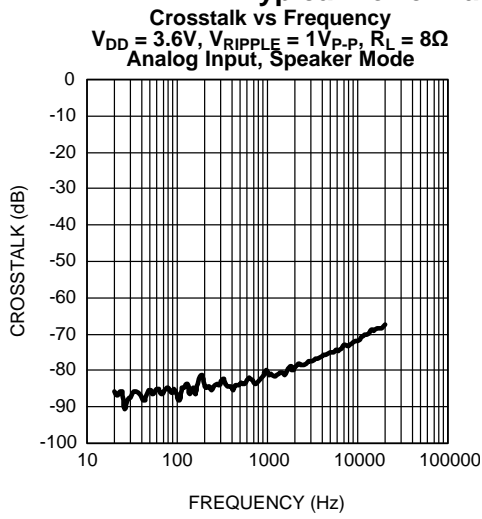
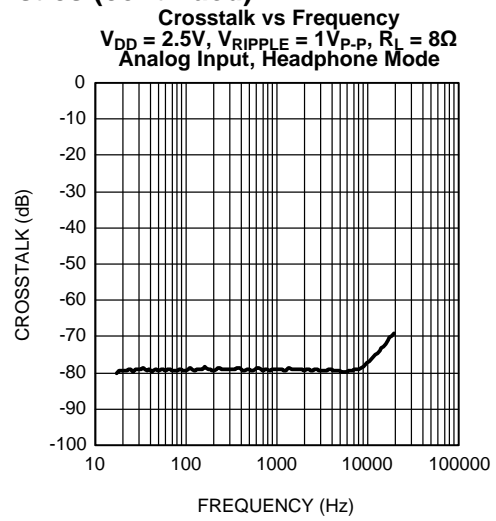

Figure 62.

**Typical Performance Characteristics (continued)**



**Figure 63.**



**Figure 64.**

## APPLICATION INFORMATION

### I<sup>2</sup>C-COMPATIBLE INTERFACE

The LM49450 is controlled through an I<sup>2</sup>C-compatible serial interface that consists of a serial data line (SDA) and a serial clock (SCL). The clock line is uni-directional. The data line is bi-directional (open collector). The LM49450 and the master can communicate at clock rates up to 400kHz. Figure 65 shows the I<sup>2</sup>C interface timing diagram. Data on the SDA line must be stable during the HIGH period of SCL. The LM49450 is a transmit/receive slave-only device, reliant upon the master to generate the SCL signal. Each transmission sequence is framed by a START condition and a STOP condition (Figure 66). Each data word, register address and register data, transmitted over the bus is 8 bits long as is always followed by an acknowledge pulse (Figure 67). The LM49450 device address is 1111101.

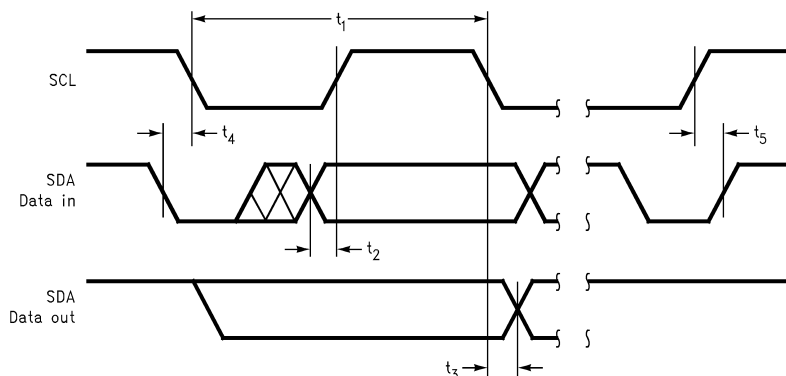

Figure 65. I<sup>2</sup>C Timing Diagram

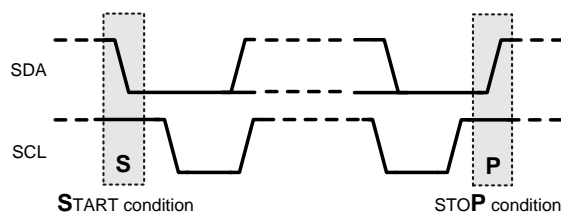

Figure 66. START and STOP Diagram



Figure 67. Example I<sup>2</sup>C Write Cycle

### BUS FORMAT

The I<sup>2</sup>C bus format is shown in Figure 69. The START signal, the transition of SDA from HIGH to LOW while SDA is HIGH, is generated, altering all devices on the bus that a device address is being written to the bus.

The 7-bit device address is written to the bus, most significant bit (MSB) first, followed by the R/W bit ( $R/\bar{W} = 0$  indicates the master is writing to the LM49450,  $R/\bar{W} = 1$  indicates the master wants to read data from the LM49450). The data is latched in on the rising edge of the clock. Each address bit must be stable while SDA is HIGH. After the last address bit is transmitted, the master device releases SDA, during which time, an acknowledge clock pulse is generated by the slave device. If the LM49450 receives the correct address, the device pulls the SDA line low, generating an acknowledge bit (ACK).

Once the master device registers the ACK bit, the 8-bit register address word is sent. Each data bit should be stable while SCL is HIGH. After the 8-bit register address is sent, the LM49450 sends another ACK bit. Following the acknowledgement of the register address, the 8-bit register data word is sent. Each data bit should be stable while SCL is HIGH. After the 8-bit register data is sent, the LM49450 sends another ACK bit. Following the acknowledgement of the register data word, the master issues a STOP bit, allowing SDA to go high while SDA is high.

### I<sup>2</sup>S DATA FORMAT

The LM49450 supports three I<sup>2</sup>S formats: Normal Mode (Figure 68), Left Justified Mode (Figure 69), and Right Justified Mode (Figure 70). In Normal Mode, the audio data is transmitted MSB first, with the unused bits following the LSB. In Left Justified Mode, the audio data format is similar to the Normal Mode, without the delay between the LSB and the change in I<sup>2</sup>S\_WS. In Right Justified Mode, the audio data MSB is transmitted after a delay of a preset number of bits.

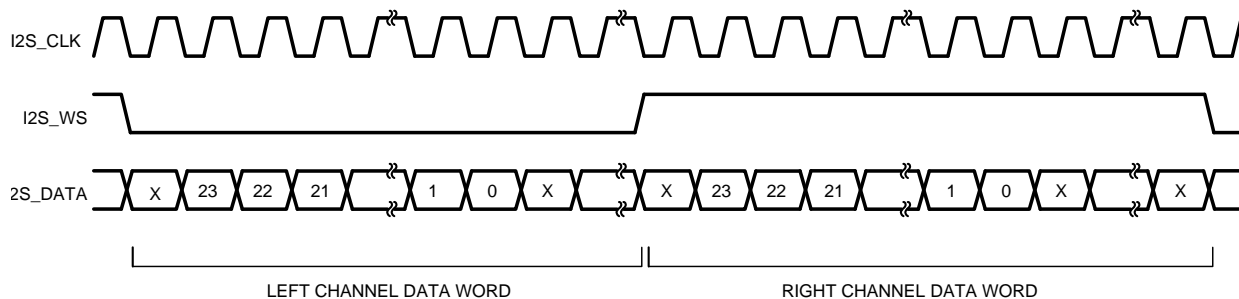

Figure 68. I<sup>2</sup>S Normal Input Format

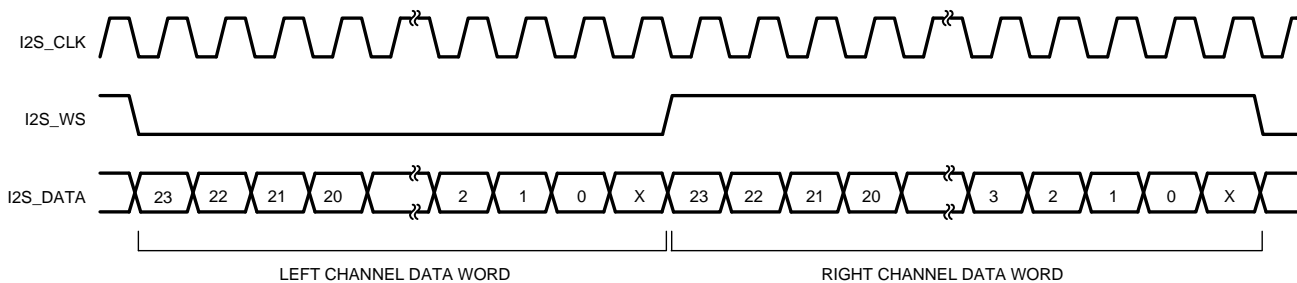

Figure 69. I<sup>2</sup>S Left-Justified Input Format

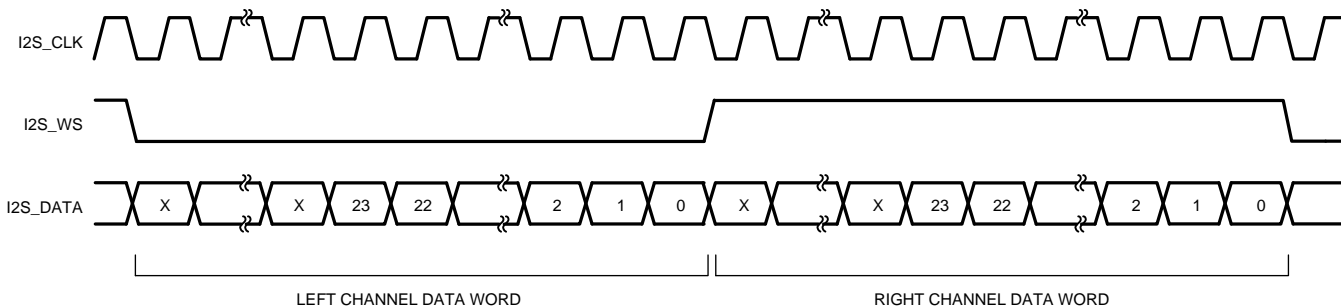

Figure 70. I<sup>2</sup>S Right-Justified Input Format

## GENERAL AMPLIFIER FUNCTION

### Class D Amplifier

The LM49450 features a high-efficiency stereo Class D audio power amplifier that utilizes TI's filterless modulation scheme which reduces external component count, conserves board space and reduces system cost. The Class D outputs transition between  $V_{DD}$  and GND with a 300kHz switching frequency. With no signal applied, the outputs switch with a 50% duty cycle, in phase, causing the two outputs to cancel. This cancellation results in no net voltage across the speaker, thus there is no current to the load in the idle state.

With the input signal applied, the duty cycle (pulse width) of the LM49450 outputs changes. For increasing output voltage, the duty cycle of  $V_{LS+}$  increases while the duty cycle of  $V_{LS-}$  decreases. For decreasing output voltages, the converse occurs. The difference between the two pulse widths yield the differential output voltage.

### Fixed Frequency Mode

The LM49450 features two modulation schemes, a fixed frequency mode and a spread spectrum mode. Select the fixed frequency mode by setting the SS bit (B3) in the Mode Control Register (0x00h) to 0. In fixed frequency mode, the speaker amplifier outputs switch at a constant 300kHz. The output spectrum in fixed frequency mode consists of the fundamental and its associated harmonics (see [Typical Performance Characteristics](#)).

### Spread Spectrum

The logic selectable spread spectrum mode eliminates the need for output filters, ferrite beads or chokes. In spread spectrum mode, the switching frequency varies randomly by 30% about a 300kHz center frequency, reducing the wide-band spectral content, improving EMI emissions radiated by the speaker and associated cables and traces. Where a fixed frequency class D exhibits large amounts of spectral energy at multiples of the switching frequency, the spread spectrum architecture of the LM49450 spreads that energy over a larger bandwidth (see [Typical Performance Characteristics](#)). The cycle-to-cycle variation of the switching period does not affect the audio reproduction, efficiency, or PSRR. Set the SS bit (B3) in the Mode Control Register (0x00h) to 1 to select spread spectrum mode.

### Headphone Amplifier

The LM49450 headphone amplifiers feature TI's ground referenced architecture that eliminates the large DC-blocking capacitors required at the outputs of traditional headphone amplifiers. A low-noise inverting charge pump creates a negative supply ( $HPV_{SS}$ ) from the positive supply voltage ( $CPV_{DD}$ ). The headphone amplifiers operate from these bipolar supplies, with the amplifier outputs biased about GND, instead of a nominal DC voltage (typically  $V_{DD}/2$ ), like traditional amplifiers. Because there is no DC component to the headphone output signals, the large DC-blocking capacitors (typically 220 $\mu$ F) are not necessary, conserving board space and system cost, while improving frequency response.

### Power Supplies

The LM49450 uses different power supplies for each portion of the device, allowing for the optimum combination of headroom, power dissipation and noise immunity. The analog input, and gain (volume control) stages for both speaker and headphones are powered from  $V_{DD}$ . The speaker output stage is powered from  $LSV_{DD}$ . The headphone amplifiers and charge pump are powered from  $HPV_{DD}$ . The separate power supplies allow the class D amplifiers to operate from a higher voltage, maximizing headroom, while the headphones operate from a lower voltage, improving power dissipation, as well as minimizing switching noise coupling between the speaker and headphone amplifiers. The digital portion of the device is powered from  $DV_{DD}$ , including the 3D processing core and DAC.  $IOV_{DD}$  powers the I<sup>2</sup>S and I<sup>2</sup>C, allowing the LM49450 to interface with lower voltage digital controllers.

### TI's 3D Enhancement

The LM49450 digital audio path features TI's 3D enhancement that widens or narrows the perceived soundstage of a stereo audio signal. The 3D enhancement either increases or decreases the apparent stereo channel separation, improving audio reproduction whenever the placement of both left and right speakers is not ideal.

The LM49450 3D function is controlled through the I<sup>2</sup>C interface. The headphone and speakers have independent 3D controls, allowing each signal path to have its own individual 3D configuration. The LM49450 3D features two effect modes, a narrow effect that decreases the channel separation, making the speakers sound closer together, and a wide effect that makes the speakers sound farther apart. Because the narrow effect mode adds a portion of the left and right signals together, a selectable 6dB attenuation mode is provided to maintain a constant output amplitude when the narrow effect mode is active without changing the volume level. The high pass 3dB roll off frequency, 3D gain (amount channel mixing), and narrow/wide effect selection is done through registers 0x05h (headphone) and 0x06h (speaker). See the [Headphone 3D Configuration Register](#) and [Headphone 3D Configuration Register](#) sections for more information.

### Headphone Sense

The LM49450 features a headphone sense input (HPS) that monitors the headphone jack and configures the device depending on the presence of a headphone. When the HPS pin is low, indicating that a headphone is not present, the LM49450 speaker amplifiers are active and the headphone amplifiers are disabled. When the HPS pin is high, indicating that a headphone is present, the headphone amplifiers are active while the speaker amplifiers are disabled.

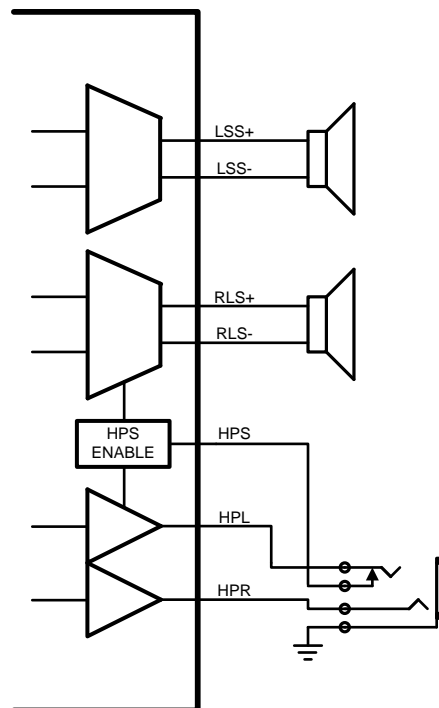

Figure 71. HPS Connection

### Volume Control

The LM49450 features two separate 32-step volume controls, one for the speaker channels and one for the headphone channels. This allows for the gain of the headphone and speakers to be set independently of each other.

### External Reference

The LM49450 can be used with an external reference. Disable the internal reference by setting bit B7 of the Mode Control Register (0x00h) to 1. This allows an external reference voltage to be applied to REF. For proper operation, do not allow the  $V_{REF}$  to exceed  $V_{DD}$ .

## Low Power Shutdown

The LM49450 features an I<sup>2</sup>C selectable low power shutdown mode that disables the entire device, reducing quiescent current consumption to 0.05µA (digital + analog current). Set bit B0 in the mode control register (0x00h) to 0 to disable the device. Set B0 to 1 to enable the device.

## I<sup>2</sup>S CLOCK CONTROL

The LM49450 features the ability to derive multiple clock signals, including the DAC clock, I<sup>2</sup>S clock and word select clock in master mode, and the charge pump oscillator frequency, from the MCLK input.

### DAC Clock Divider (RDIV)

Bits B5-B0 in the CLOCK CONTROL register (0x01h) are the RDIV bits that set the DAC clock divider ratio. The DAC clock derived from MCLK needs to match the DAC sampling rate. For example, with  $f_{MCLK} = 12.288\text{MHz}$  and a  $64 \cdot f_s$  oversampling ratio ( $f_s = 48\text{kHz}$ ), the DAC requires a 6.144MHz clock. In this case, set the RDIV ratio to divide by 2. In other instances, there may not be a suitable divider ratio for a given sampling rate and MCLK frequency. In this case,  $f_{MCLK}$  may need to be altered. See the [Clock Control Register](#) section for more information.

### I<sup>2</sup>S WS Clock Dividers (I<sup>2</sup>S\_CLK, WS\_CLK)

In I<sup>2</sup>S master mode, the LM49450 I<sup>2</sup>S CLOCK CONTROL register (0x04h) can be used to set the I<sup>2</sup>S clock and WS clock frequency. In I<sup>2</sup>S clock master mode, bits B7-B4 of the I<sup>2</sup>S CLOCK CONTROL register, the I<sup>2</sup>S\_CLK bits, set the I<sup>2</sup>S clock divider ratio. The LM49450 derives the I<sup>2</sup>S clock from DAC clock based on the ratio set by the I<sup>2</sup>S\_CLK bits. The I<sup>2</sup>S clock is output on I<sup>2</sup>S\_CLK.

In I<sup>2</sup>S master mode, bits B3 and B2 (I<sup>2</sup>S\_WS) of the I<sup>2</sup>S CLOCK CONTROL register set the bit length per data word of the I<sup>2</sup>S WS.

### Charge Pump Clock Divider (CPDIV)

The ground referenced headphone amplifiers charge pump derives its clock from MCLK. Bits B7-B0 of the CHARGE PUMP CLOCK register (0x02h) set the charge pump clock divider ratio. See the [Charge Pump Clock Register](#) section for more information.

**Table 1. CONTROL REGISTERS — Register Map**

Register Address	Register Name	B7	B6	B5	B4	B3	B2	B1	B0
0x00h	MODE CONTROL	EXT_REF	DAC_MODE_DE_1	DAC_MODE_0	COMP	SS	MUTE	LINE_IN	ENABLE
0x01h	CLOCK	DAC_DITHER_OFF	DAC_DITHER_ON	RDIV_5	RDIV_4	RDIV_3	RDIV_2	RDIV_1	RDIV_0
0x02h	CHARGE PUMP CLOCK FREQUENCY	CPDIV_7	CPDIV_6	CPDIV_5	CPDIV_4	CPDIV_3	CPDIV_2	CPDIV_1	CPDIV_0
0x03h	I <sup>2</sup> S MODE	RESERVE_D	I2S_WRD_2	I2S_WRD_1	I2S_WRD_0	I2S STEREO_REVERSE	I <sup>2</sup> S_WOR D_ORDER	I <sup>2</sup> S_MODE_1_	I <sup>2</sup> S_MODE_0
0x04h	I <sup>2</sup> S CLOCK	I2S_CLK_3	I2S_CLK_2	I2S_CLK_1	I2S_CLK_0	I2S_WS_1	I2S_WS_0	I2S_WS_M S	I2S_CLK_ MS
0x05h	HEADPHONE 3D CONTROL	RESERVE_D	HP_3DAT TN	HP_3DFREQ_1	HP_3DFRE Q_0	HP_3D_GAI N_1	HP_3D_G AIN_0	HP_3D_MO DE	HP_3DEN
0x06h	SPEAKER 3D CONTROL	RESERVE_D	LS_3DAT TN	LS_3DFREQ_1	LS_3DFRE Q_0	LS_3DGAIN_1	LS_3DGAI N_0	LS_3D_MO DE	LS_3DEN
0x07h	HEADPHONE VOLUME CONTROL	RESERVE_D	RESERVE_D	RESERVED	HP4	HP3	HP2	HP1	HP0
0x08h	SPEAKER VOLUME CONTROL	RESERVE_D	RESERVE_D	RESERVED	LS4	LS3	LS2	LS1	LS0
0x09h	CMP_0_LSB	C0_7	C0_6	C0_5	C0_4	C0_3	C0_2	C0_1	C0_0

**Table 1. CONTROL REGISTERS — Register Map (continued)**

Register Address	Register Name	B7	B6	B5	B4	B3	B2	B1	B0
0x0Ah	CMP_0_MSB	C0_15	C0_14	C0_13	C0_12	C0_11	C0_10	C0_09	C0_08
0x0Bh	CMP_1_LSB	C1_7	C1_6	C1_5	C1_4	C1_3	C1_2	C1_1	C1_0
0x0Ch	CMP_1_MSB	C1_15	C1_14	C1_13	C1_12	C1_11	C1_10	C1_09	C1_08
0x0Dh	CMP_2_LSB	C2_7	C2_6	C2_5	C2_4	C2_3	C2_2	C2_1	C2_0
0x0Eh	CMP_2_MSB	C2_15	C2_14	C2_13	C2_12	C2_11	C2_10	C2_09	C2_08

### MODE CONTROL REGISTER (0x00h)

Default value is 0x00h.

**Table 2. Mode Control Register**

Bit	Name	Value		Description
B7	EXT_REF	0		Internal reference selected
		1		External reference selected. See <a href="#">External Reference</a> section.
B6:B5	DAC_MODE_1 (B6) DAC_MODE_0 (B5)	B6	B5	Select DAC over sampling Rate
		0	0	125
		0	1	128
		1	0	64
B4	COMP	0		Default DAC compensation filter selected
		1		Programmable DAC compensation filter selected. See <a href="#">DAC Compensation Filter</a> section.
B3	SS	0		Fixed frequency oscillator selected
		1		Spread spectrum oscillator selected
B2	MUTE	0		Un-mute device
		1		Mute device
B0	ENABLE	0		Device shutdown. Default state during a POR event
		1		Device enabled.

### CLOCK CONTROL REGISTER (0x01h)

Default value is 0x00h.

**Table 3. Clock Control Register**

Bit	Name	Value				Description
B7	DAC_DITHER_OFF	0				Default DAC state
		1				Permanently disables DAC dither
B6	DAC_DITHER_ON	0				Default DAC state
		1				Permanently enables DAC dither

**Table 3. Clock Control Register (continued)**

Bit	Name	Value						Description
		B5	B4	B3	B2	B1	B0	
B5:B0	RDIV_5 (B5) RDIV_4 (B4) RDIV_3 (B3) RDIV_2 (B2) RDIV_1 (B1) RDIV_0 (B0)	Sets MCLK divider ratio						
		Bypass divider						
		0	0	0	0	0	0	1
		0	0	0	0	1	0	1.5
		0	0	0	0	1	1	2
		0	0	0	1	0	0	2.5
		0	0	0	1	0	1	5
		TO						In 0.5 increments
		1	1	1	1	0	1	31
		1	1	1	1	1	0	31.5
		1	1	1	1	1	1	32

**CLK NETWORK**

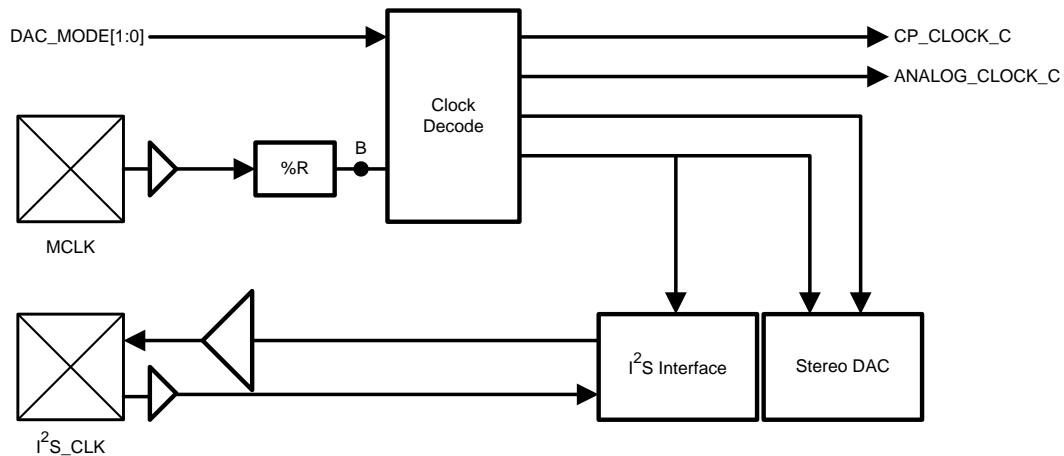

**Figure 72. CLK Network Diagram**

**LM49450 Clock Structure**

The MCLK input is first divided by the R divider to product the clock at point B; this is then decoded according to the DAC\_MODE to produce a signal which goes to both the DAC digital and the I2S interface, and a signal which goes to the DAC analog.

This table describes the relationship between the clocks, for each of the four possible DAC modes in terms of audio input sampling frequency fs.

**Table 4. Relationship between clocks for each of the four DAC modes**

DAC MODE	Description			
	OSR	CLK at B	DAC Digital CLK	DAC Analog CLK
00	125	250fs	250fs	125fs
01	128	256fs	128fs	128fs
10	64	128fs	128fs	64fs
11	32	128fs	128fs	32fs

### Common Clock Settings for the DAC

In DAC\_MODE 0, the DAC has an oversampling rate (OSR) of 125 but requires a 250xfs clock at point B. This allows a simple clocking solution as it will work from 12.000MHz (common in most systems with Bluetooth or USB) at 48kHz exactly. In the other DAC modes, the DAC requires a conventional  $2^N \times$ fs clock for conversation. The following table describes the clock required at point B for various clock sample rates in the different DAC modes:

**Table 5. Common DAC Clock Frequencies**

Sample Rate	Clock Required at B (MHz)			
	DAC MODE = 2b00 (OSR = 125fs, Clock Required = 250fs)	DAC MODE = 2b01 (OSR = 128fs, Clock Required = 256fs)	DAC MODE = 2b10 (OSR = 64fs, Clock Required = 128fs)	DAC MODE = 2b11 (OSR = 32fs, Clock Required = 128fs)
8	2	2.048	—	—
11.025	2.75625	2.8224	—	—
12	3	3.072	—	—
16	4	4.096	—	—
22.05	5.5125	5.6448	—	—
24	6	6.144	—	—
32	8	8.192	—	—
44.1	11.025	11.2896	—	—
48	—	12.288	—	—
88.2	—	—	11.2896	—
96	—	—	12.288	—
176.4	—	—	—	22.5792
192	—	—	—	24.576

### CHARGE PUMP CLOCK REGISTER (0x02h)

The charge pump clock register sets the charge pump frequency derived from MCLK when the LM49450 is in DAC mode. Default value is for register 02h is 0x49h.

**Table 6. Charge Pump Clock Register**

Bit	Name	Value								Description	
		B7	B6	B5	B4	B3	B2	B1	B0		
B7:B0	CPDIV_7(B7)									Sets charge pump oscillator frequency in DAC mode (derived from MCLK).  Bypass divider	
	CPDIV_6(B6)	0	0	0	0	0	0	0	0		
	CPDIV_5(B5)	0	0	0	0	0	0	0	1		
	CPDIV_4(B4)	0	0	0	0	0	0	1	0		
	CPDIV_3(B3)	0	0	0	0	0	1	0	0		
	CPDIV_2(B2)	0	0	0	0	0	1	0	1		
	CPDIV_1(B1)	TO									In 0.5 increments
	CPDIV_0(B0)	1	1	1	1	1	1	0	1		
		1	1	1	1	1	1	1	0		
		1	1	1	1	1	1	1	1		

### CP\_DIV REGISTER

#### LM49450 Clock Structure

This register is used to control the charge pump clock when the register field LINE\_IN\_ENABLE is low i.e. DAC mode. When the register field LINE\_IN\_ENABLE is high, the Clocks module is held in reset and as a result no CP\_CLOCK\_C is produced.

**Table 7. CP\_DIV Default Value 0x49h**

Bits	Field	Description	
7:0	CP_DIV	Programs the CP divider (divides from an expected 12.000MHz input).	
		CP_DIV	Divide Value
		0	Bypass
		1	1
		2	1.5
		3	2
		4	2.5
		5 to 253	3 to 127
		254	127.5
255	128		

Examples of CP\_DIV Values one might use for various sample rates and DAC modes

**Table 8. Typical CP\_DIV Values for DAC Mode 00**

MCLK (MHZ)	CP_DIV	Nominal Frequency (Hz)
2	11	333333
2.75625	16	324265
3	17	333333
4	23	333333
5.5125	33	324264
6	36	324324
8	48	326530
11.025	67	324265
12	73	324324

**Table 9. Typical CP\_DIV Values for DAC Mode 01**

MCLK (MHZ)	CP_DIV	Nominal Frequency (Hz)
2.048	11	341333
2.8224	17	313600
3.072	18	323368
4.096	24	327680
5.6448	33	332047
6.144	37	323368
8.192	49	327680
11.2896	68	327234
12.288	75	323368

**Table 10. Typical CP\_DIV Values for DAC Mode 10**

MCLK (MHZ)	CP_DIV	Nominal Frequency (Hz)
11.2896	68	327234
12.288	75	323368

**Table 11. Typical CP\_DIV Values for DAC Mode 11**

MCLK (MHZ)	CP_DIV	Nominal Frequency (Hz)
22.5792	138	324881
24.576	150	325510

**I<sup>2</sup>S MODE CONTROL REGISTER (0x03h)**

Default value is 0x00h.

**Table 12. I<sup>2</sup>S Mode Control Register**

Bit	Name	Value			Description
B7	RESERVED	X			Unused
B6:B4	I2S_WRD_2 (B6) I2S_WRD_1 (B5) I2S_WRD_0 (B5)	B6	B5	B4	Sets I <sup>2</sup> S word size in Right Justified Mode
		0	0	0	16
		0	0	1	18
		0	1	0	20
		0	1	1	22
		1	0	0	24
		1	0	1	25
		1	1	0	26
B3	I2S_STEREO_REVERSE	0			Normal mode. Left channel data goes to left channel output Right channel data goes to right channel output.
		1			Reverse mode. Left channel data goes to right channel output Right channel data goes to left channel output
B2	I2S_WORD_ORDER	0			Normal mode. I <sup>2</sup> S_WS = 0 indicates left channel audio I <sup>2</sup> S_WS = 1 indicates right channel audio
		1			Reverse mode. I <sup>2</sup> S_WS = 0 indicates right channel audio I <sup>2</sup> S_WS = 1 indicates left channel audio.
B1:B0	I2S_MODE_1 (B1) I2S_MODE_0 (B0)	B1	B0		Sets I <sup>2</sup> S operating mode
		0	0		Normal Mode
		0	1		Left Justified Mode
		1	0		Right Justified Mode
		1	1		Unused

## I<sup>2</sup>S CLOCK REGISTER (0x04h)

Default value is 0x00h.

**Table 13. I<sup>2</sup>S Clock Register**

Bit	Name	Value				Description	
B7:B4	I2S_CLK_3 (B7) I2S_CLK_2 (B6) I2S_CLK_1 (B5) I2S_CLK_0 (B4)	B7	B6	B5	B4	Sets divider ratio to derive the I <sup>2</sup> S clock from the divided MCLK in I <sup>2</sup> S master mode	
						DIVIDE BY	RATIO
		0	0	0	0	1	—
		0	0	0	1	2	—
		0	0	1	0	4	—
		0	1	1	1	6	—
		0	0	0	0	8	—
		0	0	1	1	10	—
		0	1	0	0	16	—
		0	1	1	1	20	—
		1	0	0	0	2.5	2.5
		1	0	0	1	3	1:3
		1	0	1	0	3.90625	32:125
		1	0	1	1	5	1:5
		1	1	0	0	7.8125	16:125
B3:B2	I2S_WS_1 (B3) I2S_WS_0 (B2)	B3		B2		Determines the bit length per data word of I <sup>2</sup> S_WS in I <sup>2</sup> S master mode	
		0	0			16	
		0	1			25	
		1	0			32	
		1	1			—	
B1	I2S_WS_M S	0				I <sup>2</sup> S WS slave mode. The LM49450 drives the I <sup>2</sup> S WS signal from the I2S_WS line.	
		1				I <sup>2</sup> S WS master mode. The LM49450 generates the I2S WS signal. I2S_WS line is driven by the LM49450	
B0	I2S_CLK_M S	0				I <sup>2</sup> S clock slave mode. The LM49450 derives its I <sup>2</sup> S clock from the I2S_CLK line.	
		1				I <sup>2</sup> S clock master mode. The LM49450 generates the I <sup>2</sup> S clock signal. I2S_CLK line is driven by the LM49450.	

## HEADPHONE 3D CONFIGURATION REGISTER (0x05h)

Default value is 0x00h.

**Table 14. Headphone 3D Configuration Register**

Bit	Name	Value	Description
B7	RESERVED	X	UNUSED
B6	HP_3DATTN	0	No Attenuation
		1	Output signals are attenuated by 6dB

**Table 14. Headphone 3D Configuration Register (continued)**

Bit	Name	Value		Description
B5:B4	HP_3DFREQ_1 (B5) HP_3DFREQ_0 (B4)	B5	B4	Sets 3D high pass filter -3dB (roll-off) frequency
		0	0	0
		0	1	300Hz
		1	0	600Hz
		1	1	900Hz
B3:B2	HP_3DFREQ_1 (B3) HP_3DFREQ_0 (B2)	B3	B2	Sets the 3D mix level, ie the amount of the left channel signal that appears on the right channel and visa versa.
		0	0	25%
		0	1	37.5%
		1	0	50%
		1	1	75%
B1	HP_3D	0		Narrow 3D effect
		1		Wide 3D effect
B0	HP_3DEN	0		Headphone 3D disabled
		1		Headphone 3D enabled

**LOUDSPEAKER 3D CONFIGURATION REGISTER (0x06h)**

Default value is 0x00h.

**Table 15. Loudspeaker 3D Configuration Register**

Bit	Name	Value		Description
B7	RESERVED	X		UNUSED
B6	LS_3DATTN	0		No Attenuation
		1		Output signals are attenuated by 6dB
B5:B4	LS_3DFREQ_1 (B5) LS_3DFREQ_0 (B4)	B5	B4	Sets 3D high pass filter -3dB (roll-off) frequency
		0	0	0
		0	1	300Hz
		1	0	600Hz
		1	1	900Hz
B3:B2	LS_3DFREQ_1 (B3) LS_3DFREQ_0 (B2)	B3	B2	Sets the 3D mix level, ie the amount of the left channel signal that appears on the right channel and visa versa.
		0	0	25%
		0	1	37.5%
		1	0	50%
		1	0	75%
B1	HP_3D	0		Narrow 3D effect
		1		Wide 3D effect
B0	HP_3DEN	0		Loudspeaker 3D disabled
		1		Loudspeaker 3D enabled

**HEADPHONE VOLUME CONTROL REGISTER (0x07h)**

Default value is 0x00h.

**Table 16. Headphone Volume Control Register**

Bit	Name	Value	Description
B7:B5	RESERVED	X	UNUSED
B4:B0	HP4 (B4) HP3 (B3) HP2 (B2) HP1 (B1) HP0 (B0)	See <a href="#">Headphone Volume Control Table</a>	Controls gain/attenuation of the audio signal in the headphone path.

VOLUME STEP	HP4	HP3	HP2	HP1	HP0	HP GAIN (dB)
1	0	0	0	0	0	-59
2	0	0	0	0	1	-48
3	0	0	0	1	0	-40.5
4	0	0	0	1	1	-34.5
5	0	0	1	0	0	-30
6	0	0	1	0	1	-27
7	0	0	1	1	0	-24
8	0	0	1	1	1	-21
9	0	1	0	0	0	-18
10	0	1	0	0	1	-15
11	0	1	0	1	0	-13.5
12	0	1	0	1	1	-12
13	0	1	1	0	0	-10.5
14	0	1	1	0	1	-9
15	0	1	1	1	0	-7.5
16	0	1	1	1	1	-6
17	1	0	0	0	0	-4.5
18	1	0	0	0	1	-3
19	1	0	0	1	0	-1.5
20	1	0	0	1	1	0
21	1	0	1	0	0	1.5
22	1	0	1	0	1	3
23	1	0	1	1	0	4.5
24	1	0	1	1	1	6
25	1	1	0	0	0	7.5
26	1	1	0	0	1	9
27	1	1	0	1	0	10.5
28	1	1	0	1	1	12
29	1	1	1	0	0	13.5
30	1	1	1	0	1	15
31	1	1	1	1	0	16.5
32	1	1	1	1	1	18

## LOUDSPEAKER VOLUME CONTROL REGISTER (0x08h)

Default value is 0x00h.

**Table 17. Loudspeaker Volume Control Register**

Bit	Name	Value	Description
B7:B5	RESERVED	X	UNUSED
B4:B0	LS4 (B4) LS3 (B3) LS2 (B2) LS1 (B1) LS0 (B0)	See <a href="#">Headphone Volume Control Table</a>	Controls gain/attenuation of the audio signal in the loudspeaker path.

VOLUME STEP	LS4	LS3	LS2	LS1	LS0	LS GAIN (dB)
1	0	0	0	0	0	-53
2	0	0	0	0	1	-42
3	0	0	0	1	0	-34.5
4	0	0	0	1	1	-28.5
5	0	0	1	0	0	-24
6	0	0	1	0	1	-21
7	0	0	1	1	0	-18
8	0	0	1	1	1	-15
9	0	1	0	0	0	-12
10	0	1	0	0	1	-9
11	0	1	0	1	0	-7.5
12	0	1	0	1	1	-6
13	0	1	1	0	0	-4.5
14	0	1	1	0	1	-3
15	0	1	1	1	0	-1.5
16	0	1	1	1	1	0
17	1	0	0	0	0	1.5
18	1	0	0	0	1	3
19	1	0	0	1	0	4.5
20	1	0	0	1	1	6
21	1	0	1	0	0	7.5
22	1	0	1	0	1	9
23	1	0	1	1	0	10.5
24	1	0	1	1	1	12
25	1	1	0	0	0	13.5
26	1	1	0	0	1	15
27	1	1	0	1	0	16.5
28	1	1	0	1	1	18
29	1	1	1	0	0	19.5
30	1	1	1	0	1	21
31	1	1	1	1	0	22.5
32	1	1	1	1	1	24

## DAC COMPENSATION FILTER REGISTERS (0x09h to 0x0Eh)

### *DAC Compensation Filter*

The LM49450 DAC features a 5 band FIR filter that can be used as an equalizer for the digital audio path. Registers 0x09h, 0x0Ah, 0x0Bh, 0x0Ch, 0x0Dh, and 0x0Eh provide an 8-bit control for each individual FIR filter.

## EXTERNAL COMPONENT SELECTION

The LM49450 uses different supplies for each portion of the device, allowing for the optimum combination of headroom, power dissipation and noise immunity. The speaker amplifier gain stage is powered from  $V_{DD}$ , while the output stage is powered from  $LSV_{DD}$ . The headphone amplifiers, input amplifiers and volume control stages are powered from  $HPV_{DD}$ . The separate power supplies allow the speakers to operate from a higher voltage for maximum headroom, while the headphones operate from a lower voltage, improving power dissipation.  $HPV_{DD}$  may be driven by a linear regulator to further improve performance in noisy environments. The I<sup>2</sup>C portion is powered from  $I^2CV_{DD}$ , allowing the I<sup>2</sup>C portion of the LM49450 to interface with lower voltage digital controllers.

## PROPER SELECTION OF EXTERNAL COMPONENTS

### *Power Supply Bypassing and Filtering*

Proper power supply bypassing is critical for low noise performance and high PSRR. Place the supply bypass capacitors as close to the device as possible. Typical applications employ a voltage regulator with 10 $\mu$ F and 0.1 $\mu$ F bypass capacitors that increase supply stability. These capacitors do not eliminate the need for bypassing of the LM49450 supply pins. A 1 $\mu$ F ceramic capacitor placed close to each supply pin is recommended.

### *Bypass Capacitor Selection*

The LM49450 internally generates a  $V_{DD}/2$  common-mode bias voltage. The BYPASS capacitor CBYPASS, improves PSRR and THD+N by reducing noise at the BYPASS node. Use a 2.2 $\mu$ F ceramic placed as close to the device as possible.

### *REF Capacitor Selection*

The LM49450 generates an internal low noise reference voltage used by the DAC. For best THD+N performance, bypass REF with 10 $\mu$ F and 0.1 $\mu$ F ceramic capacitors.

### *Charge Pump Capacitor Selection*

Use low ESR ceramic capacitors (less than 100m $\Omega$ ) for optimum performance.

### *Charge Pump Flying Capacitor (C1)*

The flying capacitor (C1) affects the load regulation and output impedance of the charge pump. A C1 value that is too low results in a loss of current drive, leading to a loss of amplifier headroom. A higher valued C1 improves load regulation and lowers charge pump output impedance to an extent. Above 2.2 $\mu$ F, the  $R_{DS(ON)}$  of the charge pump switches and the ESR of C1 and C2 dominate the output impedance. A lower value capacitor can be used in systems where low maximum output power requirements.

### *Charge Pump Hold Capacitor (C2)*

The value and ESR of the hold capacitor (C2) directly affects the ripple on  $CPV_{SS}$ . Increasing the value of C2 reduces output ripple. Decreasing the ESR of C2 reduces both output ripple and charge pump output impedance. A lower value capacitor can be used in systems where low maximum output power requirements.

### *Input Capacitor Selection*

The LM49450 analog inputs require input coupling capacitors. Input capacitors block the DC component of the audio signal, eliminating any conflict between the DC component of the audio source and the bias voltage of the LM49450. The input capacitors create a high-pass filter with the input resistors  $R_{IN}$ . The -3dB point of the high pass filter is found using [Equation 1](#) below.

$$f = 1 / 2\pi R_{IN} C_{IN}$$

where

- the value of  $R_{IN}$  is typically 20k $\Omega$  (1)

The input capacitors can also be used to remove low frequency content from the audio signal. Small speakers cannot reproduce, and may even be damaged by low frequencies. High pass filtering the audio signal helps protect the speakers. When the LM49450 is using a single-ended source, power supply noise on the ground is seen as an input signal. Setting the high-pass filter point above the power supply noise frequencies, 217Hz in a GSM phone, for example, filters out the noise such that it is not amplified and heard on the output. Capacitors with a tolerance of 10% or better are recommended for impedance matching and improved CMRR and PSRR.

## PCB Layout Guidelines

Minimize trace impedance of the power, ground and all output traces for optimum performance. Voltage loss due to trace resistance between the LM49450 and the load results in decreased output power and efficiency. Trace resistance between the power supply and ground has the same effect as a poorly regulated supply, increased ripple and reduced peak output power. Use wide traces for power supply inputs and amplifier outputs to minimize losses due to trace resistance, as well as route heat away from the device. Proper grounding improves audio performance, minimizes crosstalk between channels and prevents switching noise from interfering with the audio signal. Use of power and ground planes is recommended.

Place all digital components and route digital signal traces as far as possible from analog components and traces. Do not run digital and analog traces in parallel on the same PCB layer. If digital and analog signal lines must cross either over or under each other, ensure that they cross in a perpendicular fashion.

## Exposed DAP Mounting Considerations

The LM49450 WQFN package features an exposed die-attach (thermal) pad on its backside. The exposed pad provides a direct heat conduction path from the die to the PCB, reducing the thermal resistance of the package. Connect the exposed pad to GND with a large pad and via to a large GND plane on the bottom of the PCB for best heat distribution.

## Revision Table

Rev	Date	Description
1.0	12/18/07	Initial release.
1.01	09/26/08	Corrected the package drawing.
1.02	08/04/11	On <a href="#">Table 5</a> (Common DAC Clock..., col DAC MODE = 2b01... sample 8...), changed 2.084 to 2.048.
D	05/03/13	Changed layout of National Data Sheet to TI format.

**PACKAGING INFORMATION**

Orderable Device	Status (1)	Package Type	Package Drawing	Pins	Package Qty	Eco Plan (2)	Lead/Ball Finish	MSL Peak Temp (3)	Op Temp (°C)	Top-Side Markings (4)	Samples
LM49450SQ/NOPB	ACTIVE	WQFN	RTV	32	1000	Green (RoHS & no Sb/Br)	CU SN	Level-1-260C-UNLIM	-40 to 85	L49450	<a href="#">Samples</a>
LM49450SQX/NOPB	ACTIVE	WQFN	RTV	32	4500	Green (RoHS & no Sb/Br)	CU SN	Level-1-260C-UNLIM	-40 to 85	L49450	<a href="#">Samples</a>

(1) The marketing status values are defined as follows:

**ACTIVE:** Product device recommended for new designs.

**LIFEBUY:** TI has announced that the device will be discontinued, and a lifetime-buy period is in effect.

**NRND:** Not recommended for new designs. Device is in production to support existing customers, but TI does not recommend using this part in a new design.

**PREVIEW:** Device has been announced but is not in production. Samples may or may not be available.

**OBSOLETE:** TI has discontinued the production of the device.

(2) Eco Plan - The planned eco-friendly classification: Pb-Free (RoHS), Pb-Free (RoHS Exempt), or Green (RoHS & no Sb/Br) - please check <http://www.ti.com/productcontent> for the latest availability information and additional product content details.

**TBD:** The Pb-Free/Green conversion plan has not been defined.

**Pb-Free (RoHS):** TI's terms "Lead-Free" or "Pb-Free" mean semiconductor products that are compatible with the current RoHS requirements for all 6 substances, including the requirement that lead not exceed 0.1% by weight in homogeneous materials. Where designed to be soldered at high temperatures, TI Pb-Free products are suitable for use in specified lead-free processes.

**Pb-Free (RoHS Exempt):** This component has a RoHS exemption for either 1) lead-based flip-chip solder bumps used between the die and package, or 2) lead-based die adhesive used between the die and leadframe. The component is otherwise considered Pb-Free (RoHS compatible) as defined above.

**Green (RoHS & no Sb/Br):** TI defines "Green" to mean Pb-Free (RoHS compatible), and free of Bromine (Br) and Antimony (Sb) based flame retardants (Br or Sb do not exceed 0.1% by weight in homogeneous material)

(3) MSL, Peak Temp. -- The Moisture Sensitivity Level rating according to the JEDEC industry standard classifications, and peak solder temperature.

(4) Multiple Top-Side Markings will be inside parentheses. Only one Top-Side Marking contained in parentheses and separated by a "~" will appear on a device. If a line is indented then it is a continuation of the previous line and the two combined represent the entire Top-Side Marking for that device.

**Important Information and Disclaimer:** The information provided on this page represents TI's knowledge and belief as of the date that it is provided. TI bases its knowledge and belief on information provided by third parties, and makes no representation or warranty as to the accuracy of such information. Efforts are underway to better integrate information from third parties. TI has taken and continues to take reasonable steps to provide representative and accurate information but may not have conducted destructive testing or chemical analysis on incoming materials and chemicals. TI and TI suppliers consider certain information to be proprietary, and thus CAS numbers and other limited information may not be available for release.

In no event shall TI's liability arising out of such information exceed the total purchase price of the TI part(s) at issue in this document sold by TI to Customer on an annual basis.

**TAPE AND REEL INFORMATION**

**QUADRANT ASSIGNMENTS FOR PIN 1 ORIENTATION IN TAPE**

\*All dimensions are nominal

Device	Package Type	Package Drawing	Pins	SPQ	Reel Diameter (mm)	Reel Width W1 (mm)	A0 (mm)	B0 (mm)	K0 (mm)	P1 (mm)	W (mm)	Pin1 Quadrant
LM49450SQ/NOPB	WQFN	RTV	32	1000	178.0	12.4	5.3	5.3	1.3	8.0	12.0	Q1
LM49450SQX/NOPB	WQFN	RTV	32	4500	330.0	12.4	5.3	5.3	1.3	8.0	12.0	Q1

TAPE AND REEL BOX DIMENSIONS



\*All dimensions are nominal

Device	Package Type	Package Drawing	Pins	SPQ	Length (mm)	Width (mm)	Height (mm)
LM49450SQ/NOPB	WQFN	RTV	32	1000	210.0	185.0	35.0
LM49450SQX/NOPB	WQFN	RTV	32	4500	367.0	367.0	35.0

RTV0032A

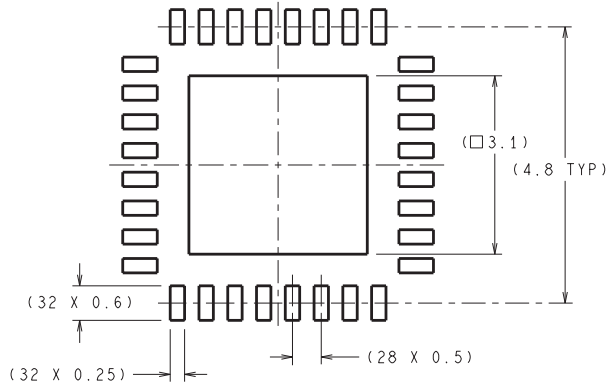

DIMENSIONS ARE IN MILLIMETERS  
DIMENSIONS IN ( ) FOR REFERENCE ONLY



RECOMMENDED LAND PATTERN

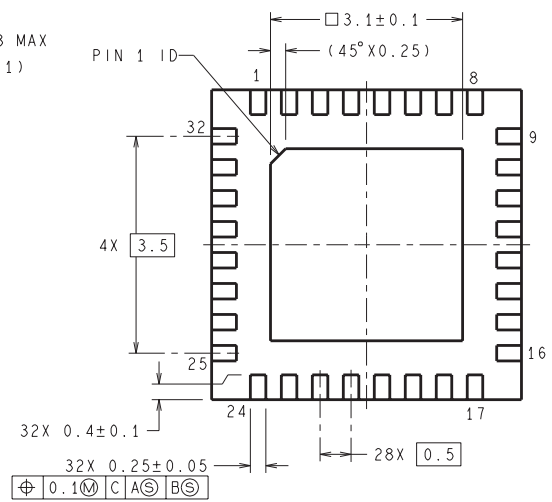
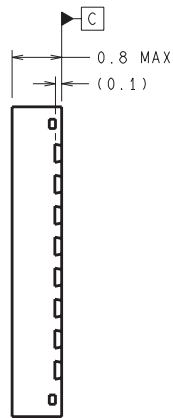
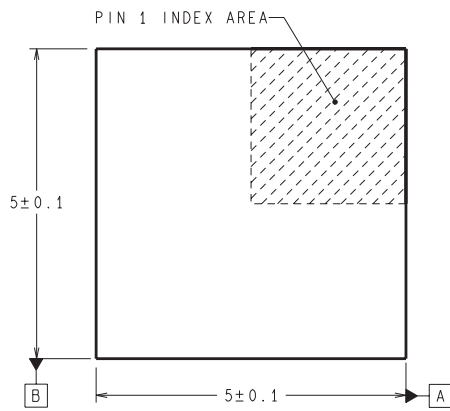

SQA32A (Rev B)

## IMPORTANT NOTICE

Texas Instruments Incorporated and its subsidiaries (TI) reserve the right to make corrections, enhancements, improvements and other changes to its semiconductor products and services per JESD46, latest issue, and to discontinue any product or service per JESD48, latest issue. Buyers should obtain the latest relevant information before placing orders and should verify that such information is current and complete. All semiconductor products (also referred to herein as "components") are sold subject to TI's terms and conditions of sale supplied at the time of order acknowledgment.

TI warrants performance of its components to the specifications applicable at the time of sale, in accordance with the warranty in TI's terms and conditions of sale of semiconductor products. Testing and other quality control techniques are used to the extent TI deems necessary to support this warranty. Except where mandated by applicable law, testing of all parameters of each component is not necessarily performed.

TI assumes no liability for applications assistance or the design of Buyers' products. Buyers are responsible for their products and applications using TI components. To minimize the risks associated with Buyers' products and applications, Buyers should provide adequate design and operating safeguards.

TI does not warrant or represent that any license, either express or implied, is granted under any patent right, copyright, mask work right, or other intellectual property right relating to any combination, machine, or process in which TI components or services are used. Information published by TI regarding third-party products or services does not constitute a license to use such products or services or a warranty or endorsement thereof. Use of such information may require a license from a third party under the patents or other intellectual property of the third party, or a license from TI under the patents or other intellectual property of TI.

Reproduction of significant portions of TI information in TI data books or data sheets is permissible only if reproduction is without alteration and is accompanied by all associated warranties, conditions, limitations, and notices. TI is not responsible or liable for such altered documentation. Information of third parties may be subject to additional restrictions.

Resale of TI components or services with statements different from or beyond the parameters stated by TI for that component or service voids all express and any implied warranties for the associated TI component or service and is an unfair and deceptive business practice. TI is not responsible or liable for any such statements.

Buyer acknowledges and agrees that it is solely responsible for compliance with all legal, regulatory and safety-related requirements concerning its products, and any use of TI components in its applications, notwithstanding any applications-related information or support that may be provided by TI. Buyer represents and agrees that it has all the necessary expertise to create and implement safeguards which anticipate dangerous consequences of failures, monitor failures and their consequences, lessen the likelihood of failures that might cause harm and take appropriate remedial actions. Buyer will fully indemnify TI and its representatives against any damages arising out of the use of any TI components in safety-critical applications.

In some cases, TI components may be promoted specifically to facilitate safety-related applications. With such components, TI's goal is to help enable customers to design and create their own end-product solutions that meet applicable functional safety standards and requirements. Nonetheless, such components are subject to these terms.

No TI components are authorized for use in FDA Class III (or similar life-critical medical equipment) unless authorized officers of the parties have executed a special agreement specifically governing such use.

Only those TI components which TI has specifically designated as military grade or "enhanced plastic" are designed and intended for use in military/aerospace applications or environments. Buyer acknowledges and agrees that any military or aerospace use of TI components which have **not** been so designated is solely at the Buyer's risk, and that Buyer is solely responsible for compliance with all legal and regulatory requirements in connection with such use.

TI has specifically designated certain components as meeting ISO/TS16949 requirements, mainly for automotive use. In any case of use of non-designated products, TI will not be responsible for any failure to meet ISO/TS16949.

### Products

Audio	<a href="http://www.ti.com/audio">www.ti.com/audio</a>
Amplifiers	<a href="http://amplifier.ti.com">amplifier.ti.com</a>
Data Converters	<a href="http://dataconverter.ti.com">dataconverter.ti.com</a>
DLP® Products	<a href="http://www.dlp.com">www.dlp.com</a>
DSP	<a href="http://dsp.ti.com">dsp.ti.com</a>
Clocks and Timers	<a href="http://www.ti.com/clocks">www.ti.com/clocks</a>
Interface	<a href="http://interface.ti.com">interface.ti.com</a>
Logic	<a href="http://logic.ti.com">logic.ti.com</a>
Power Mgmt	<a href="http://power.ti.com">power.ti.com</a>
Microcontrollers	<a href="http://microcontroller.ti.com">microcontroller.ti.com</a>
RFID	<a href="http://www.ti-rfid.com">www.ti-rfid.com</a>
OMAP Applications Processors	<a href="http://www.ti.com/omap">www.ti.com/omap</a>
Wireless Connectivity	<a href="http://www.ti.com/wirelessconnectivity">www.ti.com/wirelessconnectivity</a>

### Applications

Automotive and Transportation	<a href="http://www.ti.com/automotive">www.ti.com/automotive</a>
Communications and Telecom	<a href="http://www.ti.com/communications">www.ti.com/communications</a>
Computers and Peripherals	<a href="http://www.ti.com/computers">www.ti.com/computers</a>
Consumer Electronics	<a href="http://www.ti.com/consumer-apps">www.ti.com/consumer-apps</a>
Energy and Lighting	<a href="http://www.ti.com/energy">www.ti.com/energy</a>
Industrial	<a href="http://www.ti.com/industrial">www.ti.com/industrial</a>
Medical	<a href="http://www.ti.com/medical">www.ti.com/medical</a>
Security	<a href="http://www.ti.com/security">www.ti.com/security</a>
Space, Avionics and Defense	<a href="http://www.ti.com/space-avionics-defense">www.ti.com/space-avionics-defense</a>
Video and Imaging	<a href="http://www.ti.com/video">www.ti.com/video</a>

### TI E2E Community

[e2e.ti.com](http://e2e.ti.com)

# AMEYA360

## Components Supply Platform

Authorized Distribution Brand :



Website :

Welcome to visit [www.ameya360.com](http://www.ameya360.com)

Contact Us :

➤ Address :

401 Building No.5, JiuGe Business Center, Lane 2301, Yishan Rd  
Minhang District, Shanghai , China

➤ Sales :

Direct +86 (21) 6401-6692

Email [amall@ameya360.com](mailto:amall@ameya360.com)

QQ 800077892

Skype [ameyasales1](#) [ameyasales2](#)

➤ Customer Service :

Email [service@ameya360.com](mailto:service@ameya360.com)

➤ Partnership :

Tel +86 (21) 64016692-8333

Email [mkt@ameya360.com](mailto:mkt@ameya360.com)