

DATE	DESCRIPTION	REV.
2.25.10	CHANGE AS PER ECN 10-017	A
6.01.11	CHANGE AS PER ECN 11-077	B
11.05.12	CHANGE AS PER ECN 12-155	C
2.20.13	CHANGE AS PER ECN 13-019	D

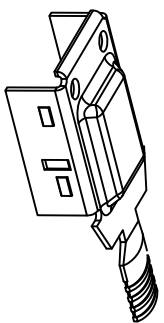

Top Shell

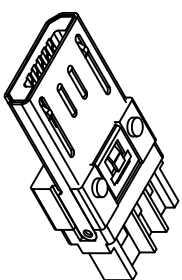
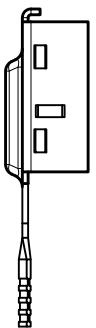
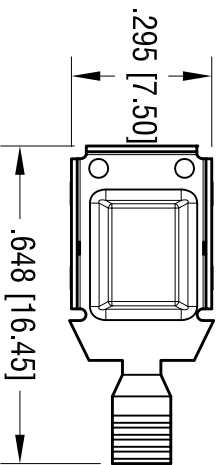

Insulator Body

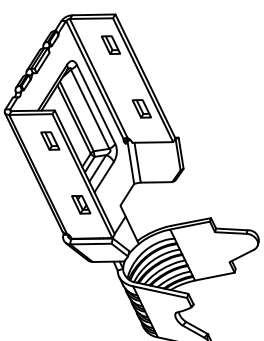
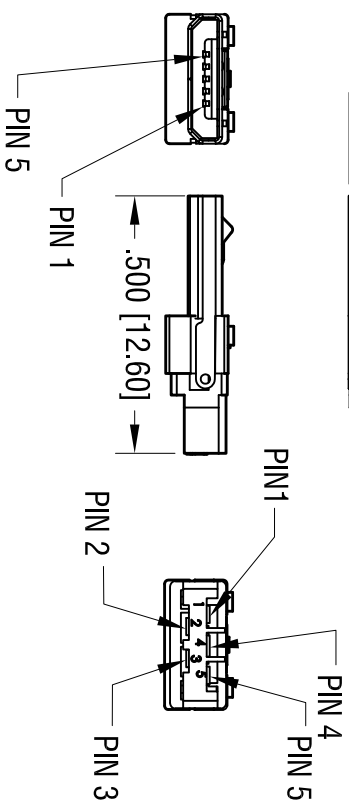
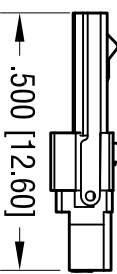
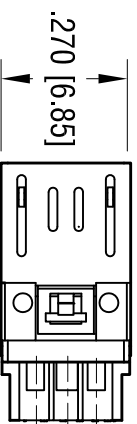

Bottom Shell

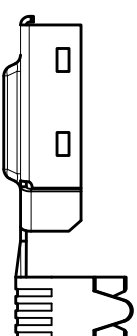
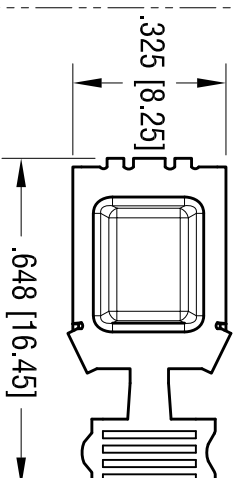

Supplied Unassembled

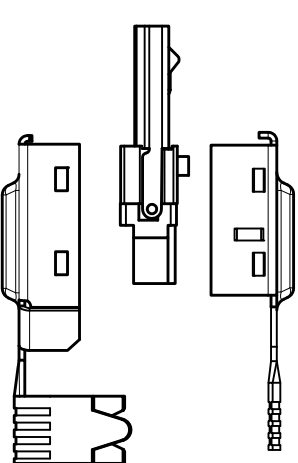

Notes:

Material:

- Shell: Steel, Nickel Plate.
- Insulator: PBT, UL 94-V0 (Color Black)
- Contacts: Phosphor Bronze
- Finish:
- Contact Area: Gold Plate over Nickel Plate
- on Solder Tail: Tin Plate over Nickel Plate

Electrical Specifications

- Rated Voltage: 30V AC (rms)
- Contact Current Rating: 1.5 Amp
- Contact Resistance: 30 milliohms Max.
- Dielectric Withstanding: 100V AC
- Operating Temperature: -30°C to 85°C

ACTUAL SIZE

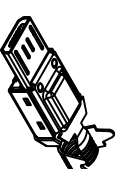

THIS DOCUMENT IS THE PROPERTY OF KEYSTONE ELECTRONICS CORP. AND SHALL NOT BE REPRODUCED, DISTRIBUTED OR USED AS A BASIS FOR MANUFACTURE WITHOUT PRIOR WRITTEN PERMISSION FROM KEYSTONE ELECTRONICS CORP.

KEYSTONE ELECTRONICS CORP.			
www.keystec.com • ASTORIA, N.Y. 11105-2017 • Tel (718) 956-8900			
PART NAME		MICRO USB PLUG	
MATERIAL		AS NOTED	
FINISH	AS NOTED	DRN BY	DATE
		NT	11.23.09
TOLERANCES	INCH [MM]	CODE	DWG NO.
DECIMAL	± .010 [± 0.25]	C	941
ANGULAR	± 1°		
UNLESS OTHERWISE SPECIFIED			
App'D	LN	SCALE	2.5X

AMEYA360

Components Supply Platform

Authorized Distribution Brand :



Website :

Welcome to visit www.ameya360.com

Contact Us :

➤ Address :

401 Building No.5, JiuGe Business Center, Lane 2301, Yishan Rd
Minhang District, Shanghai , China

➤ Sales :

Direct +86 (21) 6401-6692

Email amall@ameya360.com

QQ 800077892

Skype [ameyasales1](#) [ameyasales2](#)

➤ Customer Service :

Email service@ameya360.com

➤ Partnership :

Tel +86 (21) 64016692-8333

Email mkt@ameya360.com