

## 10 + 10 W stereo amplifier for car radio

### Features

- Low distortion
- Low noise
- Protection against:
  - Output AC short circuit to ground
  - Overrating chip temperature
  - Load dump voltage surge
  - Fortuitous open ground
  - Very inductive loads

### Description

The TDA2004R is a class B dual audio power amplifier in Multiwatt11 package specifically designed for car radio applications.

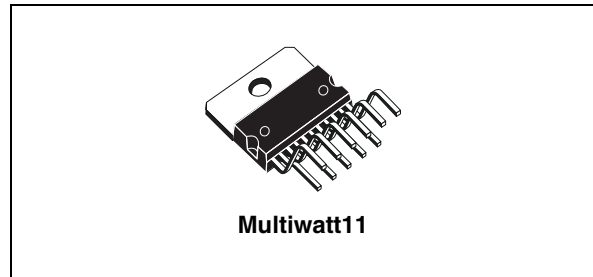

Power booster amplifiers can be easily designed using this device that provides a high current capability (up to 3.5 A) and can drive very low impedance loads (down to 1.6  $\Omega$ ).

The TDA2004R allows very compact applications because few external components are required and it doesn't need electrical insulation between the package and the heatsink.

**Table 1. Device summary**

Order code	Package	Packing
TDA2004R	Multiwatt11	Tube

# Contents

- 1 Pins description ..... 5**
- 2 Electrical specifications ..... 6**
  - 2.1 Absolute maximum ratings ..... 6
  - 2.2 Thermal data ..... 6
  - 2.3 Electrical characteristics ..... 6
  - 2.4 Test and application circuit ..... 8
  - 2.5 Electrical characteristics curves ..... 9
- 3 Application suggestion ..... 12**
  - 3.1 Built-in protection systems ..... 12
    - 3.1.1 Load dump voltage surge ..... 12
    - 3.1.2 Short circuit (AC condition) ..... 13
    - 3.1.3 Polarity inversion ..... 13
    - 3.1.4 Open ground ..... 13
    - 3.1.5 Inductive load ..... 13
    - 3.1.6 DC voltage ..... 13
    - 3.1.7 Thermal shut-down ..... 14
- 4 Package information ..... 15**
- 5 Revision history ..... 16**

## List of tables

Table 1.	Device summary . . . . .	1
Table 2.	Absolute maximum ratings . . . . .	6
Table 3.	Thermal data . . . . .	6
Table 4.	Electrical characteristics . . . . .	6
Table 5.	Recommended values of the component of the application circuit. . . . .	12
Table 6.	Document revision history . . . . .	16

## List of figures

Figure 1.	Pins connection diagram (top view) . . . . .	5
Figure 2.	Test and application circuit . . . . .	8
Figure 3.	Printed circuit board and components layout of the figure 2. . . . .	8
Figure 4.	Quiescent output voltage vs. supply voltage . . . . .	9
Figure 5.	Quiescent drain current vs. supply voltage . . . . .	9
Figure 6.	Distortion vs. output power . . . . .	9
Figure 7.	Output power vs. supply voltage, $R_L = 2$ and $4 \Omega$ . . . . .	9
Figure 8.	Output power vs. supply voltage, $R_L = 1.6$ and $3.2 \Omega$ . . . . .	9
Figure 9.	Distortion vs. frequency, $R_L = 2$ and $4 \Omega$ . . . . .	9
Figure 10.	Distortion vs. frequency, $R_L = 1.6$ and $3.2 \Omega$ . . . . .	10
Figure 11.	Supply voltage rejection vs. C3 . . . . .	10
Figure 12.	Supply voltage rejection vs. frequency . . . . .	10
Figure 13.	Supply voltage rejection vs. C2 and C3, $G_V = 390/1 \Omega$ . . . . .	10
Figure 14.	Supply voltage rejection vs. C2 and C3, $G_V = 1000/10 \Omega$ . . . . .	10
Figure 15.	Gain vs. input sensitivity . . . . .	10
Figure 16.	Total power dissipation and efficiency vs. output power ( $R_L = 2 \Omega$ ) . . . . .	11
Figure 17.	Total power dissipation and efficiency vs. output power ( $R_L = 3.2 \Omega$ ) . . . . .	11
Figure 18.	Maximum allowable power dissipation vs. ambient temperature . . . . .	11
Figure 19.	Suggested LC network circuit . . . . .	13
Figure 20.	Voltage gain bridge configuration . . . . .	13
Figure 21.	Multiwatt11 mechanical data and package dimensions . . . . .	15

# 1 Pins description

Figure 1. Pins connection diagram (top view)

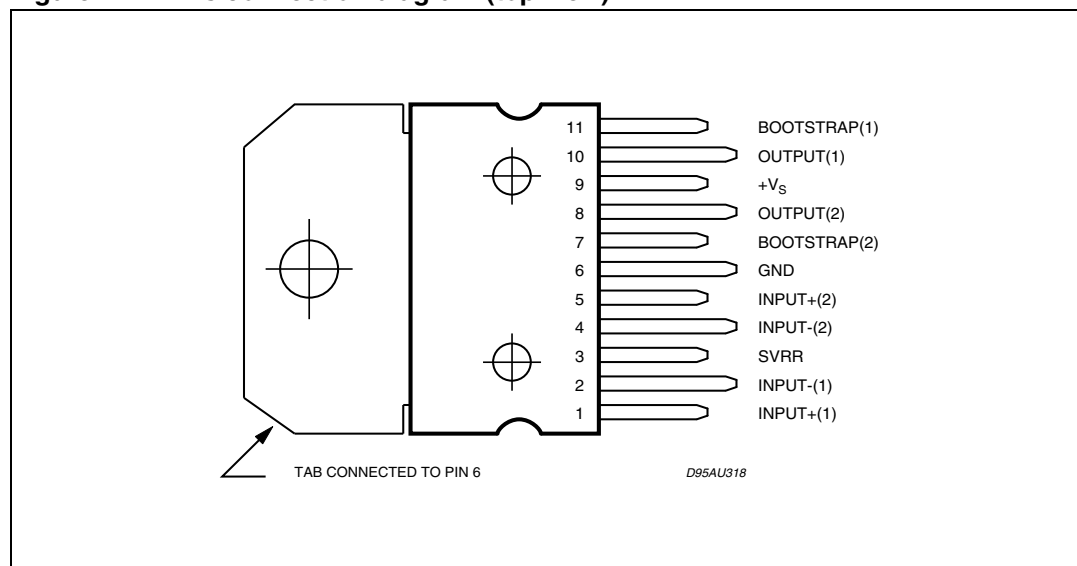

## 2 Electrical specifications

### 2.1 Absolute maximum ratings

Table 2. Absolute maximum ratings

Symbol	Parameter	Value	Unit
$V_S$	Operating supply voltage	18	V
	DC supply voltage	28	
	Peak supply voltage (50 ms)	40	
$I_{O(1)}$	Output peak current (non repetitive t = 0.1 ms)	4.5	A
	Output peak current (repetitive f $\geq$ 10 Hz)	3.5	
$P_{tot}$	Power dissipation at $T_{case} = 60\text{ }^\circ\text{C}$	30	W
$T_{stg}, T_j$	Storage and junction temperature	-40 to 150	$^\circ\text{C}$

1. The max. output current is internally limited.

### 2.2 Thermal data

Table 3. Thermal data

Symbol	Parameter	Value	Unit
$R_{th-j-case}$	Thermal resistance junction-to-case	max 3	$^\circ\text{C}/\text{W}$

### 2.3 Electrical characteristics

Refer to the stereo application circuit  $T_{amb} = 25\text{ }^\circ\text{C}$ ;  $G_v = 50\text{ dB}$ ;  $R_{th(heatsink)} = 4\text{ }^\circ\text{C}/\text{W}$  unless otherwise specified

Table 4. Electrical characteristics

Symbol	Parameter	Test condition	Min.	Typ.	Max.	Unit
$V_S$	Supply voltage		8		18	V
$V_o$	Quiescent offset voltage	$V_S = 14.4\text{ V}$	6.6	7.2	7.8	V
		$V_S = 13.2\text{ V}$	6	6.6	7.2	V
$I_d$	Total quiescent drain current	$V_S = 14.4\text{ V}$	-	65	120	mA
		$V_S = 13.2\text{ V}$		62	120	mA
$P_o$	Output power (each channel)	f = 1 kHz; THD = 10 %				
		$V_S = 14.4\text{ V}$ ; $R_L = 4\ \Omega$	6	6.5		W
		$V_S = 14.4\text{ V}$ ; $R_L = 3.2\ \Omega$	7	8	-	
		$V_S = 14.4\text{ V}$ ; $R_L = 2\ \Omega$	9	10		
	$V_S = 14.4\text{ V}$ ; $R_L = 1.6\ \Omega$	10	11			

Table 4. Electrical characteristics (continued)

Symbol	Parameter	Test condition	Min.	Typ.	Max.	Unit
$P_o$	Output power (each channel)	$f = 1 \text{ kHz}$ ; THD = 10 % $V_S = 13.2 \text{ V}$ ; $R_L = 3.2 \Omega$ $V_S = 13.2 \text{ V}$ ; $R_L = 1.6 \Omega$ $V_S = 16 \text{ V}$ ; $R_L = 2 \Omega$	6 9	6.5 10 <sup>(1)</sup> 12	-	W
THD	Total harmonic distortion	$f = 1 \text{ kHz}$ ; $V_S = 14.4 \text{ V}$ ; $R_L = 4 \Omega$ ; $P_o = 50 \text{ mW}$ to $4 \text{ W}$ ;	-	0.2	1	%
		$f = 1 \text{ kHz}$ ; $V_S = 14.4 \text{ V}$ ; $R_L = 2 \Omega$ ; $P_o = 50 \text{ mW}$ to $6 \text{ W}$ ;	-	0.3	1	%
		$f = 1 \text{ kHz}$ ; $V_S = 13.2 \text{ V}$ ; $R_L = 3.2 \Omega$ ; $P_o = 50 \text{ mW}$ to $3 \text{ W}$ ;	-	0.2	1	%
		$f = 1 \text{ kHz}$ ; $V_S = 13.2 \text{ V}$ ; $R_L = 1.6 \Omega$ ; $P_o = 40 \text{ mW}$ to $6 \text{ W}$ ;	-	0.3	1	%
CT	Cross talk	$V_S = 14.4 \text{ V}$ ; $V_o = 4 \text{ V}_{\text{RMS}}$ ; $R_g = 5 \text{ k}\Omega$ ; $R_L = 4 \Omega$ ; $f = 1 \text{ kHz}$	50 40	60 45	-	mW mW
		$f = 10 \text{ kHz}$				
$V_i$	Input saturation voltage	-	300		-	mW
$R_i$	Input resistance	$f = 1 \text{ kHz}$	70	200	-	k $\Omega$
$f_L$	Low frequency roll off (-3 dB)	$R_L = 4 \Omega$ $R_L = 2 \Omega$ $R_L = 3.2 \Omega$ $R_L = 1.6 \Omega$	-	-	35 50 40 55	Hz
$f_H$	High frequency roll off (-3 dB)	$R_L = 1.6 \Omega$ to $4 \Omega$	15	-	-	kHz
$G_v$	Open loop voltage gain	$f = 1 \text{ kHz}$	-	90	-	dB
	Closed loop voltage gain	$f = 1 \text{ kHz}$	48	50	51	
$\Delta G_v$	Closed loop gain matching	-	-	0.5	-	dB
$e_N$	Total input noise voltage	$R_g = 10 \text{ k}\Omega$ <sup>(2)</sup>	-	1.5	5	$\mu\text{V}$
SVR	Supply voltage rejection	$V_{\text{ripple}} = 0.5 \text{ V}_{\text{rms}}$ ; $f_{\text{ripple}} = 100 \text{ Hz}$ ; $R_g = 10 \text{ k}\Omega$ ; $C_3 = 10 \mu\text{F}$	35	45	-	dB
$\eta$	Efficiency	$f = 1 \text{ kHz}$ ; $V_S = 14.4 \text{ V}$ ; $R_L = 4 \Omega$ ; $P_o = 6.5 \text{ W}$ ; $R_L = 2 \Omega$ ; $P_o = 10 \text{ W}$ ;	-	70 60	-	%
		$f = 1 \text{ kHz}$ ; $V_S = 13.2 \text{ V}$ ; $R_L = 3.2 \Omega$ ; $P_o = 6.5 \text{ W}$ ; $R_L = 1.6 \Omega$ ; $P_o = 10 \text{ W}$ ;	-	70 60	-	%
$T_J$	Thermal shutdown junction temperature	-	-	145	-	$^{\circ}\text{C}$

1. 9.3 W without bootstrap.

2. Bandwidth filter: 22 Hz to 22 kHz.

## 2.4 Test and application circuit

Figure 2. Test and application circuit

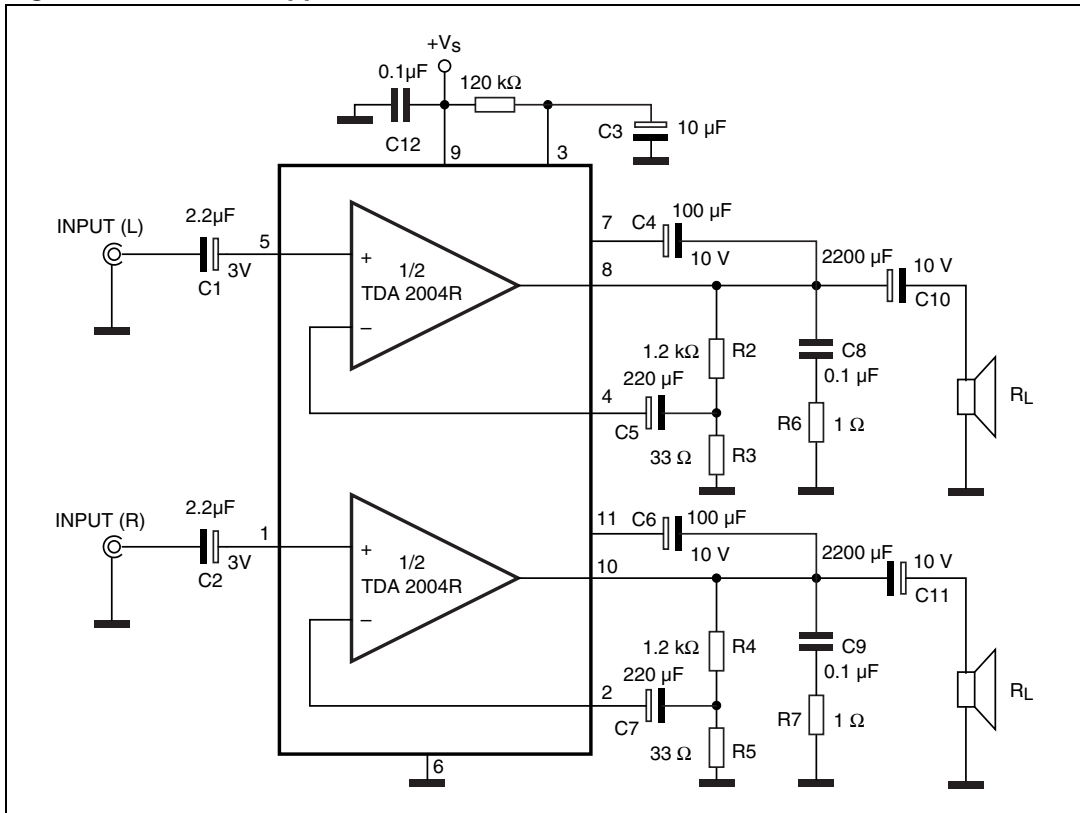
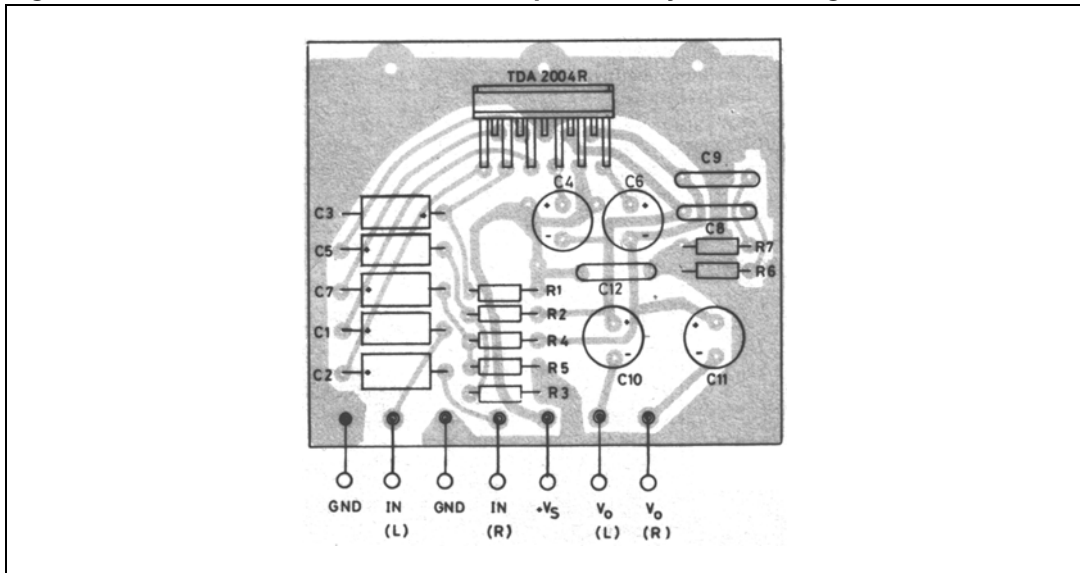

Figure 3. Printed circuit board and components layout of the figure 2





## 2.5 Electrical characteristics curves

Figure 4. Quiescent output voltage vs. supply voltage

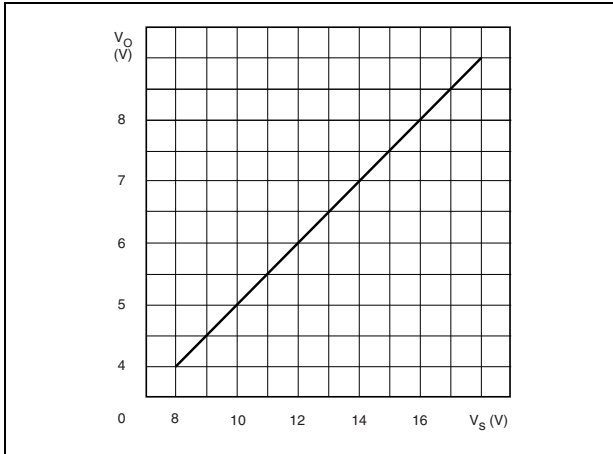

Figure 6. Distortion vs. output power

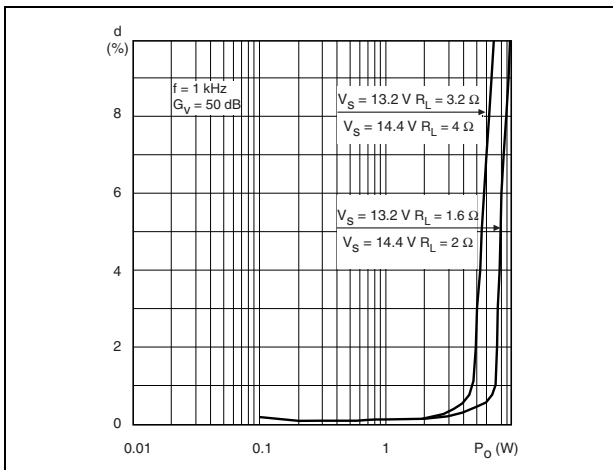

Figure 8. Output power vs. supply voltage,  $R_L = 1.6$  and  $3.2 \Omega$

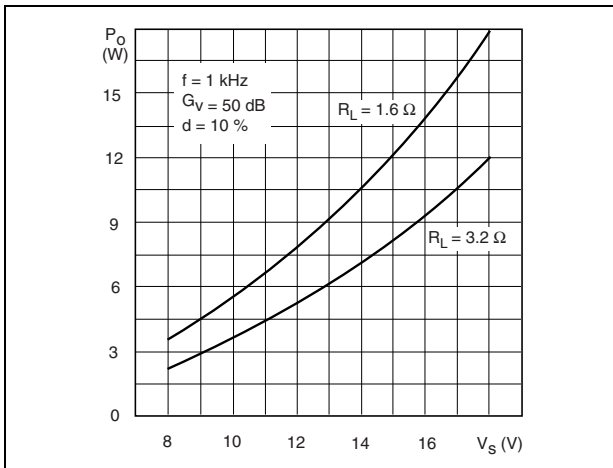

Figure 5. Quiescent drain current vs. supply voltage

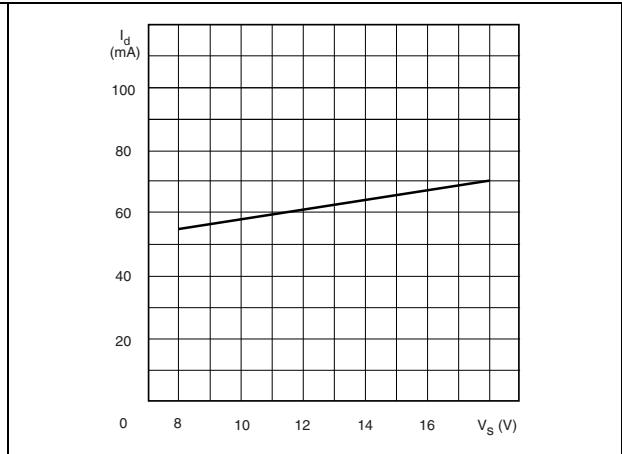

Figure 7. Output power vs. supply voltage,  $R_L = 2$  and  $4 \Omega$

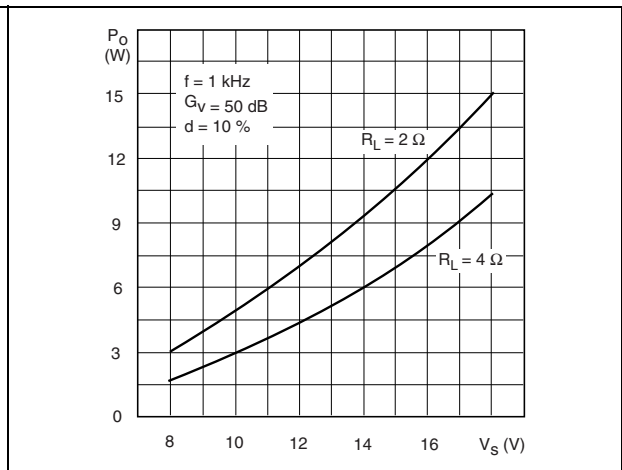

Figure 9. Distortion vs. frequency,  $R_L = 2$  and  $4 \Omega$

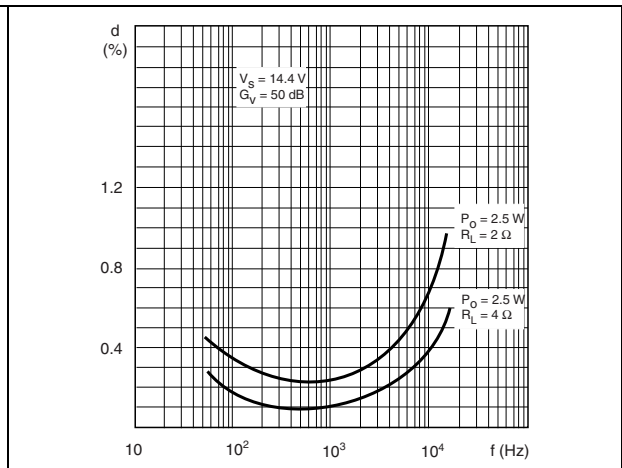

Figure 10. Distortion vs. frequency,  $R_L = 1.6$  and  $3.2 \Omega$

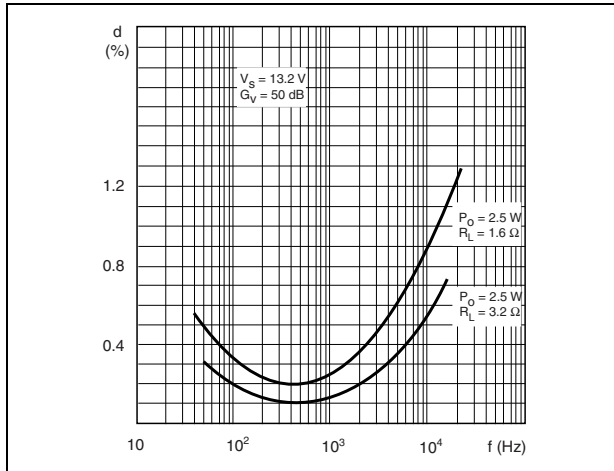

Figure 11. Supply voltage rejection vs.  $C_3$

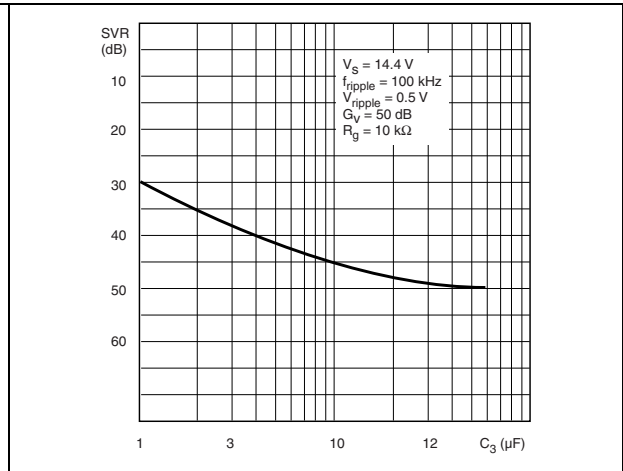

Figure 12. Supply voltage rejection vs. frequency

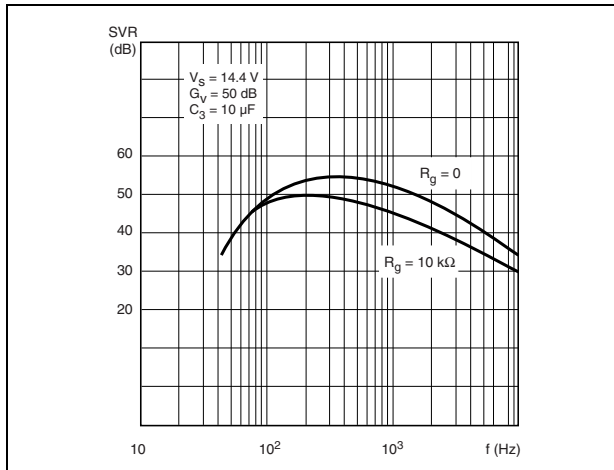

Figure 13. Supply voltage rejection vs.  $C_2$  and  $C_3$ ,  $G_V = 390/1 \Omega$

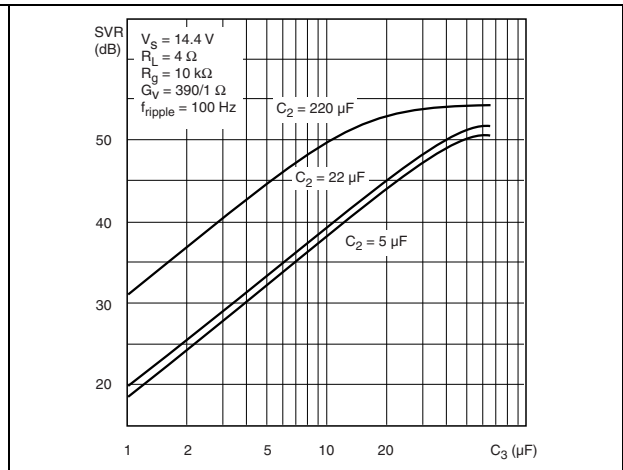

Figure 14. Supply voltage rejection vs.  $C_2$  and  $C_3$ ,  $G_V = 1000/10 \Omega$

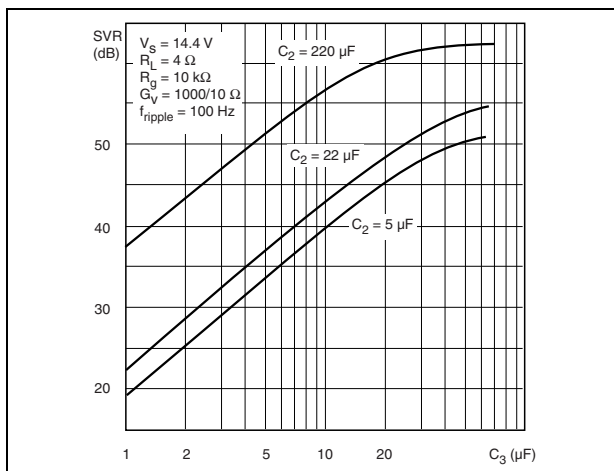

Figure 15. Gain vs. input sensitivity

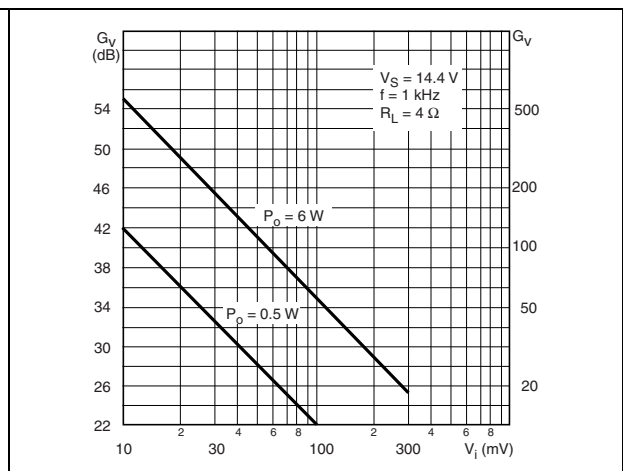

Figure 16. Total power dissipation and efficiency vs. output power ( $R_L = 2 \Omega$ )

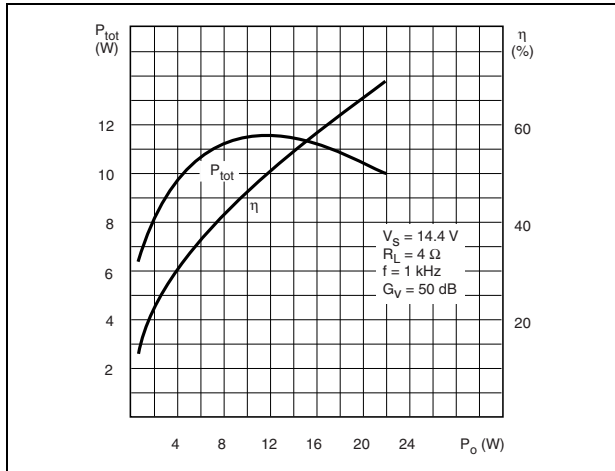

Figure 17. Total power dissipation and efficiency vs. output power ( $R_L = 3.2 \Omega$ )

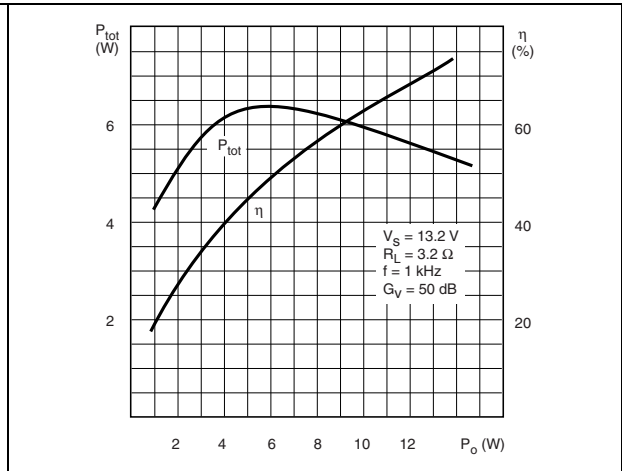
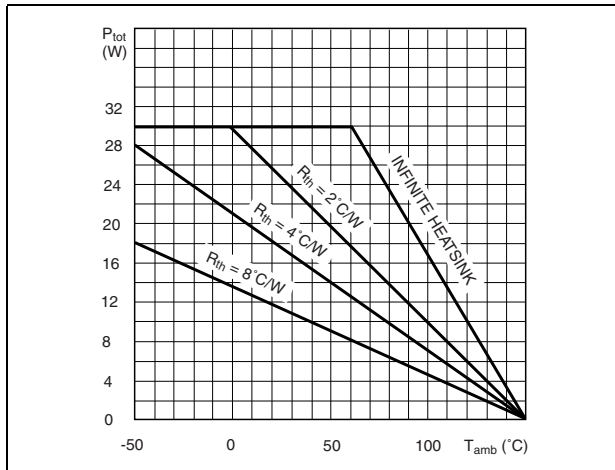

Figure 18. Maximum allowable power dissipation vs. ambient temperature



### 3 Application suggestion

The recommended values of the components are those shown on application circuit of [Figure 2](#). Different values can be used; the following table can help the designer.

**Table 5. Recommended values of the component of the application circuit**

Component	Recommended value	Purpose	Larger than	Smaller than r
R1	120 k $\Omega$	Optimization of the output signal symmetry	Smaller P <sub>omax</sub>	Smaller P <sub>omax</sub>
R2, R4	1 k $\Omega$	Closed loop gain setting (1)	Increase of gain	Decrease of gain
R3, R5	3.3 $\Omega$		Decrease of gain	Increase of gain
R6, R7	1 $\Omega$	Frequency stability	Danger of oscillation at high frequency with inductive load	
C1, C2	2.2 $\mu$ F	Input DC decoupling	High turn-on delay	High turn-on pop, higher low frequency cutoff. Increase of noise
C3	10 $\mu$ F	Ripple rejection	Increase of SVR, Increase of the switch-on time	Degradation of SVR
C4, C6	100 $\mu$ F	Bootstrapping	-	Increase of distortion at low frequency
C5, C7	100 $\mu$ F	Feedback input DC decoupling	-	-
C8, C9	0.1 $\mu$ F	Frequency stability	-	Danger of oscillation
C10, C11	1000 to 2200 $\mu$ F	Output DC decoupling	-	Higher low-frequency cut-off

1. The closed loop gain must be higher than 26 dB.

## 3.1 Built-in protection systems

### 3.1.1 Load dump voltage surge

The TDA2004R has a circuit which enables it to withstand voltage pulse train, on Pin 9, of the type shown in [Figure 20](#). If the supply voltage peaks to more than 40 V, then an LC filter must be inserted between the supply and pin 9, in order to assure that the pulses at pin 9 will be held within the limits shown.

A suggested LC network is shown in [Figure 19](#). With this network, a train of pulses with amplitude up to 120 V and width of 2 ms can be applied at point A. This type of protection is ON when the supply voltage (pulse or DC) exceeds 18 V. For this reason the maximum operating supply voltage is 18 V.

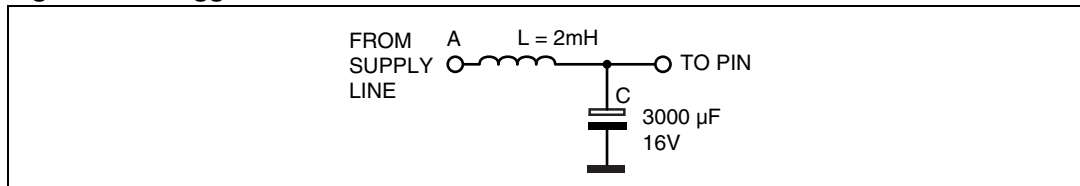
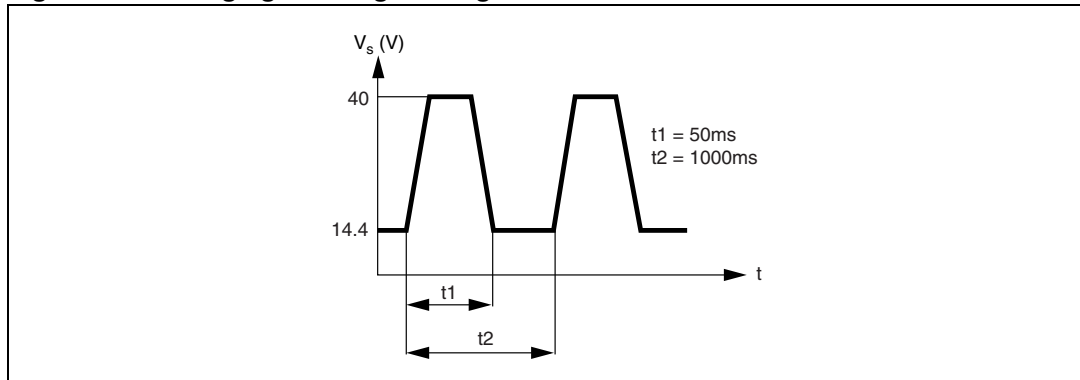
**Figure 19. Suggested LC network circuit****Figure 20. Voltage gain bridge configuration**

### 3.1.2 Short circuit (AC condition)

The TDA2004R can withstand a permanent short-circuit from the output to ground caused by a wrong connection during normal working.

### 3.1.3 Polarity inversion

High current (up to 10 A) can be handled by the device with no damage for a longer period than the blow-out time of a quick 2 A fuse (normally connected in series with the supply). This feature is added to avoid destruction, if during fitting to the car, a mistake on the connection of the supply is made.

### 3.1.4 Open ground

When the ratio is in the ON condition and the ground is accidentally opened, a standard audio amplifier will be damaged. On the TDA2004R protection diodes are included to avoid any damage.

### 3.1.5 Inductive load

A protection diode is provided to allow use of the TDA2004R with inductive loads.

### 3.1.6 DC voltage

The maximum operating DC voltage for the TDA2004R is 18 V. However the device can withstand a DC voltage up to 28 V with no damage. This could occur during winter if two batteries are series connected to crank the engine.

### 3.1.7 Thermal shut-down

The presence of a thermal limiting circuit offers the following advantages:

1. an overload on the output (even if it is permanent), or an excessive ambient temperature can be easily withstood.
2. the heatsink can have a smaller factor of safety compared with that of a conventional circuit. There is no device damage in the case of excessive junction temperature: all that happens is that  $P_o$  (and therefore  $P_{tot}$ ) and  $I_d$  are reduced.

The maximum allowable power dissipation depends upon the size of the external heatsink (i.e. its thermal resistance); [Figure 18](#) shows the power dissipation as a function of ambient temperature for different thermal resistance.

# 4 Package information

In order to meet environmental requirements, ST offers these devices in different grades of ECOPACK® packages, depending on their level of environmental compliance. ECOPACK® specifications, grade definitions and product status are available at: [www.st.com](http://www.st.com).

ECOPACK® is an ST trademark.

**Figure 21. Multiwatt11 mechanical data and package dimensions**

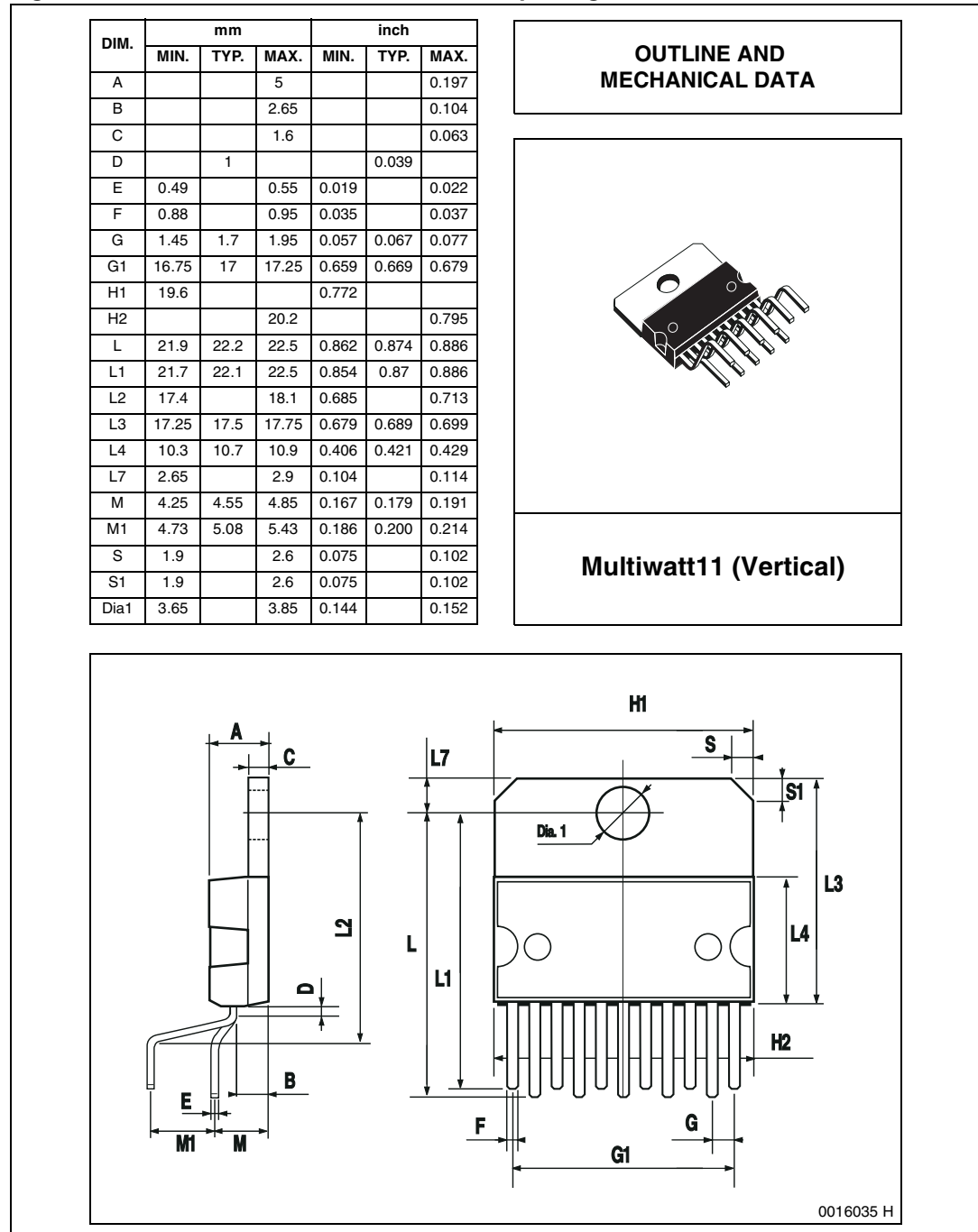

## 5 Revision history

**Table 6. Document revision history**

Date	Revision	Changes
18-Jun-2010	1	Initial release.
18-Sep-2013	2	Updated Disclaimer.



**Please Read Carefully:**

Information in this document is provided solely in connection with ST products. STMicroelectronics NV and its subsidiaries ("ST") reserve the right to make changes, corrections, modifications or improvements, to this document, and the products and services described herein at any time, without notice.

All ST products are sold pursuant to ST's terms and conditions of sale.

Purchasers are solely responsible for the choice, selection and use of the ST products and services described herein, and ST assumes no liability whatsoever relating to the choice, selection or use of the ST products and services described herein.

No license, express or implied, by estoppel or otherwise, to any intellectual property rights is granted under this document. If any part of this document refers to any third party products or services it shall not be deemed a license grant by ST for the use of such third party products or services, or any intellectual property contained therein or considered as a warranty covering the use in any manner whatsoever of such third party products or services or any intellectual property contained therein.

**UNLESS OTHERWISE SET FORTH IN ST'S TERMS AND CONDITIONS OF SALE ST DISCLAIMS ANY EXPRESS OR IMPLIED WARRANTY WITH RESPECT TO THE USE AND/OR SALE OF ST PRODUCTS INCLUDING WITHOUT LIMITATION IMPLIED WARRANTIES OF MERCHANTABILITY, FITNESS FOR A PARTICULAR PURPOSE (AND THEIR EQUIVALENTS UNDER THE LAWS OF ANY JURISDICTION), OR INFRINGEMENT OF ANY PATENT, COPYRIGHT OR OTHER INTELLECTUAL PROPERTY RIGHT.**

**ST PRODUCTS ARE NOT DESIGNED OR AUTHORIZED FOR USE IN: (A) SAFETY CRITICAL APPLICATIONS SUCH AS LIFE SUPPORTING, ACTIVE IMPLANTED DEVICES OR SYSTEMS WITH PRODUCT FUNCTIONAL SAFETY REQUIREMENTS; (B) AERONAUTIC APPLICATIONS; (C) AUTOMOTIVE APPLICATIONS OR ENVIRONMENTS, AND/OR (D) AEROSPACE APPLICATIONS OR ENVIRONMENTS. WHERE ST PRODUCTS ARE NOT DESIGNED FOR SUCH USE, THE PURCHASER SHALL USE PRODUCTS AT PURCHASER'S SOLE RISK, EVEN IF ST HAS BEEN INFORMED IN WRITING OF SUCH USAGE, UNLESS A PRODUCT IS EXPRESSLY DESIGNATED BY ST AS BEING INTENDED FOR "AUTOMOTIVE, AUTOMOTIVE SAFETY OR MEDICAL" INDUSTRY DOMAINS ACCORDING TO ST PRODUCT DESIGN SPECIFICATIONS. PRODUCTS FORMALLY ESCC, QML OR JAN QUALIFIED ARE DEEMED SUITABLE FOR USE IN AEROSPACE BY THE CORRESPONDING GOVERNMENTAL AGENCY.**

Resale of ST products with provisions different from the statements and/or technical features set forth in this document shall immediately void any warranty granted by ST for the ST product or service described herein and shall not create or extend in any manner whatsoever, any liability of ST.

ST and the ST logo are trademarks or registered trademarks of ST in various countries.

Information in this document supersedes and replaces all information previously supplied.

The ST logo is a registered trademark of STMicroelectronics. All other names are the property of their respective owners.

© 2013 STMicroelectronics - All rights reserved

STMicroelectronics group of companies

Australia - Belgium - Brazil - Canada - China - Czech Republic - Finland - France - Germany - Hong Kong - India - Israel - Italy - Japan - Malaysia - Malta - Morocco - Philippines - Singapore - Spain - Sweden - Switzerland - United Kingdom - United States of America

[www.st.com](http://www.st.com)

# AMEYA360

## Components Supply Platform

### Authorized Distribution Brand :



### Website :

Welcome to visit [www.ameya360.com](http://www.ameya360.com)

### Contact Us :

#### ➤ Address :

401 Building No.5, JiuGe Business Center, Lane 2301, Yishan Rd  
Minhang District, Shanghai , China

#### ➤ Sales :

Direct +86 (21) 6401-6692

Email [amall@ameya360.com](mailto:amall@ameya360.com)

QQ 800077892

Skype [ameyasales1](#) [ameyasales2](#)

#### ➤ Customer Service :

Email [service@ameya360.com](mailto:service@ameya360.com)

#### ➤ Partnership :

Tel +86 (21) 64016692-8333

Email [mkt@ameya360.com](mailto:mkt@ameya360.com)