

0.5 mm and 1 mm Pitch, 2.55 mm Height FPC/FFC Connectors

FH28 Series

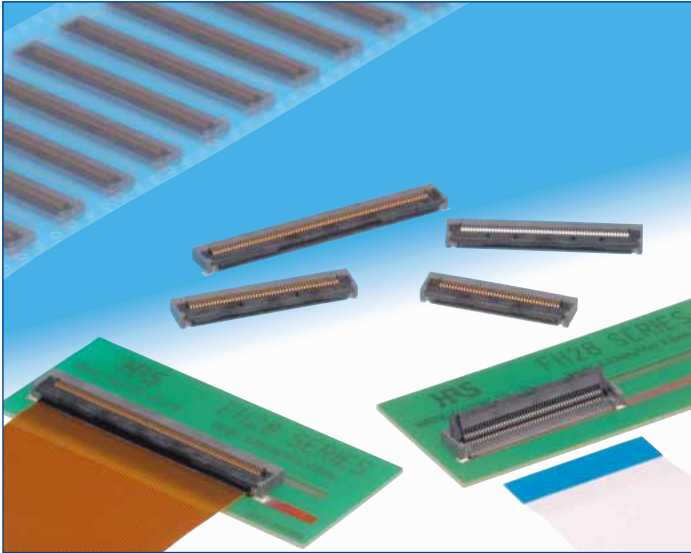

Robust locking structure

Reinforced fitting provide support and prevent the actuator from disengaging from the connector.
Each terminal is attached to the actuator, so the actuator is supported along its entire length.

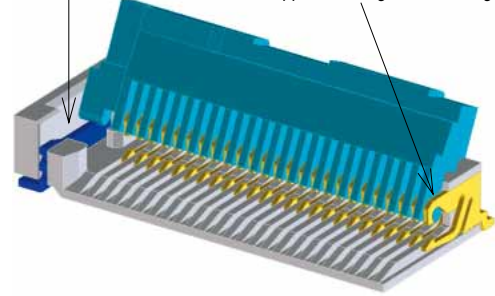

■ Features

1. Highly reliable connection and robust structure

Multi-polarized connectors, reinforced body structure and high FPC retention produced by the following features:

Reliable connection created by its unique FPC/FFC positioning mechanism

Prevents accidental disengagement with the design of its proprietary structure

2. Simplified operations

The flip lock structure makes it easier to engage/disengage the actuator and reduces the required force needed to operate. A clear tactile click is delivered upon the successful completion of the mating process.

3. Increased FPC/FFC retention force

Vertical retention force for the FPC/FFC is 2.5 times stronger than our 0.5 mm pitch connector the FH12 series. Horizontal retention force for the FPC/FFC is 2 times stronger than our 0.5 mm pitch connector the FH12 series

*To realize the horizontal retention force values, the use of the FPC positioning tabs are required. FPC without the positioning tabs will comply with the specifications rated on the FH12 series.

4. Accepts standard 0.3 mm thick FPC/FFC

It accepts 0.3 mm thick products that are easy to manufacture and have superb insertion performance.

5. Fully molded structure aids PCB layout

The bottom of this connector is enclosed by a fully molded structure that protects the contacts and removes any restrictions from PCB patterning and design.

6. Supports automatic pick-n-place mounting

Offered in tape and reel packaging that is compatible with automatic machine mounting. (2,000 pieces per reel)

7. Halogen-free

All materials and substances used to produce this product comply with Halogen-free standards.*Defined according to IEC61249-2-21. Br: 900 ppm maximum, Cl: 900 ppm maximum, Br+Cl: 1,500 ppm maximum

8. Multiple packing options

The standard packaging is 2,000 pieces per reel, but it is also offered in a 500 piece reel. (The outer diameter of the reel will be ϕ 330 mm in this case.)

The FPC positioning mechanism and FPC tabs help to guide and hold the FPC prior to engaging the actuator

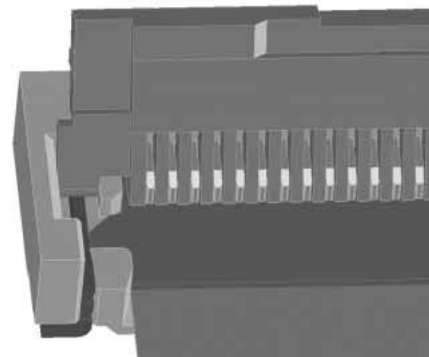

Can also be used with straight sided, non-tabbed FPC/FFC

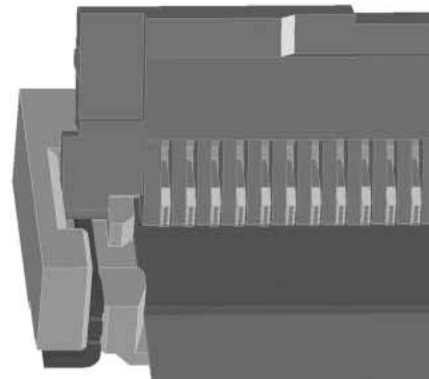

Product Specifications

Ratings	Rated Current	0.5 A (Note 1)	Operating Temperature Range	Storage Temperature Range
	Rated Voltage	AC 50 Vrms	-40 ~ +85°C (Note 2)	-10 ~ +50°C (Note 3)
			Operating Humidity Range	Storage Humidity Range
			Relative humidity 90% or less (no condensation should be present)	

Adaptive FPC/FFC contact specifications	t= 0.3 ±0.05 Gold plating
---	---------------------------

Item	Specification	Conditions
1. Insulation Resistance	Minimum of 500 MΩ	Measured with DC 100 V
2. Withstanding Voltage	No flashover or breakdown	AC 150 Vrms is applied for one minute.
3. Contact Resistance	Maximum of 50 mΩ *including FPC/FFC conductor resistance	Measured at 1mA (DC or 1,000Hz)
4. Durability	Contact Resistance: Maximum of 50 mΩ No damaged, cracked or looseness of parts	20 mating cycles
5. Vibration Resistance	No electrical discontinuity of 1μs or greater Contact Resistance: Maximum of 50 mΩ No damages, cracks and looseness of parts	Frequency: 10 to 55Hz Single amplitude of 0.75mm for 10 cycles in 3 axial directions
6. Shock Resistance	No electric discontinuity of 1μs or greater Contact Resistance: Maximum of 50 mΩ No damaged, cracked or looseness of parts	Acceleration of 981m/s ² , 6ms duration, sine half-wave waveform 3 cycles in each of the 3 axis
7. Humidity Resistance of Steady State	Contact Resistance: Maximum of 50 mΩ Insulation Resistance: Minimum of 50 MΩ No damaged, cracked or looseness of parts	96 hours at temperature: 40°C and humidity: 90 to 95%
8. Temperature Cycles	Contact Resistance: Maximum of 50 mΩ Insulation Resistance: Minimum of 50 MΩ No damaged, cracked or looseness of parts	Temperature: -40→+15 to +35→+85→+15 to +35°C Time: 30→2 to 3→30→2 to 3 minutes 5 cycles
9. Solder Heat Resistance	Should not have external deformity or loose parts	Reflow: according to the Recommended Temperature Profile Hand solder: 350 ±5°C for 5 seconds

(Note 1) When energizing rated current to all contacts, use 70% of rated current.

(Note 2) Includes temperature rise caused by current flow.

(Note 3) The term "storage" here refers to products stored for a long period prior to board mounting and use. The operating temperature and humidity range covers the non-energized condition of connectors after board mounting and the temporary storage.

Materials

Component	Materials	Color/Finish	Remarks
Insulator	LCP	Gray	UL94V-0
	LCP	Black	
Contact	Phosphor bronze	Gold plating	_____
Metal fitting	Brass	Pure tin plating	_____

Product Number Structure

Refer to this page when determining product specifications by model types. Please place orders with part numbers listed in this catalog. The characteristics and specifications of the product described in this catalog are reference values. Please make sure to check the latest delivery specifications at the time of product use.

FH 28 D - 50 (25) S B - 0.5 SH (05)

①
②
③
④
⑤
⑥
⑦
⑧
⑨
⑩

① Series Name: FH	⑥ Contact arrangement: Single (single row)
② Series No.: 28	⑦ Eccentric direction: Blank...Standard type (without eccentricity) B...Eccentric type (contacts on the opposite side of polarity mark)
③ None, D: Standard type E: Long reinforcing fitting type H: Space-saving type	⑧ Contact Pitch: 0.5 mm, 1 mm
④ Standard type: The number of contacts Eccentric type: Number of contacts in 0.5mm housing	⑨ Mounting direction, SH...SMT horizontal mounting type
⑤ Standard type: Blank Eccentric type: Actual number of pins	⑩ Specification: (05) ...Gold plating, 2,000 pieces per reel (10) Specification:...Partial gold plating, 2,000 pieces per reel (07)...Gold plating (for 40 contact only.), 2,000 pieces per reel (98)...Gold plating, 500 pieces per reel

Connector Dimensions

[Standard type] 0.5 mm pitch product

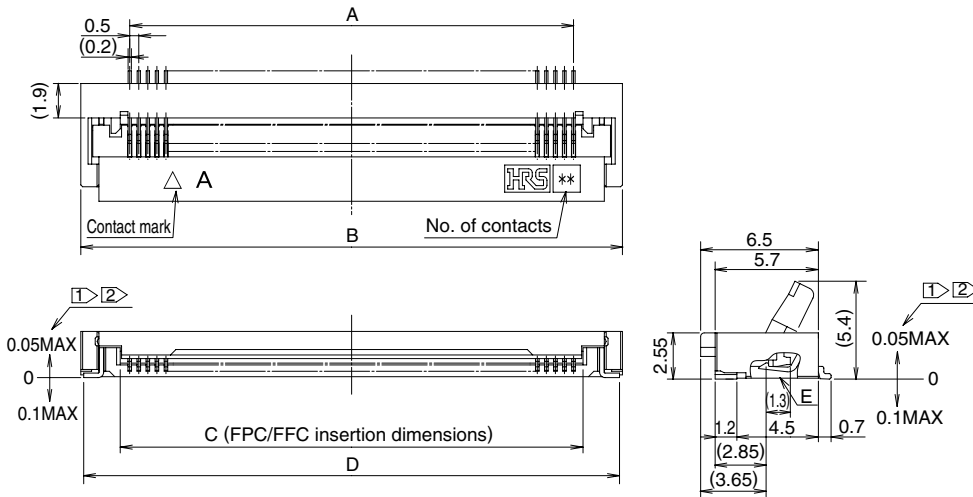

- Notes
- 1 The coplanarity of the metal fitting and contact is 0.1 MAX.
 - 2 The contact lead position shows the dimension from the E surface of the case bottom.
 - 3 This product is sold in embossed, tape and reel packaging. For details on this product please refer to the “Packaging Specifications” located on page 9.
 - 4 Recesses in part structure may be added to improve molding characteristics.
Black marks may appear in the mold resin, but they will not negatively affect the performance of these connectors.
 - 5 The color of the plating may change after the reflow process, but it will not negatively affect the performance of these connectors.

Connector dimension table [Standard type]

Unit: mm

Part No.	HRS No.	No. of Contacts	A	B	C	D
FH28-10S-0.5SH(**)	CL586-1861-4-**-	10	4.5	9.9	5.57	9.58
FH28-15S-0.5SH(**)	CL586-1868-3-**-	15	7	12.4	8.07	12.08
FH28D-20S-0.5SH(**)	CL586-1823-5-**-	20	9.5	14.9	10.57	14.58
FH28D-28S-0.5SH(**)	CL586-1835-4-**-	28	13.5	18.9	14.57	18.58
FH28D-30S-0.5SH(**)	CL586-1827-6-**-	30	14.5	19.9	15.57	19.58
FH28-40S-0.5SH(**)	CL586-1803-8-**-	40	19.5	24.9	20.57	24.58
FH28-45S-0.5SH(**)	CL586-1848-6-**-	45	22	27.4	23.07	27.08
FH28D-50S-0.5SH(**)	CL586-1808-1-**-	50	24.5	29.9	25.57	29.58
FH28D-55S-0.5SH(**)	CL586-1821-0-**-	55	27.0	32.4	28.07	32.08
FH28-60S-0.5SH(**)	CL586-1811-6-**-	60	29.5	34.9	30.57	34.58
FH28D-64S-0.5SH(**)	CL586-1813-1-**-	64	31.5	36.9	32.57	36.58
FH28D-68S-0.5SH(**)	CL586-1819-8-**-	68	33.5	38.9	34.57	38.58
FH28D-74S-0.5SH(**)	CL586-1828-9-**-	74	36.5	41.9	37.57	41.58

(Note 1) This product is sold in embossed, tape and reel packaging. This product is sold in full reel quantities of either 2,000 or 500 piece reels. Please place orders by full reel quantities.

Connector Dimensions

[Standard type] 1 mm pitch product

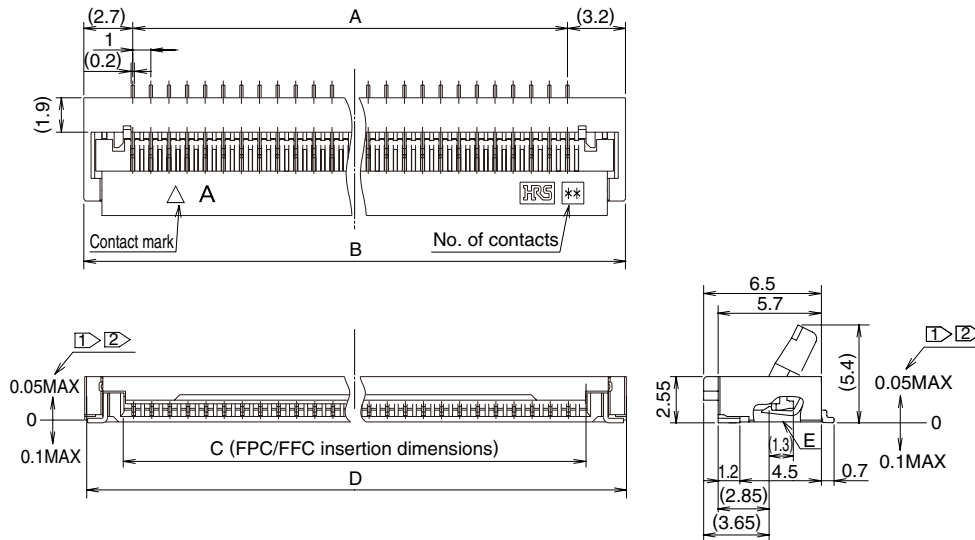

- Notes
- ① The lead flatness of metal fitting and contact is 0.1 MAX.
 - ② The contact lead position shows the dimension from the E surface of the case bottom.
 - 3 This product is sold in embossed, tape and reel packaging. For details on this product please refer to the "Packaging Specifications" located on page 9.
 - 4 Recesses in part structure may be added to improve molding characteristics
Black marks may appear in the mold resin, but they will not negatively affect the performance of these connectors.
 - 5 The color of the plating may change after the reflow process, but it will not negatively affect the performance of these connectors.

Connector dimension table [Standard type]

Unit: mm

Part No.	HRS No.	No. of Contacts	A	B	C	D
FH28D-20(10)SB-1SH(**)	CL586-1863-0-**-	10	9	14.9	10.57	14.58
FH28D-30(15)SB-1SH(**)	CL586-1860-1-**-	15	14	19.9	15.57	19.58
FH28-40(20)SB-1SH(**)	CL586-1832-6-**-	20	19	24.9	20.57	24.58
FH28D-50(25)SB-1SH(**)	CL586-1817-2-**-	25	24	29.9	25.57	29.58
FH28-60(30)SB-1SH(**)	CL586-1818-5-**-	30	29	34.9	30.57	34.58
FH28D-64(32)SB-1SH(**)	CL586-1852-3-**-	32	31	36.9	32.57	36.58
FH28D-68(34)SB-1SH(**)	CL586-1812-9-**-	34	33	38.9	34.57	38.58

(Note 1) This product is sold in embossed, tape and reel packaging. This product is sold in full reel quantities of either 2,000 or 500 piece reels. Please place orders by full reel quantities.

■ Connector Dimensions [Space-saving type]

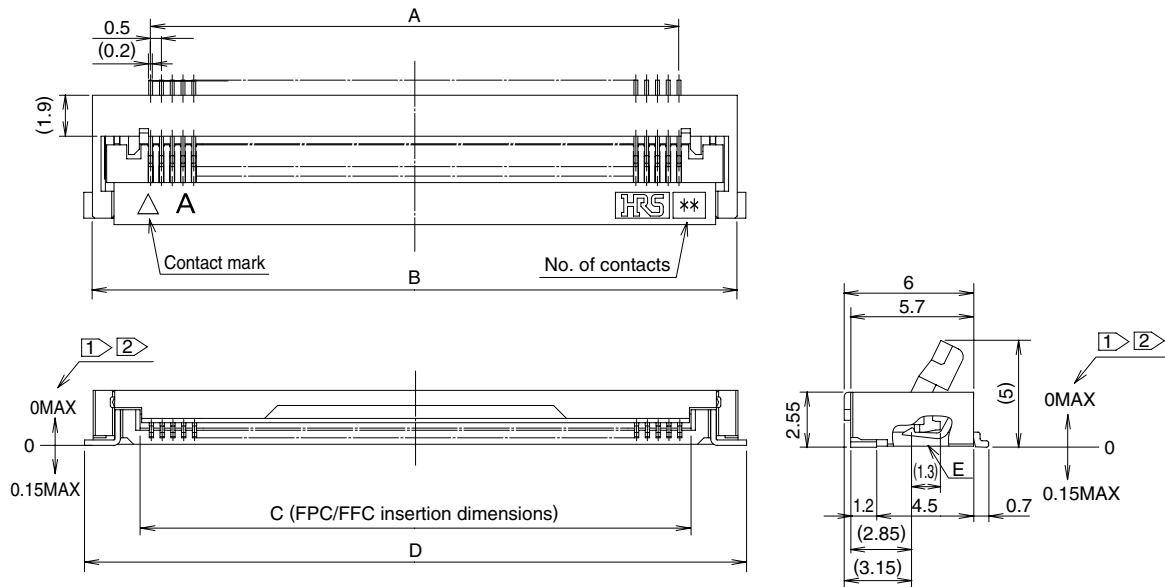

- Notes
- ① The lead flatness of metal fitting and contact is 0.1 MAX.
 - ② The contact lead position shows the dimension from the E surface of the case bottom.
 - 3 This product is sold in embossed, tape and reel packaging. For details on this product please refer to the “Packaging Specifications” located on page 9.
 - 4 Recesses in part structure may be added to improve molding characteristics
Black marks may appear in the mold resin, but they will not negatively affect the performance of these connectors.
 - 5 The color of the plating may change after the reflow process, but it will not negatively affect the performance of these connectors.

■ Connector dimension table [Space-saving type]

Unit: mm

Part No.	HRS No.	No. of Contacts	A	B	C	D
FH28H-80S-0.5SH(**)	CL586-1805-3-**-	80	39.5	44.9	40.57	45.7

(Note 1) This product is sold in embossed, tape and reel packaging. This product is sold in full reel quantities of either 2,000 or 500 piece reels. Please place orders by full reel quantities.

Recommended PCB layout and metal mask dimensions for 0.5 mm pitch products

Recommended metal mask thickness: $t = 0.15$

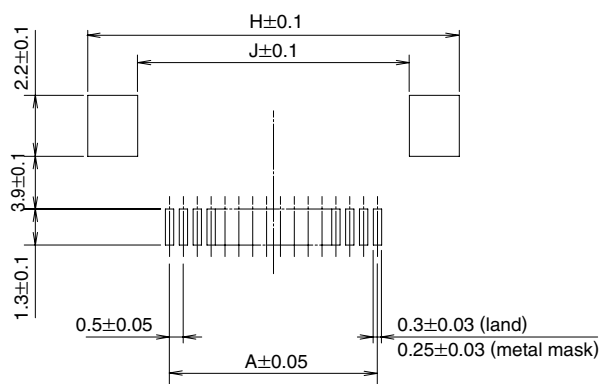

Standard type (FH28, FH28D)

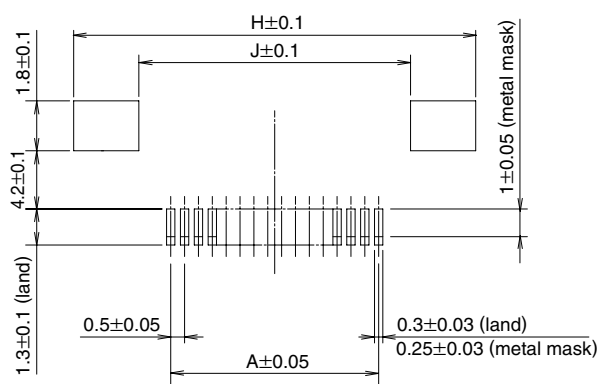

Space-saving type (FH28H)

Recommended FPC/FFC dimensions for 0.5 mm pitch products

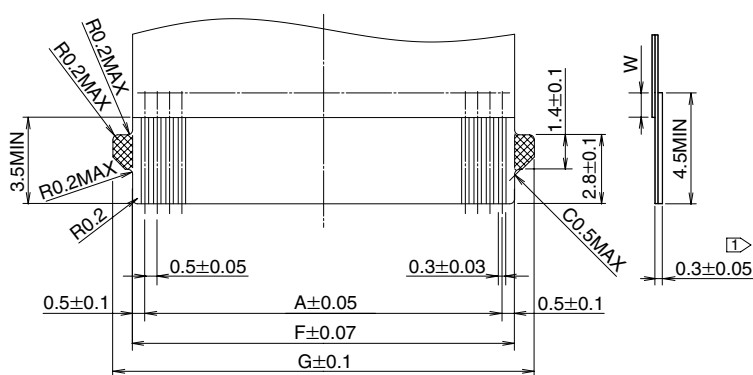

- Notes
- 1 The stiffener needs to be a minimum of 0.188 (7.5 mil) thick.
 - 2 The W dimension needs to be a minimum of 0.5 mm.

Recommended PCB layout, metal mask and FPC dimensions for 0.5 mm pitch products

Unit: mm

Part No.	HRS No.	No. of Contacts	F	G	H	J
FH28-10S-0.5SH(**)	CL586-1861-4-***	10	5.5	7.1	10.6	7
FH28-15S-0.5SH(**)	CL586-1868-3-***	15	8	9.6	13.1	9.5
FH28D-20S-0.5SH(**)	CL586-1823-5-***	20	10.5	12.1	15.6	12.0
FH28D-28S-0.5SH(**)	CL586-1835-4-***	28	14.5	16.1	19.6	16.0
FH28D-30S-0.5SH(**)	CL586-1827-6-***	30	15.5	17.1	20.6	17.0
FH28-40S-0.5SH(**)	CL586-1803-8-***	40	20.5	22.1	25.6	22.0
FH28-45S-0.5SH(**)	CL586-1848-6-***	45	23	24.6	28.1	24.5
FH28D-50S-0.5SH(**)	CL586-1808-1-***	50	25.5	27.1	30.6	27.0
FH28D-55S-0.5SH(**)	CL586-1821-0-***	55	28.0	29.6	33.1	29.5
FH28-60S-0.5SH(**)	CL586-1811-6-***	60	30.5	32.1	35.6	32.0
FH28D-64S-0.5SH(**)	CL586-1813-1-***	64	32.5	34.1	37.6	34.0
FH28D-68S-0.5SH(**)	CL586-1819-8-***	68	34.5	36.1	39.6	36.0
FH28D-74S-0.5SH(**)	CL586-1828-9-***	74	37.5	39.1	42.6	39.0
FH28H-80S-0.5SH(**)	CL586-1805-3-***	80	40.5	42.1	46.7	42.0

Recommended PCB layout and metal mask dimensions for 1 mm pitch products

Recommended metal mask thickness: $t = 0.15$

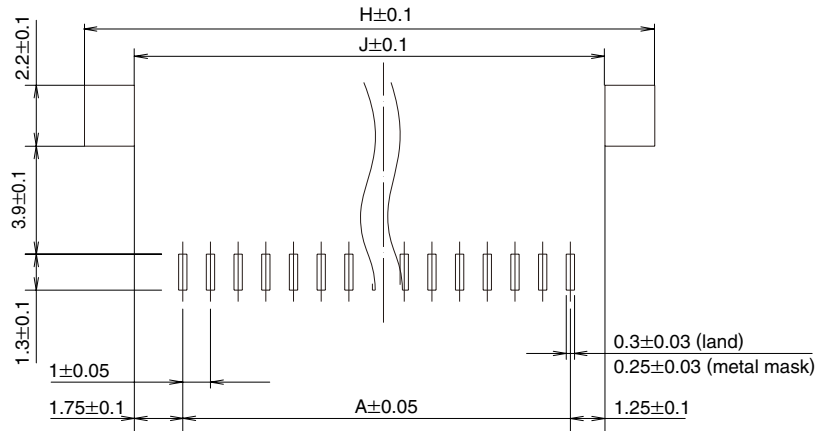

Recommended FPC/FFC dimensions for 1mm pitch products

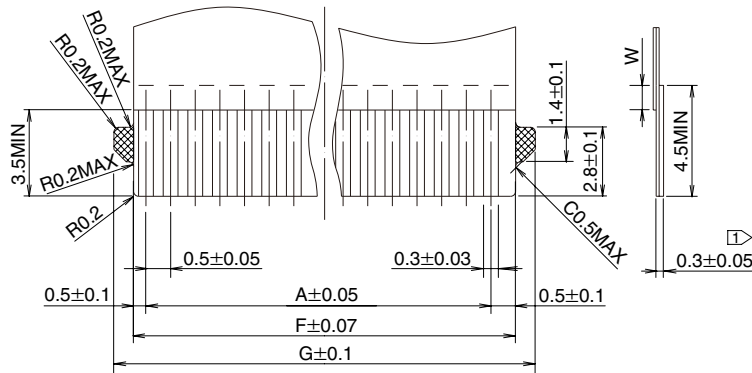

Note 1 The stiffener needs to be a minimum of 0.188 (7.5 mil) thick.

Note 2 The W dimension needs to be a minimum of 0.5 mm.

Recommended PCB layout, metal mask and FPC dimensions for 1 mm pitch products

Unit: mm

Part No.	HRS No.	No. of Contacts	F	G	H	J
FH28D-20(10)SB-1SH(**)	CL586-1863-0-**-	10	10.5	12.1	15.6	12
FH28D-30(15)SB-1SH(**)	CL586-1860-1-**-	15	15.5	17.1	20.6	17
FH28-40(20)SB-1SH(**)	CL586-1832-6-**-	20	20.5	22.1	25.6	22
FH28D-50(25)SB-1SH(**)	CL586-1817-2-**-	25	25.5	27.1	30.6	27
FH28-60(30)SB-1SH(**)	CL586-1818-5-**-	30	30.5	32.1	35.6	32
FH28D-64(32)SB-1SH(**)	CL586-1852-3-**-	32	32.5	34.1	37.6	34
FH28D-68(34)SB-1SH(**)	CL586-1812-9-**-	34	34.5	36.1	39.6	36

FH28 Series FPC/FFC Material Configuration (Recommended Specifications)

1. Single-Sided FPC

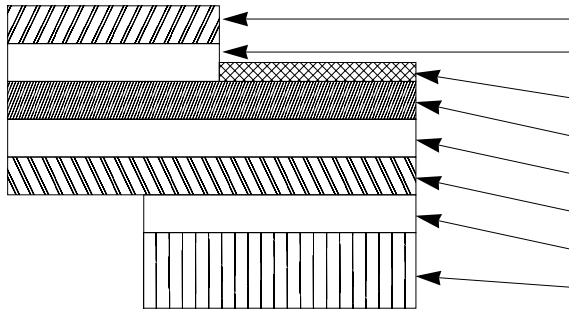

FPC : Flexible Printed Circuit

Layer	Materials	Thickness (μm)
Cover lay film	Polymide 1mil	(25)
Cover adhesive		(25)
Surface treatment	Under nickel plating 1~5 μm+gold plating 0.2 μm	3
Copper foil	Cu 1oz	35
Base adhesive	Heat stiffener adhesive	25
Base film	Polymide 1mil	25
Stiffener adhesive	Heat stiffener adhesive	30
Reinforcing film	Polymide 7mil	175
Total		293

2. Double-sided FPC

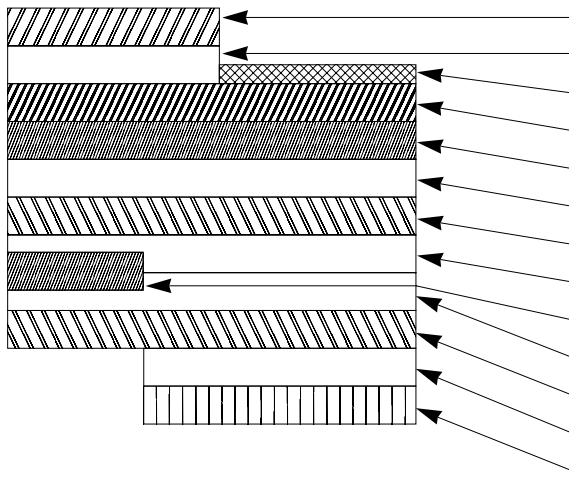

FPC : Flexible Printed Circuit

Layer	Materials	Thickness (μm)
Cover lay film	Polymide 1mil	(25)
Cover adhesive		(25)
Surface treatment	Under nickel plating 1~5 μm+ gold plating 0.2 μm	3
Through hole copper	Cu	15
Copper foil	Cu 1/2oz	18
Base adhesive	Heat stiffener adhesive	18
Base film	Polymide 1mil	25
Base adhesive	Heat stiffener adhesive	18
Copper foil	Cu 1/2oz	(18)
Cover adhesive	Heat stiffener adhesive	25
Cover lay film	Polymide 1mil	25
Stiffener adhesive	Heat stiffener adhesive	50
Reinforcing film	Polymide 4mil	100
Total		297

* Remove the copper foil on the back of double-sided FPC to avoid damage due to FPC bending.

3. FFC

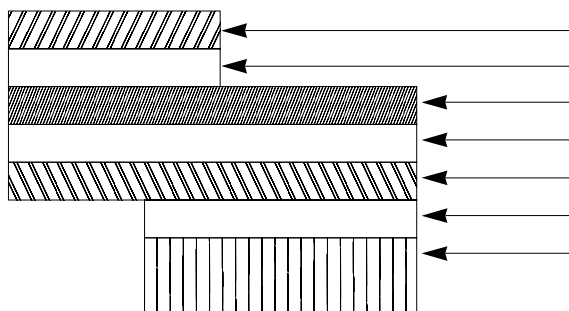

FFC : Flexible Flat Cable

Layer	Materials	Thickness (μm)
Polyester film		12
Adhesive	Polyester thermal plasticity	30
Annealed copper foil (Gold plated with under nickel plating)		35
Adhesive	Polyester type	30
Polyester		12
Adhesive	Polyester type	30
Reinforcing film	Polyester type	188
Total		295

Nominal thickness tolerance is approximately ±20μm.

1. These specifications are an example of the material configuration of an FPC/FFC (t= 0.3 ±0.05) used on the FH28 series.
2. Please contact the FPC/FFC manufacturer for the material configurations of their FPC/FFC.

■ Packaging Specifications

[Common specifications for FH28 Series]

● Embossed Carrier Tape Dimensions (with a maximum tape width of 24 mm)

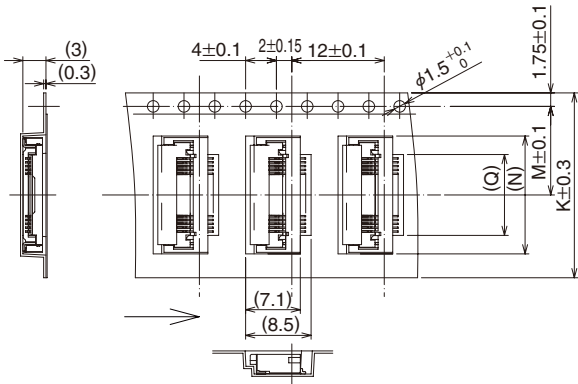

Standard type (FH28, FH28D)

● Embossed Carrier Tape Dimensions (with a minimum tape width of 32 mm)

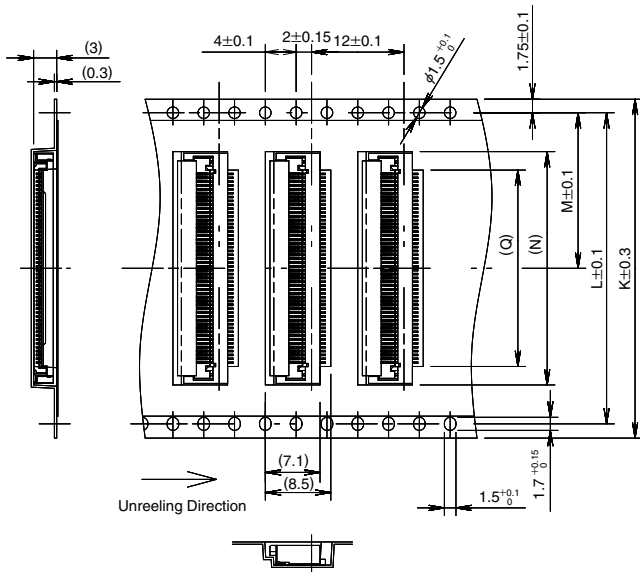

Standard type (FH28, FH28D)

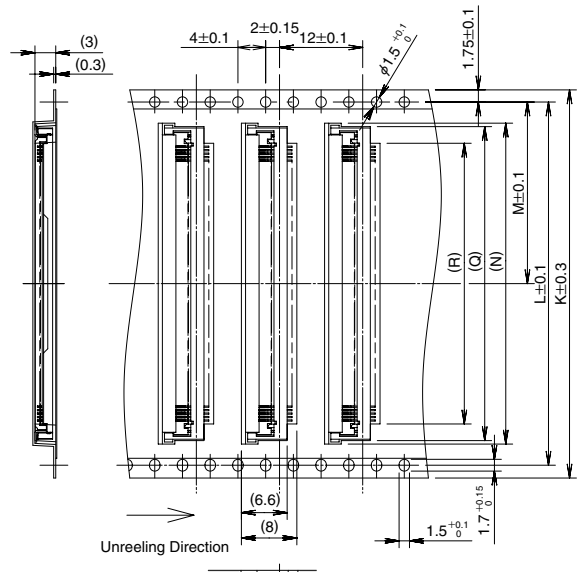

Space-saving type (FH28H)

● Reel Dimensions

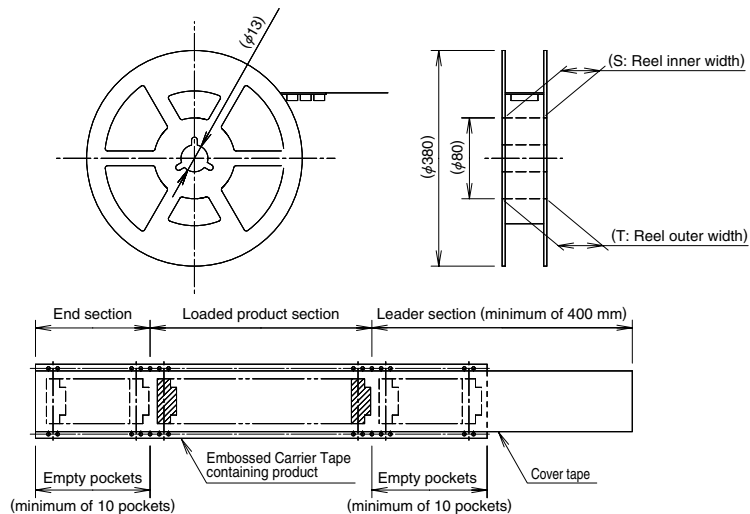

■Packaging specification dimensions [standard type] for 0.5 mm pitch products

Unit: mm

Part No.	HRS No.	No. of Contacts	K	L	M	N	Q	S	T
FH28-10S-0.5SH(**)	CL586-1861-4-**-	10	24	—	11.5	10.3	5.5	25.4	29.4
FH28-15S-0.5SH(**)	CL586-1868-3-**-	15	24	—	11.5	12.8	8	25.4	29.4
FH28D-20S-0.5SH(**)	CL586-1823-5-**-	20	24	—	11.5	15.3	10.5	25.4	29.4
FH28D-28S-0.5SH(**)	CL586-1835-4-**-	28	32	28.4	14.2	19.3	14.5	33.4	37.4
FH28D-30S-0.5SH(**)	CL586-1827-6-**-	30	32	28.4	14.2	20.3	15.5	33.4	37.4
FH28-40S-0.5SH(**)	CL586-1803-8-**-	40	44	40.4	20.2	25.3	20.5	33.4	37.4
FH28-45S-0.5SH(**)	CL586-1848-6-**-	45	44	40.4	20.2	27.8	23	45.4	49.4
FH28D-50S-0.5SH(**)	CL586-1808-1-**-	50	44	40.4	20.2	30.3	25.5	45.4	49.4
FH28D-55S-0.5SH(**)	CL586-1821-0-**-	55	44	40.4	20.2	32.8	28.0	45.4	49.4
FH28-60S-0.5SH(**)	CL586-1811-6-**-	60	56	52.4	26.2	35.3	30.5	57.4	61.4
FH28D-64S-0.5SH(**)	CL586-1813-1-**-	64	56	52.4	26.2	37.3	32.5	57.4	61.4
FH28D-68S-0.5SH(**)	CL586-1819-8-**-	68	56	52.4	26.2	39.3	34.5	57.4	61.4
FH28D-74S-0.5SH(**)	CL586-1828-9-**-	74	56	52.4	26.2	43.3	42.3	57.4	61.4

■Packaging specification dimensions [standard type] for 1 mm pitch products

Unit: mm

Part No.	HRS No.	No. of Contacts	K	L	M	N	Q	S	T
FH28D-20(10)SB-1SH(**)	CL586-1863-0-**-	10	24	—	11.5	15.3	10.5	25.4	29.4
FH28D-30(15)SB-1SH(**)	CL586-1860-1-**-	15	32	28.4	14.2	20.3	15.5	33.4	37.4
FH28-40(20)SB-1SH(**)	CL586-1832-6-**-	20	44	40.4	20.2	25.3	20.5	45.4	49.4
FH28D-50(25)SB-1SH(**)	CL586-1817-2-**-	25	44	40.4	20.2	30.3	25.5	45.4	49.4
FH28-60(30)SB-1SH(**)	CL586-1818-5-**-	30	56	52.4	26.2	35.3	30.5	57.4	61.4
FH28D-64(32)SB-1SH(**)	CL586-1852-3-**-	32	56	52.4	26.2	37.3	32.5	57.4	61.4
FH28D-68(34)SB-1SH(**)	CL586-1812-9-**-	34	56	52.4	26.2	39.3	34.5	57.4	61.4

■Packaging specification dimensions [Space-saving type]

Unit: mm

Part No.	HRS No.	No. of Contacts	K	L	M	N	Q	R	S	T
FH28H-80S-0.5SH(**)	CL586-1805-3-**-	80	56	52.4	26.2	46.3	45.3	40.5	57.4	61.4

■Recommended soldering profile

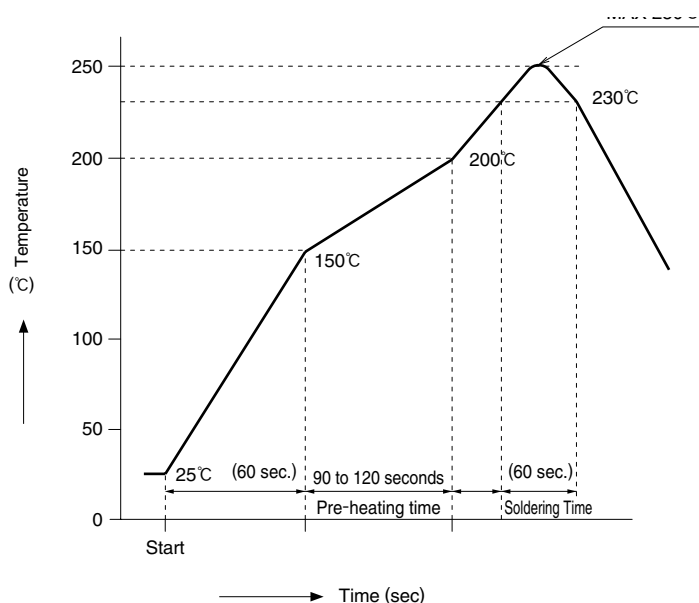

Applicable Conditions

Reflow type : Far red/hot air reflow
 Reflow furnace atmosphere : Atmosphere
 Soldering : Cream type
 Sn/3.0Ag/0.5Cu
 (M705-221CM5-32-10.5 made by Senju Metal Industry Co.)
 Testing PCB : Glass epoxy 55×150×1.6 mm

Land/metal mask dimensions Our recommendation conditions

This solder profile is based on the conditions provided above.

Please check the mounting conditions before use, conditions such as solder paste types, manufacturer, PCB size and any other soldering materials may alter the performance of such materials.

■ Operation Methods of Connector and Precautions

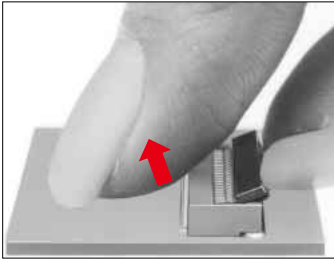
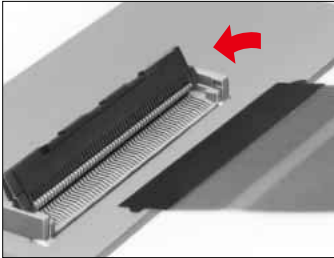
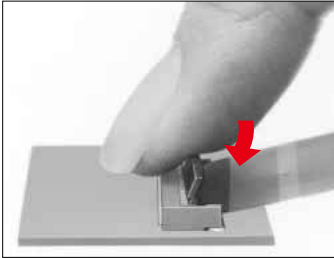
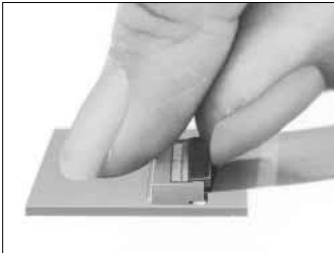
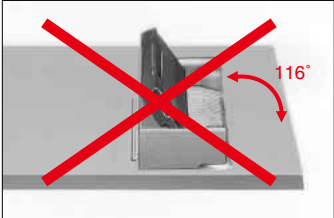
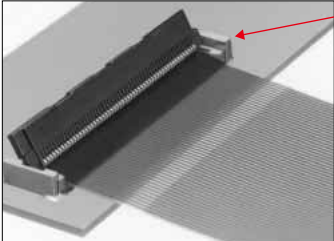
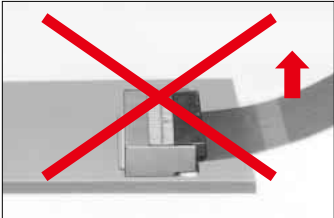
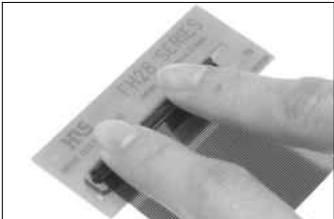
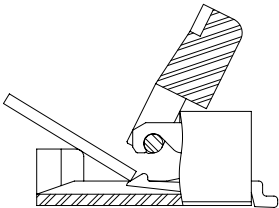
Operation Methods	Precautions for use
<p>1. FPC/FFC insertion method</p> <p>① Rotate the actuator upward to unlock it The actuator can be easily operated with the use of a thumb nail or index finger.</p>  <p>② Insert the FPC/FFC with the contact surface facing down. FH28 is a bottom contact type connector. Insert FPC/FFC from the diagonally left side of the connector. Insert the FPC/FFC at a diagonal angle and lay it into position. Insert it until the FPC/FFC is securely hooked on the positioning area. Check to see if it is retained by pulling lightly on it. For detail, refer to the next page.</p>  <p>③ Rotate the actuator downward.</p>  <p>2. Removing the FPC/FFC</p> <p>① Rotate the actuator upward, then angle the FPC/FFC upward after the actuator has been released and remove the FPC/FFC straight out.</p> 	<p>① The actuator on the FH28 series connector is designed to open to a maximum of 116 degrees, trying to open it farther than that will lead to damage.</p>  <p>② Insert the FPC/FFC into the insertion slot as show below. Improper insertion can lead to damage and ultimately malfunction.</p>  <p>③ Do not pull on the FPC/FFC in an upward direction, doing this can damage the connector as it is not equipped to handle a large amount of force in this direction.</p>  <p>④ When dealing with a higher contact count (80 positions), be sure to use two fingers to close the actuator on both sides. Using one finger might not close it completely and leave an incomplete connection.</p>  <p>⑤ When inserting FPC/FFC, do not rub it hard on the lower surface of the insertion slot of the connector. Otherwise, the contact hits hard on the FPC/FFC, and may cause the deformation of the contact or conductor separation etc. of the FPC/FFC. During the insertion of the FPC/FFC, make sure that</p> 

■ Cautions when mating FFFC/FPC with positioning tabs

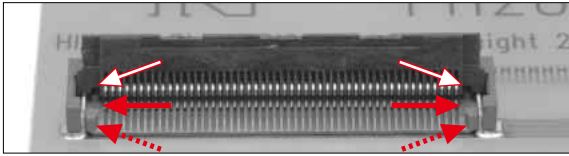
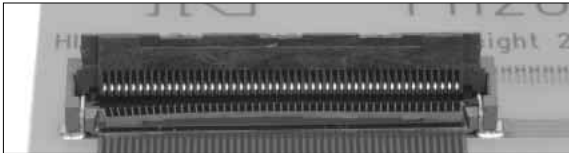
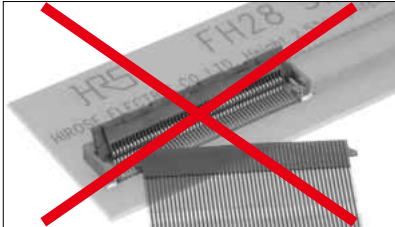
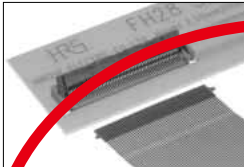
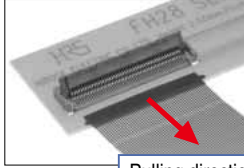
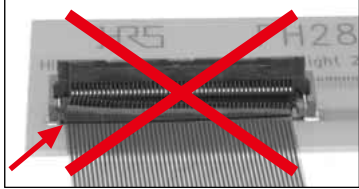
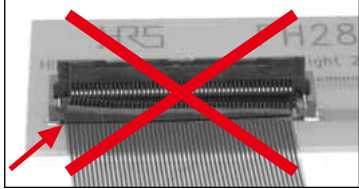
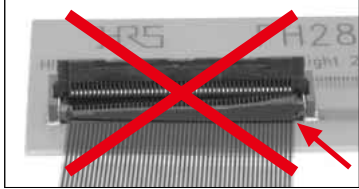
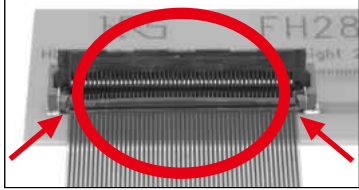
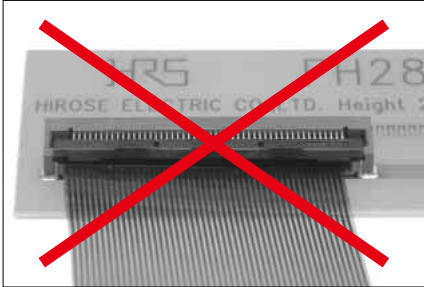
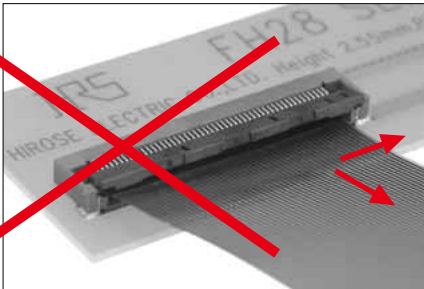
Operation Methods	Precautions for use
<p>1. Position for insertion</p> <p>Insert the cable into the gap (.....▶) between the side walls (=>) on both sides of the cable insertion port' and the 'guide walls (→) on both sides of the inner part of the connector' putting the tab of the cable on the gap.</p>   <p>2. Cautions during insertion/mating</p> <p>❶ Do not insert the FPC/FFC at an skewed angle (as shown), this type of action may cause the corner of the cable to get hooked and deform its contacts.</p> <p>Skewed insertion </p> <p>Insert the cable straight into the connector opening and hook the cable tab onto the guide. Pull the cable towards yourself with a slight force after insertion, and close the actuator after confirming that the cable tab is completely secured. If it cannot be pulled to out, the cable can be determined to be inserted into the correct position.</p> <p>Recommended mating method</p>  <p>❶ Insert the cable straight from the diagonally left side.</p>  <p>❷ Pull the cable lightly to yourself and check if the tab is secured.</p> <p>Pulling direction</p>  <p>❸ Close the actuator.</p>	<p>❷ PC/FFC must not over lap</p> <p>Do not close the actuator until the FPC/FFC has been placed into its correct position. If it is sitting on the guides and the actuator closes onto it, it can cause damage and alter its performance.</p> <p>Incorrectly placed onto the left guide </p> <p>Incorrectly placed onto the right guide </p> <p>Normal insertion </p> <p>Do not close the actuator with the cable sitting on either guide.</p>  <p>In case you accidentally close the lock with the cable sitting on the guides, do not move the cable around to make it seat. Open the actuator immediately and reposition the cable as explained in “1. Position for insertion” noted above.</p> 

AMEYA360

Components Supply Platform

Authorized Distribution Brand :



Website :

Welcome to visit www.ameya360.com

Contact Us :

➤ Address :

401 Building No.5, JiuGe Business Center, Lane 2301, Yishan Rd
Minhang District, Shanghai , China

➤ Sales :

Direct +86 (21) 6401-6692

Email amall@ameya360.com

QQ 800077892

Skype [ameyasales1](#) [ameyasales2](#)

➤ Customer Service :

Email service@ameya360.com

➤ Partnership :

Tel +86 (21) 64016692-8333

Email mkt@ameya360.com