

DS100RT410 Low Power 10GbE Quad Channel Retimer

Check for Samples: [DS100RT410](#)

FEATURES

- Each channel independently locks to 10.3125 Gbps
- Lock time operation (typically under 15 ms)
- Low latency (~300 ps)
- Adaptive equalization up to 34 dB boost at 5 GHz
- Adjustable transmit V_{OD} : 600 to 1300 mVp-p
- Adjustable transmit de-emphasis to -12 dB
- Typical Power Dissipation (EQ+CDR+DE): 150 mW / channel
- Programmable output polarity inversion
- Input signal detection, CDR lock detection/indicator
- On-chip Eye Monitor (EOM), PRBS generator
- Single 2.5 V $\pm 5\%$ power supply
- SMBus/EEPROM configuration modes
- Operating temperature range of -40 to 85°C
- RHS 48-pin, 7 mm x 7 mm package
- Easy pin compatible upgrade between repeater and retimers

- DS100RT410 (EQ+CDR+DE): 10.3125 Gbps
- DS100DF410 (EQ+DFE+CDR+DE): 10.3125 Gbps
- DS110RT410 (EQ+CDR+DE): 8.5 - 11.3 Gbps
- DS110DF410 (EQ+DFE+CDR+DE): 8.5 - 11.3 Gbps
- DS125RT410 (EQ+CDR+DE): 9.8 - 12.5 Gbps
- DS125DF410 (EQ+DFE+CDR+DE): 9.8 - 12.5 Gbps
- DS100BR410 (EQ+DE): Up to 10.3125 Gbps

APPLICATIONS

- Front port SFF 8431 (SFP+) optical and direct attach copper
 - Backplane reach extension, data retimer
 - Ethernet: 10GbE, 1GbE
- For other data rates and data transmission protocols, other pin-compatible devices in the retimer family can be used.

DESCRIPTION

The DS100RT410 is a four channel retimers with integrated signal conditioning. Each channel can independently lock to 10.3125 Gbps data rate to support 10GbE. The device includes a fully adaptive Continuous-Time Linear Equalizer (CTLE), Clock and Data Recovery (CDR) and transmit De-Emphasis (DE) driver to enable data transmission over long, lossy and crosstalk-impaired highspeed serial links to achieve BER < 1×10^{-15} .

The programmable settings can be applied using the SMBus (I2C) interface, or they can be loaded via an external EEPROM. An on-chip eye monitor and a PRBS generator allow real-time measurement of high-speed serial data for system bring-up or field tuning. Flow-through pinout and single power supply make the DS100RT410 easy to use.

The device is offered in a RHS 48-pin, 7 mm x 7 mm package with flow-through pinout for the high speed signals.



Please be aware that an important notice concerning availability, standard warranty, and use in critical applications of Texas Instruments semiconductor products and disclaimers thereto appears at the end of this data sheet.

All trademarks are the property of their respective owners.

PRODUCTION DATA information is current as of publication date. Products conform to specifications per the terms of the Texas Instruments standard warranty. Production processing does not necessarily include testing of all parameters.

Copyright © 2013, Texas Instruments Incorporated

TYPICAL APPLICATION DIAGRAM

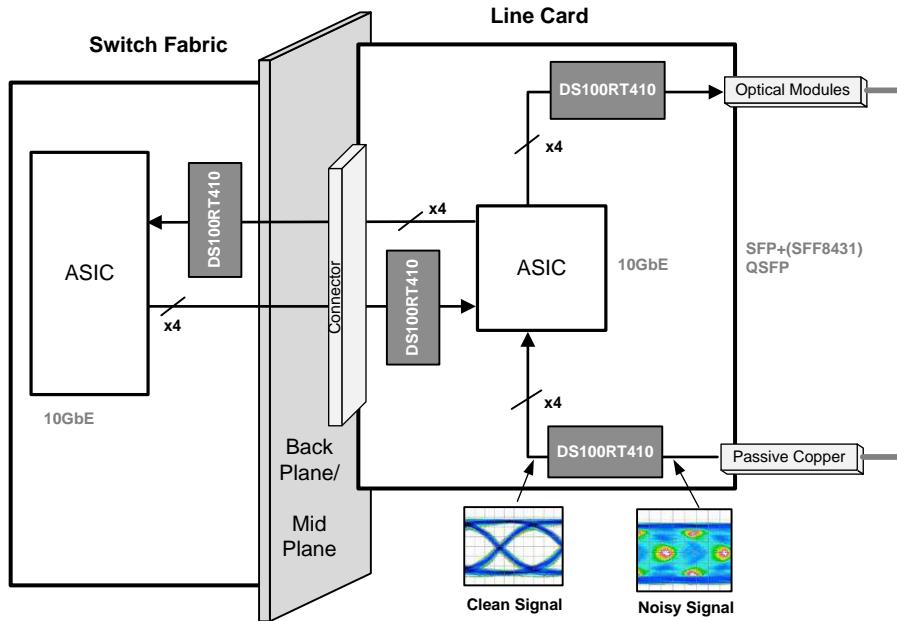

Connection Diagram

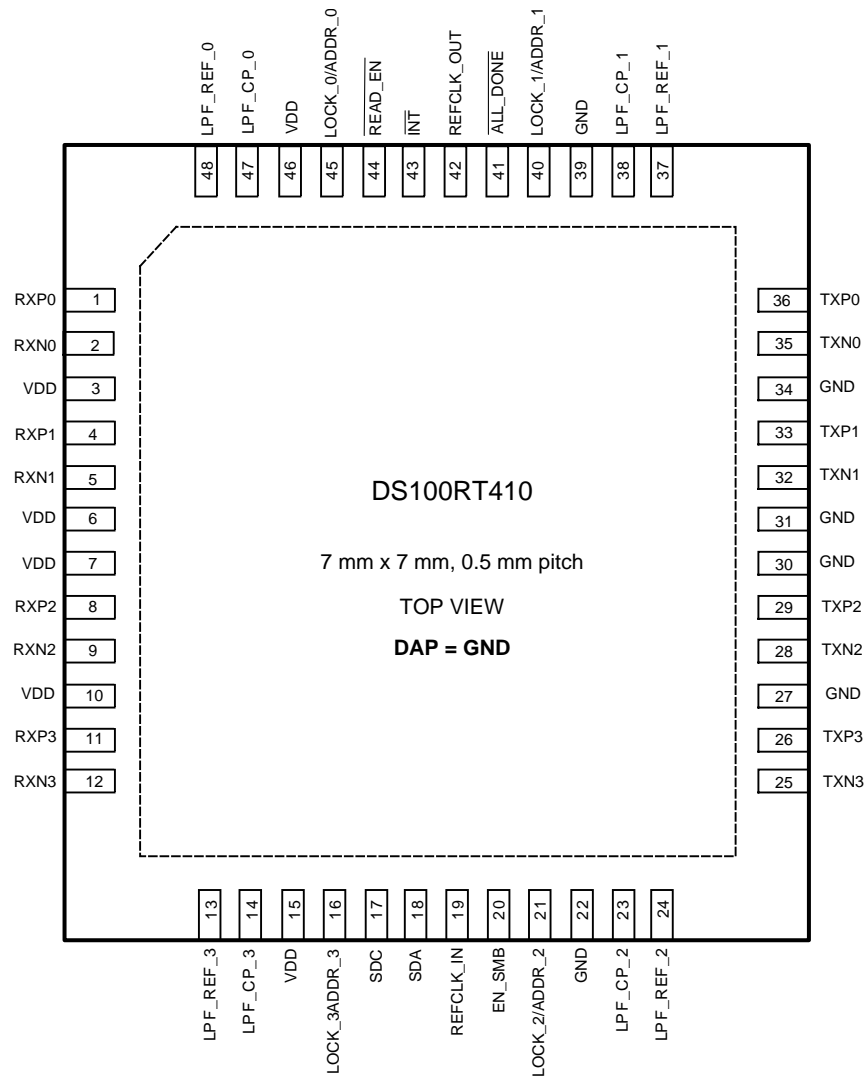

Pin Functions

Pin Descriptions

Pin Name	Pin #	I/O, Type ⁽¹⁾	Description
HIGH-SPEED DIFFERENTIAL I/O			
RXP0 RXN0	1 2	I, CML	Inverting and non-inverting CML-compatible differential inputs to the equalizer. Nominal differential input impedance = 100Ω.
RXP1 RXN1	4 5	I, CML	Inverting and non-inverting CML-compatible differential inputs to the equalizer. Nominal differential input impedance = 100Ω.
RXP2 RXN2	8 9	I, CML	Inverting and non-inverting CML-compatible differential inputs to the equalizer. Nominal differential input impedance = 100Ω.
RXP3 RXN3	11 12	I, CML	Inverting and non-inverting CML-compatible differential inputs to the equalizer. Nominal differential input impedance = 100Ω.
TXP0 TXN0	36 35	O, CML	Inverting and non-inverting CML-compatible differential outputs from the driver. Nominal differential output impedance = 100Ω.
TXP1 TXN1	33 32	O, CML	Inverting and non-inverting CML-compatible differential outputs from the driver. Nominal differential output impedance = 100Ω.
TXP2 TXN2	29 28	O, CML	Inverting and non-inverting CML-compatible differential outputs from the driver. Nominal differential output impedance = 100Ω.
TXP3 TXN3	26 25	O, CML	Inverting and non-inverting CML-compatible differential outputs from the driver. Nominal differential output impedance = 100Ω.
LOOP FILTER CONNECTION PINS			
LPF_CP_0 LPF_REF_0	47 48	I/O, analog	Loop filter connection Place a 22 nF ± 10% Capacitor between LPF_CP_0 and LPF_REF_0
LPF_CP_1 LPF_REF_1	38 37	I/O, analog	Loop filter connection Place a 22 nF ± 10% Capacitor between LPF_CP_1 and LPF_REF_1
LPF_CP_2 LPF_REF_2	23 24	I/O, analog	Loop filter connection Place a 22 nF ± 10% Capacitor between LPF_CP_2 and LPF_REF_2
LPF_CP_3 LPF_REF_3	14 13	I/O, analog	Loop filter connection Place a 22 nF ± 10% Capacitor between LPF_CP_3 and LPF_REF_3
REFERENCE CLOCK I/O			
REFCLK_IN	19	I, 2.5V analog	Input is 2.5 V, 25 MHz ± 100 ppm reference clock from external oscillator No stringent phase noise requirement
REFCLK_OUT	42	O, 2.5V analog	Output is 2.5 V, buffered replica of reference clock input for connecting multiple DS100RT410s on a board.
LOCK INDICATOR PINS			
LOCK_0 LOCK_1 LOCK_2 LOCK_3	45 40 21 16	O, 2.5V LVCMOS	Output is 2.5 V, the pin is high when CDR lock is attained on the corresponding channel. Note that these pins are shared with SMBus address strap input functions read at startup
SMBus MASTER MODE PINS			
ALL_DONE	41	O, 2.5V LVCMOS	Output is 2.5 V, the pin goes low to indicate that the SMBus master EEPROM read has been completed.
READ_EN	44	I, 2.5V LVCMOS	Input is 2.5 V, a transition from high to low starts the load from the external EEPROM. The READ_EN pin must be tied low when in SMBus slave mode.
INTERRUPT OUTPUT			
INT	43	O, 3.3V LVCMOS, Open Drain	Used to signal horizontal or vertical eye opening out of tolerance, loss of signal detect, or CDR unlock External 2KΩ to 5KΩ pull-up resistor is required. Pin is 3.3V LVCMOS tolerant.
SERIAL MANAGEMENT BUS (SMBus) INTERFACE			
EN_SMB	20	I, 2.5V analog	Input is 2.5 V, selects SMBus master mode or SMBus slave mode EN_SMB = High for slave mode EN_SMB = Float for master mode Tie READ_EN pin low for SMBus slave mode. See Table 1

(1) **Notes:**

I = Input, O = Output and 2.5V LVCMOS pins are 2.5 V levels only.

Only SMBus pins SDA and SDC and INT pin are 3.3 V tolerant. These pins are open-drain and require external pull-up resistors.

Pin Descriptions (continued)

Pin Name	Pin #	I/O, Type ⁽¹⁾	Description
SDA	18	I/O, 3.3V LVCMOS, Open Drain	Data Input / Open Drain Output External 2K Ω to 5K Ω pull-up resistor is required. Pin is 3.3V LVCMOS tolerant.
SDC	17	I/O, 3.3V LVCMOS, Open Drain	Clock Input / Open Drain Clock Output External 2K Ω to 5K Ω pull-up resistor is required. Pin is 3.3V LVCMOS tolerant.
ADDR_0	45	I, 2.5V LVCMOS	Input is 2.5 V, the ADDR_[3:0] pins set the SMBus address for the retimer. These pins are strap inputs. Their state is read on power-up to set the SMBus address in SMBus control mode. High = 1K Ω to V _{DD} , Low = 1K Ω to GND Note that these pins are shared with the LOCK pins (lock indicator functions). See Table 2
ADDR_1	40		
ADDR_2	21		
ADDR_3	16		
POWER			
V _{DD}	3, 6, 7, 10, 15, 46	Power	V _{DD} = 2.5 V \pm 5%
GND	22, 27, 30, 31, 34, 39	Power	Ground reference.
DAP	PAD	Power	Ground reference. The exposed pad at the center of the package must be connected to ground plane of the board with at least 4 vias to lower the ground impedance and improve the thermal performance of the package.



These devices have limited built-in ESD protection. The leads should be shorted together or the device placed in conductive foam during storage or handling to prevent electrostatic damage to the MOS gates.

Absolute Maximum Ratings⁽¹⁾

Supply Voltage (V _{DD})		-0.5V to +2.75V
2.5 I/O Voltage (LVCMOS and Analog)		-0.5V to +2.75V
3.3 LVCMOS I/O Voltage (SDA, SDC, INT)		-0.5V to +4.0V
Signal Input Voltage (RX _{Pn} , RX _{Nn})		-0.5V to +2.75V
Signal Output Voltage (TX _{Pn} , TX _{Nn})		-0.5V to +2.75V
Junction Temperature		+150°C
Storage Temperature		-65°C to +150°C
ESD Rating	HBM, STD - JESD22-A114F	\geq 6 kV
	MM, STD - JESD22-A115-A	\geq 250 V
	CDM, STD - JESD22-C101-D	\geq 1250 V
Thermal Resistance θ_{JA} , No Airflow, 4 layer JEDEC, 9 thermal vias		26.1 °C/W
For soldering specifications: see http://www.ti.com/lit/an/snoa549c/snoa549c.pdf		

- (1) "Absolute Maximum Ratings" indicate limits beyond which damage to the device may occur, including inoperability and degradation of device reliability and/or performance. Functional operation of the device and/or non-degradation at the Absolute Maximum Ratings or other conditions beyond those indicated in the Recommended Operating Conditions is not implied.

Recommended Operating Conditions⁽¹⁾

	Min	Typ	Max	Units
Supply Voltage (V _{DD} to GND)	2.375	2.5	2.625	V
Ambient Temperature	-40	25	+85	°C

- (1) The Recommended Operating Conditions indicate conditions at which the device is functional and the device should not be operated outside these conditions.

Electrical Characteristics

Over recommended operating supply and temperature ranges with default register settings unless otherwise specified. ⁽¹⁾

Symbol	Parameter	Conditions	Min	Typ	Max	Units
POWER						
PD	Power Supply Consumption	Average Power Consumption ⁽²⁾		600		mW
		Max Transient Power Supply Current ⁽³⁾		500	610	mA
NT _{PS}	Supply Noise Tolerance ⁽⁴⁾	50 Hz to 100 Hz		100		mV _{p-p}
		100 Hz to 10 MHz		40		mV _{p-p}
		10 MHz to 5.0 GHz		10		mV _{p-p}
2.5 V LVCMOS DC SPECIFICATIONS						
V _{IH}	High Level Input Voltage		1.75		V _{DD}	V
V _{IL}	Low Level Input Voltage		GND		0.7	V
V _{OH}	High Level Output Voltage	I _{OH} = -3mA	2.0			V
V _{OL}	Low Level Output Voltage	I _{OL} = 3mA			0.4	V
I _{IN}	Input Leakage Current	V _{IN} = V _{DD}			+10	μA
		V _{IN} = GND	-10			μA
I _{IH}	Input High Current (EN_SMB pin)	V _{IN} = V _{DD}		+55		μA
I _{IL}	Input Low Current (EN_SMB pin)	V _{IN} = GND		-110		μA
3.3 V LVCMOS DC SPECIFICATIONS (SDA, SDC, INT)						
V _{IH}	High Level Input Voltage	V _{DD} = 2.5 V	1.75		3.6	V
V _{IL}	Low Level Input Voltage	V _{DD} = 2.5 V	GND		0.7	V
V _{OL}	Low Level Output Voltage	I _{PULLUP} = 3mA			0.4	V
I _{IH}	Input High Current	V _{IN} = 3.6 V, V _{DD} = 2.5 V	+20		+40	μA
I _{IL}	Input Low Current	V _{IN} = GND, V _{DD} = 2.5 V	-10		+10	μA
f _{SDC}	SMBus clock rate		100		400	KHz
DATA BIT RATES						
R _B	Bit Rate Range	10.3125 Gbps Ethernet	10.1		10.6	Gbps
		1.25 Gbps Ethernet	1.2		1.3	Gbps
SIGNAL DETECT						
SDH	Signal Detect ON Threshold Level	Default differential input signal level to assert signal detect, 10.3125 Gbps, PRBS-31		70		mV _{p-p}
SDL	Signal Detect OFF Threshold Level	Default differential input signal level to de-assert signal detect, 10.3125 Gbps, PRBS-31		10		mV _{p-p}

- (1) Typical values represent most likely parametric norms at V_{DD} = 2.5V, T_A = 25°C., and at the Recommended Operation Conditions at the time of product characterization and are not guaranteed.
- (2) V_{DD} = 2.5V, T_A = 25°C. All four channels active and locked.
- (3) Maximum power supply current during lock acquisition. All four channels active, all four channels unlocked, all registers at default settings.
- (4) Allowed supply noise (mV_{p-p} sine wave) under typical conditions.

Electrical Characteristics (continued)

Over recommended operating supply and temperature ranges with default register settings unless otherwise specified. ⁽¹⁾

Symbol	Parameter	Conditions	Min	Typ	Max	Units
RECEIVER INPUTS (RXPn, RXNn)						
V _{TX2, min}	Minimum Source Transmit Launch Signal Level (IN, diff)	See ⁽⁵⁾		600		mV _{P-P}
V _{TX2, max}	Maximum Source Transmit Launch Signal Level (IN, diff)	See ⁽⁵⁾		1000		mV _{P-P}
V _{TX1, max}	Maximum Source Transmit Launch Signal Level (IN, diff)	See ⁽⁶⁾		1200		mV _{P-P}
V _{TX0, max}	Maximum Source Transmit Launch Signal Level (IN, diff)	See ⁽⁷⁾		1600		mV _{P-P}
L _{RI}	Maximum Differential Input Return Loss - SDD11	100 MHz – 6 GHz ⁽⁸⁾		-15		dB
Z _D	Differential Input Impedance	100 MHz – 6 GHz		100		Ω
Z _S	Single-ended Input Impedance	100 MHz – 6 GHz		50		Ω
DRIVER OUTPUTS (TXPn, TXNn)						
V _{OD0}	Differential output voltage	Differential measurement with OUT+ and OUT- terminated by 50Ω to GND, AC-Coupled, SMBus register VOD control (Register 0x2d bits 2:0) set to 0, minimum VOD De-emphasis control set to minimum (0 dB)	400		675	mV _{P-P}
V _{OD7}	Differential output voltage	Differential measurement with OUT+ and OUT- terminated by 50Ω to GND, AC-Coupled SMBus register VOD control (Register 0x2d bits 2:0) set to 7, maximum VOD De-emphasis control set to minimum (0 dB)	1000			mV _{P-P}
V _{OD_DE}	De-emphasis level ⁽⁹⁾	Differential measurement with OUT+ and OUT- terminated by 50Ω to GND, AC-Coupled Set by SMBus register control to maximum de-emphasis setting Relative to the nominal 0 dB de-emphasis level set at the minimum de-emphasis setting		-12		dB
t _R , t _F	Transition time (rise and fall times) ⁽⁹⁾ ⁽¹⁰⁾	Transition time control = Full Slew Rate		39		ps
		Transition time control = Limited Slew Rate		50		ps
L _{RO}	Maximum Differential Output Return Loss - SDD22	100 MHz – 6 GHz ⁽⁸⁾		-15		dB
t _{DP}	Propagation Delay	Retimed data ⁽¹¹⁾		300		ps
T _{DE}	De-emphasis pulse duration ⁽¹²⁾	Measured at V _{OD} = 1000 mV _{P-P} , de-emphasis setting = -12 dB		75		ps

(5) Differential signal amplitude at the transmitter output providing < 1x10⁻¹² bit error rate. Measured at 10.3125 Gbps with a PRBS-31 data pattern. Input transmission channel is 40-inch long FR-4 stripline, 4-mil trace width.

(6) Differential signal amplitude at the transmitter output providing < 1x10⁻¹² bit error rate. Measured at 10.3125 Gbps with a PRBS-31 data pattern. Input transmission channel is 30-inch long FR-4 stripline, 4-mil trace width.

(7) Differential signal amplitude at the transmitter output providing < 1x10⁻¹² bit error rate. Measured at 10.3125 Gbps with a PRBS-31 data pattern. No input transmission channel.

(8) Measured with 10 MHz clock pattern output.

(9) Measured with clock-like {11111 00000} pattern.

(10) Slew rate is controlled by SMBus register settings.

(11) Typical at 10.3125 Gbps bit rate.

(12) De-emphasis pulse width varies with V_{OD} and de-emphasis settings.

Electrical Characteristics (continued)

Over recommended operating supply and temperature ranges with default register settings unless otherwise specified. ⁽¹⁾

Symbol	Parameter	Conditions	Min	Typ	Max	Units
T _J	Output total jitter	Measured at BER = 10 ⁻¹² (13)		10		ps
T _{SKEW}	Intra Pair Skew	Difference in 50% crossing between TXP _n and TXN _n for any output		3		ps
CLOCK AND DATA RECOVERY						
BW _{PLL}	PLL Bandwidth -3 dB	Measured at 10.3125 Gbps		5		MHz
J _{TOL}	Input sinusoidal jitter tolerance 10 kHz to 250 MHz sinusoidal jitter frequency	Measured at BER = 10 ⁻¹⁵		0.6		UI
J _{TRANS}	Jitter Transfer Sinusoidal jitter at 10 MHz jitter frequency	Measured at BER = 10 ⁻¹⁵		-6		dB
T _{LOCK}	CDR Lock Time	Measured at 10.3125 Gbps		15		ms

(13) Typical with no output de-emphasis, minimum output transmission channel.

FUNCTIONAL DESCRIPTION

The DS100RT410 is a low-power 10GbE 4-channel retimer. Each of the four channels operates independently. Each channel includes a Continuous-Time Linear Equalizer (CTLE) which compensates for the presence of a dispersive transmission channel between the source and the DS100RT410's input.

Each channel includes an independent Voltage-Controlled Oscillator (VCO) and Phase-Locked Loop (PLL) which produce a clean clock. The clean clock produced by the VCO and the PLL is phase-locked to the incoming data clock and the high-frequency jitter on the incoming data is attenuated by the PLL, producing a clean clock with substantially reduced jitter. This clean clock is used to retime the incoming data, removing high-frequency jitter from the data stream and producing a data output signal with reduced jitter.

Each channel of the DS100RT410 features an output driver with programmable differential output voltage and output de-emphasis control. The output de-emphasis compensates for dispersion in the transmission channel at the output of the DS100RT410.

These three functions together make up the data path for the DS100RT410.

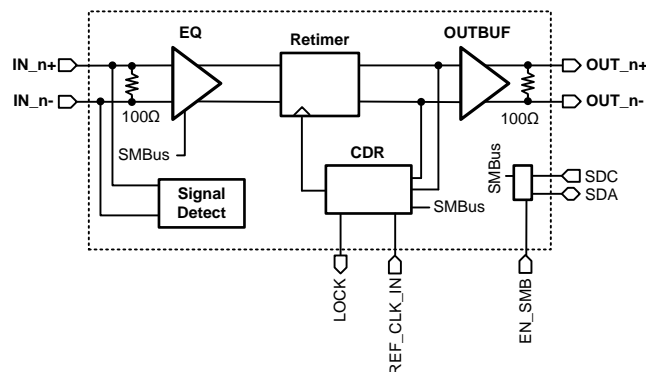

Figure 1. DS100RT410 Data Path Block Diagram — One of Four Channels

Device Data Path Operation

The data path operation of the DS100RT410 comprises three functional sections as shown in the data path block diagram of Figure 1. The three functional sections are as follows.

- Channel Equalization
- Clock and Data Recovery
- Output Driver

Channel Equalization

Physical transmission media such as traces on printed circuit boards (PCBs) or copper cables exhibit a low-pass frequency response characteristic. The magnitude of the high-frequency loss varies with the length of the transmission media and with the loss of the materials. This differential high-frequency loss and the frequency-dependent group delay of the transmission media introduce inter-symbol interference in the high-speed broadband signals propagating through the transmission media.

The DS100RT410 applies a frequency-response equalization function to the incoming data stream. The equalization function reduces the effect of the frequency-dependent loss in the transmission media between the transmitter output and the input of the DS100RT410. The DS100RT410 includes a Continuous Time Linear Equalizer or CTLE. The CTLE is designed to provide a controlled-amount of high-frequency boost to the signal in the frequency domain to compensate for the frequency-dependent loss in the transmission media.

The CTLE is a four-stage variable boost high-gain amplifier with a quasi-high-pass characteristic. Each of the four stages can be set to provide various amounts of high-frequency boost with the overall transfer function of the CTLE set by the cascade of all four sections. The high-frequency boost of each CTLE stage is variable. The optimum boost for each stage is one that causes the transfer function magnitude of the transmission channel and the CTLE in cascade to be flat over a band of frequencies extending up to half the data rate which is commonly referred to as the “Nyquist” frequency. In normal operation, the DS100RT410 sets the boost of the CTLE automatically to approximate the optimum cascaded response.

Clock and Data Recovery

The DS100RT410 performs its clock and data recovery function by detecting the bit transitions in the incoming data stream and locking its internal VCO to the clock represented by the mean arrival times of these bit transitions. This process produces a recovered clock with jitter which is greatly reduced for jitter frequencies outside the bandwidth of the CDR Phase-Locked Loop (PLL). This is the primary benefit of using the DS100RT410 in a system. It significantly reduces the jitter present in the data stream, in effect resetting the jitter budget for the system.

The DS100RT410 uses the 25 MHz reference to ensure the correct VCO frequency. The DS100RT410 uses the 25 MHz reference to initially determine the coarse tuning setting for its internal VCO. When the device is operated in this mode, on power-up, on CDR reset, and when the DS100RT410 loses lock, the 25 MHz reference is used to calibrate the VCO frequency. The required VCO frequency is set by using the PPM count and tolerance settings. To calibrate the VCO frequency, the DS100RT410 searches through the available VCO coarse tuning settings and counts the divided VCO frequency using the 25 MHz reference as a clock source. The VCO coarse tuning setting which provides the VCO frequency closest to the required frequency is stored, and this coarse tuning setting is used for subsequent operation. This produces a fast, robust phase lock to the input signal.

Output Driver

The DS100RT410 is commonly used in applications where lossy transmission media exist both at the input and the output of the DS100RT410. The CTLE compensates for lossy transmission media at the input to the DS100RT410. The output de-emphasis compensates for the lossy transmission media at the output of the DS100RT410.

When there is a transition in the output data stream, the output differential voltage reaches its configured maximum value within the configured rise/fall time of the output driver. Following this, the differential voltage rapidly falls off until it reaches the configured VOD level minus the configured de-emphasis level. This “pre-distortion” of the output signal accentuates the high-frequency components of the output signal at the expense of the low-frequency components. The pre-distorted signal, with its high-frequency components emphasized relative to its low-frequency components, travels down the dispersive transmission media at the output of the DS100RT410 with less inter-symbol interference than an undistorted signal would exhibit.

The output driver is capable of driving variable output voltages with variable amounts of analog de-emphasis. The output voltage and de-emphasis level can be configured by writing registers over the SMBus. The DS100RT410 cannot determine independently the appropriate output voltage or de-emphasis setting, so the user is responsible for configuring these parameters. They can be set for each channel independently.

An idealized transmit waveform with analog de-emphasis applied is shown in [Figure 2](#).

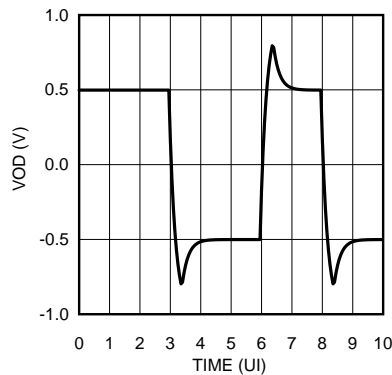

Figure 2. Idealized De-Emphasis Waveform

DEVICE CONFIGURATION INFORMATION

The DS100RT410 can be configured by the user to optimize its operation. The four channels can be optimized independently in SMBus master or SMBus slave mode. The operational settings available for user configuration include the following.

- CTLE boost setting
- Driver output voltage
- Driver output de-emphasis
- Driver output rise/fall time

Configuration of the DS100RT410 is accomplished by writing the appropriate values into various device registers over the SMBus. This can either be done while the device is operating or upon initial power-up. When the DS100RT410 is operating it behaves like an SMBus slave device, and its register contents can be read or written over the SMBus. Optionally, when the DS100RT410 first powers up, it can behave like an SMBus master and read its register contents autonomously from an external EEPROM.

CTLE Boost Setting

The CTLE is a four-stage amplifier with an adjustable, quasi-high-pass transfer function on each stage. The overall frequency response of the CTLE is set by adjusting the boost of each stage independently. Each stage of the CTLE can be set to one of four boost settings. The amount of high-frequency boost supplied by each stage generally increases with increasing boost settings.

The CTLE can also be configured to adapt automatically to provide the optimum boost level for its input signal. Automatic adaptation of the CTLE only is the default mode of operation for the DS110DF410.

Driver Output Voltage

The differential output voltage of the DS100RT410 can be configured from a nominal setting of 600 mV peak-to-peak differential to a nominal setting of 1.3 V peak-to-peak differential, depending upon the application. The driver output voltage as set is the typical peak-to-peak differential output voltage with no de-emphasis enabled.

Driver Output De-Emphasis

The output de-emphasis level of the DS100RT410 can be configured from a nominal setting of 0 dB to a nominal setting of -12 dB depending upon the application. Larger absolute values of the de-emphasis setting provide more pre-distortion of the output driver waveform, accentuating the high-frequency components of the output driver waveform relative to the low-frequency components. Greater values of de-emphasis can compensate for greater dispersion in the transmission media at the output of the DS100RT410. The output de-emphasis level as set is the typical value to which the output signal will settle following the de-emphasis pulse interval in dB relative to the output VOD.

Driver Output Rise/Fall Time

In some applications, a longer rise/fall time for the output signal is desired. This can reduce electromagnetic interference (EMI) generated by fast switching waveforms. This is necessary in some applications for regulatory compliance. In others, it can reduce the crosstalk in the system.

The DS100RT410 can be configured to operate with a nominal rise/fall time corresponding to the maximum slew rate of the output drivers into the load capacitance. Alternatively, the DS100RT410 can be configured to operate with a slightly greater rise/fall time if desired. For the typical specifications on rise/fall time, see [Electrical Characteristics](#)

If any interrupt occurs, registers in the DS100RT410 latch in information about the event that caused the interrupt. This can then be read out by the controller over the SMBus.

Ref_mode 0 Mode (reference clock not required)

The DS100RT410 can be used without using a reference clock and the input REFCLK_IN pin can be open. When register 0x36, bits [5:4] are set to 2'b00, the device operates without using a reference clock at 10.3125 Gbps mode.

For 1GbE applications, it is required to bypass the CDR by setting the override bit 5 of register 0x09 to 1, and set the data mux bits [7:5] to 3'b000 of register 0x1E.

Ref_mode 3 Mode (reference clock required)

When using ref_mode 3, the device uses an external 25 MHz clock. This mode of operation is set in register 0x36 bits [5:4] = 2'b11 and is the default setting. In ref_mode 3, the external reference clock is used to aid initial phase lock, and to determine when its VCO is properly phase-locked. An external oscillator should be used to generate a 2.5V, 25 MHz reference signal which is connected to the DS100RT410 on the reference clock input pin (pin 19). The DS100RT410 does not include a crystal oscillator circuit, so a stand-alone external oscillator is required.

The reference clock speeds up the initial phase lock acquisition. The DS100RT410 is set to phase lock to a known data rate, or a constrained set of known data rates, and the digital circuitry in the DS100RT410 pre-configures the VCO frequency. This enables the DS100RT410 phase-lock to the incoming signal very quickly.

The reference clock is used to calibrate the VCO coarse tuning. However, the reference clock is not synchronous to the data stream, and the quality of the reference clock does not affect the jitter on the output retimed data. The retimed data clock for each channel is synchronous to the VCO internal to that channel of the DS100RT410.

The phase noise of the reference clock is not critical. Any commercially-available 25 MHz oscillator can provide an acceptable reference clock. The reference clock can be daisy-chained from one retimer to another so that only one reference oscillator is required in a system.

False Lock Detector Setting

The register 0x2F, bit 1 is set to 1 by default, which disables the false lock detector. This bit must be set to 0 to enable the false lock detector function.

Reference Clock In

REFCLK_IN pin 19 is for reference clock input. A 25 MHz oscillator should be connected to pin 19. See [Electrical Characteristics](#) for the requirements on the 25 MHz clock. The frequency of the reference clock should always be 25 MHz no matter what data rate or mode of operation is used.

Reference Clock Out

REFCLK_OUT pin 42 is the reference clock output pin. The DS100RT410 drives a buffered replica of the 25 MHz reference clock input on this output pin. If there are multiple DS100RT410 in the system, the REFCLK_OUT pin can be directly connected to the REFCLK_IN pin of another DS100RT410 in a daisy chain connection. The other option is to connect the external 25 MHz oscillator to a clock fanout buffer to distribute the 25 MHz clock to each DS100RT410, which ensures there is a reference clock for the DS100RT410.

$\overline{\text{INT}}$

The $\overline{\text{INT}}$ line is an open-drain, 3.3V tolerant, LVCMOS active-low output. The $\overline{\text{INT}}$ lines from multiple DS100RT410s can be wired together and connected to an external controller.

The DS100RT410 generates an interrupt when it detects a loss of signal after previously detecting the presence of a signal, or when it detects loss of lock after previously detecting phase lock. These interrupts are always enabled. In addition, the Horizontal Eye Opening/Vertical Eye Opening (HEO/VEO) interrupt can be enabled using SMBus control for each channel independently. This interrupt is disabled by default. The thresholds for horizontal and vertical eye opening that will trigger the interrupt can be set using the SMBus control for each channel.

LOCK_3, LOCK_2, LOCK_1, and LOCK_0

Each channel of the DS100RT410 has an independent lock indication pin. These lock indication pins, LOCK_3, LOCK_2, LOCK_1, and LOCK_0, are pin 16, pin 21, pin 40, and pin 45 respectively. These pins are shared with the SMBus address strap lines. After the address values have been latched in on power-up, these lines revert to their lock indication function.

When the corresponding channel of the DS100RT410 is locked to the incoming data stream, the lock indication pin goes high. This pin can be used to drive an LED on the board, giving a visual indication of the lock status, or it can be connected to other circuitry which can interpret the lock status of the channel.

DEVICE CONFIGURATION MODES

The DS100RT410 can be configured using two different methods.

- SMBus Master Configuration Mode
- SMBus Slave Configuration Mode

The configuration mode is selected by the state of the EN_SMB pin (pin 20) when the DS100RT410 is powered-up. This pin should be either left floating or tied to the device V_{DD} through an optional 1K Ω resistor. The effect of each of these settings is shown in [Table 1](#).

Table 1. SMBus Enable Settings

EN_SMB Pin Setting	Configuration Mode	Description	READ_EN Pin
Float	SMBus Master Mode	Device reads its configuration from an external EEPROM on power-up	Pull low to initiate reading configuration data from external EEPROM
High (1)	SMBus Slave Mode	Device is configured over the SMBus by an external controller	Tie low to enable proper address strapping on power-up

SMBus Master Mode and SMBus Slave Mode

In SMBus master mode the DS100RT410 reads its initial configuration from an external EEPROM upon power-up. A description of the operation of this mode appears in a separate application note.

Some of the pins of the DS100RT410 perform the same functions in SMBus master and SMBus slave mode. Once the DS100RT410 has finished reading its initial configuration from the external EEPROM in SMBus master mode it reverts to SMBus slave mode and can be further configured by an external controller over the SMBus. Two device pins initiate reading the configuration from the external EEPROM and indicate when the configuration read is complete.

- ALL_DONE
- READ_EN

These pins are meant to work together. When the DS100RT410 is powered up in SMBus master mode, it reads its configuration from the external EEPROM. This is triggered when the READ_EN pin goes low. When the DS100RT410 is finished reading its configuration from the external EEPROM, it drives its ALL_DONE pin low. In this mode, as the name suggests, the DS100RT410 acts as an SMBus master during the time it is reading its configuration from the external EEPROM. After the DS100RT410 has finished reading its configuration from the EEPROM, it releases control of the SMBus and becomes a SMBus slave. In applications where there is more than one DS100RT410 on the same SMBus, bus contention can result if more than one DS100RT410 tries to take command of the SMBus as the SMBus master at the same time. The READ_EN and ALL_DONE pins prevent this bus contention.

In a system where the DS100RT410s are meant to operate in SMBus master mode, the READ_EN pin of one retimer should be wired to the ALL_DONE pin of the next. The system should be designed so that the READ_EN pin of one (and only one) of the DS100RT410s in the system is driven low on power-up. This DS100RT410 will take command of the SMBus on power-up and will read its initial configuration from the external EEPROM. When it is finished reading its configuration, it will set its ALL_DONE pin low. This pin should be connected to the READ_EN pin of another DS100RT410. When this DS100RT410 senses its READ_EN pin driven low, it will take command of the SMBus and read its initial configuration from the external EEPROM, after which it will set its ALL_DONE pin low. By connecting the ALL_DONE pin of each DS100RT410 to the READ_EN pin of the next DS100RT410, each DS100RT410 can read its initial configuration from the EEPROM without causing bus contention.

For SMBus slave mode, the READ_EN pin **must be tied low**. Do not leave it floating or tie it high.

A connection diagram showing several DS100RT410s along with an external EEPROM and an external SMBus master is shown in [Figure 3](#).

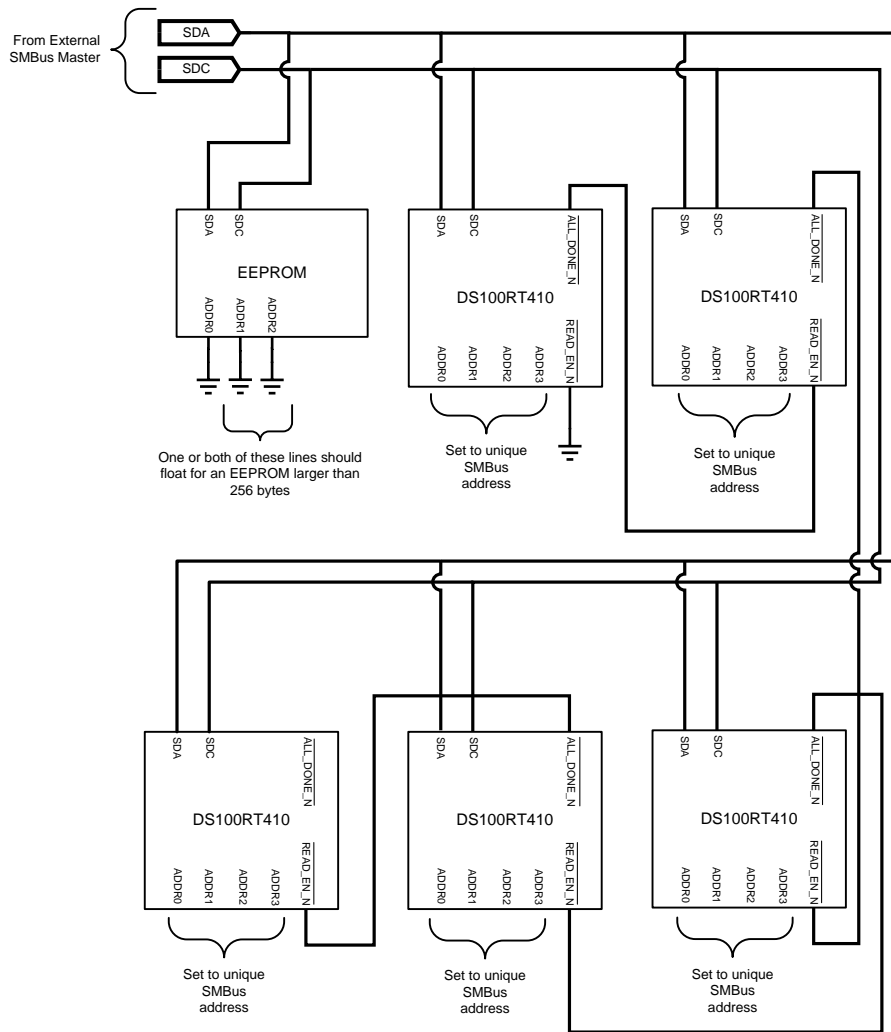

Figure 3. Connection Diagram for Multiple DS100RT410s in SMBus Master Mode

In SMBus master mode after the DS100RT410 has finished reading its initial configuration from the external EEPROM it reverts to SMBus slave mode. In either mode the SMBus data and clock lines, SDA and SDC, are used. Also, in either mode, the SMBus address is latched in on the address strap lines on power-up. In SMBus slave mode, if the `READ_EN` pin is not tied low, the DS100RT410 will not latch in the address on its address strap lines. It will instead latch in an SMBus write address of 0x30 regardless of the state of the address strap lines. This is a test feature. Obviously a system with multiple retimers cannot operate properly if all the retimers are responding to the same SMBus address. Tie the `READ_EN` pin low when operating in SMBus slave mode to avoid this condition.

The DS100RT410 reads its SMBus address upon power-up from the SMBus address lines.

Address Lines <ADDR_[3:0]>

In either SMBus master or SMBus slave mode the DS100RT410 must be assigned an SMBus address. A unique address must be assigned to each device on the SMBus.

The SMBus address is latched into the DS100RT410 on power-up. The address is read in from the state of the <ADDR_[3:0]> lines (pins 16, 21, 40, and 45 respectively) upon power-up. In either SMBus mode these address lines are input pins on power-up.

The DS100RT410 can be configured with any of 16 SMBus addresses. The SMBus addressing scheme uses the least-significant bit of the SMBus address as the Read/Write_N address bit. When an SMBus device is addressed for writing, this bit is set to 0; for reading, to 1. Table 2 below shows the write address setting for the DS100RT410 versus the values latched in on the address lines at power-up.

The address byte sent by the SMBus master over the SMBus is always 8 bits long. The least-significant bit indicates whether the address is for a write operation, in which the master will output data to the SMBus to be read by the slave, or a read operation, in which the slave will output data to the SMBus to be read by the master. If the least-significant bit is a 0, the address is for a write operation. If it is a 1, the address is for a read operation. Accordingly, SMBus addresses are sometimes referred to as seven-bit addresses. To produce the write address for the SMBus, the seven-bit address is left-shifted by one bit. To produce the read address, it is left shifted by one bit and the least-significant bit is set to 1. Table 2 shows the seven-bit addresses corresponding to each set of address line values.

When the DS100RT410 is used in SMBus slave mode, the $\overline{\text{READ_EN}}$ pin must be tied low. If it is tied high or floating, the DS100RT410 will not latch in its address from the address lines on power-up. When the $\overline{\text{READ_EN}}$ pin is tied high in SMBus slave mode *i.e.* when the EN_SMB pin (pin 20) is tied high, the DS100RT410 will revert to an SMBus write address of 0x30. This is a test feature. If there are multiple DS100RT410s on the same SMBus, they will all revert to an SMBus write address of 0x30, which can cause SMBus collisions and failure to access the DS100RT410s over the SMBus.

Table 2. DS100RT410 SMBus Write Address Assignment

ADDR_3	ADDR_2	ADDR_1	ADDR_0	SMBus Write Address	Seven-bit SMBus Address
0	0	0	0	0x30	0x18
0	0	0	1	0x32	0x19
0	0	1	0	0x34	0x1a
0	0	1	1	0x36	0x1b
0	1	0	0	0x38	0x1c
0	1	0	1	0x3a	0x1d
0	1	1	0	0x3c	0x1e
0	1	1	1	0x3e	0x1f
1	0	0	0	0x40	0x20
1	0	0	1	0x42	0x21
1	0	1	0	0x44	0x22
1	0	1	1	0x46	0x23
1	1	0	0	0x48	0x24
1	1	0	1	0x4a	0x25
1	1	1	0	0x4c	0x26
1	1	1	1	0x4e	0x27

Once the DS100RT410 has latched in its SMBus address, its registers can be read and written using the two pins of the SMBus interface, Serial Data (SDA) and Serial Data Clock (SDC).

SDA and SDC

In both SMBus master and SMBus slave mode, the DS100RT410 is configured using the SMBus. The SMBus consists of two lines, the SDA or Serial Data line (pin 18) and the SDC or Serial Data Clock line (pin 17). In the DS100RT410 these pins are 3.3V tolerant. The SDA and SDC lines are both open-drain. They require a pull-up resistor to a supply voltage, which may be either 2.5V or 3.3V. A pull-up resistor in the 2K Ω to 5K Ω range will provide reliable SMBus operation.

The SMBus is a standard communications bus for configuring simple systems. For a specification of the SMBus an description of its operation, see <http://smbus.org/specs/>.

REGISTER INFORMATION

There are two types of device registers in the DS100RT410. These are the control/shared registers and the channel registers. The control/shared registers control or allow observation of settings which affect the operation of all channels of the DS100RT410. They are also used to select which channel of the device is to be the target channel for reads from and writes to the channel registers.

The channel registers are used to set all the configuration settings of the DS100RT410. They provide independent control for each channel of the DS100RT410 for all the settable device characteristics.

Any registers not described in the tables that follow should be treated as reserved. The user should not try to write new values to these registers. The user-accessible registers described in the tables that follow provide a complete capability for customizing the operation of the DS100RT410 on a channel-by-channel basis.

Bit Fields in the Register Set

Many of the registers in the DS100RT410 are divided into bit fields. This allows a single register to serve multiple purposes, which may be unrelated.

Often configuring the DS100RT410 requires writing a bit field that makes up only part of a register value while leaving the remainder of the register value unchanged. The procedure for accomplishing this is to read in the current value of the register to be written, modify only the desired bits in this value, and write the modified value back to the register. Of course, if the entire register is to be changed, rather than just a bit field within the register, it is not necessary to read in the current value of the register first.

In all the register configuration procedures described in the following sections, this procedure should be kept in mind. In some cases, the entire register is to be modified. When only a part of the register is to be changed, however, the procedure described above should be used.

Writing to and Reading from the Control/Shared Registers

Any write operation targeting register 0xff writes to the control/shared register 0xff. This is the only register in the DS100RT410 with an address of 0xff.

Bit 2 of register 0xff is used to select either the control/shared register set or a channel register set. If bit 2 of register 0xff is cleared (written with a 0), then all subsequent read and write operations over the SMBus are directed to the control/shared register set. This situation persists until bit 2 of register 0xff is set (written with a 1).

There is a register with address 0x00 in the control/shared register set, and there is also a register with address 0x00 in each channel register set. If you read the value in register 0x00 when bit 2 of register 0xff is cleared to 0, then the value returned by the DS100RT410 is the value in register 0x00 of the control/shared register set. If you read the value in register 0x00 when bit 2 of register 0xff is set to 1, then the value returned by the DS100RT410 is the value in register 0x00 of the selected channel register set. The channel register set is selected by bits 1:0 of register 0xff.

If bit 3 of register 0xff is set to 1 and bit 2 of register 0xff is also set to 1, then any write operation to any register address will write all the channel register sets in the DS100RT410 simultaneously. This situation will persist until either bit 3 of register 0xff or bit 2 of register 0xff is cleared. Note that when you write to register 0xff, independent of the current settings in register 0xff, the write operation **ALWAYS** targets the control/shared register 0xff. This channel select register, register 0xff, is unique in this regard.

Table 3 below shows the control/shared register set. Any register addresses or register bits in the control/shared register set not shown in this table should be considered reserved. In this table, the mode is either R for Read-Only, R/W for Read-Write, or R/W/SC for Read-Write-Self-Clearing. If you try to write to a Read-Only register, the DS100RT410 will ignore it.

Table 3. Control/Shared Registers

Address (Hex)	Bits	Default Value (Hex)	Mode	Description
0x00	7:4	0x0	R	SMBus Address Strap Observation <3:0>
0x01	7:5	0x6	R	Device Revision
	4:0	0x10	R	Device ID
0x04	6	0x0	R/W/SC	Self-Clearing Reset for Control/Shared Registers
	5	0x0	R/W	Reset for SMBus Master Mode
	4	0x0	R/W	Force EEPROM Configuration
0x05	7	0x0	R/W	Disable Master Mode EEPROM Configuration
	4	(1)	R	EEPROM Read Complete
	3	0x0	R	Set on Channel 0 Interrupt
	2	0x0	R	Set on Channel 1 Interrupt
	1	0x0	R	Set on Channel 2 Interrupt
	0	0x0	R	Set on Channel 3 Interrupt
0x06	3:0	0x0	R/W	Diagnostic Test Control Set to 0xa to read SMBus strap values from register 0x00
0xff	3	0x0	R/W	Selects All Channels for Register Write See Table 4
	2	0x0	R/W	Enables Register Write to One or All Channels and Register Read from One Channel See Table 4
	1:0	0x0	R/W	Selects Target Channel for Register Reads and Writes See Table 4

(1) There is no default value. This bit always indicates whether the EEPROM read is complete or not.

SMBus Strap Observation

Register 0x00, bits 7:4 and register 0x06, bits 3:0

In order to communicate with the DS100RT410 over the SMBus, it is necessary for the SMBus controller to know the address of the DS100RT410. The address strap observation bits in control/shared register 0x00 are primarily useful as a test of SMBus operation. There is no way to get the DS100RT410 to tell you what its SMBus address is unless you already know what it is.

In order to use the address strap observation bits of control/shared register 0x00, it is necessary first to set the diagnostic test control bits of control/shared register 0x06. This four-bit field should be written with a value of 0xa. When this value is written to bits 3:0 of control/shared register 0x06, then the value of the SMBus address straps can be read in register 0x00, bits 7:4. The value read will be the same as the value present on the ADDR3:ADDR0 lines when the DS100RT410 was powered up. For example, if a value of 0x1 is read from control/shared register 0x00, bits 7:4, then at power-up the ADDR0 line was set to 1 and the other address lines, ADDR3:ADDR1, were all set to 0. The DS100RT410 is set to an SMBus Write address of 0x32.

Device Revision and Device ID

Register 0x01

Control/shared register 0x01 contains the device revision and device ID. The device revision shown in [Table 3](#) is the current revision for the DS100RT410. The device ID will be different for the different devices in the retimer family. The value shown in "For the DS100RT410, Register 0x01, bits 4:0 = 0x10" is the correct value for the DS100RT410. This register is useful because it can be interrogated by software to determine the device variant and revision installed in a particular system. The software might then configure the device with appropriate settings depending upon the device variant and revision.

Control/Shared Register Reset

Register 0x04, bit 6

Register 0x04, bit 6, clears all the control/shared registers back to their factory defaults. This bit is self-clearing, so it is cleared after it is written and the control/shared registers are reset to their factory default values.

Interrupt Channel Flag Bits

Register 0x05, bits 3:0

Register 0x05, bits 3:0 can be used to read which channel caused the $\overline{\text{INT}}$ interrupt signal to go low. When one of the four bits is set to 1 in this register, the channel associated with the bit has fallen out of CDR lock or because the input signal is no longer detected.

SMBus Master Mode Control Bits

Register 0x04, bits 5 and 4 and register 0x05, bits 7 and 4

Register 0x04, bit 5, can be used to reset the SMBus master mode. This bit should not be set if the DS100RT410 is in SMBus slave mode. This is an undefined condition.

When this bit is set, if the EN_SMB pin is floating (meaning that the DS100RT410 is in SMBus master mode), then the DS100RT410 will read the contents of the external EEPROM when the READ_EN pin is pulled low. This bit is not self-clearing, so it should be cleared after it is set.

When the DS100RT410 EN_SMB pin is floating (meaning that the DS100RT410 is in SMBus master mode), it will read from its external EEPROM when its READ_EN pin goes low. After the EEPROM read operation is complete, register 0x05, bit 4 will be set. Alternatively, the DS100RT410 will read from its external EEPROM when triggered by register 0x04, bit 4, as described below.

When register 0x04, bit 4, is set, the DS100RT410 reads its configuration from an external EEPROM over the SMBus immediately. When this bit is set, the DS100RT410 does not wait until the $\overline{\text{READ_EN}}$ pin is pulled low to read from the EEPROM. This EEPROM read occurs whether the DS100RT410 is in SMBus master mode or not. If the read from the EEPROM is not successful, for example because there is no EEPROM present, then the DS100RT410 may hang up and a power-up reset may be necessary to return it to proper operation. You should only set this bit if you know that the EEPROM is present and properly configured.

If the EEPROM read has already completed, then setting register 0x04, bit 4, will not have any effect. To cause the DS100RT410 to read from the EEPROM again it is necessary to set bit 5 of register 0x04, resetting the SMBus master mode. If the DS100RT410 is not in SMBus master mode, do not set this bit. After setting this bit, it should be cleared before further SMBus operations.

After SMBus master mode has been reset, the EEPROM read may be initiated either by pulling the $\overline{\text{READ_EN}}$ pin low or by then setting register 0x04, bit 4.

Register 0x05, bit 7, disables SMBus master mode. This prevents the DS100RT410 from trying to take command of the SMBus to read from the external EEPROM. Obviously this bit will have no effect if the EEPROM read has already taken place. It also has no effect if an EEPROM read is currently in progress. The only situations in which disabling EEPROM master mode read is valid are (1) when the DS100RT410 is in SMBus master mode, but the READ_EN pin has not yet gone low, and (2) when register 0x04, bit 5, has been used to reset SMBus master mode but the EEPROM read operation has not yet occurred.

Do not set this bit and bit 4 of register 0x04 simultaneously. This is an undefined condition and can cause the DS100RT410 to hang up.

Channel Select Register

Register 0xff, bits 3:0

Register 0xff, as described above, selects the channel or channels for channel register reads and writes. It is worth describing the operation of this register again for clarity. If bit 3 of register 0xff is set, then any channel register write applies to all channels. Channel register read operations always target only the channel specified in bits 1:0 of register 0xff regardless of the state of bit 3 of register 0xff. Read and write operations target the channel register sets only when bit 2 of register 0xff is set.

Bit 2 of register 0xff is the universal channel register enable. This bit must be set in order for any channel register reads and writes to occur. If this bit is set, then read operations from or write operations to register 0x00, for example, target channel register 0x00 for the selected channel rather than the control/shared register 0x00. In order to access the control/shared registers again, bit 2 of register 0xff should be cleared. Then the control/shared registers can again be accessed using the SMBus. Write operations to register 0xff always target the register with address 0xff in the control/shared register set. There is no other register, and specifically, no channel register, with address 0xff.

The contents of the channel select register, register 0xff, cannot be read back over the SMBus. Read operations on this register will always yield an invalid result. All eight bits of this register should always be set to the desired values whenever this register is written. Always write 0x0 to the four MSBs of register 0xff. The register set target selected by each valid value written to the channel select register is shown in [Table 4](#)

Table 4. Channel Select Register Values Mapped to Register Set Target

Register 0xff Value (hex)	Shared/Channel Register Selection	Broadcast Channel Register Selection	Targeted Channel Selection	Comments
0x00	Shared	N/A	N/A	All reads and writes target shared register set
0x04	Channel	No	0	All reads and writes target channel 0 register set
0x05	Channel	No	1	All reads and writes target channel 1 register set
0x06	Channel	No	2	All reads and writes target channel 2 register set
0x07	Channel	No	3	All reads and writes target channel 3 register set
0x0c	Channel	Yes	0	All writes target all channel register sets, all reads target channel 0 register set
0x0d	Channel	Yes	1	All writes target all channel register sets, all reads target channel 1 register set
0x0e	Channel	Yes	2	All writes target all channel register sets, all reads target channel 2 register set
0x0f	Channel	Yes	3	All writes target all channel register sets, all reads target channel 3 register set

Reading to and Writing from the Channel Registers

Each of the four channels has a complete set of channel registers associated with it. The channel registers or the control/shared registers are selected by channel select register 0xff. The settings in this register control the target for subsequent register reads and writes until the contents of register 0xff are explicitly changed by a register write to register 0xff. As noted, there is only one register with an address of 0xff, the channel select register.

Table 5. Channel Registers

Address (Hex)	Bits	Default Value (Hex)	Mode	Field Name	Description
0x00	2	0x0	R/W/SC	rst_regs	Reset Channel Registers to Defaults (Self-clearing)
0x01	4	0x0	R	cdr_lock_loss_int	CDR Lock Loss Interrupt
	0	0x0	R	signal_detect_loss_int	Signal Detect Loss Interrupt
0x03	7:6	0x0	R/W	eq_BST0[1:0]	CTLE Boost Stage 0 <1:0>
	5:4	0x0	R/W	eq_BST1[1:0]	CTLE Boost Stage 1 <1:0>
	3:2	0x0	R/W	eq_BST2[1:0]	CTLE Boost Stage 2 <1:0>
	1:0	0x0	R/W	eq_BST3[1:0]	CTLE Boost Stage 3 <1:0>
0x08	4:0	0x00	R/W	cdr_cap_dac_start[4:0]	Override Starting VCO Cap DAC Setting 0 <4:0>
0x09	7	0x0	R/W	reg_divsel_vco_cap_0v	Enable Override VCO Cap DAC (Registers 0x08 and 0x0b)
	5	0x0	R/W	reg_bypass_pfd_ov	Enable Override Output Mux (Register 0x1e)
	2	0x0	R/W	reg_divsel_ov	Enable Override Divider Select (Register 0x18)
0x0a	3	0x0	R/W	reg_cdr_reset_ov	Enable CDR Reset Override (Register 0x0a)
	2	0x0	R/W	reg_cdr_reset_sm	CDR Reset Override Bit
0x0b	4:0	0x0f	R/W	cdr_cap_dac_start1[4:0]	Override VCO Cap DAC Setting 1 <4:0>
0x0d	5	0x0	R/W	PRBS_PATT_SHIFT_EN	PRBS Generator Clock Enable
0x11	7:6	0x0	R/W	eom_sel_vrange[1:0]	Eye Opening Monitor Voltage Range <1:0>
	5	0x1	R/W	eom_PD	Eye Opening Monitor Power Down
0x13	2	0x0	RW	eq_BST3[2]	CTLE Boost Stage 3, Bit 2 (Limiting Bit)
0x14	7	0x0	R/W	eq_sd_preset	Force Signal Detect On
	6	0x0	R/W	eq_sd_reset	Force Signal Detect Off
0x15	6	0x0	R/W	drv_dem_range	Driver De-emphasis Range
	2:0	0x0	R/W	drv_dem[2:0]	Driver De-emphasis Setting <2:0>
0x18	6:4	0x4	R/W	pdiq_sel_div[2:0]	VCO Divider Ratio <2:0> (Enable from Register 0x09, Bit 2)
	2	0x0	R/W	drv_sel_slow	Enable Slow Rise/Fall Time on Output Driver

Table 5. Channel Registers (continued)

Address (Hex)	Bits	Default Value (Hex)	Mode	Field Name	Description
0x1e	7:5	0x7	R/W	pdf_sel_data_mux[2:0]	OutputMux <2:0> (Enable from Register 0x09, Bit 5)
	4	0x0	R/W	prbs_en	Enable PRBS Generator
0x1f	7	0x0	R/W	drv_sel_inv	Select Output Polarity Inverted
0x24	7	0x0	R/W	fast_eom	Enable Fast Eye Opening Monitor Mode
	0	0x0	R/W/SC	eom_start	Start Eye Opening Monitor Counter (Self-Clearing)
0x25	7:0	0x0	R	eom_count[15:8]	Eye Opening Monitor Count <15:8>
0x26	7:0	0x0	R	eom_count[7:0]	Eye Opening Monitor Count <7:0>
0x27	7:0	0x0	R	heo[7:0]	HEO Value <7:0>
0x28	7:0	0x0	R	veo[7:0]	VEO Value <7:0>
0x29	6:5	0x0	R	eom_vrange_setting[1:0]	Eye Opening Monitor Voltage Range Setting <1:0>
0x2a	7:0	0x30	R/W	eom_timer_thr[7:0]	Eye Opening Monitor Timer Threshold <7:0>
0x2d	2:0	0x0	R/W	drv_sel_vod[2:0]	Driver VOD <2:0>
0x2f	7:6	0x0	R/W	RATE[1:0]	Rate <1:0>
	5:4	0x0	R/W	SUBRATE[1:0]	Subrate <1:0>
	3	0x0	R/W	index_ov	CTLE Adaptation Index Override (Register 0x13)
	2	0x1	R/W	en_ppm_check	Enable Frequency Counter for Lock Detect
	1	0x1	R/W	en_fld_check	False Lock Detector for lock detect is disabled by default. Must set bit to 0 to enable the FLD.
	0	0x0	R/W	ctle_adapt	Start CTLE Adaptation
0x30	4	0x0	R	heo_veo_interrupt	Goes High if Interrupt from CDR Goes High
	3	0x0	R/W	prbs_en_dig_clk	PRBS Generator Enable
	1:0	0x0	R/W	prbs_pattern_sel[1:0]	PRBS Generator Pattern Select <1:0>
0x31	6:5	0x1	R/W	adapt_mode[1:0]	Adaptation Mode <1:0>
	4:3	0x0	R/W	eq_sm_fom[1:0]	CTLE Adaptation Figure of Merit Type <1:0>
0x32	7:4	0x1	R/W	heo_int_thresh[3:0]	HEO Interrupt Threshold <3:0>
	3:0	0x1	R/W	veo_int_thresh[3:0]	VEO Interrupt Threshold <3:0>

Table 5. Channel Registers (continued)

Address (Hex)	Bits	Default Value (Hex)	Mode	Field Name	Description
0x33	7:4	0x8	R/W	heo_thresh[3:0]	HEO Threshold for CTLE Adaptation Handoff
	3:0	0x8	R/W	veo_thresh[3:0]	VEO Threshold for CTLE Adaptation Handoff
0x36	6	0x0	R/W	heo_veo_int_enable	Enable HEO/VEO Interrupt
	5:4	0x3	R/W	ref_mode[1:0]	Reference Clock Mode <1:0>
	2	0x0	R/W	mr_cdr_cap_dac_rng_ov	Enable Override for VCO Cap DAC Range
	1:0	0x1	R/W	mr_cdr_cap_dac_rng[1:0]	Cap DAC Range <1:0>
0x39	4:0	0x0	R/W	start_index[4:0]	Start Index for CTLE Adaptation <4:0> (Enable from Register 0x2f, Bit 3)
0x3a	7:6	0x2	R/W	fixed_eq_BST0[1:0]	Fixed CTLE Stage 0 Boost Setting for Lower Data Rates <1:0>
	5:4	0x2	R/W	fixed_eq_BST1[1:0]	Fixed CTLE Stage 1 Boost Setting for Lower Data Rates <1:0>
	3:2	0x1	R/W	fixed_eq_BST2[1:0]	Fixed CTLE Stage 2 Boost Setting for Lower Data Rates <1:0>
	1:0	0x1	R/W	fixed_eq_BST3[1:0]	Fixed CTLE Stage 3 Boost Setting for Lower Data Rates <1:0>
0x3e	7	0x1	R/W	HEO_VEO_LOCKMON_EN	Enable HEO/VEO Lock Monitoring
0x40 – 0x5f	CTLE Settings for Adaptation – see Table 6				
0x6a	7:4	0x4	R/W	veo_lick_thrsh[3:0]	Vertical Eye Opening Lock Threshold <3:0>
	3:0	0x4	R/W	heo_lick_thrsh[3:0]	Horizontal Eye Opening Lock Threshold <3:0>
0x6b	7:0	0x0	R/W	fom_a[7:0]	Adaptation Figure of Merit Term a<7:0>
0x6c	7:0	0x0	R/W	fom_b[7:0]	Adaptation Figure of Merit Term b<7:0>
0x6d	7:0	0x0	R/W	fom_c[7:0]	Adaptation Figure of Merit Term c<7:0>
0x6e	7	0x0	R/W	en_new_fom_ctle	Enable Alternate Figure of Merit for CTLE Adaptation
0x70	2:0	0x3	R/W	eq_lb_cnt[2:0]	CTLE Adaptation Look-Beyond Count <2:0>

Resetting Individual Channels of the Retimer

Register 0x00, bit 2, and register 0x0a, bits 3:2

Bit 2 of channel register 0x00 are used to reset all the registers for the corresponding channel to their factory default settings. This bit is self-clearing. Writing this bit will clear any register changes you have made in the DS100RT410 since it was powered-up.

To reset just the CDR state machine without resetting the register values, which will re-initiate the lock and adaptation sequence for a particular channel, use channel register 0x0a. Set bit 3 of this register to enable the reset override, then set bit 2 to force the CDR state machine into reset. These bits can be set in the same operation. When bit 2 is subsequently cleared, the CDR state machine will resume normal operation. If a signal is present at the input to the selected channel, the DS100RT410 will attempt to lock to it and will adapt its CTLE.

Interrupt Status

Control/Shared Register 0x05, bits 3:0, Register 0x01, bits 4 and 0, Register 0x30, bit 4, Register 0x32, and Register 0x36, bit 6

Each channel of the DS100RT410 will generate an interrupt under several different conditions. The DS100RT410 will always generate an interrupt when it loses CDR lock or when a signal is no longer detected at its input. If the HEO/VEO interrupt is enabled by setting bit 6 of register 0x36, then the retimer will generate an interrupt when the horizontal or vertical eye opening falls below the preset values even if the retimer remains locked. When one of these interrupt conditions occurs, the retimer alerts the system controller via hardware and provides additional details via register reads over the SMBus.

First, the open-drain interrupt line $\overline{\text{INT}}$ is pulled low. This indicates that one or more of the channels of the retimer has generated an interrupt. The interrupt lines from multiple reimers can be wire-ANDed together so that if any retimer generates an interrupt the system controller can be notified using a single interrupt input.

If the interrupt has occurred because the horizontal or vertical eye opening has dropped below the pre-set threshold, which is set in channel register 0x32, then bit 4 of register 0x30 will go high. This indicates that the source of the interrupt was the HEO or VEO.

If the interrupt has occurred because the CDR has fallen out of lock, or because the signal is no longer detected at the input, then bit 4 and/or bit 0 of register 0x01 will go high, indicating the cause of the interrupt.

In either case, the control/shared register set will indicate which channel caused the interrupt. This is read from bits 3:0 of control/shared register 0x05.

When an interrupt is detected by the controller on the interrupt input, the controller should take the following steps to determine the cause of the interrupt and clear it.

1. The controller detects the interrupt by detecting that the $\overline{\text{INT}}$ line has been pulled low by one of the reimers to which it is connected.
2. The controller reads control/shared register 0x05 from all the DS100RT410s connected to the $\overline{\text{INT}}$ line. For at least one of these devices, at least one of the bits 3:0 will be set in this register.
3. For each device with a bit set in bits 3:0 of control/shared register 0x05, the controller determines which channel or channels produced an interrupt. Refer to [Table 3](#) for a mapping of the bits in this bit field to the channel producing the interrupt.
4. When the controller detects that one of the reimers has a 1 in one of the four LSBs of this register, the controller selects the channel register set for that channel of that retimer by writing to the channel select register, 0xff, as previously described.
5. For each channel that generated an interrupt, the controller reads channel register 0x01. If bit 4 of this register is set, then the interrupt was caused by a loss of CDR lock. If bit 0 is set, then the interrupt was caused by a loss of signal. It is possible that both bits 0 and 4 could be set. Reading this register will clear these bits.
6. Optionally, for each channel that generated an interrupt, the controller reads channel register 0x30. If bit 4 of this register is set, then the interrupt was caused by HEO and/or VEO falling out of the configured range. This interrupt will only occur if bit 6 of channel register 0x36 is set, enabling the HEO/VEO interrupt. Reading register 0x30 will clear this interrupt bit.
7. Once the controller has determined what condition caused the interrupt, the controller can then take the appropriate action. For example, the controller might reset the CDR to cause the retimer to re-adapt to the

incoming signal. If there is no longer an incoming signal (indicated by a loss of signal interrupt, bit 0 of channel register 0x01), then the controller might alert an operator or change the channel configuration. This is system dependent.

8. Reading the interrupt status registers will clear the interrupt. If this does not cause the interrupt input to go high, then another device on the same input has generated an interrupt. The controller can address the next device using the procedure above.
9. Once all the interrupt registers for all channels for all DS100RT410s that generated interrupts have been read, clearing all the interrupt indications, the $\overline{\text{INT}}$ line should go high again. This indicates that all the existing interrupt conditions have been serviced.

The channel registers referred to above, registers 0x01, 0x30, 0x32, and 0x36, are described in the channel registers table, [Table 5](#).

Overriding the CTLE Boost Setting

Register 0x03, Register 0x13, bit 2, and Register 0x3a

To override the CTLE boost settings, register 0x03 is used. This register contains the currently-applied CTLE boost settings. The boost values can be overridden by using the two-bit fields in this register as shown in the table.

The final stage of the CTLE has an additional control bit which sets it to a limiting mode. For some channels, this additional setting improves the bit error rate performance. This bit is bit 2 of register 0x13.

If the DS100RT410 loses lock because of a change in the CTLE settings, the DS100RT410 will initiate its lock and adaptation sequence again. Thus, if you write new CTLE boost values to register 0x03 and 0x13 which cause the DS100RT410 to drop out of lock, the DS100RT410 may, in the process of reacquiring the CDR lock, reset the CTLE settings to different values than those you set in register 0x03 and 0x13. If this behavior is not understood, it can appear that the DS100RT410 did not accept the values you wrote to the CTLE boost registers. What's really happening, however, is that the lock and adaptation sequence is overriding the CTLE values you wrote to the CTLE boost registers. This will not happen unless the DS100RT410 drops out of lock.

If the adapt mode is set to 0 (bits 6:5 of channel register 0x31), then the CTLE boost values will not be overridden, but the DS100RT410 may still lose lock. If this happens, the DS100RT410 will attempt to reacquire lock. If the reference mode is set correctly, and if the rate/subrate code is set to permit it, the DS100RT410 will begin searching for CDR lock at the highest allowable VCO divider ratio – that is, at the lowest configured bit rate. At this lowest bit rate, the CTLE boost settings used will come not from the values in register 0x03, and 0x13, but rather from register 0x3a, the fixed CTLE boost setting for lower data rates. This setting will be written into boost setting register 0x03 during the lock search process. This value may be different from the value you set in register 0x03, so, again, it may appear that the DS100RT410 has not accepted the CTLE boost settings you set in registers 0x03 and 0x13. The interactions of the lock and adaptation sequences with the manually-set CTLE boost settings can be difficult to understand.

To manually override the CTLE boost under all conditions, perform the following steps.

1. Set the DS100RT410 channel adapt mode to 0 by writing 0x0 to bits 6:5 of channel register 0x31.
2. Set the desired CTLE boost setting in register 0x3a. If the DS100RT410 loses lock and attempts to lock to a lower data rate, it will use this CTLE boost setting.
3. Set the desired CTLE boost setting in register 0x03. This may cause the DS100RT410 to lose lock.
4. If desired, set the CTLE stage 3 limiting bit, bit 2 of register 0x13.

If the DS100RT410 loses lock when the CTLE boost settings are set according to the sequence above, the DS100RT410 will try to reacquire lock, but it will not change the CTLE boost settings in order to do so.

Overriding the CTLE Settings Used for CTLE Adaptation

Register 0x2c, bits 3:0, Register 0x2f, bit 3, Register 0x39, bits 4:0, and Registers 0x50-0x5f

The CTLE adaptation algorithm operates by setting the CTLE boost stage controls to a set of pre-determined boost settings, each of which provides progressively more high-frequency boost. At each stage in the adaptation process, the DS100RT410 attempts to phase lock to the equalized signal. If the phase lock succeeds, the DS100RT410 measures the horizontal and vertical eye openings using the internal eye monitor circuit. The DS100RT410 computes a figure of merit for the eye opening and compares it to the previous best value of the

figure of merit. While the figure of merit continues to improve, the DS100RT410 continues to try additional values of the CTLE boost setting until the figure of merit ceases to improve and begins to degrade. When the figure of merit starts to degrade, the DS100RT410 still continues to try additional CTLE settings for a pre-determined trial count called the “look-beyond” count, and if no improvement in the figure of merit results, it resets the CTLE boost values to those that produced the best figure of merit. The resulting CTLE boost values are then stored in register 0x03. The “look-beyond” count is configured by the value in register 0x2c, bits 3:0. The value is 0x2 by default.

The set of boost values used as candidate values during CTLE adaptation are stored as bit fields in registers 0x40-0x5f. The default values for these settings are shown in [Table 6](#). These values may be overridden by setting the corresponding register values over the SMBus. If these values are overridden, then the next time the CTLE adaptation is performed the set of CTLE boost values stored in these registers will be used for the adaptation. Resetting the channel registers by setting bit 2 of channel register 0x00 will reset the CTLE boost settings to their defaults. So will power-cycling the DS100RT410.

Table 6. CTLE Settings for Adaptation

Register (Hex)	Bits 7:6 (CTLE Stage 0)	Bits 5:4 (CTLE Stage 1)	Bits 3:2 (CTLE Stage 2)	Bits 1:0 (CTLE Stage 2)	CTLE Boost String	CTLE Adaptation Index
40	0	0	0	0	0000	0
41	0	0	0	1	0001	1
42	0	0	1	0	0010	2
43	0	1	0	0	0100	3
44	1	0	0	0	1000	4
45	0	0	2	0	0020	5
46	0	0	0	2	0002	6
47	2	0	0	0	2000	7
48	0	0	0	3	0003	8
49	0	0	3	0	0030	9
4A	0	3	0	0	0300	10
4B	1	0	0	1	1001	11
4C	1	1	0	0	1100	12
4D	3	0	0	0	3000	13
4E	1	2	0	0	1200	14
4F	2	1	0	0	2100	15
50	2	0	2	0	2020	16
51	2	0	0	2	2002	17
52	2	2	0	0	2200	18
53	1	0	1	2	1012	19
54	1	1	0	2	1102	20
55	2	0	3	0	2030	21
56	2	3	0	0	2300	22
57	3	0	2	0	3020	23
58	1	1	1	3	1113	24
59	1	1	3	1	1131	25
5A	1	2	2	1	1221	26
5B	1	3	1	1	1311	27
5C	3	1	1	1	3111	28
5D	2	1	2	1	2121	29
5E	2	1	1	2	2112	30
5F	2	2	1	1	2211	31

As an alternative to, or in conjunction with, writing the CTLE boost setting registers 0x40 through 0x5f, it is possible to set the starting CTLE boost setting index. To override the default setting, which is 0, set bit 3 of register 0x2f. When this bit is set, the starting index for adaptation comes from register 0x39, bits 4:0. This is the index into the CTLE settings table in registers 0x40 through 0x5f. When this starting index is 0, which is the default, CTLE adaptation starts at the first setting in the table, the one in register 0x40, and continues until the optimum FOM is reached.

Overriding the Output Multiplexer

Register 0x09, bit 5, Register 0x14, bits 7:6, and Register 0x1e, bits 7:5

By default, the DS100RT410 output for each channel will be as shown in [Table 7](#).

Table 7. Default Output Status Description

Input Signal Status	Channel Status	Output Status
Not Present	No Signal Detected	Muted
Present	Not Locked	Muted
Present	Locked	Retimed Data

This default behavior can be modified by register writes.

Register 0x1e, bits 7:5, contain the output multiplexer override value. The values of this three-bit field and the corresponding meanings of each are shown in

Table 8. Output Multiplexer Override Settings

Bit Field Value	Output Multiplexer Setting	Comments
0x7	Mute	Default when no signal is present or when the retimer is unlocked
0x6	N/A	Invalid Setting
0x5	10 MHz Clock	Internal 10 MHz clock Clock frequency may not be precise
0x4	PRBS Generator	PRBS Generator must be enabled to output PRBS sequence
0x3	VCO Q-Clock	Register 0x09, bit 4, and register 0x1e, bit 0, must be set to enable the VCO Q-Clock
0x2	VCO I-Clock	
0x1	Retimed Data	Default when the retimer is locked
0x0	Raw Data	

If the output multiplexer is not overridden, that is, if bit 5 of register 0x09 is not set, then the value in register 0x1e, bits 7:5, controls the output produced when the retimer has a signal at its input, but is not locked to it. The default value for this bit field, 0x7, causes the retimer output to mute when the retimer is not locked to an input signal. Writing a value of 0x0 to this bit field, for example, will cause the retimer to output raw data when it is not locked to its input signal.

Setting the override bit, bit 5 of register 0x09, will cause the retimer to output the value selected by the bit field in register 0x1e, bits 7:5, even when the retimer is locked.

When no signal is present at the input to the selected channel of the DS100RT410 the signal detect circuitry will power down the channel. This includes the output driver which is therefore muted when no signal is present at the input. If you want to get an output when no signal is present at the input, for example to enable a free-running PRBS sequence, the first step is to override the signal detect. In order to force the signal detect on, set bit 7 and clear bit 6 of channel register 0x14. Even if there is no signal at the input to the channel, the channel will be enabled. If the channel was disabled before, the current drain from the supply will increase by 100–150 mA depending upon the other channel settings in the device. This increased current drain indicates that the channel is now enabled.

The second step is to override the output multiplexer setting. This is accomplished by setting bit 5 of register 0x09, the output multiplexer override. Once this bit is set, the value of register 0x1e, bits 7:5 will control the output of the channel. Note that if either retimed or raw data is selected, the output will just be noise. The device output may saturate to a static 1 or 0.

If there is no signal, the VCO clock will be free-running. Its frequency will depend upon the divider settings and it will vary from part to part and over temperature.

If the PRBS generator is enabled, the PRBS generator output can be selected. This can either be at a data rate determined by the free-running VCO or at a data rate determined by the input signal, if one is present. If a signal is present at the input and the DS100RT410 can lock to it, the output of the PRBS generator will be synchronous with the input signal, but the bit stream output will be determined by the PRBS generator selection.

The 10 MHz clock is always available at the output when the output multiplexer is overridden. The 10 MHz clock is a free-running oscillator in the DS100RT410 and is not synchronous to the input or to anything else in the system. The clock frequency will be approximately 10 MHz, but this will vary from part to part.

If there is a signal present at the input, it is not necessary to override the signal detect. Clearing bits 7 and 6 of register 0x14 will return control of the signal detect to the DS100RT410. Normally, when the retimer is locked to a signal at its input, it will output retimed data. However, if desired, the output multiplexer can be overridden in this condition to output raw data. It can also be set to output any of the other signals shown in [Table 8](#). If there is an input signal, and if the DS100RT410 is locked to it, the VCO I-Clock, the VCO Q-Clock, and the output of the PRBS generator, if it is enabled, will be synchronous to the input signal.

When a signal is present at the input, it might be desired to output the raw data in order to see the effects of the CTLE without the CDR. It might also be desired to enable the PRBS generator and output this signal, replacing the data content of the input signal with the internally-generated PRBS sequence.

Overriding the VCO Divider Selection

Register 0x09, bit 2, and Register 0x18, bits 6:4

In normal operation, the DS100RT410 sets its VCO divider to the correct divide ratio, either 1, 2, 4, 8, or 16, depending upon the bit rate of the signal at the channel input. It is possible to override the divider selection. This might be desired if the VCO is set to free-run, for example, to output a signal at a sub-harmonic of the actual VCO frequency.

In order to override the VCO divider settings, first set bit 2 of register 0x09. This is the VCO divider override enable. Once this bit is set, the VCO divider setting is controlled by the value in register 0x18, bits 6:4. The valid values for this three-bit field are 0x0 to 0x4. The mapping of the bit field values to the divider ratio is shown in [Table 9](#).

Table 9. Divider Ratio Mapping to Register 0x18, Bits 6:4

Bit Field Value	Divider Ratio
0	1
1	2
2	4
3	8
4	16

in normal operation, the DS100RT410 will determine the required VCO divider ratio automatically. The most common application for overriding the divider ratio is when the VCO is set to free-run. Normally the divider ratio should not be overridden except in this case.

Using the PRBS Generator

Register 0x0d, bit 5, Register 0x1e, bit 4, and Register 0x30, bit 3 and bits 1:0

The DS100RT410 includes an internal PRBS generator which can generate standard PRBS-9 and PRBS-31 bit sequences. The PRBS generator can produce a PRBS sequence that is synchronous to the incoming data signal, or it can generate a PRBS sequence using the internal free-running VCO as a clock. Both modes of operation are described in the paragraphs that follow.

To produce a PRBS sequence that is synchronized to the incoming data signal, the DS100RT410 must be locked to the incoming signal. When this is true, the signal detect is set and the channel is active. In addition, the VCO is locked to the incoming signal. The VCO will remain locked to the incoming signal regardless of the state of the output multiplexer.

To activate the PRBS generator, first set bit 4 of register 0x1e. This bit enables the PRBS generator digital circuitry. Then reset the PRBS clock by clearing bit 3 of register 0x30. Select either PRBS-9 or PRBS-31 by setting bits 1:0 of register 0x30. Set this bit field to 0x0 for PRBS-9 and to 0x2 for PRBS-31. Then load the PRBS clock by setting bit 3 of register 0x30. Finally, enable the PRBS clock by setting bit 5 of register 0x0d. This sequence of register writes will enable the internal PRBS generator.

As described above, to select the PRBS generator as the output for the selected channel, set bit 5 of register 0x09, the output multiplexer override. Then write 0x4 to bits 7:5 of register 0x1e. This selects the PRBS generator for output.

For the case described above, the output PRBS sequence will be synchronous to the incoming data. There are two other cases of interest. The first is when there is an input signal but the PRBS sequence should not be synchronous to it. In other words, in this case it is desired that the VCO should free-run. The second case is when there is no input signal, but the PRBS sequence should still be output. Again, in this case, the VCO is free-running.

The register settings for these two cases are almost the same. The only difference is that, if there is no input signal, then the channel will be disabled and powered-down by default. In order to force enable the channel, write a 1 to bit 7 and a 0 to bit 6 of register 0x14. This forces the signal detect to be active and enables the selected channel.

The remainder of the register write sequence is designed to disable the phase-locked loop so that the VCO can free run.

First write a 1 to bit 3 of register 0x09, then 0x0 to bits 1:0 of register 0x1b. This disables the charge pump for the phase-locked loop.

Next write a 1 to bit 2 of register 0x09. This enables the VCO divider override. Then set the VCO divider ratio by writing to register 0x18 as shown in [Table 9](#). For an output frequency of approximately 10.3125 GHz, set the divider ratio to 1 by writing 0x0 to bits 6:4 of register 0x18. Do not clear bit 3 when you write a 1 to bit 2 of register 0x09.

Now write a 1 to bit 7 of register 0x09. This enables the VCO CAP DAC override. Write the desired VCO cap count to register 0x08, bits 4:0. The mapping of VCO frequencies to cap count will vary somewhat from part to part. The VCO cap count should be set to 0x0c to yield an output VCO frequency of approximately 10.3125 GHz. Do not clear bits 3 and 2 when you write a 1 to bit 7 of register 0x09.

Now write a 1 to bit 6 of register 0x09. This enables the VCO LPF DAC which can generate a VCO control voltage internally to the DS100RT410. Once the LPF DAC is enabled, write the desired value of the LPF DAC output in register 0x1f, bits 4:0. For an output VCO frequency of approximately 10.3125 GHz, set the LPF DAC setting to 0x12. Do not clear the remaining bits of register 0x09 when you write a 1 to bit 6.

Now, as above, enable the PRBS generator and set it to the desired bit sequence, then select the output to be the PRBS generator by setting the output multiplexer. Notice that when this entire sequence has been completed, bits 7:2 of register 0x09 will all be set. The default value of register 0x09 is 0x00, so you can clear all the overrides when you are ready to return to normal operation by writing 0x00 to register 0x09.

The VCO frequency in free-run will vary somewhat from part to part. In order to determine exact values of the CAP DAC and LPF DAC settings, it will be necessary to directly measure the VCO frequency using some sort of frequency-measurement device such as a frequency counter or a spectrum analyzer. When the VCO is set to free-run mode as above, you can select the VCO I-clock (in-phase clock) to be the output as shown in [Table 8](#). You can measure the frequency of the VCO I-clock while adjusting the CAP DAC and LPF DAC values until the VCO I-clock frequency is acceptable for your application. Then you can once again select the PRBS generator as the output using the output multiplexer selection field.

Using the Internal Eye Opening Monitor

Register 0x11, bits 7:6 and bit 5, Register 0x22, bit 7, Register 0x24, bit 7 and bit 0, Register 0x25, Register 0x26, Register 0x27, Register 0x28, and Register 0x2a

The DS100RT410 includes an internal eye opening monitor. The eye opening monitor is used by the retimer to compute a figure of merit for automatic adaptation of the CTLE. It can also be controlled and queried through the SMBus by a system controller.

The eye opening monitor produces error hit counts for settable phase and voltage offsets of the comparator in the retimer. This is similar to the way many Bit Error Rate Test Sets measure eye opening. At each phase and amplitude offset setting, the eye opening monitor determines the nominal bit value (“0” or “1”) using its primary comparator. This is the bit value that is resynchronized to the recovered clock and presented at the output of the DS100RT410. The eye opening monitor also determines the bit value detected by the offset comparator. This information yields an eye contour. Here's how this works.

If the offset comparator is offset in voltage by an amount larger than the vertical eye opening, for example, then the offset comparator will always decide that the current bit has a bit value of “0”. When the bit is really a “1”, as determined by the primary comparator, this is considered a bit error. The number of bit errors is counted for a settable interval at each setting of the offset phase and voltage of the offset comparator. These error counts can be read from registers 0x25 and 0x26 for sequential phase and voltage offsets. These error counts for each phase and voltage offsets form a 64 X 64 point array. A surface or contour plot of the error hit count versus phase and voltage offset produces an eye diagram, which can be plotted by external software.

The eye opening monitor works in two modes. In the first, only the horizontal and vertical eye openings are measured. The eye opening monitor first sweeps its variable-phase clock through one unit interval with the comparison voltage set to the mid point of the signal. This determines the midpoint of the horizontal eye opening. The eye opening monitor then sets its variable phase clock to the midpoint of the horizontal eye opening and sweeps its comparison voltage. These two measurements determine the horizontal and vertical eye openings. The horizontal eye opening value is read from register 0x27 and the vertical eye opening from register 0x28. Both values are single byte values.

The measurement of horizontal and vertical eye opening is very fast. The speed of this measurement makes it useful for determining the adaptation figure of merit. In normal operation, the HEO and VEO are automatically measured periodically to determine whether the DS100RT410 is still in lock. Reading registers 0x27 and 0x28 will yield the most-recently measured HEO and VEO values.

In normal operation, the eye monitor circuitry is powered down most of the time to save power. When the eye is to be measured under external control, it must first be enabled by writing a 0 to bit 5 of register 0x11. The default value of this bit is 1, which powers down the eye monitor except when it is powered-up periodically by the CDR state machine and used to test CDR lock. The eye monitor must be powered up to measure the eye under external SMBus control.

Bits 7:6 of register 0x11 are also used during eye monitor operation to set the EOM voltage range. This is described below. A single write to register 0x11 can set both bit 5 and bits 7:6 in one operation.

Register 0x3e, bit 7, enables horizontal and vertical eye opening measurements as part of the lock validation sequence. When this bit is set, the CDR state machine periodically uses the eye monitor circuitry to measure the horizontal and vertical eye opening. If the eye openings are too small, according to the pre-determined thresholds in register 0x6a, then the CDR state machine declares lock loss and begins the lock acquisition process again. For SMBus acquisition of the internal eye, this lock monitoring function must be disabled. Prior to overriding the EOM by writing a 1 to bit 0 of register 0x24, disable the lock monitoring function by writing a 0 to bit 7 of register 0x3e. Once the eye has been acquired, you can reinstate HEO and VEO lock monitoring by once again writing a 1 to bit 7 of register 0x3e.

Under external SMBus control, the eye opening monitor can be programmed to sweep through all its 64 states of phase and voltage offset autonomously. This mode is initiated by setting register 0x24, bit 7, the fast_eom mode bit. Register 0x22, bit 7, the eom_ov bit, should be cleared in this mode.

When the fast_eom bit is set, the eye opening monitor operation is initiated by setting bit 0 of register 0x24, which is self-clearing. As soon as this bit is set, the eye opening monitor begins to acquire eye data. The results of the eye opening monitor error counter are stored in register 0x25 and 0x26. In this mode the eye opening monitor results can be obtained by repeated multi-byte reads from register 0x25. It is not necessary to read from register 0x26 for a multi-byte read. As soon as the eight most significant bits are read from register 0x25, the eight least significant bits for the current setting are loaded into register 0x25 and they can be read immediately.

As soon as the read of the eight most significant bits has been initiated, the DS100RT410 sets its phase and voltage offsets to the next setting and starts its error counter again. The result of this is that the data from the eye opening monitor is available as quickly as it can be read over the SMBus with no further register writes required. The external controller just reads the data from the DS100RT410 over the SMBus as fast as it can. When all the data has been read, the DS100RT410 clears the `eom_start` bit.

If multi-byte reads are not used, meaning that the device is addressed each time a byte is read from it, then it is necessary to read register 0x25 to get the MSB (the eight most significant bits) and register 0x26 to get the LSB (the eight least significant bits) of the current eye monitor measurement. Again, as soon as the read of the MSB has been initiated, the DS100RT410 sets its phase and voltage offsets to the next setting and starts its error counter again. In this mode both registers 0x25 and 0x26 must be read in order to get the eye monitor data. The eye monitor data for the next set of phase and voltage offsets will not be loaded into registers 0x25 and 0x26 until both registers have been read for the current set of phase and voltage offsets.

In all eye opening monitor modes, the amount of time during which the eye opening monitor accumulates eye opening data can be set by the value of register 0x2a. In general, the greater this value the longer the accumulation time. When this value is set to its maximum possible value of 0xff, the maximum number of samples acquired at each phase and amplitude offset is approximately 2^{18} . Even with this setting, the eye opening monitor values can be read from the SMBus with no delay. The eye opening monitor operation is sufficiently fast that the SMBus read operation cannot outrun it.

The eye opening is measured at the input to the data comparator. At this point in the data path, a significant amount of gain has been applied to the signal by the CTLE. In many cases, the vertical eye opening as measured by the EOM will be on the order of 400 to 500 mV peak-to-peak. The secondary comparator, which is used to measure the eye opening, has an adjustable voltage range from ± 100 mV to ± 400 mV. The EOM voltage range is normally set by the CDR state machine during lock and adaptation, but the range can be overridden by writing a two-bit code to bits 7:6 of register 0x11. The values of this code and the corresponding EOM voltage ranges are shown in [Table 10](#).

Table 10. EOM Voltage Range vs. Bits 7:6 of Register 0x11

Value in Bits 7:6 of Register 0x11	EOM Voltage Range (\pm mV)
0x0	± 100
0x1	± 200
0x2	± 300
0x3	± 400

Note that the voltage ranges shown in [Table 10](#) are the voltage ranges of the signal at the input to the data path comparator. These values are not directly equivalent to any observable voltage measurements at the input to the DS100RT410. Note also that if the EOM voltage range is set too small the voltage sweep of the secondary comparator may not be sufficient to capture the vertical eye opening. When this happens the eye boundaries will be outside the vertical voltage range of the eye measurement.

Enabling Slow Rise/Fall Time on the Output Driver

Register 0x18, bit 2

Normally the rise and fall times of the output driver of the DS100RT410 are set by the slew rate of the output transistors. By default, the output transistors are biased to provide the maximum possible slew rate, and hence the minimum possible rise and fall times. In some applications, slower rise and fall times may be desired. For example, slower rise and fall times may reduce the amplitude of electromagnetic interference (EMI) produced by a system.

Setting bit 2 of register 0x18 will adjust the output driver circuitry to increase the rise and fall times of the signal. Setting this bit will approximately double the nominal rise and fall times of the DS100RT410 output driver. This bit is cleared by default.

Inverting the Output Polarity

Register 0x1f, bit 7

In some systems, the polarity of the data does not matter. In systems where it does matter, it is sometimes necessary, for the purposes of trace routing, for example, to invert the normal polarities of the data signals.

The DS100RT410 can invert the polarity of the data signals by means of a register write. Writing a 1 to bit 7 of register 0x1f inverts the polarity of the output signal for the selected channel. This can provide additional flexibility in system design and board layout.

Overriding the Figure of Merit for Adaptation

Register 0x2c, bits 5:4, Register 0x31, bits 6:5, Register 0x6b, Register 0x6c, Register 0x6d, and Register 0x6e, bits 7 and 6

The default figure of merit for the CTLE adaptation is simple. The horizontal and vertical eye openings are measured for each CTLE boost setting. The vertical eye opening is scaled to a constant reference vertical eye opening and the smaller of the horizontal or vertical eye opening is taken as the figure of merit for that set of equalizer settings. The objective is to adapt the equalizer to a point where the horizontal and vertical eye openings are both as large as possible. This usually provides optimum bit error rate performance for most transmission channels.

In some systems the adaptation can reach a better setting if only the horizontal or only vertical eye opening is used to compute the figure of merit rather than using both. This will be system-dependent and the user must determine through experiment whether this provides better adaptation in the user's system. For the DS100RT410, the CTLE figure of merit type can be set using register 0x31, bits 4:3. The value of this two-bit field versus the configured figure of merit type is shown in [Table 11](#).

Table 11. Figure of Merit Type Setting

Register 0x31, bits 4:3	Figure of Merit Type
0x0	Both HEO and VEO are used
0x1	Only HEO is used
0x2	Only VEO is used
0x3	Both HEO and VEO are used (default)

For some transmission media the adaptation can reach a better setting if a different figure of merit is used. The DS100RT410 includes the capability of adapting based on a configurable figure of merit. The configurable figure of merit is structured as shown in the equation below.

$$\text{FOM} = (\text{HEO} - b) \times a + (\text{VEO} - c) \times (1 - a)$$

In this equation, HEO is horizontal eye opening, VEO is vertical eye opening, FOM is the figure of merit, and the factors a, b, and c are set using registers 0x6b, 0x6c, and 0x6d respectively.

In order to use the configurable figure of merit, the enable bits must be set. To use the configurable figure of merit for the CTLE adaptation, set bit 7 of register 0x6e, the en_new_fom_ctle bit.

Setting the Rate and Subrate for Lock Acquisition

Register 0x2f, bits 7:6 and 5:4

The rate and subrate settings, which configure the set of VCO frequencies to which the VCO coarse tuning is to be calibrated are set using channel register 0x2f. Bits 7:6 are RATE<1:0>, and bits 5:4 are SUBRATE<1:0>.

Setting the Adaptation/Lock Mode

Register 0x31, bits 6:5, Register 0x3e, bit 7, and Register 0x6a

There are 2 adaptation modes available in the DS100RT410.

- Mode 0: The user is responsible for setting the CTLE values. This mode is used if the transmission channel response is fixed.
- Mode 1: The CTLE is adapted to equalize the transmission channel. This mode is primarily used for smoothly-varying high-loss transmission channels such as cables and simple PCB traces.

Bits 6:5 of register 0x31 determine the adaptation mode to be used. The mapping of these register bits to the adaptation algorithm is shown in [Table 5](#).

Table 12. DS100RT410 Adaptation Algorithm Settings

Register 0x31, Bit 6 adapt_mode[1]	Register 0x31, Bit 5 adapt_mode[0]	Adapt Mode Setting <1:0>	Adaptation Algorithm
0	0	00	No Adaptation
0	1	01	Adapt CTLE Until Optimum (Default)

By default the DS100RT410 requires that the equalized internal eye exhibit horizontal and vertical eye openings greater than a pre-set minimum in order to declare a successful lock. The minimum values are set in register 0x6a.

The DS100RT410 continuously monitors the horizontal and vertical eye openings while it is in lock. If the eye opening falls below the threshold set in register 0x6a, the DS100RT410 will declare a loss of lock.

Initiating Adaptation

Register 0x24, bit 2, and Register 0x2f, bit 0

When the DS100RT410 becomes unlocked, it will automatically try to acquire lock and adapt its CTLE.

Adaptation can also be initiated by the user. CTLE adaptation can be initiated by setting and then clearing register 0x2f, bit 0.

Setting the Reference Enable Mode

Register 0x36, bits 5:4

Register 0x36, bits 5:4, are the ref_mode<1:0> bits. These bits should be set to a value of 2'b11. Note that this is not the default. The reference mode must be set prior to using the DS100RT410.

A 25 MHz reference clock signal must be provided on the reference in pin (pin 19). The use of the reference clock in the DS100RT410 is explained below.

First, the reference clock allows the DS100RT410 to calibrate its VCO frequency at power-up and upon reset. This enables the DS100RT410 to determine the optimum coarse VCO tuning setting *a-priori*, which makes phase lock much faster. The DS100RT410 is not required to tune through the available coarse VCO tuning settings as it tries to acquire lock to an input signal. It can select the correct setting immediately.

Second, if the DS100RT410 loses lock for some reason and the VCO drifts from its phase-locked frequency, the DS100RT410 can detect this very quickly using the reference clock. Detecting an out-of-lock condition quickly allows the DS100RT410 to raise an interrupt indicating that it has lost lock quickly, which the system controller can then service to correct the problem quickly.

Finally, some data signals with large jitter spurs in their frequency spectra can cause the DS100RT410 to false lock. This occurs when the data pattern exhibits strong discrete frequency components in its frequency spectrum, or when the data pattern has a lot of periodic jitter imposed on it. If you look at such a signal in the frequency domain using a spectrum analyzer, it will clearly show “spurs” close in to the fundamental data rate frequency. These spurs can cause the DS100RT410 to false lock.

Using the 25 MHz reference clock, the DS100RT410 can detect when it is locked to a jitter spur. When this happens, the DS100RT410 will re-initiate the adaptation and lock sequence until it locks to the correct data rate. This provides immunity to false lock conditions.

The reference clock mode is set by a two-bit field, register 0x36, bits 5:4. This field should always be set to a value of 3 or 2'b11.

Setting the Output Differential Voltage

Register 0x2d, bits 2:0

There are eight levels of output differential voltage available in the DS100RT410, from 0.6 V to 1.3 V in 0.1 V increments. The values `drv_sel_vod[2:0]` in bits 2:0 of register 0x2d set the output VOD. The available VOD settings and the corresponding values of this bit field are shown in [Table 13](#).

Table 13. VOD Settings

Bit 2, <code>drv_sel_vod[2]</code>	Bit 1, <code>drv_sel_vod[1]</code>	Bit 0, <code>drv_sel_vod[0]</code>	Selected VOD (V, peak-to-peak, differential)
0	0	0	0.6
0	0	1	0.7
0	1	0	0.8
0	1	1	0.9
1	0	0	1.0
1	0	1	1.1
1	1	0	1.2
1	1	1	1.3

Setting the Output De-emphasis Setting

Register 0x15, bits 2:0 and bit 6

Fifteen output de-emphasis settings are available in the DS100RT410, ranging from 0 dB to -12 dB. The de-emphasis values come from register 0x15, bits 2:0, which make up the bit field `dvr_dem<2:0>`, and register 0x15, bit 6, which is the de-emphasis range bit.

The available driver de-emphasis settings and the mapping to these bits are shown in [Table 14](#).

Table 14. Driver De-Emphasis Settings

Register 0x15, Bit 2, <code>dvr_dem[2]</code>	Register 0x15, Bit 1, <code>dvr_dem[1]</code>	Register 15, Bit 0, <code>dvr_dem[0]</code>	Register 0x15, Bit 6, <code>dvr_dem_range</code>	De-emphasis Setting (dB)
0	0	0	X	0.0
0	0	1	1	-0.9
0	0	1	0	-1.5
0	1	0	1	-2.0
0	1	1	1	-2.8
1	0	0	1	-3.3
0	1	0	0	-3.5
1	0	1	1	-3.9
1	1	0	1	-4.5
0	1	1	0	-5.0
1	1	1	1	-5.6
1	0	0	0	-6.0
1	0	1	0	-7.5
1	1	0	0	-9.0
1	1	1	0	-12.0

PACKAGING INFORMATION

Orderable Device	Status (1)	Package Type	Package Drawing	Pins	Package Qty	Eco Plan (2)	Lead/Ball Finish	MSL Peak Temp (3)	Op Temp (°C)	Top-Side Markings (4)	Samples
DS100RT410SQ/NOPB	ACTIVE	WQFN	RHS	48	1000	Green (RoHS & no Sb/Br)	CU SN	Level-3-260C-168 HR	-40 to 85	100RT410	Samples
DS100RT410SQE/NOPB	ACTIVE	WQFN	RHS	48	250	Green (RoHS & no Sb/Br)	CU SN	Level-3-260C-168 HR	-40 to 85	100RT410	Samples

(1) The marketing status values are defined as follows:

ACTIVE: Product device recommended for new designs.

LIFEBUY: TI has announced that the device will be discontinued, and a lifetime-buy period is in effect.

NRND: Not recommended for new designs. Device is in production to support existing customers, but TI does not recommend using this part in a new design.

PREVIEW: Device has been announced but is not in production. Samples may or may not be available.

OBSOLETE: TI has discontinued the production of the device.

(2) Eco Plan - The planned eco-friendly classification: Pb-Free (RoHS), Pb-Free (RoHS Exempt), or Green (RoHS & no Sb/Br) - please check <http://www.ti.com/productcontent> for the latest availability information and additional product content details.

TBD: The Pb-Free/Green conversion plan has not been defined.

Pb-Free (RoHS): TI's terms "Lead-Free" or "Pb-Free" mean semiconductor products that are compatible with the current RoHS requirements for all 6 substances, including the requirement that lead not exceed 0.1% by weight in homogeneous materials. Where designed to be soldered at high temperatures, TI Pb-Free products are suitable for use in specified lead-free processes.

Pb-Free (RoHS Exempt): This component has a RoHS exemption for either 1) lead-based flip-chip solder bumps used between the die and package, or 2) lead-based die adhesive used between the die and leadframe. The component is otherwise considered Pb-Free (RoHS compatible) as defined above.

Green (RoHS & no Sb/Br): TI defines "Green" to mean Pb-Free (RoHS compatible), and free of Bromine (Br) and Antimony (Sb) based flame retardants (Br or Sb do not exceed 0.1% by weight in homogeneous material)

(3) MSL, Peak Temp. -- The Moisture Sensitivity Level rating according to the JEDEC industry standard classifications, and peak solder temperature.

(4) Multiple Top-Side Markings will be inside parentheses. Only one Top-Side Marking contained in parentheses and separated by a "~" will appear on a device. If a line is indented then it is a continuation of the previous line and the two combined represent the entire Top-Side Marking for that device.

Important Information and Disclaimer: The information provided on this page represents TI's knowledge and belief as of the date that it is provided. TI bases its knowledge and belief on information provided by third parties, and makes no representation or warranty as to the accuracy of such information. Efforts are underway to better integrate information from third parties. TI has taken and continues to take reasonable steps to provide representative and accurate information but may not have conducted destructive testing or chemical analysis on incoming materials and chemicals. TI and TI suppliers consider certain information to be proprietary, and thus CAS numbers and other limited information may not be available for release.

In no event shall TI's liability arising out of such information exceed the total purchase price of the TI part(s) at issue in this document sold by TI to Customer on an annual basis.

TAPE AND REEL INFORMATION

QUADRANT ASSIGNMENTS FOR PIN 1 ORIENTATION IN TAPE

*All dimensions are nominal

Device	Package Type	Package Drawing	Pins	SPQ	Reel Diameter (mm)	Reel Width W1 (mm)	A0 (mm)	B0 (mm)	K0 (mm)	P1 (mm)	W (mm)	Pin1 Quadrant
DS100RT410SQ/NOPB	WQFN	RHS	48	1000	330.0	16.4	7.3	7.3	1.3	12.0	16.0	Q1
DS100RT410SQE/NOPB	WQFN	RHS	48	250	178.0	16.4	7.3	7.3	1.3	12.0	16.0	Q1

TAPE AND REEL BOX DIMENSIONS

*All dimensions are nominal

Device	Package Type	Package Drawing	Pins	SPQ	Length (mm)	Width (mm)	Height (mm)
DS100RT410SQ/NOPB	WQFN	RHS	48	1000	367.0	367.0	38.0
DS100RT410SQE/NOPB	WQFN	RHS	48	250	213.0	191.0	55.0

RHS0048A

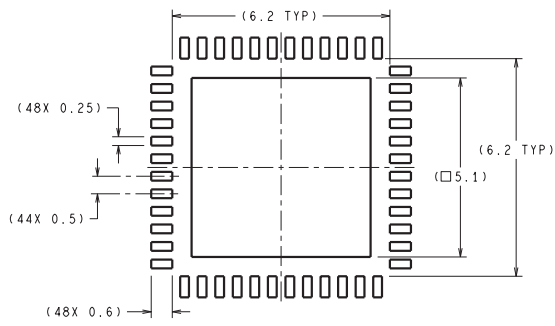

DIMENSIONS ARE IN MILLIMETERS
DIMENSIONS IN () FOR REFERENCE ONLY

RECOMMENDED LAND PATTERN

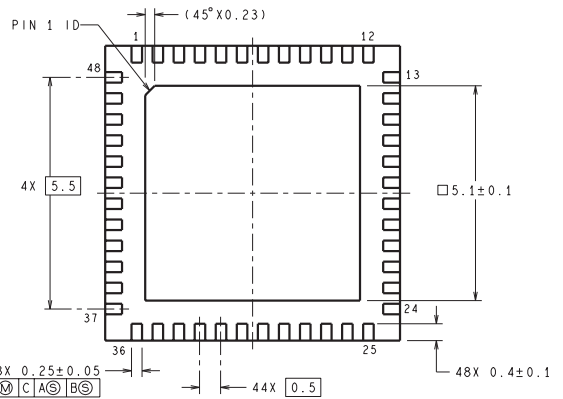
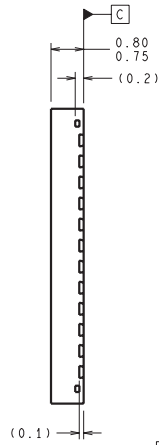
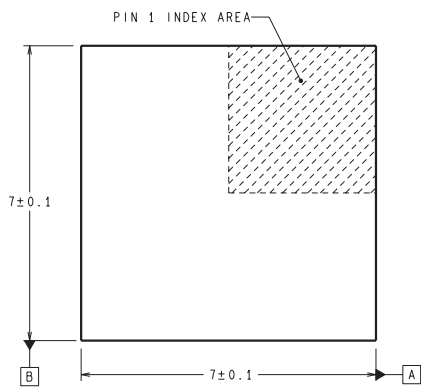

SQA48A (Rev B)

IMPORTANT NOTICE

Texas Instruments Incorporated and its subsidiaries (TI) reserve the right to make corrections, enhancements, improvements and other changes to its semiconductor products and services per JESD46, latest issue, and to discontinue any product or service per JESD48, latest issue. Buyers should obtain the latest relevant information before placing orders and should verify that such information is current and complete. All semiconductor products (also referred to herein as "components") are sold subject to TI's terms and conditions of sale supplied at the time of order acknowledgment.

TI warrants performance of its components to the specifications applicable at the time of sale, in accordance with the warranty in TI's terms and conditions of sale of semiconductor products. Testing and other quality control techniques are used to the extent TI deems necessary to support this warranty. Except where mandated by applicable law, testing of all parameters of each component is not necessarily performed.

TI assumes no liability for applications assistance or the design of Buyers' products. Buyers are responsible for their products and applications using TI components. To minimize the risks associated with Buyers' products and applications, Buyers should provide adequate design and operating safeguards.

TI does not warrant or represent that any license, either express or implied, is granted under any patent right, copyright, mask work right, or other intellectual property right relating to any combination, machine, or process in which TI components or services are used. Information published by TI regarding third-party products or services does not constitute a license to use such products or services or a warranty or endorsement thereof. Use of such information may require a license from a third party under the patents or other intellectual property of the third party, or a license from TI under the patents or other intellectual property of TI.

Reproduction of significant portions of TI information in TI data books or data sheets is permissible only if reproduction is without alteration and is accompanied by all associated warranties, conditions, limitations, and notices. TI is not responsible or liable for such altered documentation. Information of third parties may be subject to additional restrictions.

Resale of TI components or services with statements different from or beyond the parameters stated by TI for that component or service voids all express and any implied warranties for the associated TI component or service and is an unfair and deceptive business practice. TI is not responsible or liable for any such statements.

Buyer acknowledges and agrees that it is solely responsible for compliance with all legal, regulatory and safety-related requirements concerning its products, and any use of TI components in its applications, notwithstanding any applications-related information or support that may be provided by TI. Buyer represents and agrees that it has all the necessary expertise to create and implement safeguards which anticipate dangerous consequences of failures, monitor failures and their consequences, lessen the likelihood of failures that might cause harm and take appropriate remedial actions. Buyer will fully indemnify TI and its representatives against any damages arising out of the use of any TI components in safety-critical applications.

In some cases, TI components may be promoted specifically to facilitate safety-related applications. With such components, TI's goal is to help enable customers to design and create their own end-product solutions that meet applicable functional safety standards and requirements. Nonetheless, such components are subject to these terms.

No TI components are authorized for use in FDA Class III (or similar life-critical medical equipment) unless authorized officers of the parties have executed a special agreement specifically governing such use.

Only those TI components which TI has specifically designated as military grade or "enhanced plastic" are designed and intended for use in military/aerospace applications or environments. Buyer acknowledges and agrees that any military or aerospace use of TI components which have **not** been so designated is solely at the Buyer's risk, and that Buyer is solely responsible for compliance with all legal and regulatory requirements in connection with such use.

TI has specifically designated certain components as meeting ISO/TS16949 requirements, mainly for automotive use. In any case of use of non-designated products, TI will not be responsible for any failure to meet ISO/TS16949.

Products

Audio	www.ti.com/audio
Amplifiers	amplifier.ti.com
Data Converters	dataconverter.ti.com
DLP® Products	www.dlp.com
DSP	dsp.ti.com
Clocks and Timers	www.ti.com/clocks
Interface	interface.ti.com
Logic	logic.ti.com
Power Mgmt	power.ti.com
Microcontrollers	microcontroller.ti.com
RFID	www.ti-rfid.com
OMAP Applications Processors	www.ti.com/omap
Wireless Connectivity	www.ti.com/wirelessconnectivity

Applications

Automotive and Transportation	www.ti.com/automotive
Communications and Telecom	www.ti.com/communications
Computers and Peripherals	www.ti.com/computers
Consumer Electronics	www.ti.com/consumer-apps
Energy and Lighting	www.ti.com/energy
Industrial	www.ti.com/industrial
Medical	www.ti.com/medical
Security	www.ti.com/security
Space, Avionics and Defense	www.ti.com/space-avionics-defense
Video and Imaging	www.ti.com/video

TI E2E Community

e2e.ti.com

AMEYA360

Components Supply Platform

Authorized Distribution Brand :



Website :

Welcome to visit www.ameya360.com

Contact Us :

➤ Address :

401 Building No.5, JiuGe Business Center, Lane 2301, Yishan Rd
Minhang District, Shanghai , China

➤ Sales :

Direct +86 (21) 6401-6692

Email amall@ameya360.com

QQ 800077892

Skype [ameyasales1](#) [ameyasales2](#)

➤ Customer Service :

Email service@ameya360.com

➤ Partnership :

Tel +86 (21) 64016692-8333

Email mkt@ameya360.com