

Heterojunction Bipolar Transistor Technology (InGaP HBT)

Broadband High Linearity Amplifier

The MMG3012NT1 is a general purpose amplifier that is internally input matched and internally output matched. It is designed for a broad range of Class A, small-signal, high linearity, general purpose applications. It is suitable for applications with frequencies from 0 to 6000 MHz such as cellular, PCS, BWA, WLL, PHS, CATV, VHF, UHF, UMTS and general small-signal RF.

Features

- Frequency: 0–6000 MHz
- P1dB: 18.5 dBm @ 900 MHz
- Small-Signal Gain: 19 dB @ 900 MHz
- Third Order Output Intercept Point: 34 dBm @ 900 MHz
- Single 5 V Supply
- Internally Matched to 50 Ohms
- Cost-effective SOT-89 Surface Mount Plastic Package
- In Tape and Reel. T1 Suffix = 1,000 Units, 12 mm Tape Width, 7-inch Reel.

MMG3012NT1

**0–6000 MHz, 19 dB
18.5 dBm
InGaP HBT GPA**



SOT-89

Table 1. Typical Performance (1)

Characteristic	Symbol	900 MHz	2140 MHz	3500 MHz	Unit
Small-Signal Gain (S21)	G_p	19	15.8	13.4	dB
Input Return Loss (S11)	IRL	-18	-20	-17	dB
Output Return Loss (S22)	ORL	-18	-12	-16	dB
Power Output @1dB Compression	P1dB	18.5	19	18	dBm
Third Order Output Intercept Point	OIP3	34	32	31	dBm

1. $V_{CC} = 5$ Vdc, $T_A = 25^\circ\text{C}$, 50 ohm system.

Table 2. Maximum Ratings

Rating	Symbol	Value	Unit
Supply Voltage	V_{CC}	7	V
Supply Current	I_{CC}	300	mA
RF Input Power	P_{in}	25	dBm
Storage Temperature Range	T_{stg}	-65 to +150	$^\circ\text{C}$
Junction Temperature	T_J	175	$^\circ\text{C}$

Table 3. Thermal Characteristics

Characteristic	Symbol	Value (2)	Unit
Thermal Resistance, Junction to Case Case Temperature 88 $^\circ\text{C}$, 5 Vdc, 70 mA, no RF applied	$R_{\theta JC}$	85	$^\circ\text{C/W}$

2. Refer to AN1955, *Thermal Measurement Methodology of RF Power Amplifiers*. Go to <http://www.freescale.com/rf>.
Select Documentation/Application Notes - AN1955.

Table 4. Electrical Characteristics ($V_{CC} = 5$ Vdc, 900 MHz, $T_A = 25^\circ\text{C}$, 50 ohm system, in Freescale Application Circuit)

Characteristic	Symbol	Min	Typ	Max	Unit
Small-Signal Gain (S21)	G_p	17.5	19	—	dB
Input Return Loss (S11)	IRL	—	-18	—	dB
Output Return Loss (S22)	ORL	—	-18	—	dB
Power Output @ 1dB Compression	P1dB	—	18.5	—	dBm
Third Order Output Intercept Point	OIP3	—	34	—	dBm
Noise Figure	NF	—	3.8	—	dB
Supply Current	I_{CC}	58	70	82	mA
Supply Voltage	V_{CC}	—	5	—	V

Table 5. Functional Pin Description

Pin Number	Pin Function
1	RF_{in}
2	Ground
3	RF_{out}/DC Supply

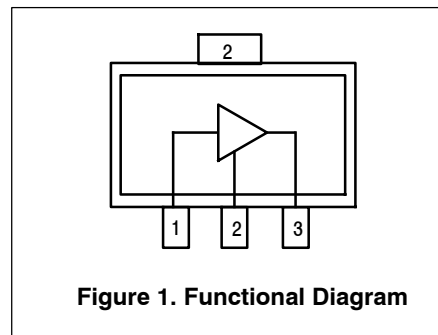
**Table 6. ESD Protection Characteristics**

Test Methodology	Class
Human Body Model (per JESD 22-A114)	1A
Machine Model (per EIA/JESD 22-A115)	A
Charge Device Model (per JESD 22-C101)	IV

Table 7. Moisture Sensitivity Level

Test Methodology	Rating	Package Peak Temperature	Unit
Per JESD 22-A113, IPC/JEDEC J-STD-020	1	260	$^\circ\text{C}$

50 OHM TYPICAL CHARACTERISTICS

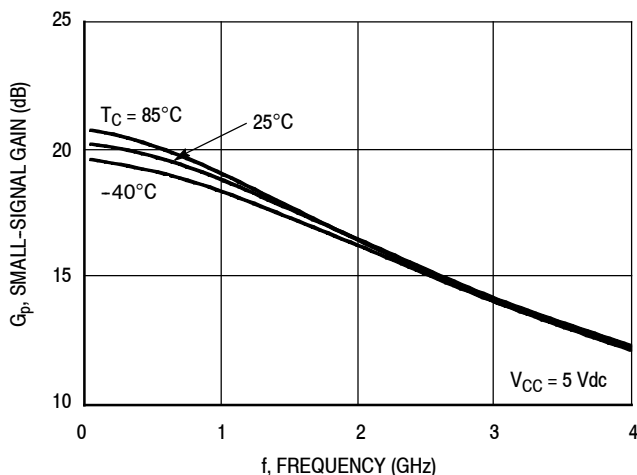

Figure 2. Small-Signal Gain (S21) versus Frequency

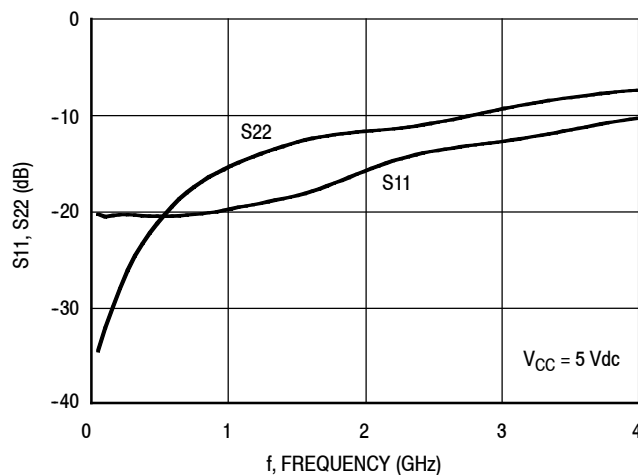

Figure 3. Input/Output Return Loss versus Frequency

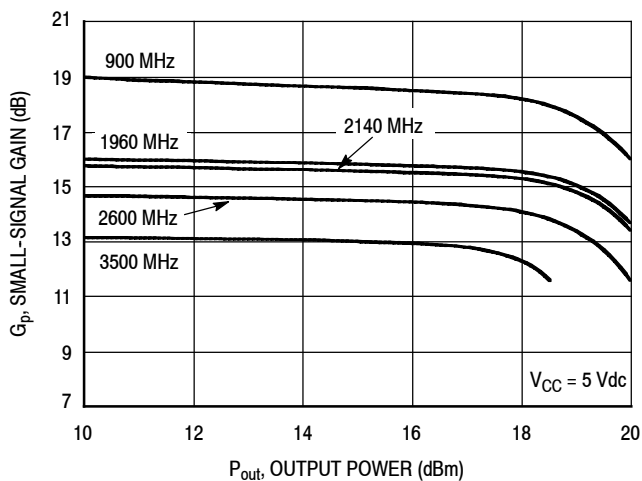

Figure 4. Small-Signal Gain versus Output Power

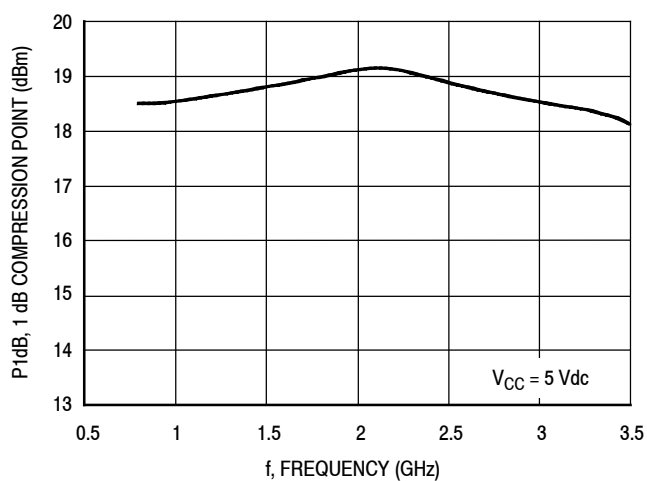

Figure 5. P1dB versus Frequency

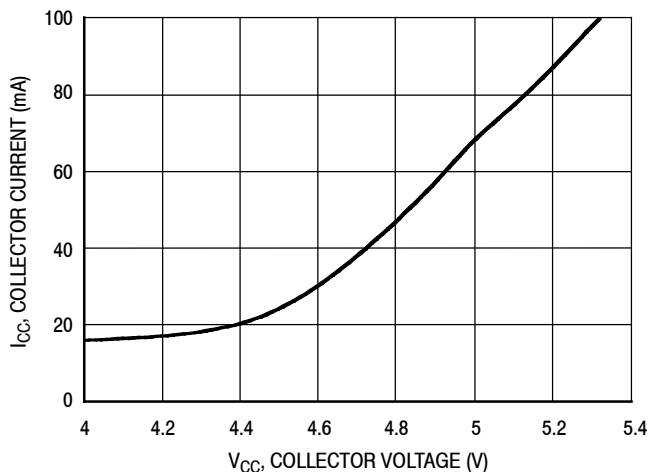

Figure 6. Collector Current versus Collector Voltage

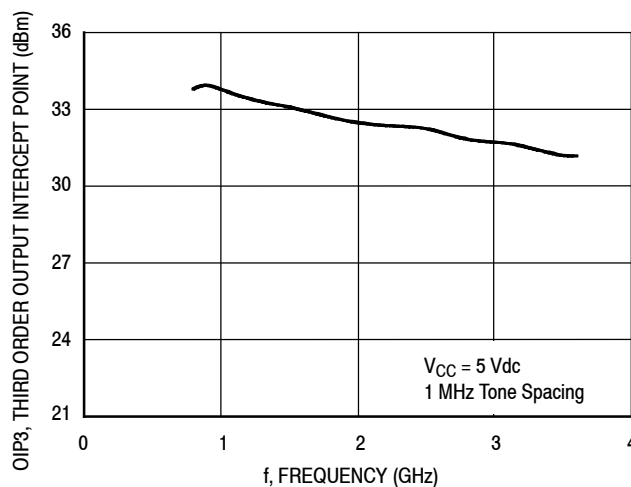

Figure 7. Third Order Output Intercept Point versus Frequency

50 OHM TYPICAL CHARACTERISTICS

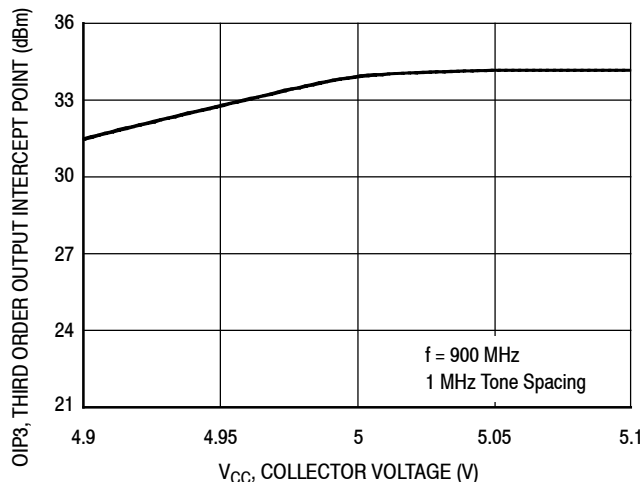

Figure 8. Third Order Output Intercept Point versus Collector Voltage

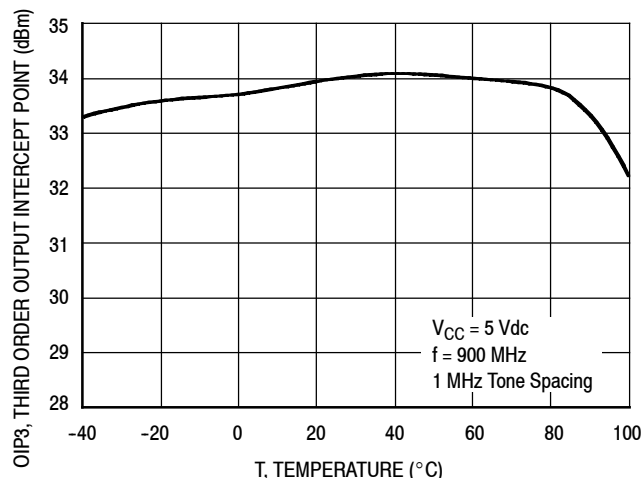

Figure 9. Third Order Output Intercept Point versus Case Temperature

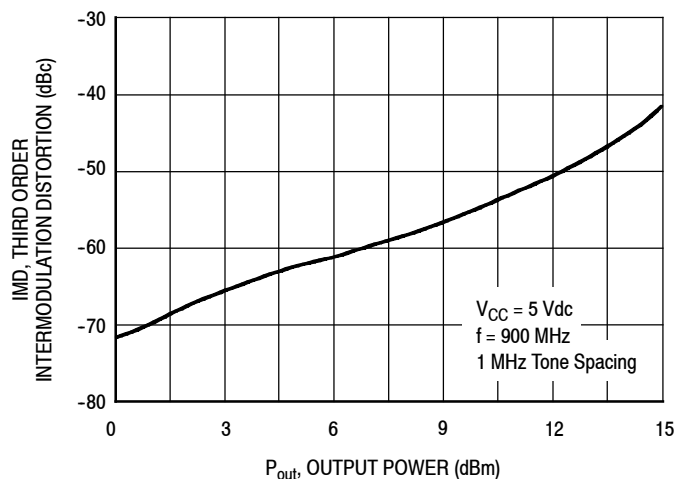
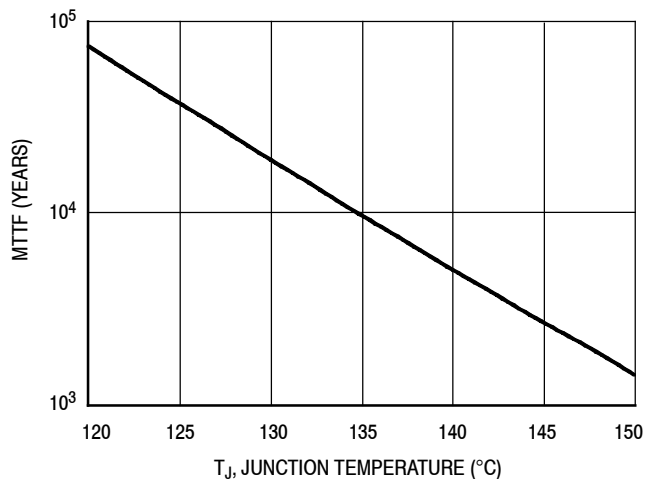

Figure 10. Third Order Intermodulation Distortion versus Output Power



NOTE: The MTTF is calculated with $V_{CC} = 5 \text{ Vdc}$, $I_{CC} = 70 \text{ mA}$

Figure 11. MTTF versus Junction Temperature

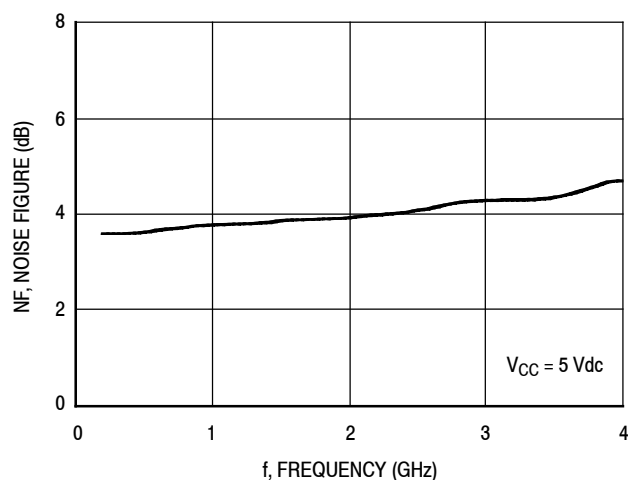

Figure 12. Noise Figure versus Frequency

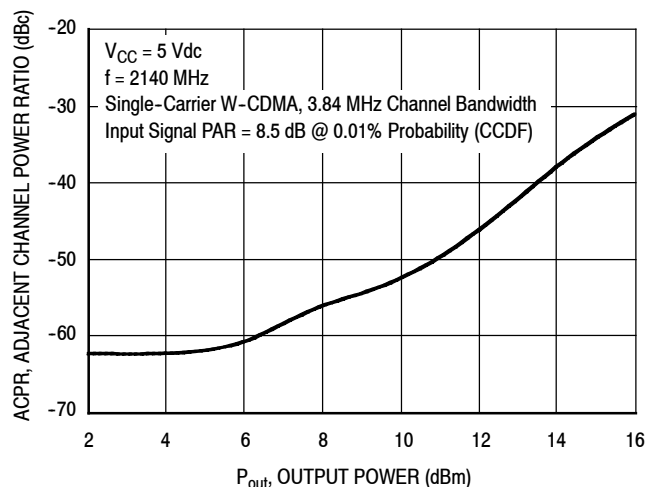

Figure 13. Single-Carrier W-CDMA Adjacent Channel Power Ratio versus Output Power

50 OHM APPLICATION CIRCUIT: 40-300 MHz

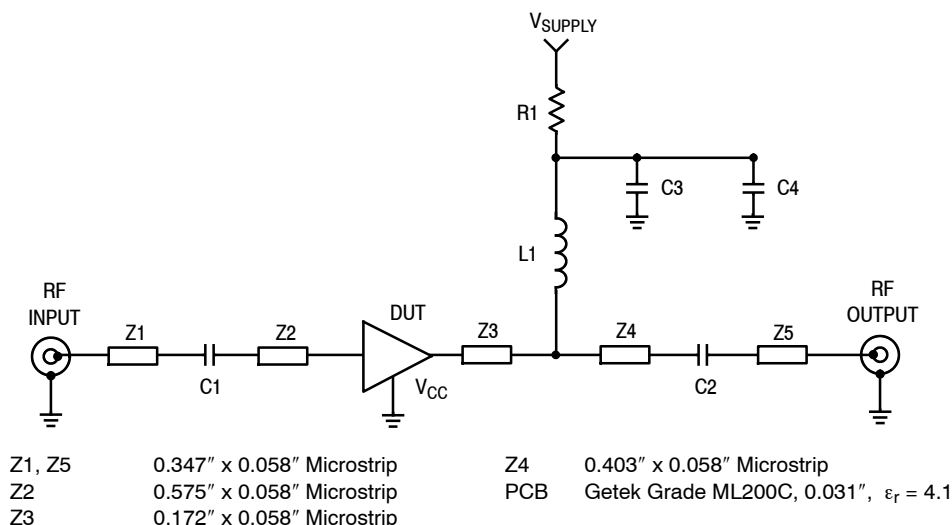

Figure 14. 50 Ohm Test Circuit Schematic

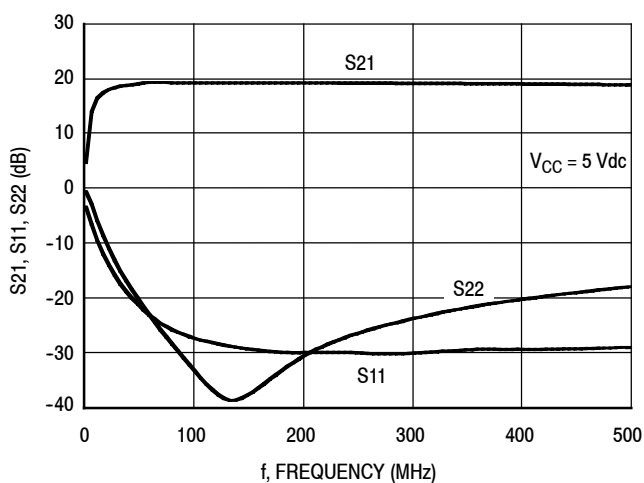

Figure 15. S21, S11 and S22 versus Frequency

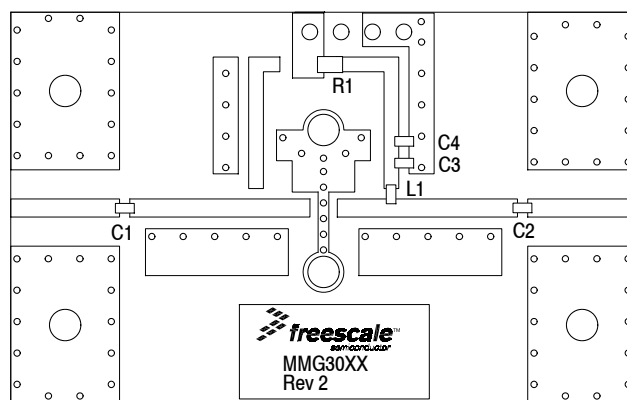

Figure 16. 50 Ohm Test Circuit Component Layout

Table 8. 50 Ohm Test Circuit Component Designations and Values

Part	Description	Part Number	Manufacturer
C1, C2, C3	0.01 μ F Chip Capacitors	C0603C103J5RAC	Kemet
C4	1000 pF Chip Capacitor	C0603C102J5RAC	Kemet
L1	470 nH Chip Inductor	BK2125HM471-T	Taiyo Yuden
R1	0 Ω Chip Resistor	ERJ3GEY0R00V	Panasonic

50 OHM APPLICATION CIRCUIT: 300-3600 MHz

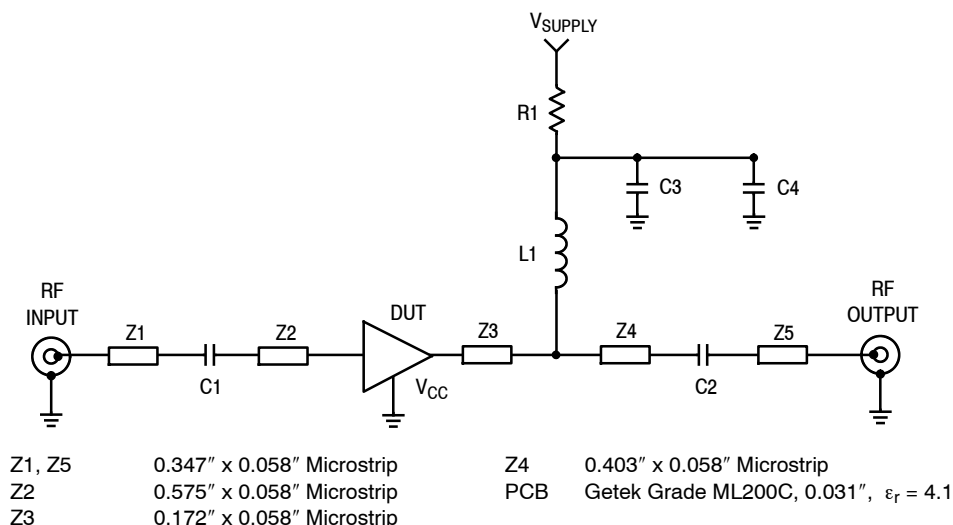

Figure 17. 50 Ohm Test Circuit Schematic

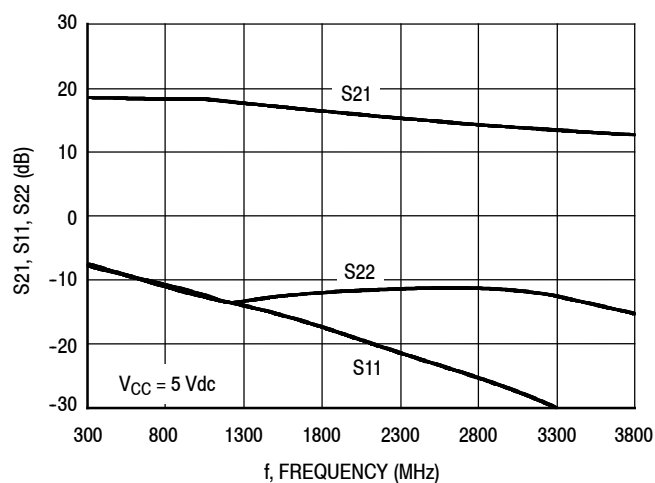

Figure 18. S21, S11 and S22 versus Frequency

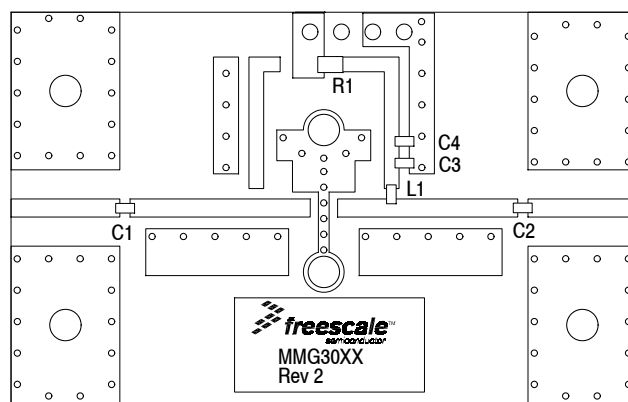

Figure 19. 50 Ohm Test Circuit Component Layout

Table 9. 50 Ohm Test Circuit Component Designations and Values

Part	Description	Part Number	Manufacturer
C1, C2	150 pF Chip Capacitors	C0603C151J5RAC	Kemet
C3	0.01 μ F Chip Capacitor	C0603C103J5RAC	Kemet
C4	1000 pF Chip Capacitor	C0603C102J5RAC	Kemet
L1	56 nH Chip Inductor	HK160856NJ-T	Taiyo Yuden
R1	0 Ω Chip Resistor	ERJ3GEY0R00V	Panasonic

50 OHM TYPICAL CHARACTERISTICS

Table 10. Common Emitter S-Parameters ($V_{CC} = 5 \text{ Vdc}$, $T_A = 25^\circ\text{C}$, 50 Ohm System)

f MHz	S ₁₁		S ₂₁		S ₁₂		S ₂₂	
	S ₁₁	∠ φ	S ₂₁	∠ φ	S ₁₂	∠ φ	S ₂₂	∠ φ
100	0.09174	174.872	10.24140	174.57	0.07096	0.256	0.02426	-90.895
150	0.09324	173.141	10.19244	171.29	0.07214	-0.171	0.03097	-92.768
200	0.09550	172.602	10.14549	168.278	0.07255	-0.477	0.03654	-94.818
250	0.09721	171.41	10.09679	165.627	0.07316	-0.245	0.04935	-96.31
300	0.09703	170.357	10.03727	162.828	0.07333	-0.227	0.06092	-98.961
350	0.09452	169.626	9.99063	159.887	0.07362	-0.511	0.06932	-101.516
400	0.09430	168.366	9.92113	157.15	0.07387	-0.509	0.08063	-104.01
450	0.09343	167.117	9.84672	154.424	0.07402	-0.582	0.09043	-106.263
500	0.09237	166.034	9.77362	151.64	0.07435	-0.77	0.09911	-108.791
550	0.09271	164.864	9.68901	148.973	0.07457	-0.953	0.10788	-111.052
600	0.09245	163.824	9.60244	146.3	0.07487	-0.984	0.11655	-113.69
650	0.09228	162.689	9.51098	143.642	0.07531	-1.158	0.12425	-116.435
700	0.09283	161.228	9.41347	141.059	0.07577	-1.362	0.13246	-119.102
750	0.09352	159.955	9.31713	138.481	0.07608	-1.566	0.13942	-121.839
800	0.09460	158.511	9.21226	135.934	0.07652	-1.748	0.14612	-124.764
850	0.09591	157.224	9.10650	133.403	0.07698	-1.988	0.15280	-127.579
900	0.09731	155.828	9.00381	130.913	0.07747	-2.17	0.15946	-130.497
950	0.09918	154.356	8.89589	128.468	0.07786	-2.552	0.16560	-133.648
1000	0.10165	153.21	8.79066	126.065	0.07831	-2.748	0.17180	-136.717
1050	0.10456	151.519	8.67809	123.674	0.07892	-3.106	0.17724	-139.644
1100	0.10530	150.349	8.55853	121.296	0.07939	-3.413	0.18362	-142.827
1150	0.10595	149.493	8.43942	118.934	0.07997	-3.734	0.18945	-146.154
1200	0.10816	148.216	8.32401	116.631	0.08032	-4.033	0.19501	-149.409
1250	0.11046	147.031	8.21004	114.349	0.08086	-4.47	0.20058	-152.438
1300	0.11249	145.868	8.10074	112.14	0.08142	-4.792	0.20635	-155.584
1350	0.11403	144.558	7.98739	109.93	0.08202	-5.279	0.21190	-158.664
1400	0.11488	143.211	7.87293	107.781	0.08247	-5.657	0.21733	-161.631
1450	0.11602	142.244	7.75891	105.625	0.08302	-6.021	0.22271	-164.745
1500	0.11686	136.948	7.66911	103.599	0.08384	-6.437	0.23416	-166.394
1550	0.11834	134.929	7.55873	101.565	0.08447	-6.947	0.23853	-169.432
1600	0.12187	132.851	7.45808	99.538	0.08501	-7.329	0.24236	-172.577
1650	0.12645	130.925	7.35252	97.533	0.08565	-7.818	0.24526	-175.475
1700	0.13047	129.243	7.26057	95.548	0.08616	-8.268	0.24807	-178.453
1750	0.13472	127.648	7.16564	93.586	0.08673	-8.83	0.25113	178.712
1800	0.13990	126.06	7.06852	91.625	0.08733	-9.205	0.25379	175.901
1850	0.14563	124.504	6.96617	89.685	0.08792	-9.856	0.25623	173.194
1900	0.15160	122.941	6.86978	87.806	0.08860	-10.316	0.25716	170.619
1950	0.15702	121.556	6.77908	85.927	0.08917	-10.882	0.25848	168.384
2000	0.16308	120.247	6.68747	84.024	0.08980	-11.465	0.25937	166.234
2050	0.16757	118.779	6.60108	82.171	0.09037	-12.048	0.26021	164.169
2100	0.17315	117.547	6.51391	80.255	0.09093	-12.637	0.26130	162.354
2150	0.17857	116.463	6.42737	78.424	0.09154	-13.316	0.26314	160.699
2200	0.18449	115.174	6.33611	76.56	0.09210	-13.944	0.26471	159.323
2250	0.18892	113.697	6.24887	74.732	0.09280	-14.673	0.26627	157.768

(continued)

MMG3012NT1

50 OHM TYPICAL CHARACTERISTICS

Table 10. Common Emitter S-Parameters ($V_{CC} = 5 \text{ Vdc}$, $T_A = 25^\circ\text{C}$, 50 Ohm System) (continued)

f MHz	S ₁₁		S ₂₁		S ₁₂		S ₂₂	
	S ₁₁	∠ φ	S ₂₁	∠ φ	S ₁₂	∠ φ	S ₂₂	∠ φ
2300	0.19385	112.219	6.16340	72.929	0.09326	-15.366	0.26829	156.541
2350	0.19754	110.678	6.07930	71.134	0.09383	-16.084	0.27135	155.373
2400	0.20084	109.125	5.99646	69.327	0.09424	-16.717	0.27492	154.124
2450	0.20423	107.523	5.91022	67.546	0.09462	-17.459	0.27881	153.075
2500	0.20717	105.937	5.82783	65.858	0.09514	-18.149	0.28300	151.824
2550	0.20983	104.482	5.75180	64.078	0.09561	-18.867	0.28750	150.28
2600	0.21214	102.92	5.67379	62.378	0.09610	-19.566	0.29276	148.947
2650	0.21446	101.252	5.59418	60.667	0.09647	-20.335	0.29839	147.403
2700	0.21638	99.767	5.51853	58.949	0.09688	-21.012	0.30389	145.776
2750	0.21837	98.143	5.44472	57.276	0.09737	-21.79	0.30941	143.933
2800	0.22001	96.523	5.37675	55.629	0.09779	-22.573	0.31537	142.001
2850	0.22117	95.017	5.30584	53.932	0.09840	-23.199	0.32118	140.215
2900	0.22351	93.331	5.24121	52.348	0.09877	-24.027	0.32764	138.273
2950	0.22552	91.634	5.17536	50.712	0.09912	-24.843	0.33369	136.168
3000	0.22752	90.219	5.11494	49.089	0.09981	-25.546	0.34034	134.188
3050	0.23097	88.535	5.05825	47.462	0.10036	-26.365	0.34528	132.091
3100	0.23369	87.054	4.99713	45.82	0.10085	-27.171	0.35126	129.624
3150	0.23656	85.789	4.94222	44.188	0.10141	-27.968	0.35690	127.421
3200	0.23989	84.265	4.88930	42.551	0.10188	-28.842	0.36188	125.127
3250	0.24360	82.93	4.83457	40.954	0.10239	-29.629	0.36735	122.986
3300	0.24688	81.534	4.78423	39.327	0.10292	-30.452	0.37180	120.634
3350	0.25052	80.161	4.73023	37.654	0.10350	-31.434	0.37649	118.449
3400	0.25455	78.818	4.68010	36.023	0.10402	-32.349	0.38152	116.317
3450	0.25901	77.562	4.63102	34.476	0.10446	-33.239	0.38553	114.07
3500	0.26341	76.264	4.58330	32.823	0.10504	-34.166	0.39006	112.169
3550	0.26813	74.959	4.53327	31.168	0.10524	-35.066	0.39457	110.035
3600	0.27237	73.713	4.48601	29.586	0.10576	-36.008	0.39878	107.887

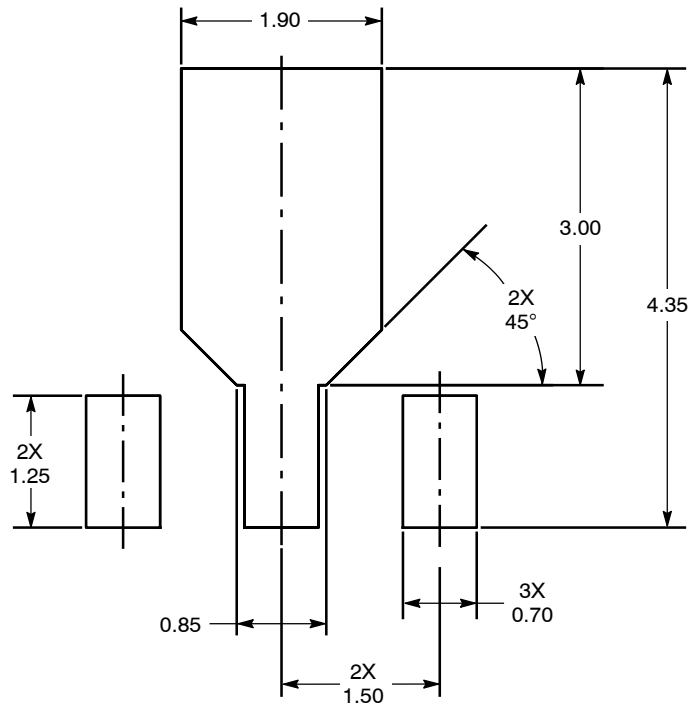

Figure 20. PCB Pad Layout for SOT-89A

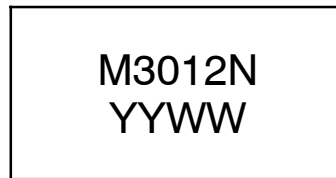
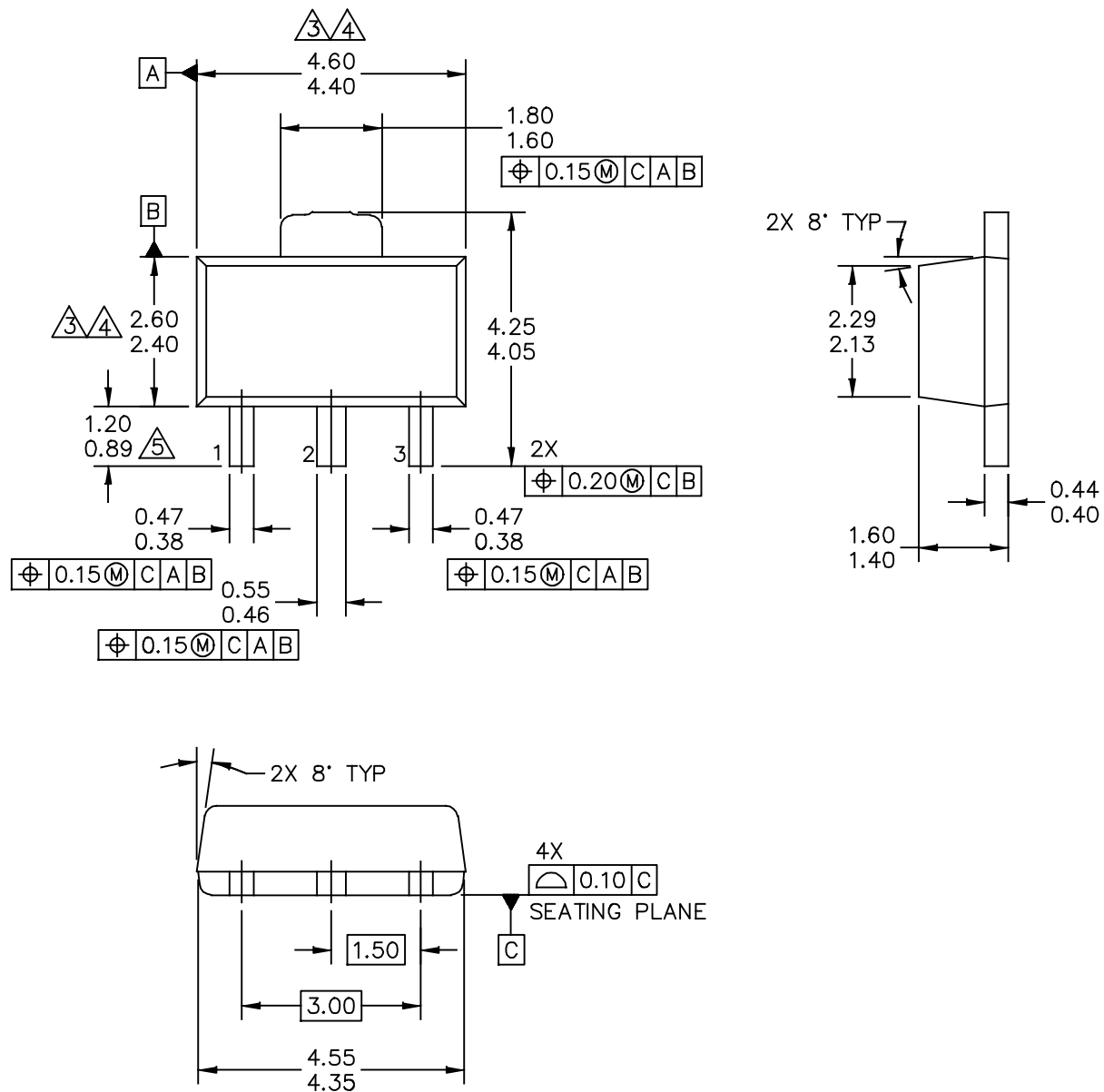
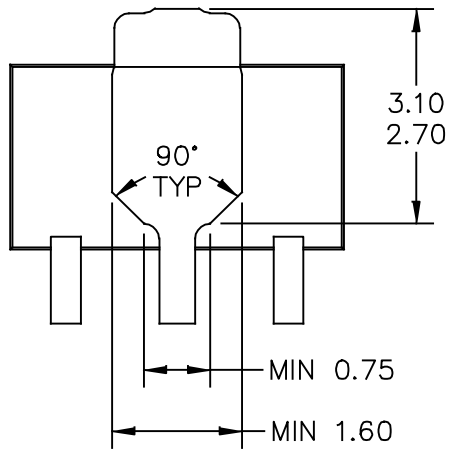

Figure 21. Product Marking

PACKAGE DIMENSIONS



© FREESCALE SEMICONDUCTOR, INC. ALL RIGHTS RESERVED.	MECHANICAL OUTLINE	PRINT VERSION NOT TO SCALE	
TITLE: SOT-89A, 3 LEAD, 4.5 X 2.5 PKG, 1.5 MM PITCH	DOCUMENT NO: 98ASA00241D	REV: 0	
	CASE NUMBER: 2142-01	15 JUL 2010	
	STANDARD: NON-JEDEC		



BOTTOM VIEW

© FREESCALE SEMICONDUCTOR, INC. ALL RIGHTS RESERVED.	MECHANICAL OUTLINE	PRINT VERSION NOT TO SCALE	
TITLE: SOT-89A, 3 LEAD, 4.5 X 2.5 PKG, 1.5 MM PITCH	DOCUMENT NO: 98ASA00241D	REV: 0	
	CASE NUMBER: 2142-01	15 JUL 2010	
	STANDARD: NON-JEDEC		

NOTES:

1. DIMENSIONING AND TOLERANCING PER ASME Y14.5M – 1994.

2. ALL DIMENSIONS ARE IN MILLIMETERS.

3. DIMENSIONS DOES NOT INCLUDE MOLD FLASH. PROTRUSIONS OR GATE BURRS. MOLD FLASH, PROTRUSIONS OR GATE BURRS SHALL NOT EXCEED 0.5 MM PER END. DIMENSION DOES NOT INCLUDE INTERLEAD FLASH OR PROTRUSION. INTERLEAD FLASH OR PROTRUSION SHALL NOT EXCEED 0.5 MM PER SIDE.

4. DIMENSION ARE DETERMINED AT THE OUTMOST EXTREMES OF THE PLASTIC BODY EXCLUSIVE OF MOLD FLASH, TIE BAR BURRS, GATE BURRS AND INTERLEAD FLASH, BUT INCLUDING ANY MISMATCH BETWEEN THE TOP AND BOTTOM OF THE PLASTIC BODY.

5. TERMINAL NUMBERS ARE SHOWN FOR REFERENCE ONLY.

© FREESCALE SEMICONDUCTOR, INC. ALL RIGHTS RESERVED.	MECHANICAL OUTLINE	PRINT VERSION NOT TO SCALE	
TITLE: SOT-89A, 3 LEAD, 4.5 X 2.5 PKG, 1.5 MM PITCH	DOCUMENT NO: 98ASA00241D	REV: 0	
	CASE NUMBER: 2142-01	15 JUL 2010	
	STANDARD: NON-JEDEC		

PRODUCT DOCUMENTATION, SOFTWARE AND TOOLS

Refer to the following resources to aid your design process.

Application Notes

- AN1955: Thermal Measurement Methodology of RF Power Amplifiers
- AN3100: General Purpose Amplifier and MMIC Biasing

Software

- .s2p File

Development Tools

- Printed Circuit Boards

For Software and Tools, do a Part Number search at <http://www.freescale.com>, and select the “Part Number” link. Go to Software & Tools on the part’s Product Summary page to download the respective tool.

FAILURE ANALYSIS

At this time, because of the physical characteristics of the part, failure analysis is limited to electrical signature analysis. In cases where Freescale is contractually obligated to perform failure analysis (FA) services, full FA may be performed by third party vendors with moderate success. For updates contact your local Freescale Sales Office.

REVISION HISTORY

The following table summarizes revisions to this document.

Revision	Date	Description
3	Mar. 2007	<ul style="list-style-type: none">• Corrected and updated Part Numbers in Tables 8 and 9, Component Designations and Values, to RoHS compliant part numbers, pp. 6, 7
4	July 2007	<ul style="list-style-type: none">• Replaced Case Outline 1514-01 with 1514-02, Issue D, pp. 1, 11-13. Case updated to add missing dimension for Pin 1 and Pin 3.
5	Mar. 2008	<ul style="list-style-type: none">• Removed Footnote 2, Continuous voltage and current applied to device, from Table 2, Maximum Ratings, p. 1• Corrected Fig. 13, Single-Carrier W-CDMA Adjacent Channel Power Ratio versus Output Power y-axis (ACPR) unit of measure to dBc, p. 5• Corrected S-Parameter table frequency column label to read “MHz” versus “GHz” and corrected frequency values from GHz to MHz, pp. 8, 9
6	Feb. 2012	<ul style="list-style-type: none">• Corrected temperature at which Theta_{JC} is measured from 25°C to 88°C and added “no RF applied” to Thermal Characteristics table to indicate that thermal characterization is performed under DC test with no RF signal applied, p. 1• Table 6, ESD Protection Characteristics, removed the word “Minimum” after the ESD class rating. ESD ratings are characterized during new product development but are not 100% tested during production. ESD ratings provided in the data sheet are intended to be used as a guideline when handling ESD sensitive devices, p. 3• Removed I_{CC} bias callout from applicable graphs and Table 10, Common Emitter S-Parameters heading as bias is not a controlled value, pp. 4-9• Added .s2p File availability to Product Software and Printed Circuit Boards to Development Tools, p. 14
7	Apr. 2012	<ul style="list-style-type: none">• Table 1, Maximum Ratings, increased Input Power from 10 dBm to 25 dBm to reflect the true capability of the device, p. 1
8	Sept. 2014	<ul style="list-style-type: none">• Replaced the PCB Pad Layout drawing, the package image and mechanical outline for Case 1514-02 (SOT-89) with Case 2142-01 (SOT-89) as a result of the device transfer from a Freescale wafer fab to an external GaAs wafer fab and new assembly site. The new assembly and test site’s SOT-89 package has slight dimensional differences, pp. 1, 9-12. Refer to PCN13337, <i>GaAs Fab Transfer</i>.• Table 2, Maximum Ratings: updated Junction Temperature from 150°C to 175°C to reflect recent test results of the device, p. 1• Added Fig. 21, Product Marking, p. 9• Added Failure Analysis information, p. 13

How to Reach Us:

Home Page:
freescale.com

Web Support:
freescale.com/support

Information in this document is provided solely to enable system and software implementers to use Freescale products. There are no express or implied copyright licenses granted hereunder to design or fabricate any integrated circuits based on the information in this document.

Freescale reserves the right to make changes without further notice to any products herein. Freescale makes no warranty, representation, or guarantee regarding the suitability of its products for any particular purpose, nor does Freescale assume any liability arising out of the application or use of any product or circuit, and specifically disclaims any and all liability, including without limitation consequential or incidental damages. "Typical" parameters that may be provided in Freescale data sheets and/or specifications can and do vary in different applications, and actual performance may vary over time. All operating parameters, including "typicals," must be validated for each customer application by customer's technical experts. Freescale does not convey any license under its patent rights nor the rights of others. Freescale sells products pursuant to standard terms and conditions of sale, which can be found at the following address: freescale.com/SalesTermsandConditions.

Freescale and the Freescale logo are trademarks of Freescale Semiconductor, Inc., Reg. U.S. Pat. & Tm. Off. All other product or service names are the property of their respective owners.

© 2005–2008, 2012, 2014 Freescale Semiconductor, Inc.



AMEYA360

Components Supply Platform

Authorized Distribution Brand :



Website :

Welcome to visit www.ameya360.com

Contact Us :

➤ Address :

401 Building No.5, JiuGe Business Center, Lane 2301, Yishan Rd
Minhang District, Shanghai , China

➤ Sales :

Direct +86 (21) 6401-6692

Email amall@ameya360.com

QQ 800077892

Skype [ameyasales1](#) [ameyasales2](#)

➤ Customer Service :

Email service@ameya360.com

➤ Partnership :

Tel +86 (21) 64016692-8333

Email mkt@ameya360.com