

Analog Devices Welcomes Hittite Microwave Corporation

NO CONTENT ON THE ATTACHED DOCUMENT HAS CHANGED



THIS PAGE INTENTIONALLY LEFT BLANK



SMT GaAs MMIC x2 ACTIVE FREQUENCY MULTIPLIER, 27 - 31 GHz OUTPUT

Typical Applications

The HMC577LC4B is suitable for:

- Clock Generation Applications:
SONET OC-192 & SDH STM-64
- Point-to-Point & VSAT Radios
- Test Instrumentation
- Military & Space

Features

- Very High Output Power: +20 dBm
- Low Input Power Drive: -2 to +6 dBm
- Very High Fo, 3Fo Isolation:
>55 dBc @ Fout= 29 GHz
- 100 KHz SSB Phase Noise: -128 dBc/Hz
- Single Supply: +5V @ 213 mA
- 24 Lead 4x4mm QFN Package: 16mm²

Functional Diagram

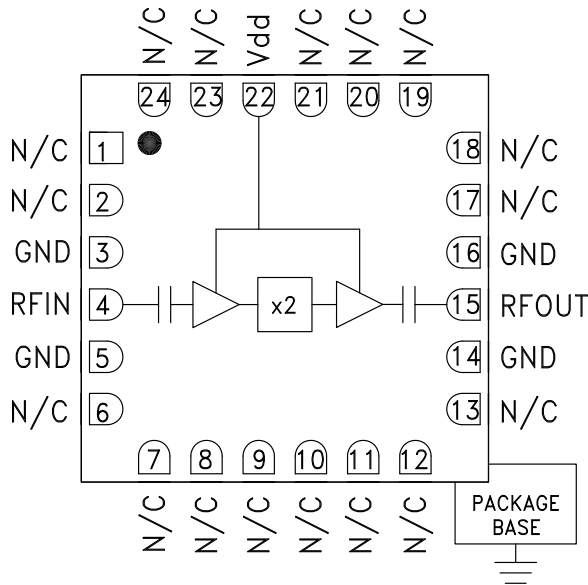

General Description

The HMC577LC4B is a x2 active broadband frequency multiplier utilizing GaAs PHEMT technology in a leadless RoHS compliant SMT package. When driven by a +5 dBm signal, the multiplier provides +20 dBm typical output power from 27 to 31 GHz. The Fo and 3Fo isolations are >55 dBc at 29 GHz. The HMC577LC4B is ideal for use in LO multiplier chains for Pt-to-Pt & VSAT Radios yielding reduced parts count vs. traditional approaches. The low additive SSB Phase Noise of -128 dBc/Hz at 100 kHz offset helps maintain good system noise performance. The RoHS packaged HMC577LC4B eliminates the need for wire bonding, and allows the use of surface mount manufacturing techniques.

Electrical Specifications, $T_A = +25^\circ C$, Vdd = +5V, 5 dBm Drive Level

Parameter	Min.	Typ.	Max.	Units
Frequency Range, Input	13.5 - 15.5			GHz
Frequency Range, Output	27 - 31			GHz
Output Power	15	20		dBm
Fo Isolation (with respect to output level)		60		dBc
3Fo Isolation (with respect to output level)		55		dBc
Input Return Loss		20		dB
Output Return Loss		7		dB
SSB Phase Noise (100 kHz Offset)		-128		dBc/Hz
Supply Current (Idd)		213		mA



SMT GaAs MMIC x2 ACTIVE FREQUENCY MULTIPLIER, 27 - 31 GHz OUTPUT

Output Power vs. Temperature @ 5 dBm Drive Level

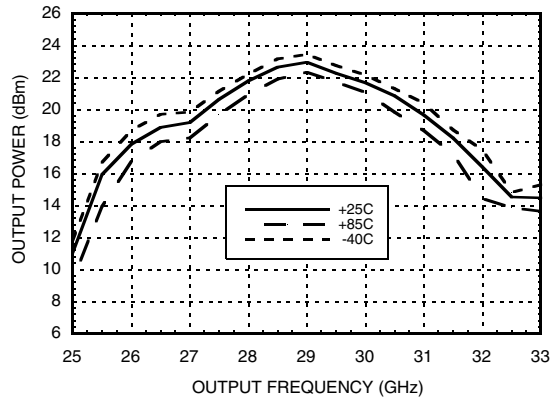

Output Power vs. Drive Level

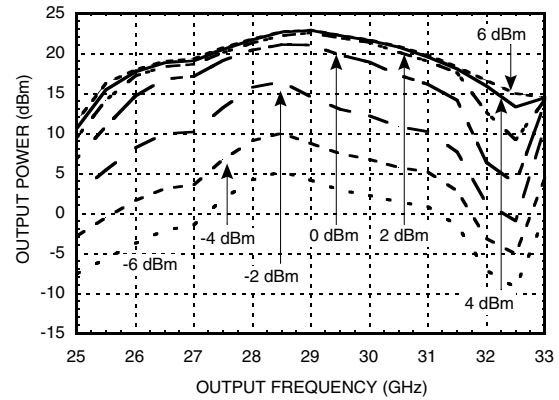

Output Power vs. Supply Voltage @ 5 dBm Drive Level

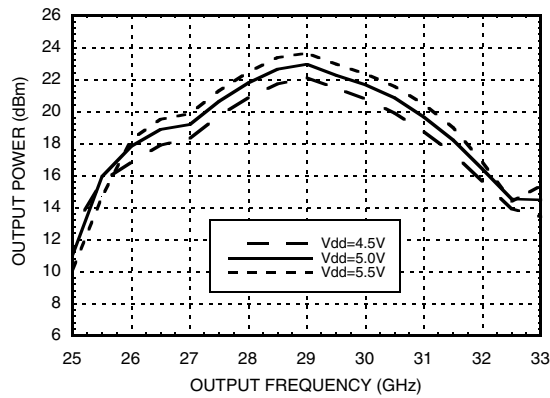

Isolation @ 5 dBm Drive Level

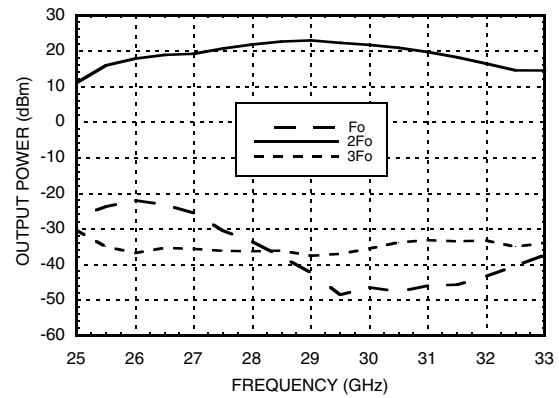

Output Power vs. Input Power

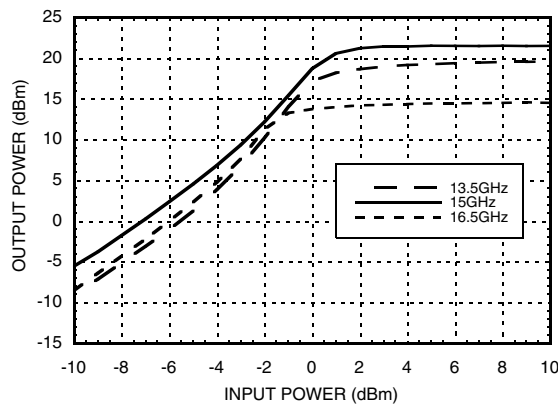

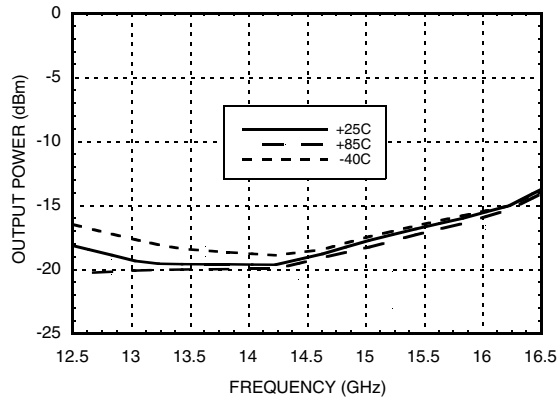
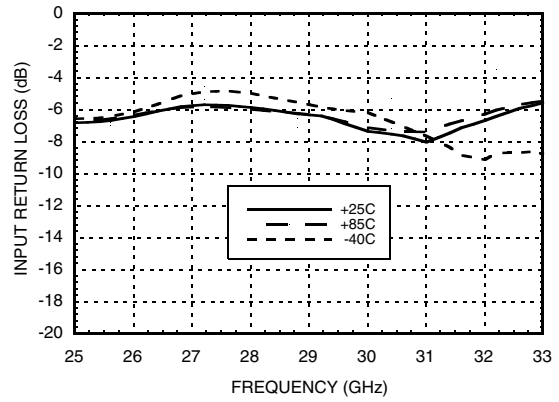
**SMT GaAs MMIC x2 ACTIVE FREQUENCY MULTIPLIER, 27 - 31 GHz OUTPUT****Input Return Loss vs. Temperature****Output Return Loss vs. Temperature**

SMT GaAs MMIC x2 ACTIVE FREQUENCY MULTIPLIER, 27 - 31 GHz OUTPUT
Absolute Maximum Ratings

RF Input (Vdd = +5V)	+13 dBm
Supply Voltage (Vdd)	+6.0 V
Channel Temperature	175 °C
Continuous Pdiss (T= 85 °C) (derate 13.8 mW/°C above 85 °C)	1.24 W
Thermal Resistance (channel to ground paddle)	73 °C/W
Storage Temperature	-65 to +150 °C
Operating Temperature	-40 to +85 °C

Typical Supply Current vs. Vdd

Vdd (Vdc)	Idd (mA)
4.5	212
5.0	213
5.5	214

Note:
Multiplier will operate over full voltage range shown above.

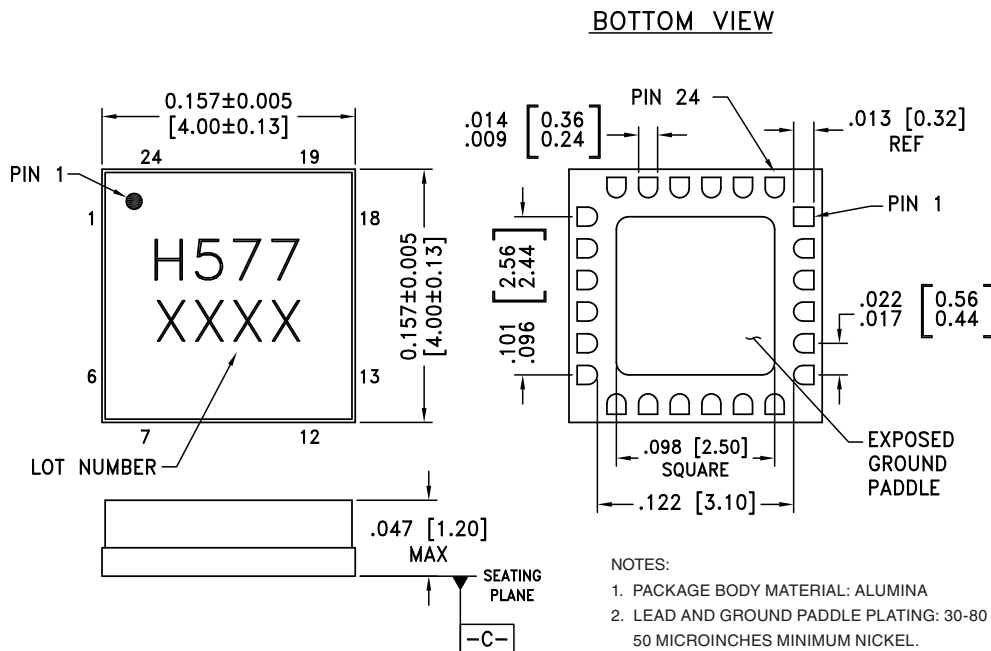

**ELECTROSTATIC SENSITIVE DEVICE
OBSERVE HANDLING PRECAUTIONS**

Outline Drawing

NOTES:

1. PACKAGE BODY MATERIAL: ALUMINA
2. LEAD AND GROUND PADDLE PLATING: 30-80 MICROINCHES GOLD OVER 50 MICROINCHES MINIMUM NICKEL.
3. DIMENSIONS ARE IN INCHES [MILLIMETERS].
4. LEAD SPACING TOLERANCE IS NON-CUMULATIVE
5. PACKAGE WARP SHALL NOT EXCEED 0.05mm DATUM [-C-]
6. ALL GROUND LEADS AND GROUND PADDLE MUST BE SOLDERED TO PCB RF GROUND.

Package Information

Part Number	Package Body Material	Lead Finish	MSL Rating	Package Marking ^[2]
HMC577LC4B	Alumina, White	Gold over Nickel	MSL3 ^[1]	H577 XXXX

[1] Max peak reflow temperature of 260 °C

[2] 4-Digit lot number XXXX



SMT GaAs MMIC x2 ACTIVE FREQUENCY MULTIPLIER, 27 - 31 GHz OUTPUT

Pin Description

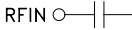
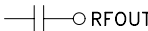
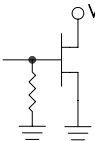
Pin Number	Function	Description	Interface Schematic
1, 2, 6 - 13, 17 - 21, 23, 24	N/C	These pins are internally not connected; however, this product was specified with these pins connected to RF/ DC ground.	
3, 5, 14, 16	GND	Package bottom must also be connected to RF/DC ground.	
4	RFIN	Pin is AC coupled and matched to 50 Ohms.	
15	RFOUT	Pin is AC coupled and matched to 50 Ohms.	
22	Vdd	Supply voltage 5V ± 0.5V. External bypass capacitors of 100 pF, 1,000 pF and 2.2 μF are required.	

Application Circuit

Component	Value
C1	100 pF
C2	1,000 pF
C3	2.2 μF

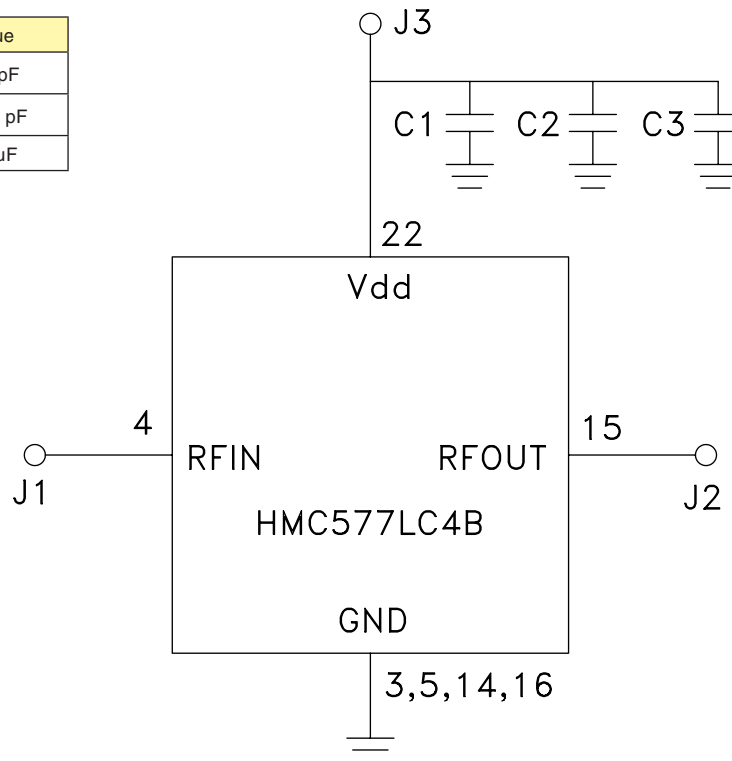



SMT GaAs MMIC x2 ACTIVE FREQUENCY MULTIPLIER, 27 - 31 GHz OUTPUT

Evaluation PCB

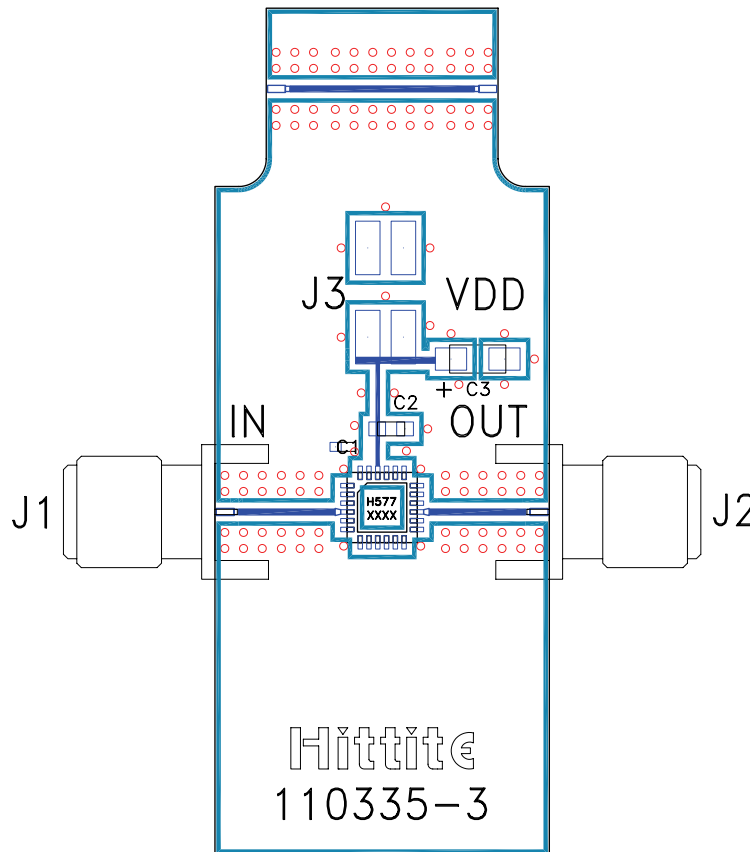

List of Materials for Evaluation PCB 115223 [1]

Item	Description
J1, J2	PCB Mount SRI K Connector
J3	Molex Header, 2mm
C1	100 pF Capacitor, 0402 Pkg.
C2	1,000 pF Capacitor, 0603 Pkg.
C3	2.2 μF Tantalum Capacitor
U1	HMC577LC4B x2 Active Multiplier
PCB [2]	110335 Eval Board

[1] Reference this number when ordering complete evaluation PCB

[2] Circuit Board Material: Rogers 4350

The circuit board used in the final application should be generated with proper RF circuit design techniques. Signal lines should have 50 ohm impedance while the package ground leads and exposed paddle should be connected directly to the ground plane similar to that shown. A sufficient number of via holes should be used to connect the top and bottom ground planes. The evaluation circuit board shown is available from Hittite upon request.

AMEYA360

Components Supply Platform

Authorized Distribution Brand :



Website :

Welcome to visit www.ameya360.com

Contact Us :

➤ Address :

401 Building No.5, JiuGe Business Center, Lane 2301, Yishan Rd
Minhang District, Shanghai , China

➤ Sales :

Direct +86 (21) 6401-6692

Email amall@ameya360.com

QQ 800077892

Skype [ameyasales1](#) [ameyasales2](#)

➤ Customer Service :

Email service@ameya360.com

➤ Partnership :

Tel +86 (21) 64016692-8333

Email mkt@ameya360.com