



SPX2941

1A Low Dropout Voltage Regulator Adjustable Output, Fast Response

FEATURES

- Adjustable Output Down To 1.25V
- Low Quiescent Current
- Guaranteed 1.5A Peak Output Current
- Low Dropout Voltage of 280mV @ 1A
- Extremely Tight Load and Line Regulation
- Extremely Fast Transient Response
- Reverse-battery Protection
- Internal Thermal and Current Limit Protection
- Zero Current Shutdown
- Standard TO-220 and TO-263 packages

Now Available in Lead Free Packaging

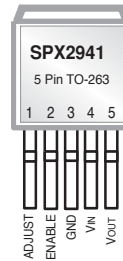

APPLICATIONS

- Powering VGA & Sound Card
- LCD Monitors
- USB Power Supply
- Power PC Supplies
- SMPS Post-Regulator
- High Efficiency Linear Power Supplies
- Battery Charger
- Portable Instrumentation
- Constant Current Regulators
- Adjustable Power Supplies

DESCRIPTION

The SPX2941 is a 1A, accurate voltage regulator with a low drop out voltage of 280mV(typ.) at 1A. These regulators are specifically designed for low voltage applications that require a low dropout voltage and a fast transient response. They are fully fault protected against over-current, reverse battery, and positive and negative voltage transients. The SPX2941 is offered in 5-pin TO-220 & TO-263 packages. For a 3A version, refer to the SPX29300 data sheet.

TYPICAL APPLICATIONS CIRCUIT

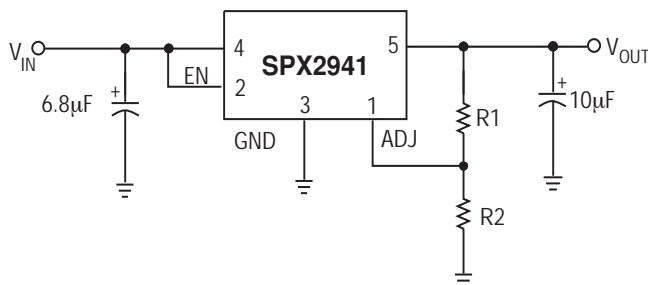

Figure 1. Adjustable Output Linear Regulator

ABSOLUTE MAXIMUM RATINGS

Lead Temperature (soldering, 5 seconds)260°C
Storage Temperature Range.....-65°C to +150°C

Operating Junction Temperature Range.....-40°C to +125°C
Input Supply Voltage (Note6) 16V

ELECTRICAL CHARACTERISTICS

$V_{IN}=V_{OUT}+1V$, $I_{OUT}=10mA$, $C_{IN}=6.8\mu F$, $C_{OUT}=10\mu F$, $T_A=25^\circ C$, unless otherwise specified. The boldface applies over the junction temperature range. Adjustable versions are set at +5.0V.

PARAMETER	CONDITIONS	MIN.	TYP.	MAX	UNIT
Reference Voltage	Adjustable version only	1.228 1.215	1.240	1.252 1.265	V
Adjust Pin Bias Current			40	80 120	V
Reference Voltage Temperature Coefficient	(NOTE4)		20		ppm/°C
Adjust Pin Bias Current Temperature Coefficient			0.1		nA/°C
Line Regulation	$I_{OUT}=10mA$, $(V_{OUT}+1V)\leq V_{IN}\leq 16V$		0.2	1.0	%
Load Regulation	$V_{IN}=V_{OUT}+1V$, $10mA\leq I_{OUT}\leq I_{FULL}$		0.3	1.5	%
Dropout Voltage (Note1) (except 1.8V version)	$I_{OUT}=100mA$ $I_{OUT}=1A$		70 280	200 550	mV
Ground Current (Note3)	$I_{OUT}=750mA$, $V_{IN}=V_{OUT}+1V$ $I_{OUT}=1A$		12 18	25	mA
Ground Pin Current at Dropout	$V_{IN}=0.1V$ less than specified V_{OUT} , $I_{OUT}=10mA$		1.2		mA
Current Limit	$V_{OUT}=0V$ (Note2)	1.5	2.2		A
Output Noise Voltage	10Hz to 100kHz, $I_{OUT}=100mA$, $C_L=10\mu F$ $C_L=33\mu F$		400 260		μV_{RMS}
LOW (OFF) HIGH (ON)	Input Logic Voltage $V_{IN}<10V$	2.4		0.8	V
ENABLE Input Pin Current	$V_{EN}=16V$		100	600 750	μA
	$V_{EN}=0.8V$			1 2	μA
Regulator Output Current in Shutdown	(NOTE5)		10	500	μA
Thermal Resistance TO-220	Junction to Case, at Tab		3		°C/W
	Junction to Ambient		29.3		
TO-263	Junction to Case, at Tab		3		°C/W
	Junction to Ambient		31.2		

NOTE1: Dropout voltage is defined as the input to output differential at which the output voltage drops to 99% of its nominal value.

NOTE2: $V_{IN}=V_{OUT(NOMINAL)}+1V$; for example, $V_{IN}=4.3V$ for a 3.3V regulator. Employ pulse-testing procedures to minimize temperature rise.

NOTE3: Ground pin current is the regulator quiescent current. The total current drawn from the source is the sum of the load and ground currents.

NOTE4: Thermal regulation is defined as the change in the output voltage at a time T after a change in power dissipation is applied, excluding load or line regulation effects.

NOTE5: $V_{EN}\leq 0.8V$ and $V_{IN}\leq 16V$, $V_{OUT}=0$.

NOTE6: Maximum positive supply voltage of 20V must be of limited duration (<100ms) and duty cycle (<1%). The maximum continuous supply voltage is 16V.

NOTE7: $V_{REF}\leq V_{OUT}\leq (V_{IN}-1)$, $2.5V\leq V_{IN}\leq 16V$, $10mA\leq I_C\leq I_{FL}$, $T_J<T_{JMAX}$.

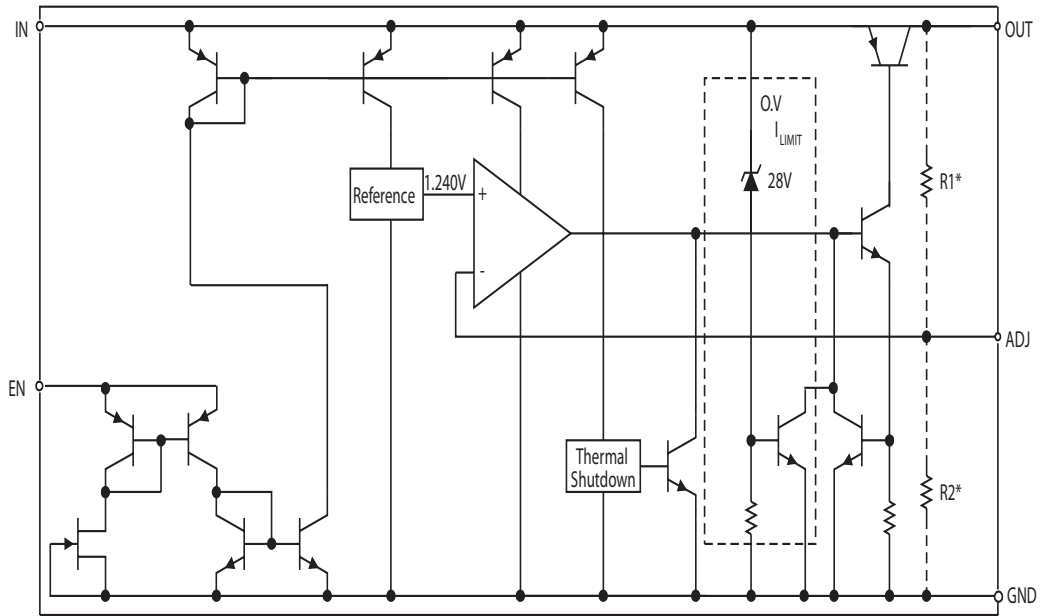
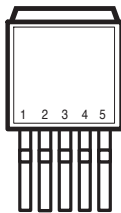

Figure 2. SPX2941 Block Diagram

PACKAGE PINOUTS

TO-263-5 Package (T5)

TO-220-5 Package (U5)



Top View

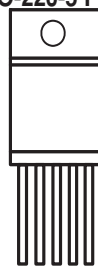

Top View

SPX2941

- 1) ADJUST
- 2) Enable
- 3) GND
- 4) V_{IN}
- 5) V_{OUT}

Note: Tab is internally connected to GND

TYPICAL PERFORMANCE CHARACTERISTICS

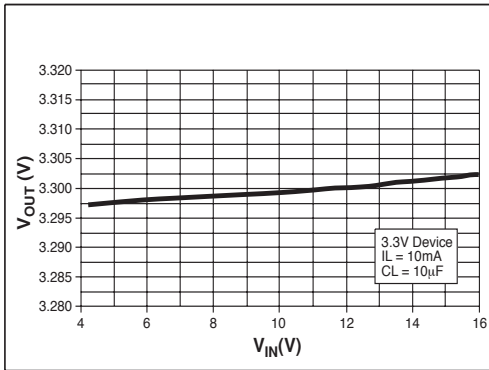

Figure 3. Line Regulation for 3.3V Device

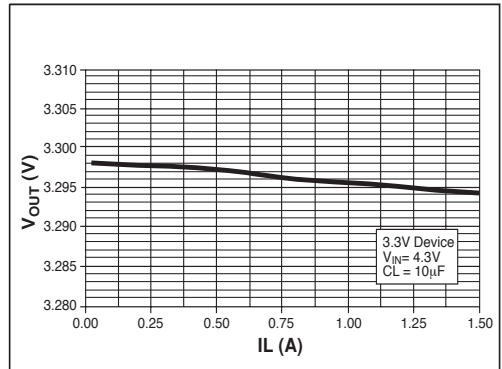

Figure 4. Load Regulation for 3.3V Device

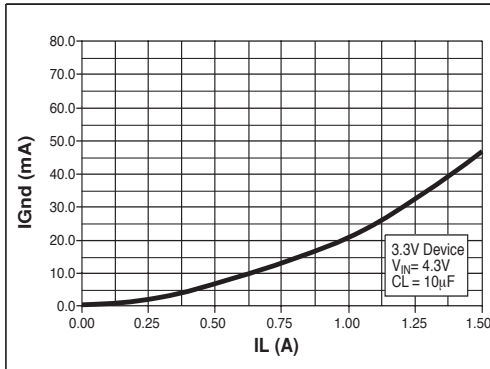

Figure 5. Ground Current vs Load Current for 3.3V Device

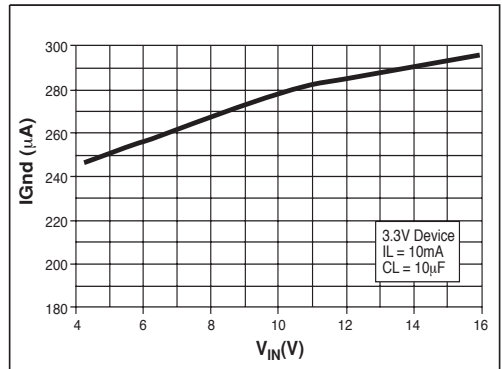

Figure 6. Ground Current vs Input Current

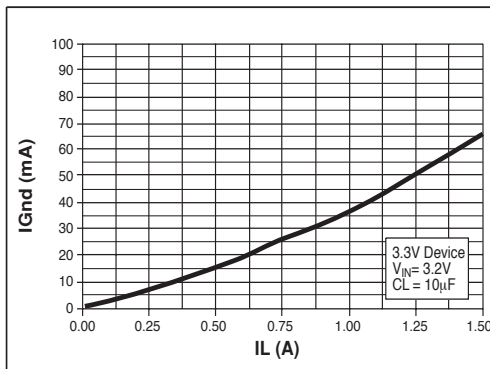

Figure 7. Ground Current vs Load Current in Dropout

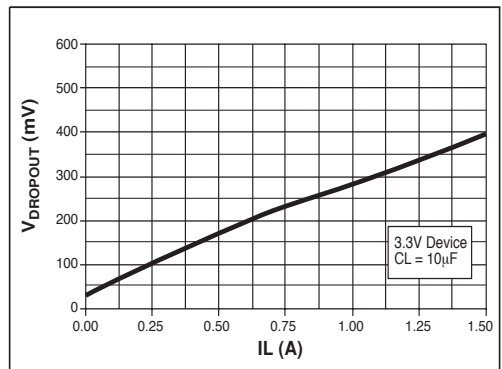

Figure 8. Dropout Voltage vs Load Current for 3.3V

TYPICAL PERFORMANCE CHARACTERISTICS

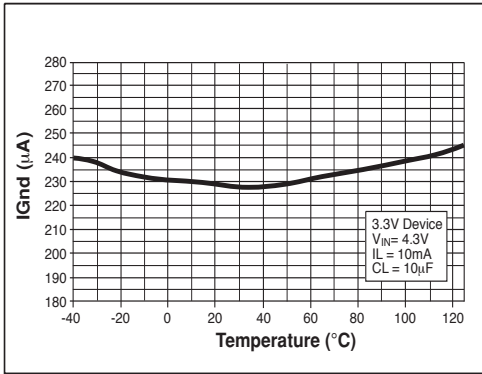

Figure 9. Ground Current vs Temperature at $I_{LOAD}=10mA$

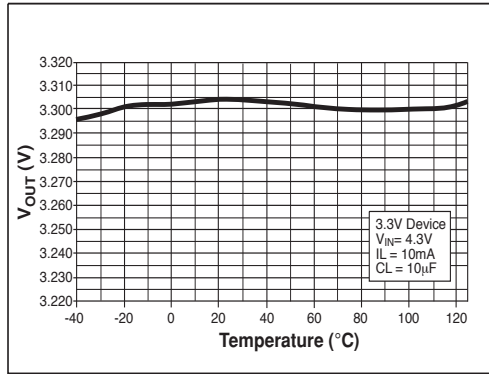

Figure 10. Output Voltage vs Temperature at $I_{LOAD}=10mA$

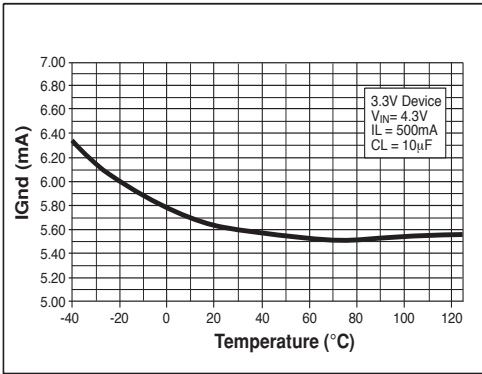

Figure 11. Ground Current vs Temperature at $I_{LOAD}=500mA$

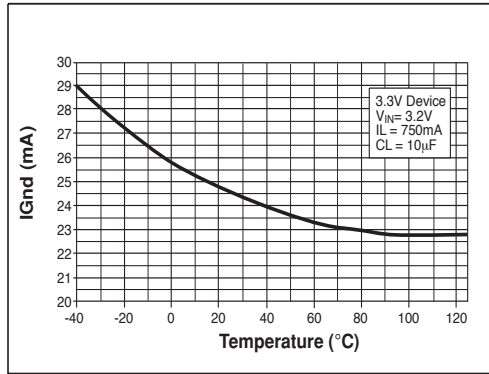

Figure 12. Ground Current vs Temperature in Dropout at $I_{LOAD}=750mA$

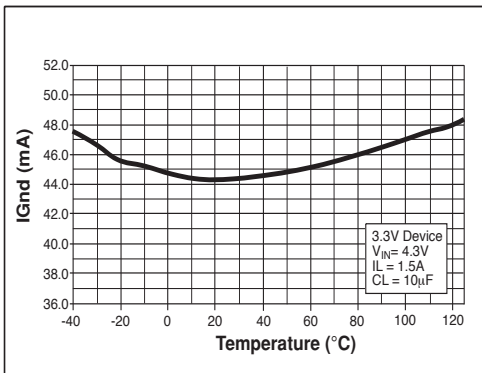

Figure 13. Ground Current vs Temperature at $I_{LOAD}=1.5A$

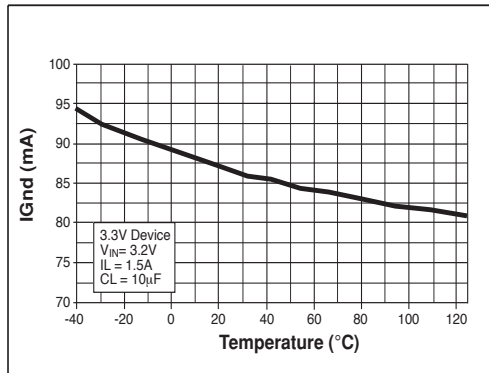

Figure 14. Ground Current vs Temperature in Dropout at $I_{LOAD}=1.5A$

TYPICAL PERFORMANCE CHARACTERISTICS

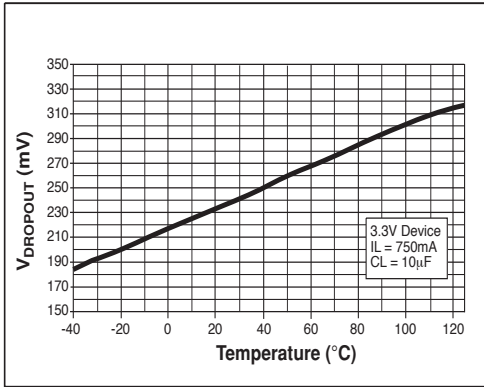

Figure 15. Dropout Voltage vs Temperature at $I_{LOAD}=750mA$

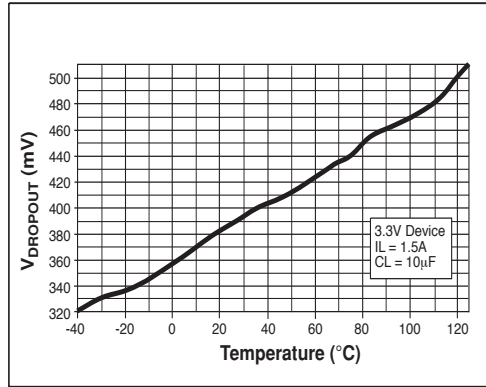

Figure 16. Dropout Voltage vs Temperature at $I_{LOAD}=1.5A$

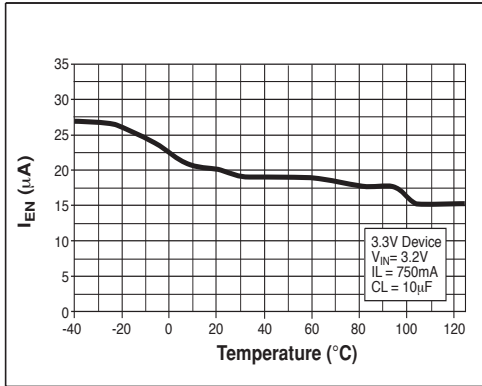

Figure 17. Enable Current vs Temperature for 3.3V Devices

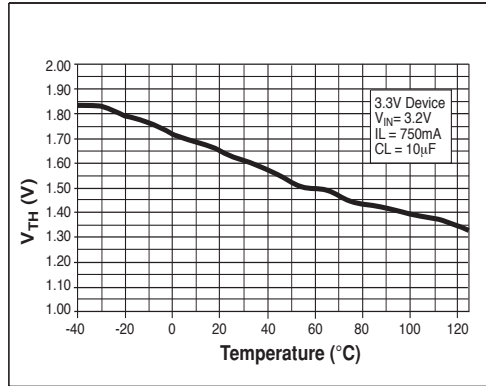

Figure 18. Enable Threshold vs Temperature for 3.3V Devices

The SPX2941 incorporates protection against over-current faults, reversed load insertion, over temperature operation, and positive and negative transient voltage.

Thermal Considerations

Although the SPX2941 offers limiting circuitry for overload conditions, it is still necessary to insure that the maximum junction temperature is not exceeded in the application. Heat will flow through the lowest resistance path, the junction-to-case path. The tab of the device is electrically connected to GND. In order to insure the best thermal flow of the component, proper mounting is required. Consult heatsink manufacturer for thermal resistance and design of heatsink.

Power dissipation is calculated as follows:

$$PD = (V_{IN} - V_{OUT}) \cdot (I_{OUT})$$

Maximum Junction Temperature range:

$$T_J = T_{A(MAX)} + PD \cdot \theta_{JA} \text{ (thermal resistance, junction-to-ambient)}$$

Maximum junction temperature must not exceed 125°C.

Capacitor Requirements

The output capacitor is needed to insure stability and minimize the output noise. The value of the capacitor varies with the load. However, a minimum value of 10 μ F

aluminum capacitor will guarantee stability over all load conditions. A tantalum capacitor is recommended if a faster load transient response is needed. If the power source has a high AC impedance, a 0.1 μ F ceramic capacitor between input & ground is recommended.

Minimum Load Current

To ensure a proper behavior of the regulator under light load, a minimum load of 5mA for SPX2941 is required.

Typical Application Circuit

Figure 19 shows a typical applications circuit for an adjustable output regulator. The values of R1 and R2 set the output voltage value as follows:

$$V_{OUT} = V_{REF} \cdot [1 + (R1/R2)].$$

A minimum value of 10k Ω is recommended for R2 with a range between 10k Ω to 47k Ω .

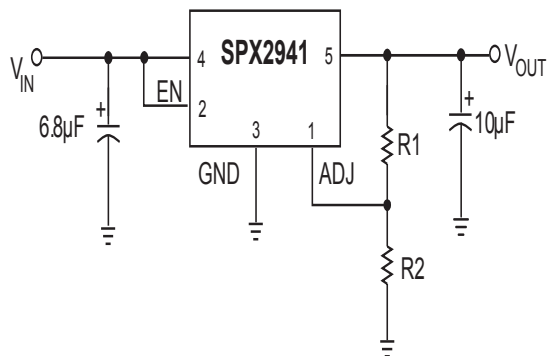
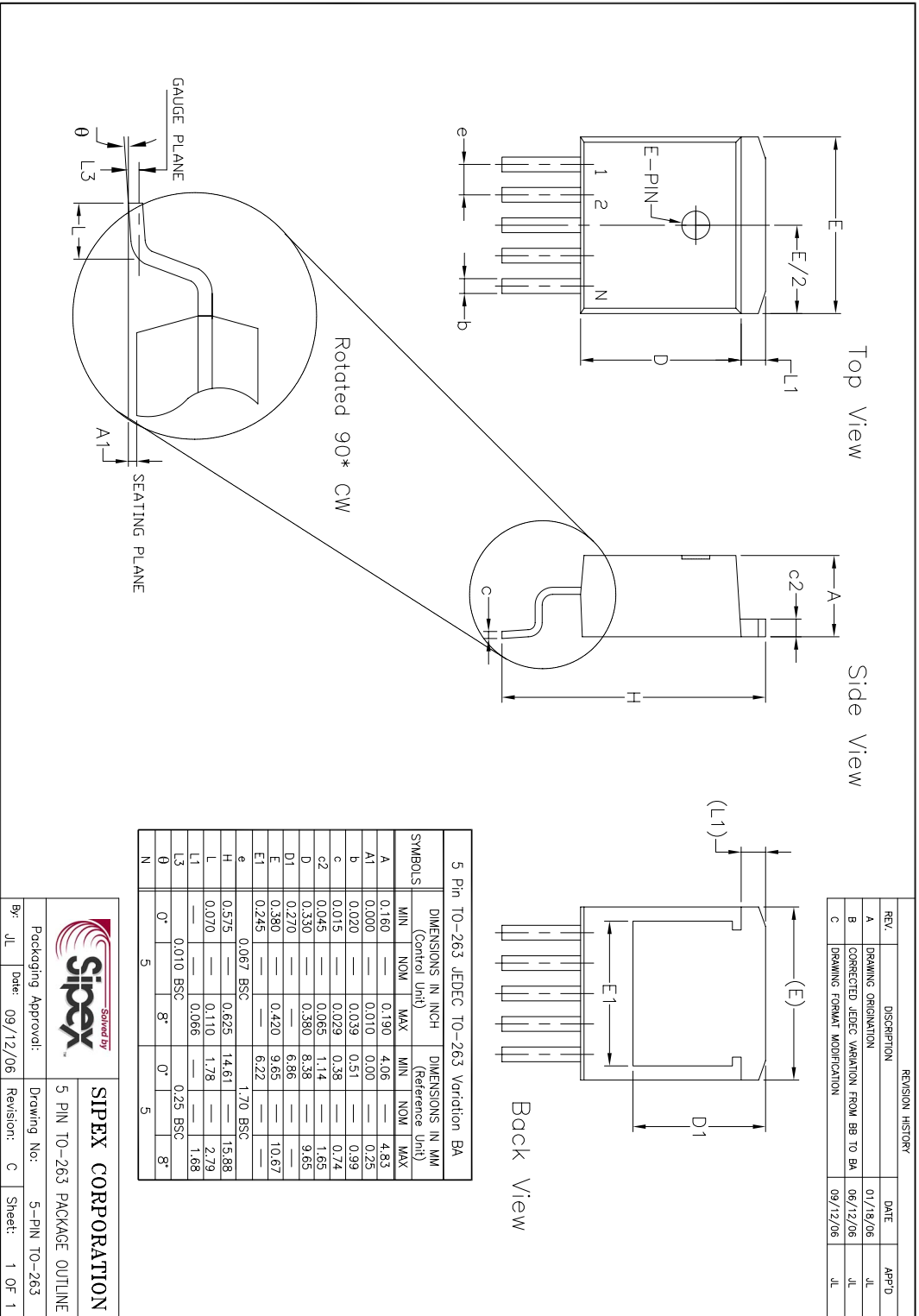
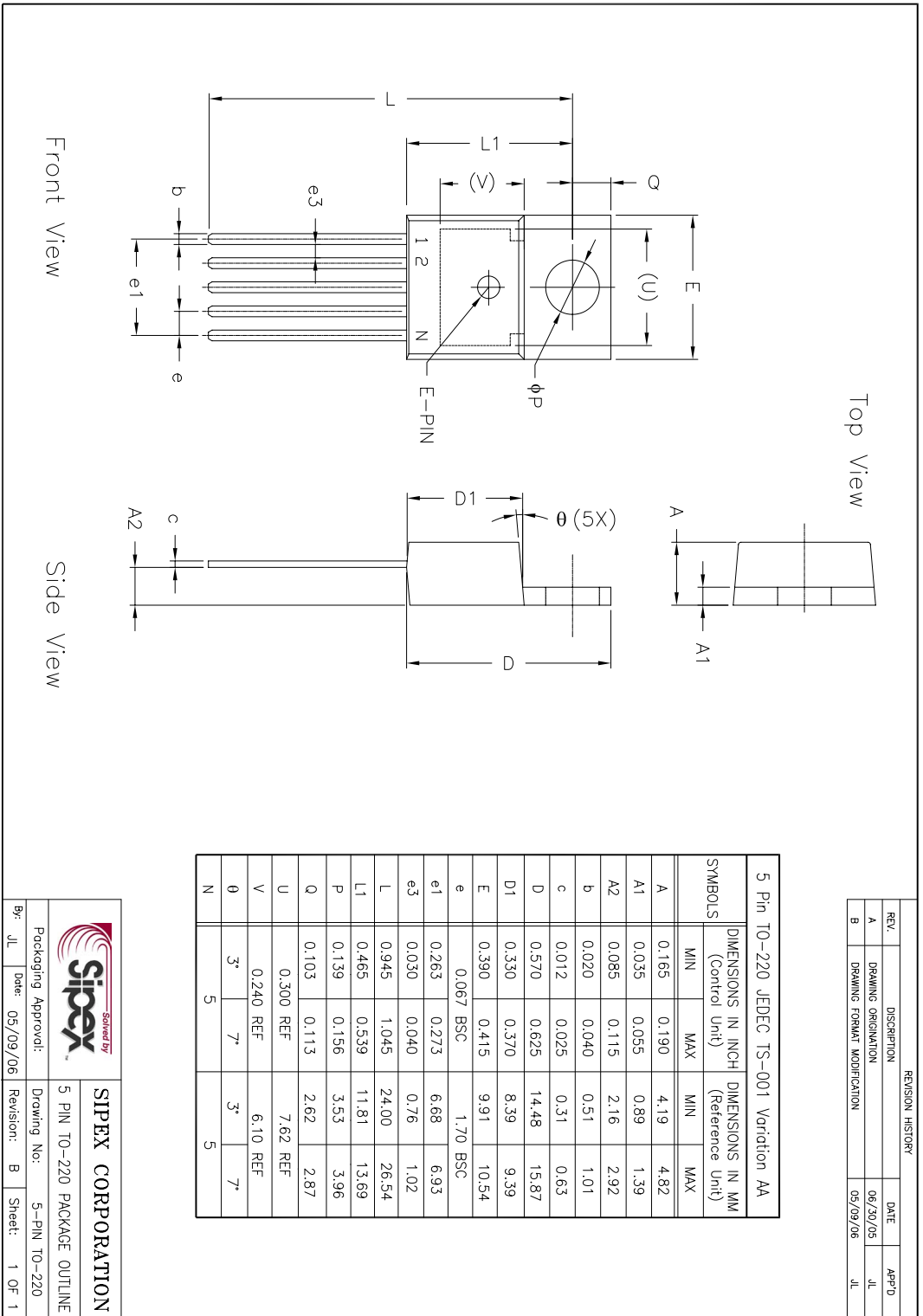



Figure 19. Adjustable Output Linear Regulator





REVISION HISTORY			
REV.	DESCRIPTION	DATE	APP'D
A	DRAWING ORIENTATION	06/20/05	JL
B	DRAWING FORMAT MODIFICATION	05/09/06	JL

		SIPLEX CORPORATION	
Packaging Approval:		Drawing No:	
By: JL	Date: 05/09/06	5 PIN TO-220 PACKAGE OUTLINE	5-PIN TO-220
Revision: B		Sheet: 1 OF 1	

ORDERING INFORMATION

PART NUMBER	ACCURACY ...	OUTPUT VOLTAGE	PACKAGE
SPX2941T5	3%	Adj.	5 lead TO-263
SPX2941T5/TR	3%	Adj.	5 lead TO-263
SPX2941U5	3%	Adj.	5 lead TO-220

Available in lead free packaging. To order add "-L" suffix to part number.

Example: SPX2941T5/TR = standard; SPX2941T5-L/TR = lead free

/TR = Tape and Reel

Pack quantity is 500 for TO-263-5.



Sipex Corporation

**Headquarters and
Sales Office**

233 South Hillview Drive
Milpitas, CA 95035
TEL: (408) 934-7500
FAX: (408) 935-7600

Sipex Corporation reserves the right to make changes to any products described herein. Sipex does not assume any liability arising out of the application or use of any product or circuit described herein; neither does it convey any license under its patent rights nor the rights of others.

AMEYA360

Components Supply Platform

Authorized Distribution Brand :



Website :

Welcome to visit www.ameya360.com

Contact Us :

➤ Address :

401 Building No.5, JiuGe Business Center, Lane 2301, Yishan Rd
Minhang District, Shanghai , China

➤ Sales :

Direct +86 (21) 6401-6692

Email amall@ameya360.com

QQ 800077892

Skype [ameyasales1](#) [ameyasales2](#)

➤ Customer Service :

Email service@ameya360.com

➤ Partnership :

Tel +86 (21) 64016692-8333

Email mkt@ameya360.com