

XPT IGBT Module

preliminary

$$V_{CES} = 1200V$$

$$I_{C25} = 220A$$

$$V_{CE(sat)} = 1.8V$$

Boost Chopper

Part number

MIXA150R1200VA

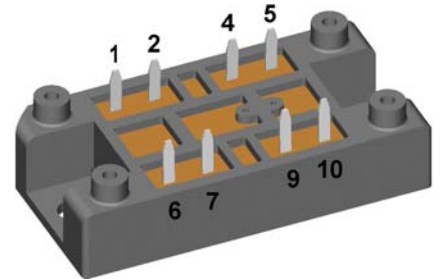

Backside: isolated

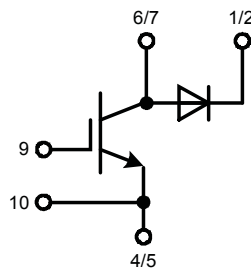

Features / Advantages:

- Easy paralleling due to the positive temperature coefficient of the on-state voltage
- Rugged XPT design (Xtreme light Punch Through) results in:
 - short circuit rated for 10 μ sec.
 - very low gate charge
 - low EMI
 - square RBSOA @ 3x I_c
- Thin wafer technology combined with the XPT design results in a competitive low $V_{CE(sat)}$
- SONIC™ diode
 - fast and soft reverse recovery
 - low operating forward voltage

Applications:

- AC motor drives
- Solar inverter
- Medical equipment
- Uninterruptible power supply
- Air-conditioning systems
- Welding equipment
- Switched-mode and resonant-mode power supplies
- Inductive heating, cookers
- Pumps, Fans

Package: V1-A-Pack

- Isolation Voltage: 3600 V~
- Industry standard outline
- RoHS compliant
- Soldering pins for PCB mounting
- Height: 17 mm
- Base plate: DCB ceramic
- Reduced weight
- Advanced power cycling

IGBT				Ratings			
Symbol	Definition	Conditions	min.	typ.	max.	Unit	
V_{CES}	collector emitter voltage	$T_{VJ} = 25^{\circ}C$			1200	V	
V_{GES}	max. DC gate voltage				± 20	V	
V_{GEM}	max. transient gate emitter voltage				± 30	V	
I_{C25}	collector current	$T_C = 25^{\circ}C$			220	A	
I_{C80}		$T_C = 80^{\circ}C$			150	A	
P_{tot}	total power dissipation	$T_C = 25^{\circ}C$			695	W	
$V_{CE(sat)}$	collector emitter saturation voltage	$I_C = 150A; V_{GE} = 15V$		1.8	2.1	V	
				2.1		V	
$V_{GE(th)}$	gate emitter threshold voltage	$I_C = 6mA; V_{CE} = V_{CE}$	5.4	5.9	6.5	V	
I_{CES}	collector emitter leakage current	$V_{CE} = V_{CES}; V_{GE} = 0V$			0.5	mA	
				1		mA	
I_{GES}	gate emitter leakage current	$V_{GE} = \pm 20V$			500	nA	
$Q_{G(on)}$	total gate charge	$V_{CE} = 600V; V_{GE} = 15V; I_C = 150A$		470		nC	
$t_{d(on)}$	turn-on delay time	inductive load $V_{CE} = 600V; I_C = 150A$ $V_{GE} = \pm 15V; R_G = 4.7\Omega$		70		ns	
t_r	current rise time		$T_{VJ} = 125^{\circ}C$		40		ns
$t_{d(off)}$	turn-off delay time				250		ns
t_f	current fall time				100		ns
E_{on}	turn-on energy per pulse				14		mJ
E_{off}	turn-off energy per pulse				16		mJ
RBSOA	reverse bias safe operating area	$V_{GE} = \pm 15V; R_G = 4.7\Omega$					
I_{CM}		$V_{CEmax} = 1200V$			450	A	
SCSOA	short circuit safe operating area	$V_{CEmax} = 1200V$					
t_{sc}	short circuit duration	$V_{CE} = 900V; V_{GE} = \pm 15V$			10	μs	
I_{sc}	short circuit current	$R_G = 4.7\Omega; \text{non-repetitive}$		600		A	
R_{thJC}	thermal resistance junction to case				0.18	K/W	
R_{thCH}	thermal resistance case to heatsink			0.20		K/W	
Diode							
V_{RRM}	max. repetitive reverse voltage	$T_{VJ} = 25^{\circ}C$			1200	V	
I_{F25}	forward current	$T_C = 25^{\circ}C$			190	A	
I_{F80}		$T_C = 80^{\circ}C$			130	A	
V_F	forward voltage	$I_F = 150A$			2.20	V	
				1.95		V	
I_R	reverse current	$V_R = V_{RRM}$			0.3	mA	
				0.8		mA	
Q_{rr}	reverse recovery charge	$V_R = 600V$ $-di_F/dt = 2500A/\mu s$ $I_F = 150A; V_{GE} = 0V$		20		μC	
I_{RM}	max. reverse recovery current		$T_{VJ} = 125^{\circ}C$		175		A
t_{rr}	reverse recovery time				350		ns
E_{rec}	reverse recovery energy				10		mJ
R_{thJC}	thermal resistance junction to case				0.28	K/W	
R_{thCH}	thermal resistance case to heatsink			0.20		K/W	

preliminary

Package V1-A-Pack		Ratings				
Symbol	Definition	Conditions	min.	typ.	max.	Unit
I_{RMS}	RMS current	per terminal			100	A
T_{stg}	storage temperature		-40		125	°C
T_{VJ}	virtual junction temperature		-40		150	°C
Weight				37		g
M_D	mounting torque		2		2.5	Nm
$d_{Spp/App}$	creepage distance on surface striking distance through air	terminal to terminal	6.0			mm
$d_{Spb/Apb}$		terminal to backside	12.0			mm
V_{ISOL}	isolation voltage	t = 1 second	3600			V
		t = 1 minute	3000			V

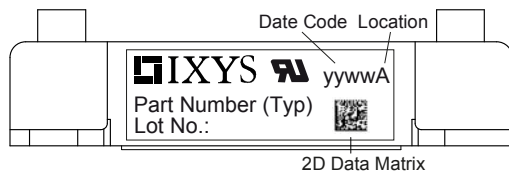

Part number

- M = Module
- I = IGBT
- X = XPT IGBT
- A = Gen 1 / std
- 150 = Current Rating [A]
- R = Boost Chopper
- 1200 = Reverse Voltage [V]
- VA = V1-A-Pack

Ordering	Part Number	Marking on Product	Delivery Mode	Quantity	Code No.
Standard	MIXA150R1200VA	MIXA150R1200VA	Box	10	511595

Equivalent Circuits for Simulation

* on die level

$T_{VJ} = 150^\circ\text{C}$

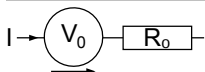

$V_{0\max}$ threshold voltage
 $R_{0\max}$ slope resistance *

	IGBT	Diode	
$V_{0\max}$	1.1	1.25	V
$R_{0\max}$	9.2	5.7	mΩ

Outlines V1-A-Pack

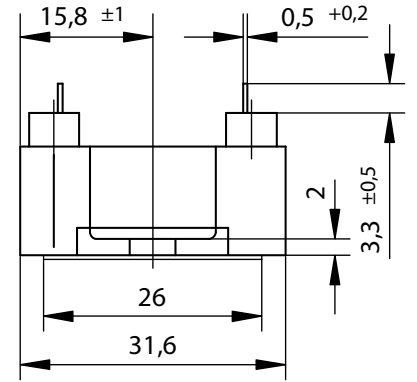
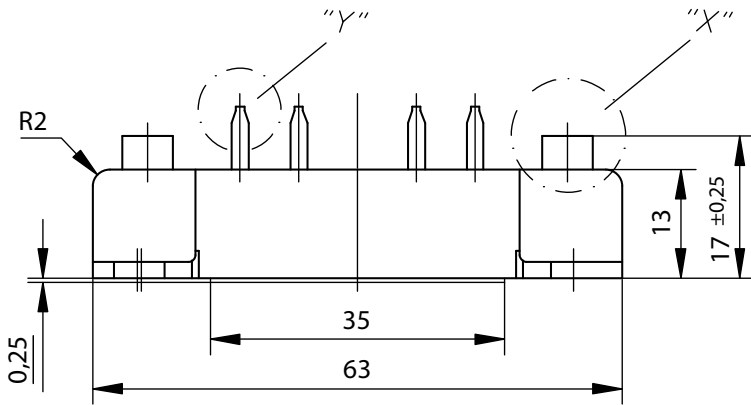

Detail "X" M 2:1

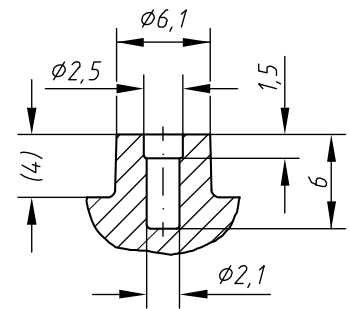
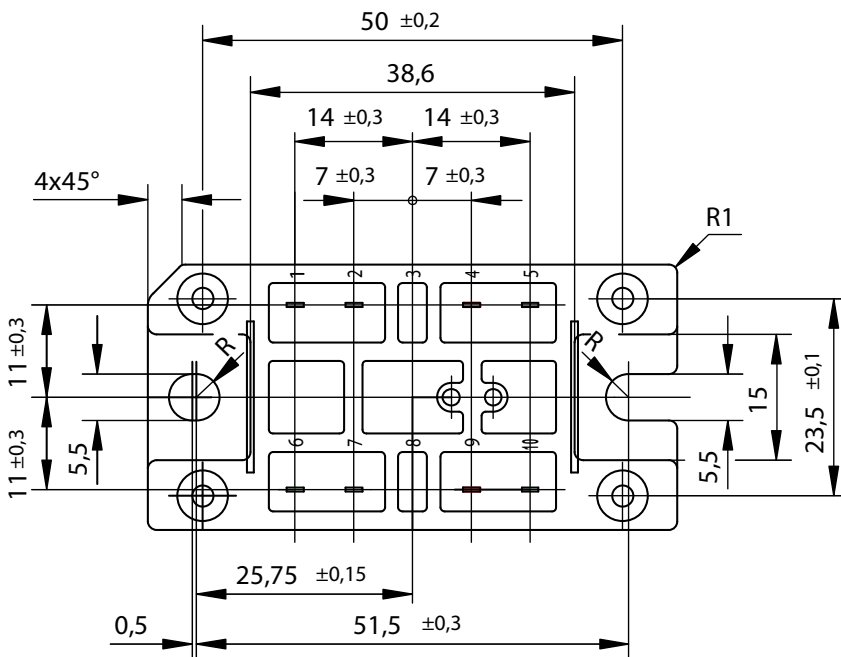

Detail "Y" M 5:1

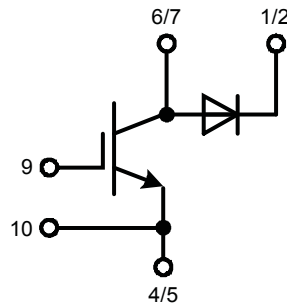
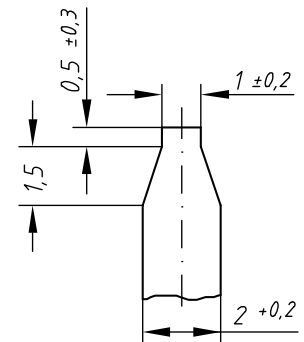

IGBT

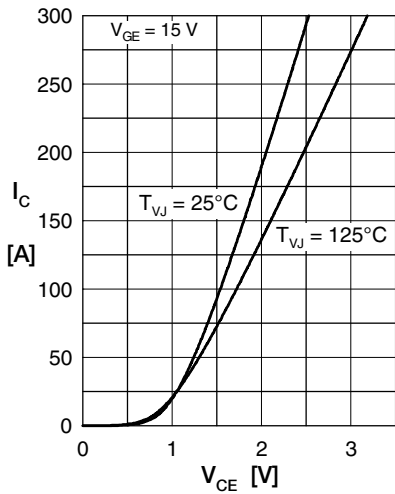

Fig. 1 Typ. output characteristics

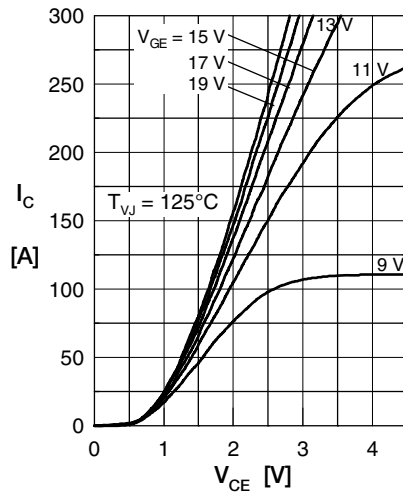

Fig. 2 Typ. output characteristics

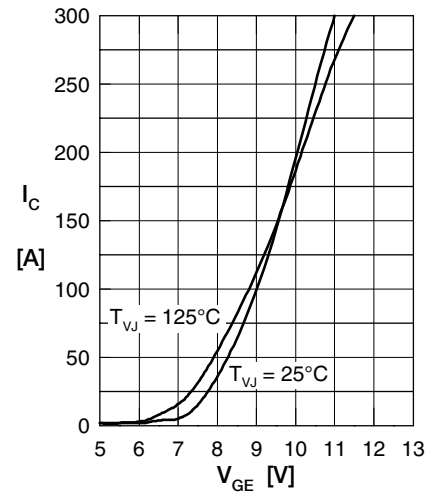

Fig. 3 Typ. transfer characteristics

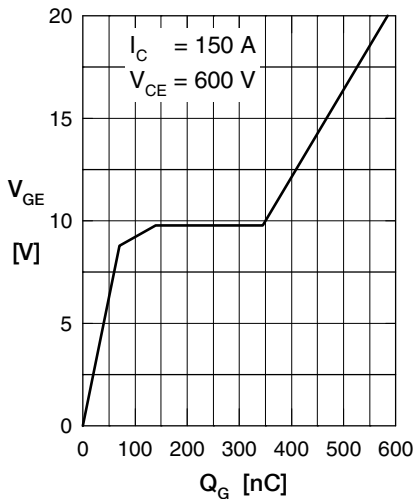

Fig. 4 Typ. turn-on gate charge

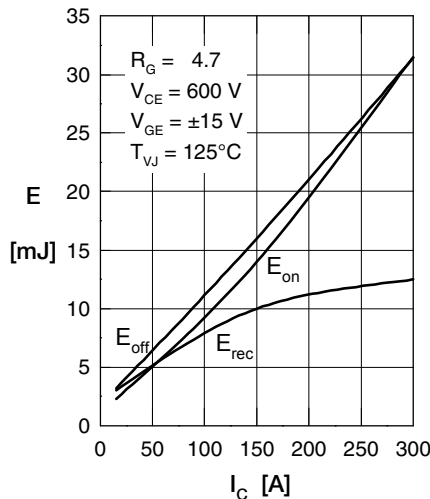

Fig. 5 Typ. switching energy versus collector current

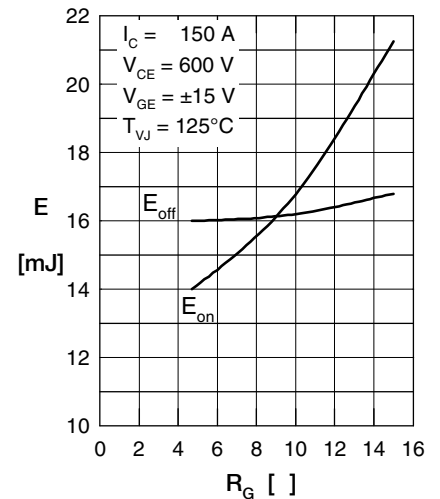

Fig. 6 Typ. switching energy versus gate resistance

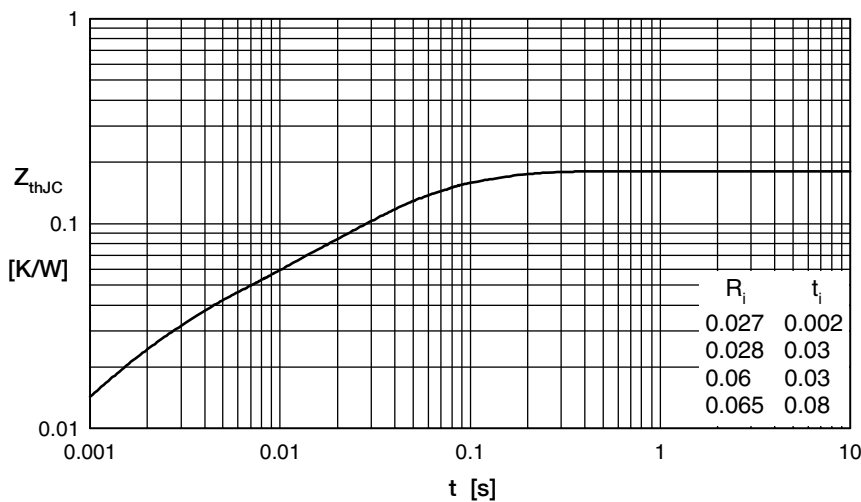

Fig. 7 Typ. transient thermal impedance

Diode

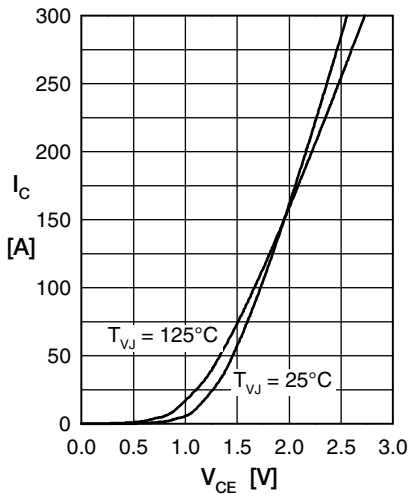

Fig. 1 Typ. Forward current versus V_F

Fig. 2 Typ. reverse recovery charge Q_{rr} versus di/dt

Fig. 3 Typ. peak reverse current I_{RM} versus di/dt

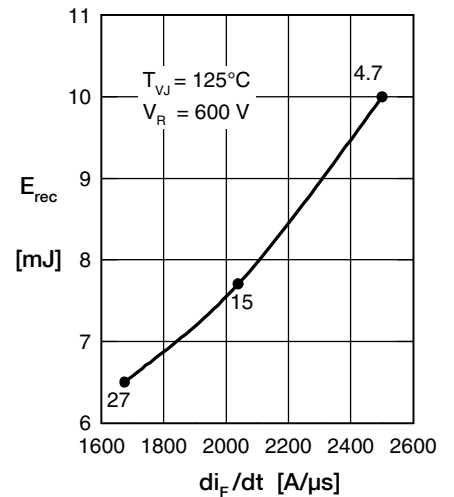

Fig. 4 Dynamic parameters Q_{rr} , I_{RM} versus T_{VJ}

Fig. 5 Typ. recovery time t_{rr} versus $-di_F/dt$

Fig. 6 Typ. recovery energy E_{rec} versus $-di/dt$

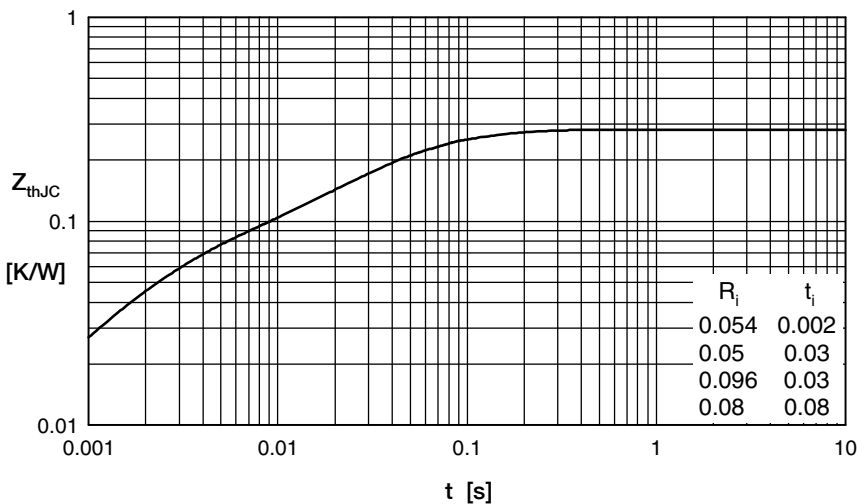

Fig. 7 Transient thermal impedance junction to case

AMEYA360

Components Supply Platform

Authorized Distribution Brand :



Website :

Welcome to visit www.ameya360.com

Contact Us :

➤ Address :

401 Building No.5, JiuGe Business Center, Lane 2301, Yishan Rd
Minhang District, Shanghai , China

➤ Sales :

Direct +86 (21) 6401-6692

Email amall@ameya360.com

QQ 800077892

Skype [ameyasales1](#) [ameyasales2](#)

➤ Customer Service :

Email service@ameya360.com

➤ Partnership :

Tel +86 (21) 64016692-8333

Email mkt@ameya360.com