

## Single-line low capacitance Transil™, transient surge voltage suppressor (TVS) for ESD protection

Datasheet – production data

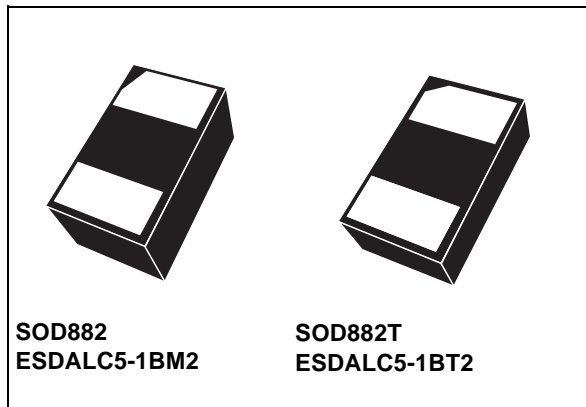

### Features

- Single-line low capacitance Transil diode
- Bidirectional ESD protection
- Breakdown voltage  $V_{BR} = 5.8 \text{ V min.}$
- Low diode capacitance (26 pF typ at 0 V)
- Low leakage current < 60 nA at 5 V
- Very small PCB area: 0.6 mm<sup>2</sup>

### Benefits

- High ESD protection level
- High integration
- Suitable for high density boards
- Lead-free packages
- ECOPACK®2 compliant components

### Complies with the following standards:

- IEC 61000-4-2 (exceeds level 4)
  - 30 kV (air discharge)
  - 30 kV (contact discharge)
- MIL STD 883G - Method 3015-7: class 3
  - Human body model

### Applications

Where transient overvoltage protection in ESD sensitive equipment is required, such as:

- Computers
- Printers
- Communication systems
- Cellular phone handsets and accessories
- Video equipment

### Description

The ESDALC5-1BM2 and ESDALC5-1BT2 are bidirectional single-line TVS diodes designed to protect data lines or other I/O ports against ESD transients.

These devices are ideal for applications where both reduced line capacitance and board space saving are required.

Figure 1. Functional diagram

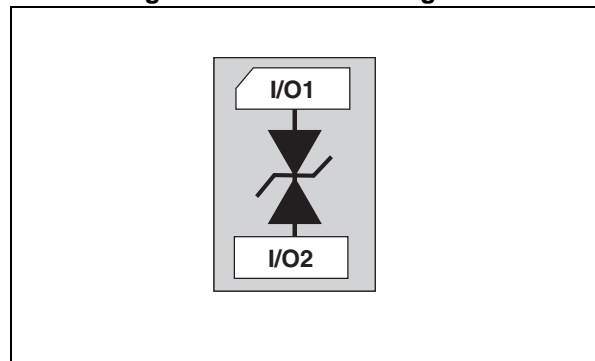

TM: Transil is a trademark of STMicroelectronics

# 1 Characteristics

**Table 1. Absolute maximum ratings ( $T_{amb} = 25\text{ °C}$ )**

Symbol	Parameter		Value	Unit
$V_{PP}$	Peak pulse voltage	IEC 61000-4-2 contact discharge	30	kV
		IEC 61000-4-2 air discharge	30	
$P_{PP}$	Peak pulse power dissipation (8/20 $\mu$ s)	$T_j$ initial = $T_{amb}$	150	W
$I_{PP}$	Peak pulse current (8/20 $\mu$ s)		9	A
$T_j$	Operating junction temperature range		-55 to +150	$^{\circ}$ C
$T_{stg}$	Storage temperature range		-65 to +150	$^{\circ}$ C
$T_L$	Maximum lead temperature for soldering during 10 s		260	$^{\circ}$ C

**Figure 2. Electrical characteristics (definitions)**

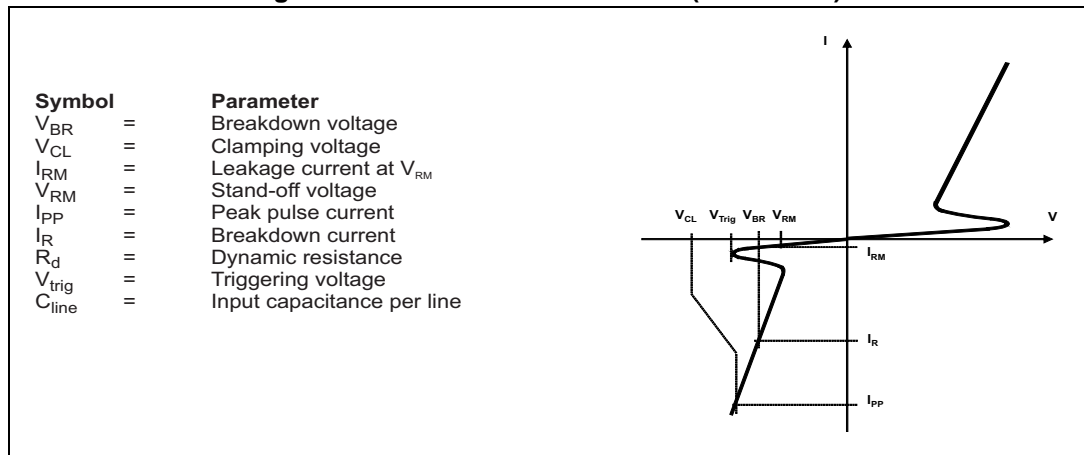

**Table 2. Electrical characteristics (values,  $T_{amb} = 25\text{ °C}$ )**

Symbol	Test condition	Min.	Typ.	Max.	Unit
$V_{BR}$	From I/O1 to I/O2, $I_R = 1\text{ mA}$	11	13	17	V
	From I/O2 to I/O1, $I_R = 1\text{ mA}$	5.8	8	11	
$I_{RM}$	$V_{RM} = 5\text{ V}$			60	nA
$R_d$	Dynamic resistance, pulse width 100 ns				$\Omega$
	From I/O1 to I/O2		0.25		
	From I/O2 to I/O1		0.23		
$C_{line}$	$F = 1\text{ MHz}$ , $V_R = 0\text{ V}$		26	30	pF
$V_{CL}$	8 kV contact discharge after 30 ns IEC 61000 4-2				V
	From I/O1 to I/O2		17.5		
	From I/O2 to I/O1		12.5		

Figure 3. Peak pulse power dissipation versus initial junction temperature (maximum values)

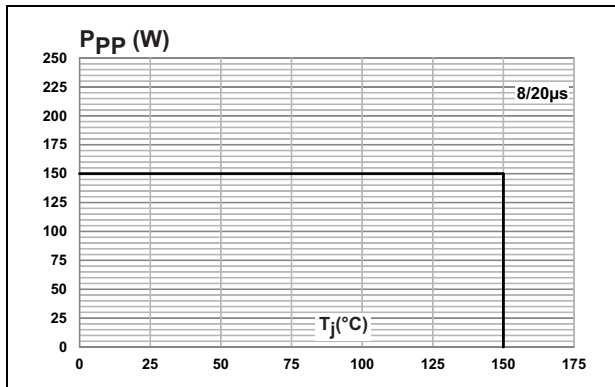

Figure 4. Leakage current versus junction temperature (typical values)

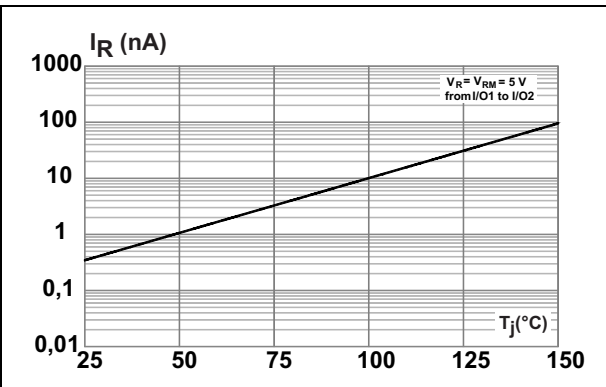

Figure 5. Leakage current versus junction temperature (typical values)

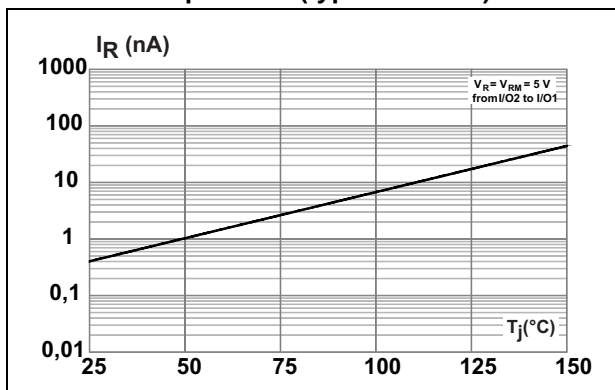

Figure 6. Peak pulse power versus exponential pulse duration (maximum values)

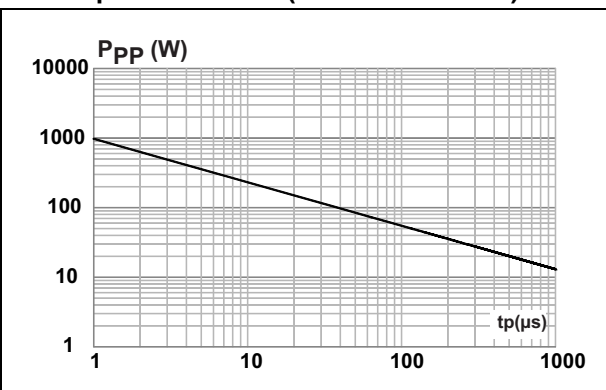

Figure 7. Clamping voltage versus peak pulse current (typical values)

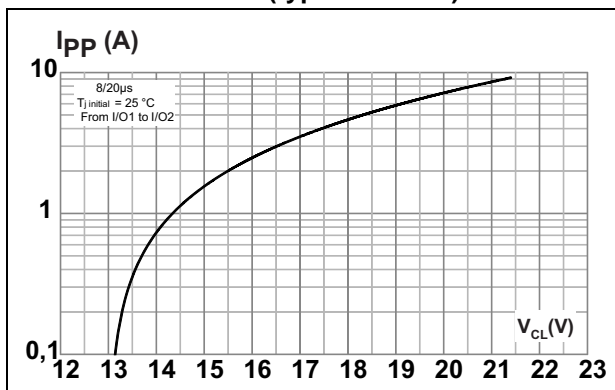

Figure 8. Clamping voltage versus peak pulse current (typical values)

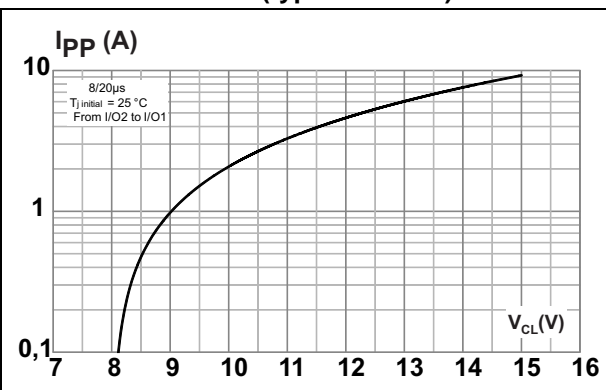

Figure 9. Junction capacitance versus reverse applied voltage (typical values from I/O1 to I/O2)



Figure 11. ESD response to IEC 61000-4-2 (+8 kV air discharge)

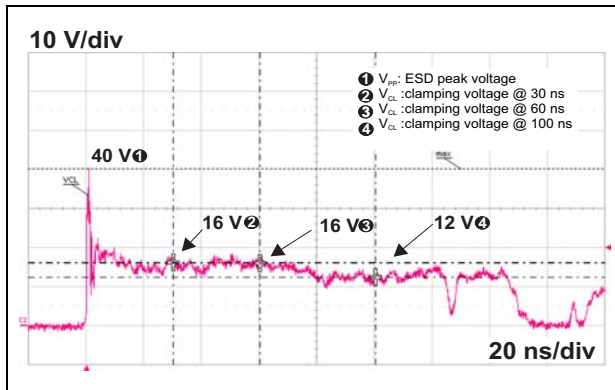

Figure 13. S21 attenuation measurement result

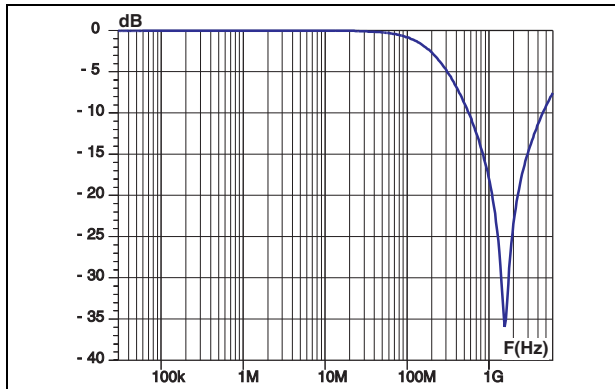

Figure 10. Junction capacitance versus reverse applied voltage (typical values from I/O2 to I/O1)

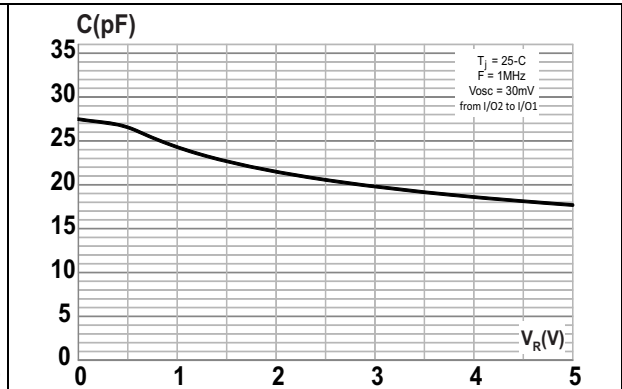

Figure 12. ESD response to IEC 61000-4-2 (-8 kV air discharge)

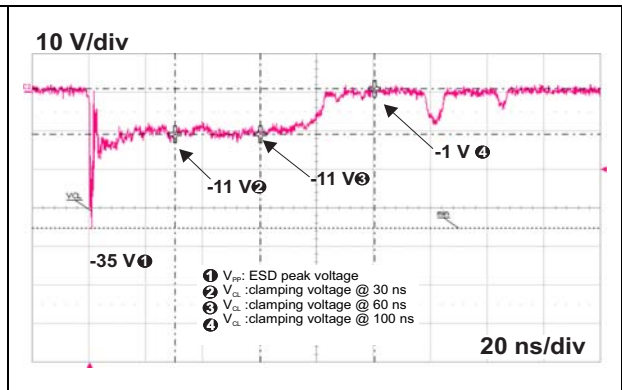
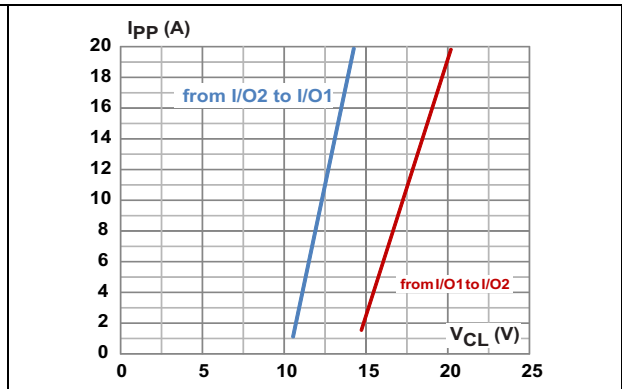

Figure 14. TLP measurement



## 2 Package information

- Epoxy meets UL94, V0
- Lead-free packages

In order to meet environmental requirements, ST offers these devices in different grades of ECOPACK® packages, depending on their level of environmental compliance. ECOPACK® specifications, grade definitions and product status are available at: [www.st.com](http://www.st.com). ECOPACK® is an ST trademark.

Figure 15. SOD882 dimension definitions

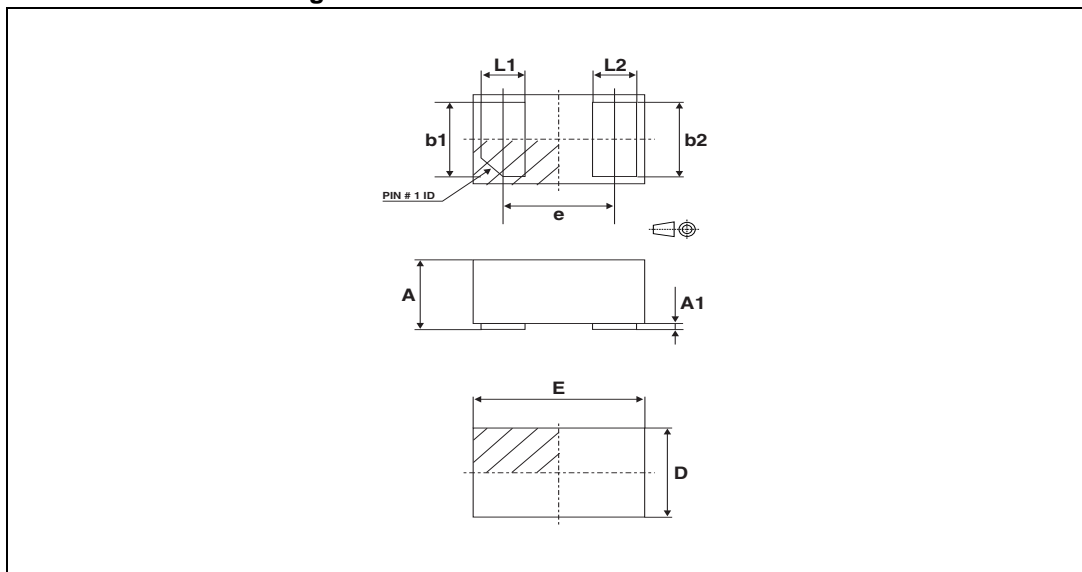

Table 3. SOD882 dimension values

Ref.	Dimensions					
	Millimeters			Inches		
	Min.	Typ.	Max.	Min.	Typ.	Max.
A	0.40	0.47	0.50	0.016	0.019	0.020
A1	0.00		0.05	0.000		0.002
b1	0.45	0.50	0.55	0.018	0.020	0.022
b2	0.45	0.50	0.55	0.018	0.020	0.022
D	0.55	0.60	0.65	0.022	0.024	0.026
E	0.95	1.00	1.05	0.037	0.039	0.041
e	0.60	0.65	0.70	0.024	0.026	0.028
L1	0.20	0.25	0.30	0.008	0.010	0.012
L2	0.20	0.25	0.30	0.008	0.010	0.012

Figure 16. SOD882 footprint in mm (inches)

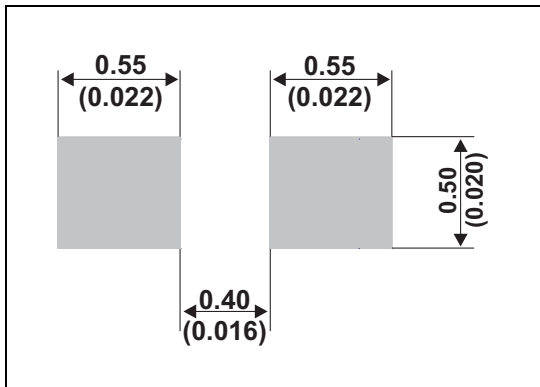
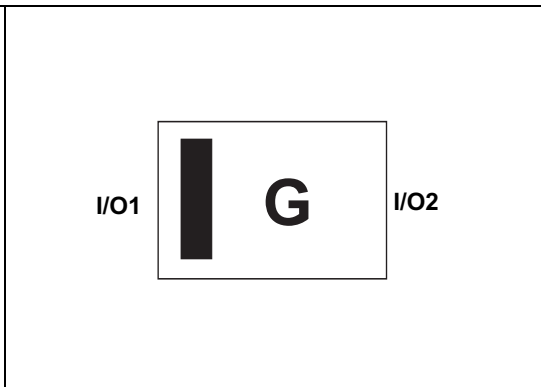

Figure 17. SOD882 marking



Note: Product marking may be rotated by multiples of 90° for assembly plant differentiation. In no case should this product marking be used to orient the component for its placement on a PCB. Only I/O1 mark is to be used for this purpose.

Figure 18. SOD882 tape and reel specifications

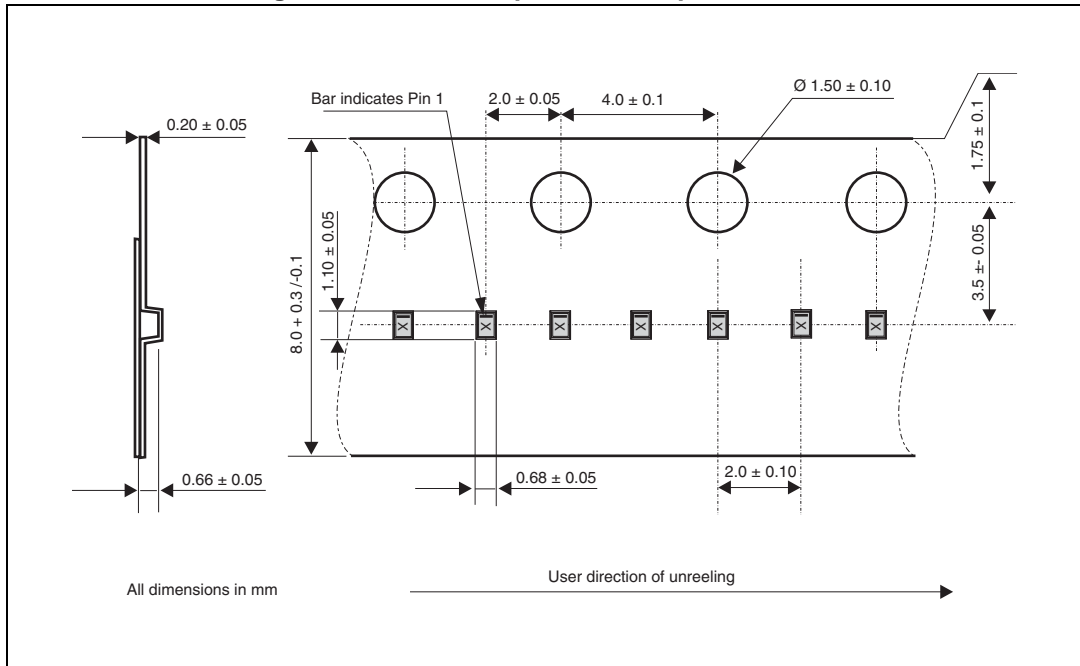

Figure 19. SOD882T dimension definitions

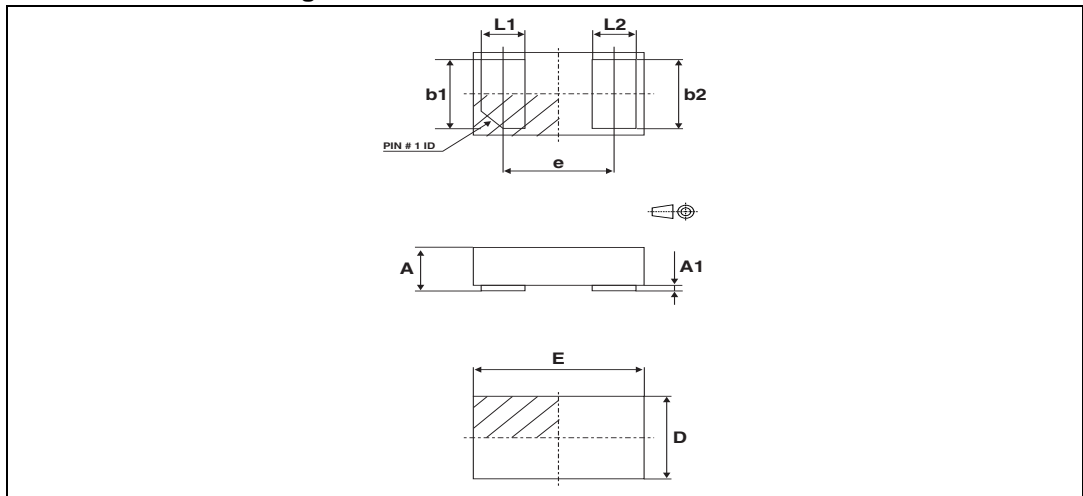

Table 4. SOD882T dimension values

Ref.	Dimensions					
	Millimeters			Inches		
	Min.	Typ.	Max.	Min.	Typ.	Max.
A	0.30		0.40	0.012		0.016
A1	0.00		0.05	0.000		0.002
b1	0.45	0.50	0.55	0.018	0.020	0.022
b2	0.45	0.50	0.55	0.018	0.020	0.022
D	0.55	0.60	0.65	0.022	0.024	0.026
E	0.95	1.00	1.05	0.037	0.039	0.041
e	0.60	0.65	0.70	0.024	0.026	0.028
L1	0.20	0.25	0.30	0.008	0.010	0.012
L2	0.20	0.25	0.30	0.008	0.010	0.012

Figure 20. SOD882T footprint in mm (inches)

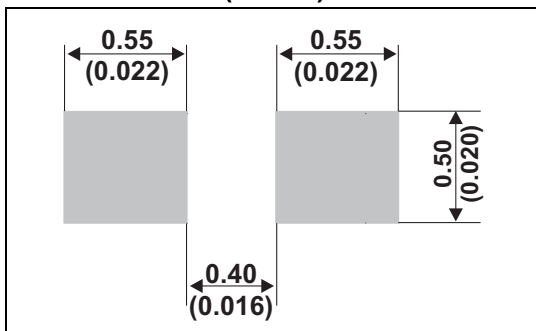
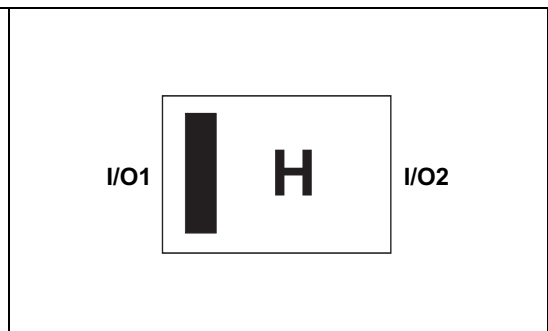
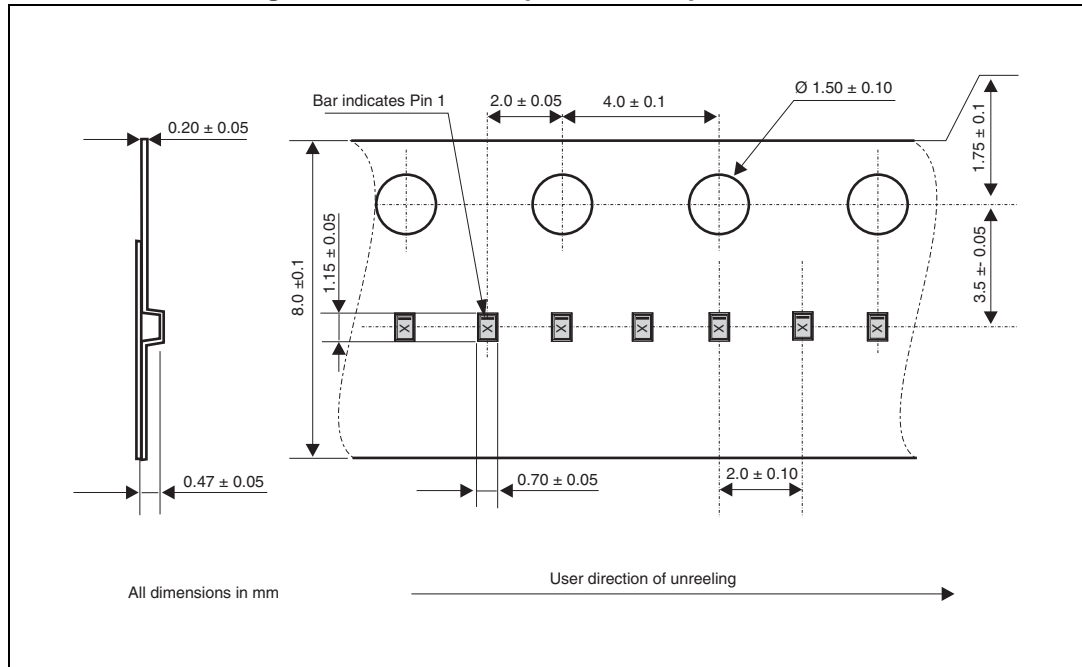

Figure 21. SOD882T marking



Note: Product marking may be rotated by multiples of 90° for assembly plant differentiation. In no case should this product marking be used to orient the component for its placement on a PCB. Only I/O1 mark is to be used for this purpose.

Figure 22. SOD882T tape and reel specifications



### 3 Recommendation on PCB assembly

#### 3.1 Stencil opening design

1. General recommendation on stencil opening design
  - a) Stencil opening dimensions: L (Length), W (Width), T (Thickness).

**Figure 23. Stencil opening dimensions**

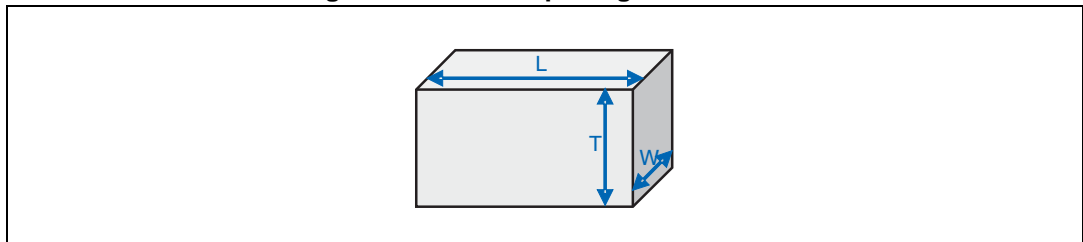

- b) General design rule
  - Stencil thickness (T) = 75 ~ 125 μm
  - Aspect Ratio =  $\frac{W}{T} \geq 1,5$
  - Aspect Area =  $\frac{L \times W}{2T(L + W)} \geq 0,66$

2. Reference design
  - a) Stencil opening thickness: 100 μm
  - b) Stencil opening for central exposed pad: Opening to footprint ratio is 50%.
  - c) Stencil opening for leads: Opening to footprint ratio is 90%.

**Figure 24. Recommended stencil window position in mm (inches)**

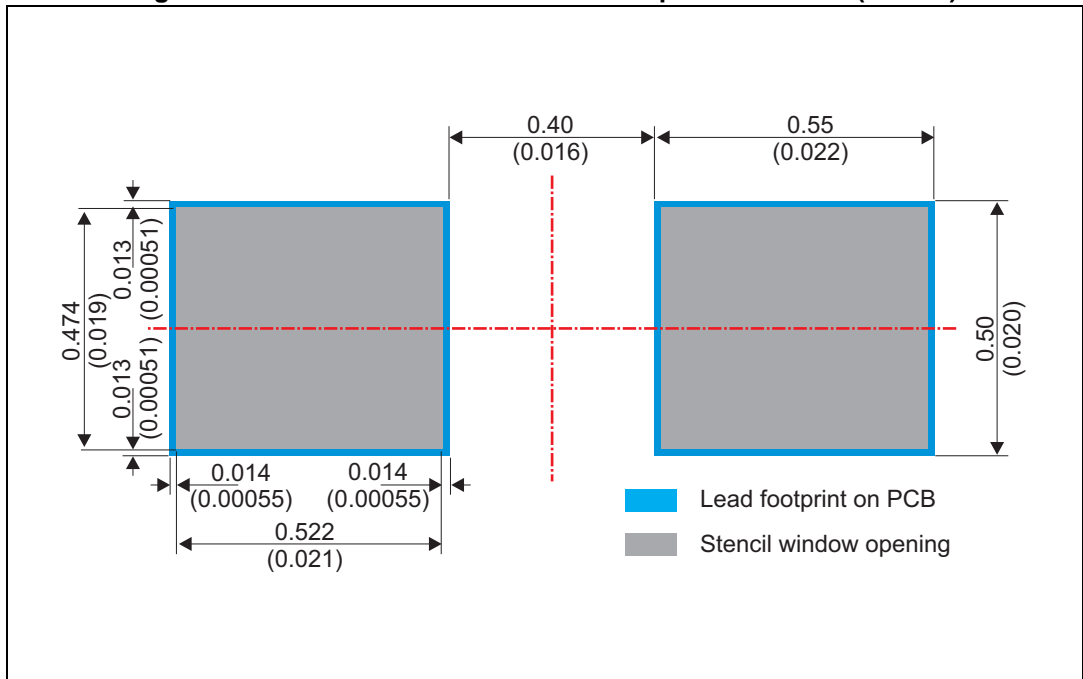

### 3.2 Solder paste

1. Halide-free flux qualification ROL0 according to ANSI/J-STD-004.
2. “No clean” solder paste is recommended.
3. Offers a high tack force to resist component movement during high speed.
4. Solder paste with fine particles: powder particle size is 20-45  $\mu\text{m}$ .

### 3.3 Placement

1. Manual positioning is not recommended.
2. It is recommended to use the lead recognition capabilities of the placement system, not the outline centering.
3. Standard tolerance of  $\pm 0.05$  mm is recommended.
4. 3.5 N placement force is recommended. Too much placement force can lead to squeezed out solder paste and cause solder joints to short. Too low placement force can lead to insufficient contact between package and solder paste that could cause open solder joints or badly centered packages.
5. To improve the package placement accuracy, a bottom side optical control should be performed with a high resolution tool.
6. For assembly, a perfect supporting of the PCB (all the more on flexible PCB) is recommended during solder paste printing, pick and place and reflow soldering by using optimized tools.

### 3.4 PCB design preference

1. To control the solder paste amount, the closed via is recommended instead of open vias.
2. The position of tracks and open vias in the solder area should be well balanced. The symmetrical layout is recommended, in case any tilt phenomena caused by asymmetrical solder paste amount due to the solder flow away.

### 3.5 Reflow profile

Figure 25. ST ECOPACK<sup>®</sup> recommended soldering reflow profile for PCB mounting

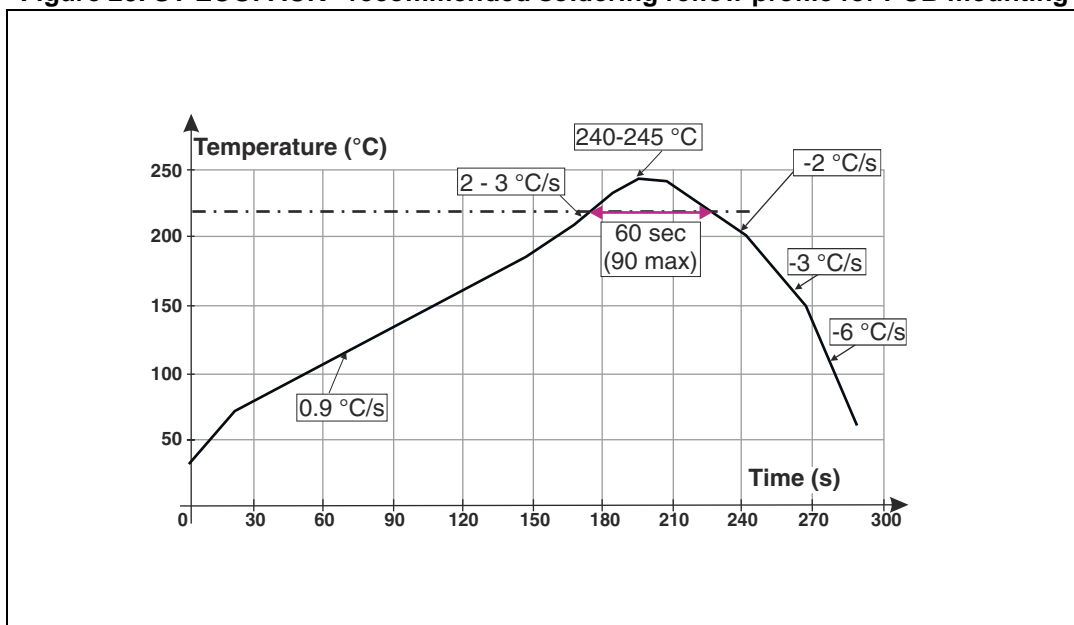

Note: Minimize air convection currents in the reflow oven to avoid component movement.

## 4 Ordering information

Figure 26. Ordering information scheme

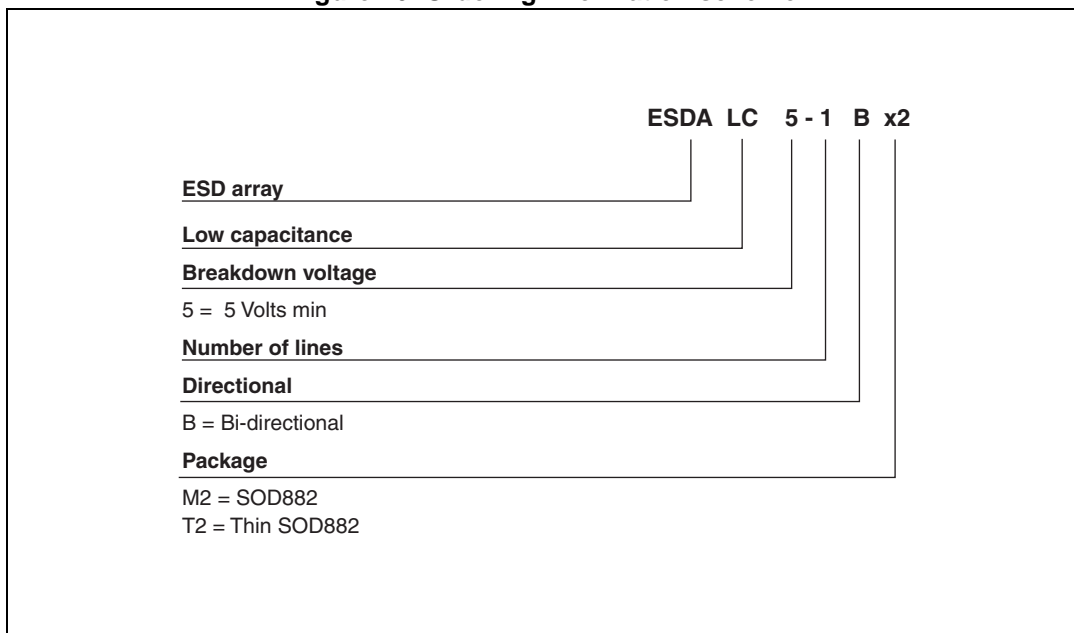

Table 5. Ordering information

Order code	Marking <sup>(1)</sup>	Package	Weight	Base qty	Delivery mode
ESDALC5-1BM2	G	SOD882	0.93 mg	12000	Tape and reel
ESDALC5-1BT2	H	SOD882T	0.82 mg	12000	Tape and reel

1. The marking can be rotated by multiples of 90° to differentiate assembly location

## 5 Revision history

Table 6. Document revision history

Date	Revision	Changes
02-Feb-2010	1	Initial release.
06-Jun-2012	2	Updated <a href="#">Figure 11</a> , <a href="#">Figure 12</a> , <a href="#">Figure 15</a> , <a href="#">Figure 19</a> , <a href="#">Table 3</a> , and <a href="#">Table 4</a> . Updated note in page 7, 8 and 13. Updated I <sub>RM</sub> in <a href="#">Table 2</a> .
05-Mar-2013	3	Clamping voltage at 30 ns added in <a href="#">Table 2</a> .
09-Jan-2014	4	Updated <a href="#">Table 1</a> , <a href="#">Table 2</a> , <a href="#">Table 5</a> , <a href="#">Figure 2</a> , <a href="#">Figure 3</a> , <a href="#">Figure 4</a> , <a href="#">Figure 5</a> , <a href="#">Figure 6</a> , <a href="#">Figure 7</a> , <a href="#">Figure 8</a> , <a href="#">Figure 9</a> , <a href="#">Figure 10</a> , <a href="#">Figure 11</a> , <a href="#">Figure 12</a> , <a href="#">Figure 16</a> , <a href="#">Figure 17</a> , <a href="#">Figure 20</a> , <a href="#">Figure 21</a> and <a href="#">Figure 24</a> . Added <a href="#">Figure 14</a> .
02-Apr-2014	5	Updated <a href="#">Figure 4</a> and <a href="#">Figure 5</a> .

**Please Read Carefully:**

Information in this document is provided solely in connection with ST products. STMicroelectronics NV and its subsidiaries ("ST") reserve the right to make changes, corrections, modifications or improvements, to this document, and the products and services described herein at any time, without notice.

All ST products are sold pursuant to ST's terms and conditions of sale.

Purchasers are solely responsible for the choice, selection and use of the ST products and services described herein, and ST assumes no liability whatsoever relating to the choice, selection or use of the ST products and services described herein.

No license, express or implied, by estoppel or otherwise, to any intellectual property rights is granted under this document. If any part of this document refers to any third party products or services it shall not be deemed a license grant by ST for the use of such third party products or services, or any intellectual property contained therein or considered as a warranty covering the use in any manner whatsoever of such third party products or services or any intellectual property contained therein.

**UNLESS OTHERWISE SET FORTH IN ST'S TERMS AND CONDITIONS OF SALE ST DISCLAIMS ANY EXPRESS OR IMPLIED WARRANTY WITH RESPECT TO THE USE AND/OR SALE OF ST PRODUCTS INCLUDING WITHOUT LIMITATION IMPLIED WARRANTIES OF MERCHANTABILITY, FITNESS FOR A PARTICULAR PURPOSE (AND THEIR EQUIVALENTS UNDER THE LAWS OF ANY JURISDICTION), OR INFRINGEMENT OF ANY PATENT, COPYRIGHT OR OTHER INTELLECTUAL PROPERTY RIGHT.**

**ST PRODUCTS ARE NOT DESIGNED OR AUTHORIZED FOR USE IN: (A) SAFETY CRITICAL APPLICATIONS SUCH AS LIFE SUPPORTING, ACTIVE IMPLANTED DEVICES OR SYSTEMS WITH PRODUCT FUNCTIONAL SAFETY REQUIREMENTS; (B) AERONAUTIC APPLICATIONS; (C) AUTOMOTIVE APPLICATIONS OR ENVIRONMENTS, AND/OR (D) AEROSPACE APPLICATIONS OR ENVIRONMENTS. WHERE ST PRODUCTS ARE NOT DESIGNED FOR SUCH USE, THE PURCHASER SHALL USE PRODUCTS AT PURCHASER'S SOLE RISK, EVEN IF ST HAS BEEN INFORMED IN WRITING OF SUCH USAGE, UNLESS A PRODUCT IS EXPRESSLY DESIGNATED BY ST AS BEING INTENDED FOR "AUTOMOTIVE, AUTOMOTIVE SAFETY OR MEDICAL" INDUSTRY DOMAINS ACCORDING TO ST PRODUCT DESIGN SPECIFICATIONS. PRODUCTS FORMALLY ESCC, QML OR JAN QUALIFIED ARE DEEMED SUITABLE FOR USE IN AEROSPACE BY THE CORRESPONDING GOVERNMENTAL AGENCY.**

Resale of ST products with provisions different from the statements and/or technical features set forth in this document shall immediately void any warranty granted by ST for the ST product or service described herein and shall not create or extend in any manner whatsoever, any liability of ST.

ST and the ST logo are trademarks or registered trademarks of ST in various countries.  
Information in this document supersedes and replaces all information previously supplied.

The ST logo is a registered trademark of STMicroelectronics. All other names are the property of their respective owners.

© 2014 STMicroelectronics - All rights reserved

STMicroelectronics group of companies

Australia - Belgium - Brazil - Canada - China - Czech Republic - Finland - France - Germany - Hong Kong - India - Israel - Italy - Japan - Malaysia - Malta - Morocco - Philippines - Singapore - Spain - Sweden - Switzerland - United Kingdom - United States of America

[www.st.com](http://www.st.com)



# AMEYA360

## Components Supply Platform

### Authorized Distribution Brand :



### Website :

Welcome to visit [www.ameya360.com](http://www.ameya360.com)

### Contact Us :

#### ➤ Address :

401 Building No.5, JiuGe Business Center, Lane 2301, Yishan Rd  
Minhang District, Shanghai , China

#### ➤ Sales :

Direct +86 (21) 6401-6692

Email [amall@ameya360.com](mailto:amall@ameya360.com)

QQ 800077892

Skype [ameyasales1](#) [ameyasales2](#)

#### ➤ Customer Service :

Email [service@ameya360.com](mailto:service@ameya360.com)

#### ➤ Partnership :

Tel +86 (21) 64016692-8333

Email [mkt@ameya360.com](mailto:mkt@ameya360.com)