

Standard Rectifier

$$V_{RRM} = 800V$$

$$I_{FAV} = 45A$$

$$V_F = 1.23V$$

Single Diode

Part number

DSI45-08A

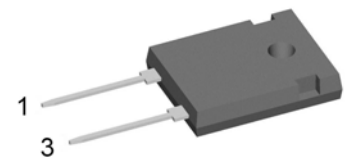

Backside: cathode

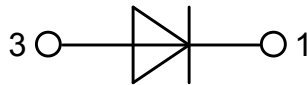

Features / Advantages:

- Planar passivated chips
- Very low leakage current
- Very low forward voltage drop
- Improved thermal behaviour

Applications:

- Diode for main rectification
- For single and three phase bridge configurations

Package: TO-247

- Industry standard outline
- RoHS compliant
- Epoxy meets UL 94V-0

| Rectifier | | | | Ratings | | |
|------------|--|-------------------------------------|-------------------------|---------|------|-------------------|
| Symbol | Definition | Conditions | min. | typ. | max. | Unit |
| V_{RSM} | max. non-repetitive reverse blocking voltage | $T_{VJ} = 25^{\circ}C$ | | | 900 | V |
| V_{RRM} | max. repetitive reverse blocking voltage | $T_{VJ} = 25^{\circ}C$ | | | 800 | V |
| I_R | reverse current, drain current | $V_R = 800 V$ | $T_{VJ} = 25^{\circ}C$ | | 40 | μA |
| | | $V_R = 800 V$ | $T_{VJ} = 150^{\circ}C$ | | 1.5 | mA |
| V_F | forward voltage drop | $I_F = 45 A$ | $T_{VJ} = 25^{\circ}C$ | | 1.26 | V |
| | | $I_F = 90 A$ | | | 1.57 | V |
| | | $I_F = 45 A$ | $T_{VJ} = 150^{\circ}C$ | | 1.23 | V |
| | | $I_F = 90 A$ | | | 1.66 | V |
| I_{FAV} | average forward current | $T_C = 130^{\circ}C$ 180° sine | $T_{VJ} = 175^{\circ}C$ | | 45 | A |
| V_{FO} | threshold voltage | } for power loss calculation only | $T_{VJ} = 175^{\circ}C$ | | 0.81 | V |
| r_F | slope resistance | | | | 9.1 | m Ω |
| R_{thJC} | thermal resistance junction to case | | | | 0.55 | K/W |
| R_{thCH} | thermal resistance case to heatsink | | | 0.25 | | K/W |
| P_{tot} | total power dissipation | | $T_C = 25^{\circ}C$ | | 270 | W |
| I_{FSM} | max. forward surge current | $t = 10 \text{ ms; (50 Hz), sine}$ | $T_{VJ} = 45^{\circ}C$ | | 480 | A |
| | | $t = 8,3 \text{ ms; (60 Hz), sine}$ | $V_R = 0 V$ | | 520 | A |
| | | $t = 10 \text{ ms; (50 Hz), sine}$ | $T_{VJ} = 150^{\circ}C$ | | 410 | A |
| | | $t = 8,3 \text{ ms; (60 Hz), sine}$ | $V_R = 0 V$ | | 440 | A |
| I^2t | value for fusing | $t = 10 \text{ ms; (50 Hz), sine}$ | $T_{VJ} = 45^{\circ}C$ | | 1.15 | kA ² s |
| | | $t = 8,3 \text{ ms; (60 Hz), sine}$ | $V_R = 0 V$ | | 1.13 | kA ² s |
| | | $t = 10 \text{ ms; (50 Hz), sine}$ | $T_{VJ} = 150^{\circ}C$ | | 840 | A ² s |
| | | $t = 8,3 \text{ ms; (60 Hz), sine}$ | $V_R = 0 V$ | | 805 | A ² s |
| C_J | junction capacitance | $V_R = 400 V; f = 1 \text{ MHz}$ | $T_{VJ} = 25^{\circ}C$ | | 18 | pF |

| Package TO-247 | | | Ratings | | | |
|----------------|------------------------------|--------------|---------|------|------|------|
| Symbol | Definition | Conditions | min. | typ. | max. | Unit |
| I_{RMS} | RMS current | per terminal | | | 70 | A |
| T_{stg} | storage temperature | | -55 | | 150 | °C |
| T_{vj} | virtual junction temperature | | -40 | | 175 | °C |
| Weight | | | | 6 | | g |
| M_D | mounting torque | | 0.8 | | 1.2 | Nm |
| F_C | mounting force with clip | | 20 | | 120 | N |

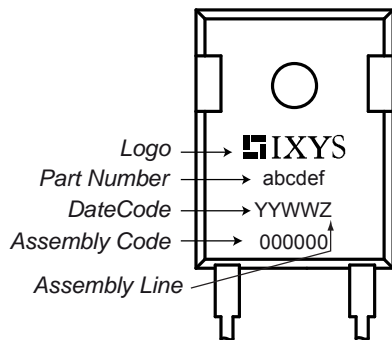
Product Marking

| Ordering | Part Number | Marking on Product | Delivery Mode | Quantity | Code No. |
|----------|-------------|--------------------|---------------|----------|----------|
| Standard | DSI45-08A | DSI45-08A | Tube | 30 | 471887 |

| Similar Part | Package | Voltage class |
|--------------|----------------|---------------|
| DSI45-12A | TO-247AD (2) | 1200 |
| DSI45-16A | TO-247AD (2) | 1600 |
| DSI45-16AR | ISOPLUS247 (2) | 1600 |

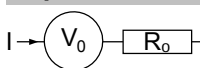
Equivalent Circuits for Simulation
** on die level*
 $T_{vj} = 175^{\circ}\text{C}$

Rectifier

| | | | |
|-------------|--------------------|------|----|
| $V_{0\max}$ | threshold voltage | 0.81 | V |
| $R_{0\max}$ | slope resistance * | 6.5 | mΩ |

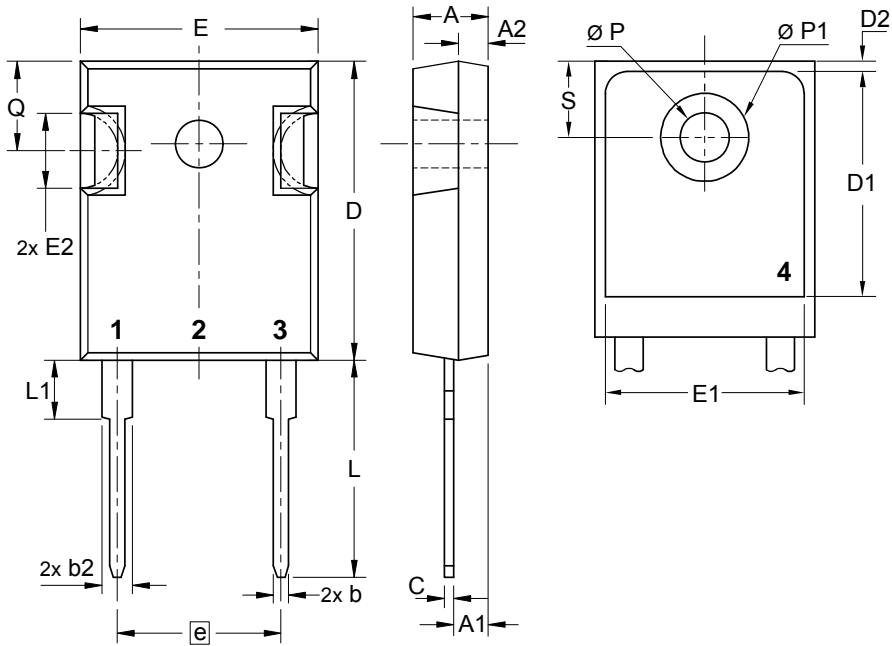
Outlines TO-247

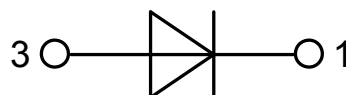

| Sym. | Inches | | Millimeter | |
|------|-----------|-------|------------|-------|
| | min. | max. | min. | max. |
| A | 0.185 | 0.209 | 4.70 | 5.30 |
| A1 | 0.087 | 0.102 | 2.21 | 2.59 |
| A2 | 0.059 | 0.098 | 1.50 | 2.49 |
| D | 0.819 | 0.845 | 20.79 | 21.45 |
| E | 0.610 | 0.640 | 15.48 | 16.24 |
| E2 | 0.170 | 0.216 | 4.31 | 5.48 |
| e | 0.430 BSC | | 10.92 BSC | |
| L | 0.780 | 0.800 | 19.80 | 20.30 |
| L1 | - | 0.177 | - | 4.49 |
| Ø P | 0.140 | 0.144 | 3.55 | 3.65 |
| Q | 0.212 | 0.244 | 5.38 | 6.19 |
| S | 0.242 BSC | | 6.14 BSC | |
| b | 0.039 | 0.055 | 0.99 | 1.40 |
| b2 | 0.065 | 0.094 | 1.65 | 2.39 |
| b4 | 0.102 | 0.135 | 2.59 | 3.43 |
| c | 0.015 | 0.035 | 0.38 | 0.89 |
| D1 | 0.515 | - | 13.07 | - |
| D2 | 0.020 | 0.053 | 0.51 | 1.35 |
| E1 | 0.530 | - | 13.45 | - |
| Ø P1 | - | 0.29 | - | 7.39 |



Rectifier

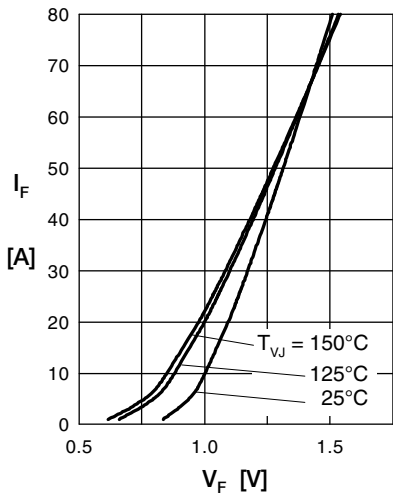

Fig. 1 Forward current versus voltage drop per diode

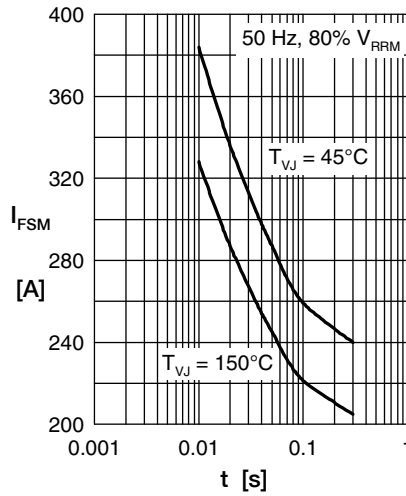

Fig. 2 Surge overload current

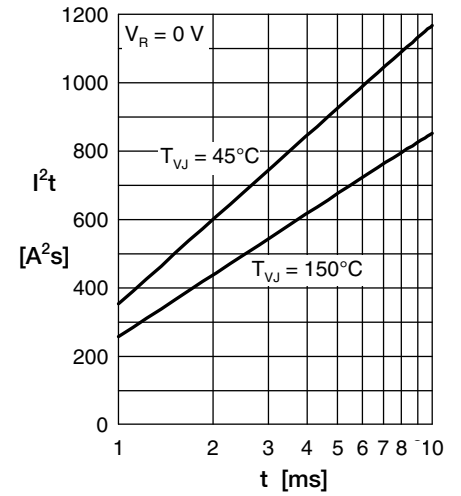

Fig. 3 I^2t versus time per diode

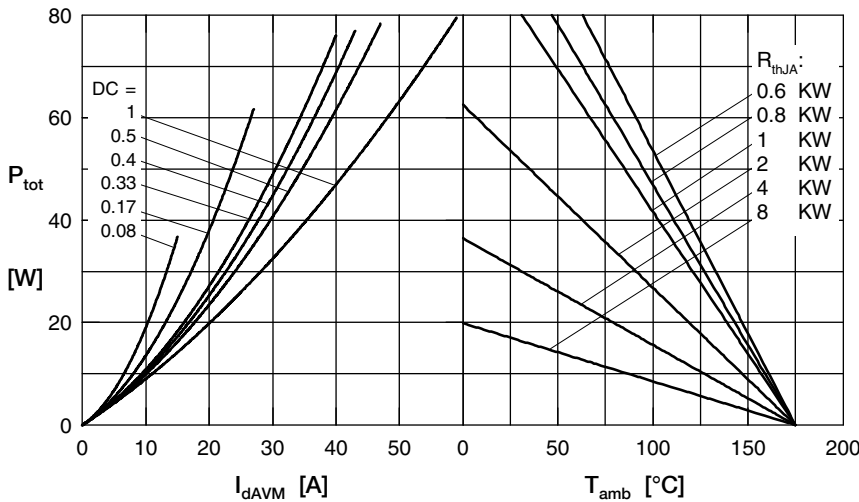

Fig. 4 Power dissipation vs. direct output current & ambient temperature

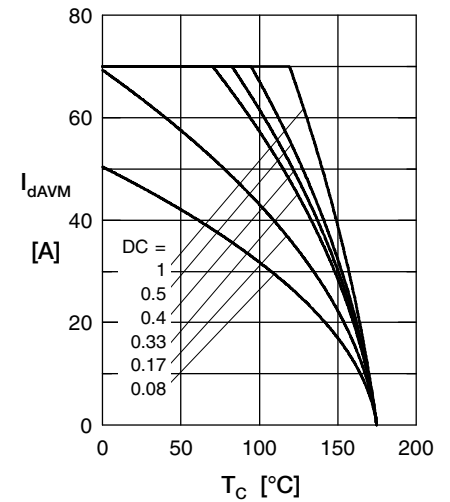

Fig. 5 Max. forward current vs. case temperature

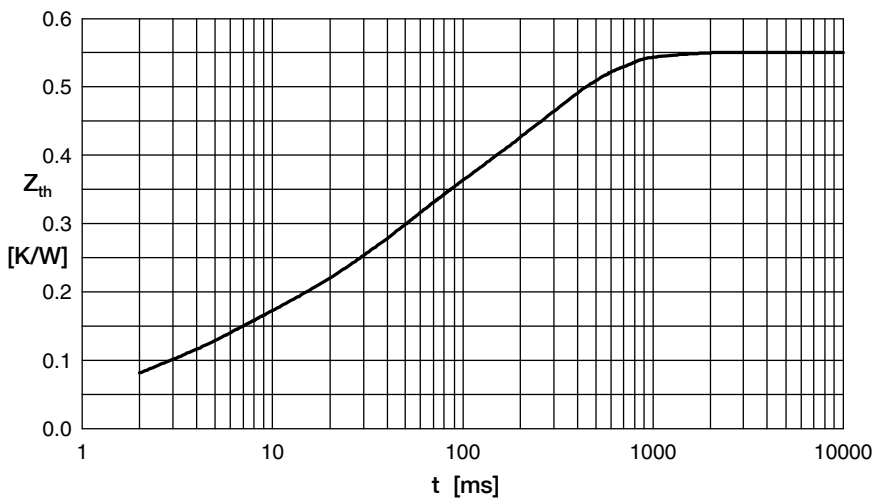

Fig. 6 Transient thermal impedance junction to case

| i | R_i | t_i |
|---|-------|--------|
| 1 | 0.033 | 0.0006 |
| 2 | 0.095 | 0.0039 |
| 3 | 0.164 | 0.033 |
| 4 | 0.258 | 0.272 |

AMEYA360

Components Supply Platform

Authorized Distribution Brand :



Website :

Welcome to visit www.ameya360.com

Contact Us :

➤ Address :

401 Building No.5, JiuGe Business Center, Lane 2301, Yishan Rd
Minhang District, Shanghai , China

➤ Sales :

Direct +86 (21) 6401-6692

Email amall@ameya360.com

QQ 800077892

Skype [ameyasales1](#) [ameyasales2](#)

➤ Customer Service :

Email service@ameya360.com

➤ Partnership :

Tel +86 (21) 64016692-8333

Email mkt@ameya360.com