

Features

Regulated Converters

- High Output Voltage DIP24 converter
- Improved Version of Rxx-100_150A Series with higher efficiency and reduced ripple.
- Input Voltage 5, 12, 15 or 24VDC
- Adjustable Output Voltage up to 210VDC
- Cascadable for Output Voltages up to 420VDC
- 3kVDC Input/Output Isolation
- Remote Voltage Programming by External Voltage or Resistance
- Continuous Short Circuit Protection
- Ambient Temperature up to +85°C

Selection Guide

Part Number	Input Range (VDC)	Output Voltage Range (VDC)	Max Output Current (mA)	Efficiency at Full Load (%)
R05-100B	5 (4.5 – 6)	+40...+120	25	77
R12-100B	12 (10 – 14)	+55...+135	50	82
R15-100B	15 (14 – 17)	+55...+135	50	82
R24-100B	24 (21 – 27)	+55...+135	50	84
R12-150B	12 (10 – 14)	+95...+210	50	82
R15-150B	15 (14 – 17)	+95...+210	50	82
R24-150B	24 (21 – 27)	+95...+210	50	84

Specifications (typical at 25°C, nominal input voltage, full load unless otherwise specified)

Input Voltage Range	5, 12, 15 or 24VDC	
Rated Power	5V	25mA max. or 3 Watts max.
	All others	50mA max. or 5 Watts max.
Output Voltage Adjustment Range	55..135 or 95..210VDC	
Output Voltage Accuracy	±5% max	
Line Voltage Regulation	0.5% max	
Load Voltage Regulation	20% to 100% full load	0.5% max
Output Ripple and Noise	20MHz limited	60mVp-p typ. / 100mVp-p max.
Operating Frequency	200kHz typ.	
Efficiency at Full Load	80 ~ 86% typ.	
Isolation Voltage (tested for 1 second)	3000VDC min.	
Isolation Capacitance	20pF typ.	
Isolation Resistance	1 GΩ min.	
Short Circuit Protection	Continuous, Automatic Restart	
Short Circuit Input Current	30mA typ.	
Temperature Coefficient	±0.02%/°C	
Operating Temperature Range (free air convection)	With derating	-40°C to +85°C
	Full Power	-40°C to +70°C
Storage Temperature Range	-50°C to +125°C	
Case Material	Non-Conductive Black Plastic	
Potting Material	Epoxy (UL94V-0)	
Weight	12g	
MTBF (25°C)	Mil-Std 217F	1400 x 10 ³ hours
Output Voltage Adjust	External Voltage	0 - 4VDC
	External Resistor	0 - 5kΩ
Internal Voltage Reference	Regulated 5V with 1kΩ series resistor	
EN General Safety	Report: SPCLVD 1207005	EN60950-1:2006 + A12:2011

INNOLINE

DC/DC-Converter

with 3 year Warranty

RECOM

5 Watt Single Output

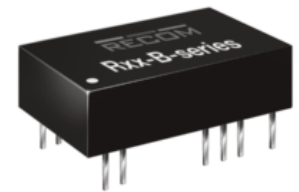

EN-60950-1 Certified

Rxx-B

Derating-Graph (Ambient Temperature)

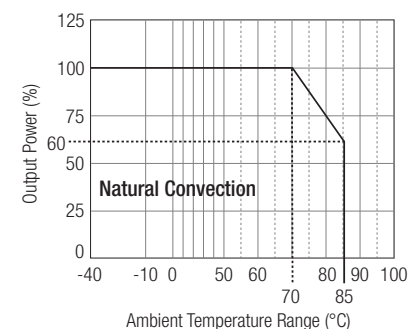

Refer to Application Notes

Typical Applications

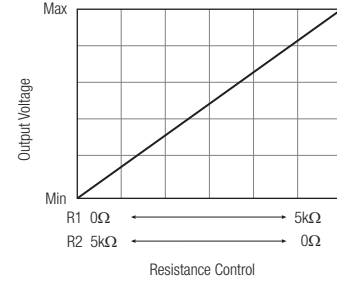
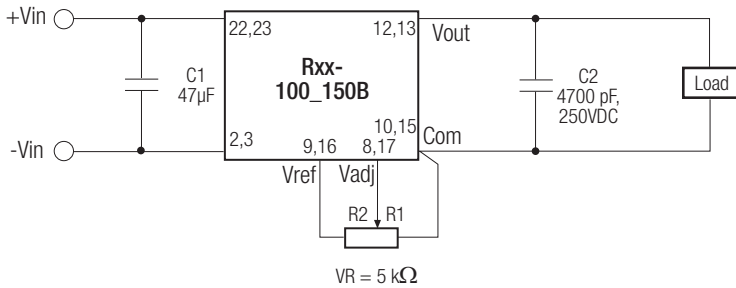

For remote voltage control

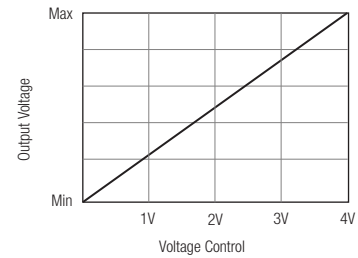
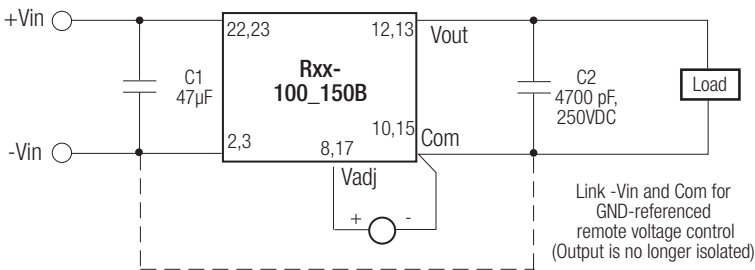

R-xxB

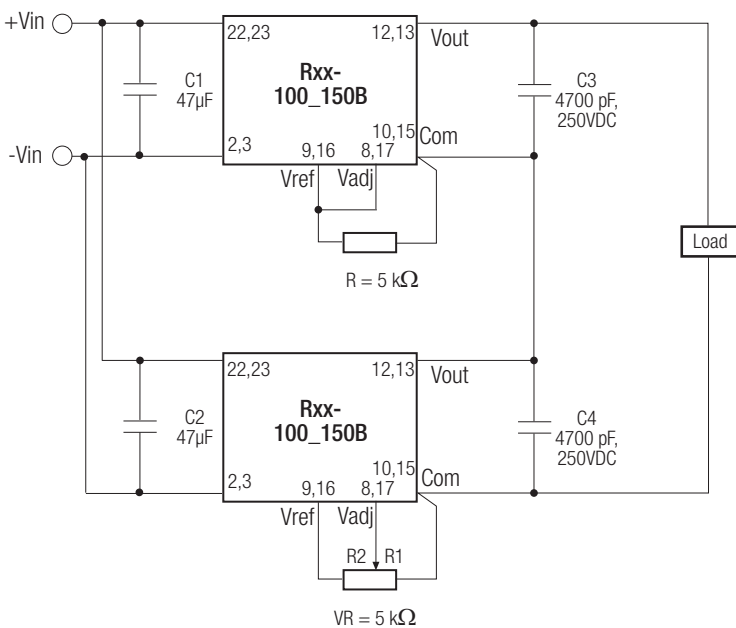

Cascade Combinations

U1	U2	Vout Range
R05-100B	R05-100B	160-240
Rxx-100B	Rxx-100B	190~270
Rxx-150B	Rxx-100B	230~345
Rxx-150B	Rxx-150B	305~420

xx = 12, 15 or 24

Note: When cascaded, only one Rxx-B may be adjustable, the other must be fixed voltage.

Typical Characteristics

R24-100B _ R24-150B

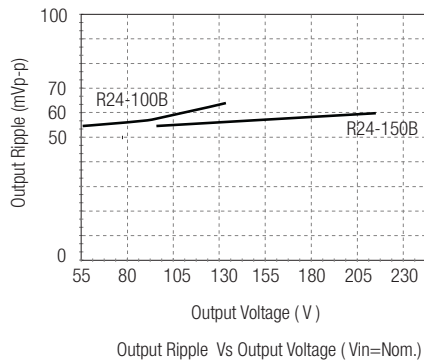

R24-100B _ R24-150B

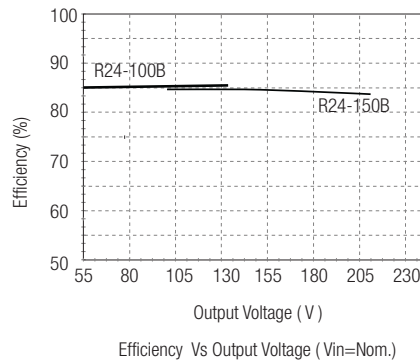

Power Limit

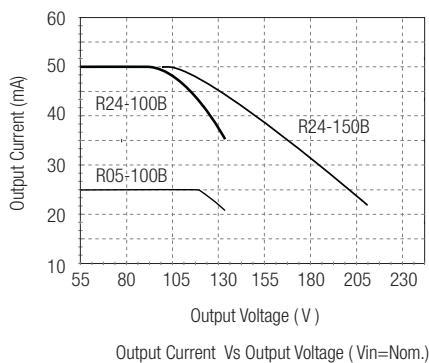

Package Style and Pinning

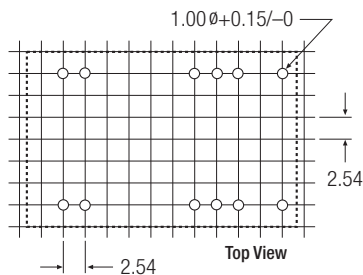
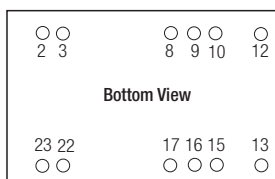
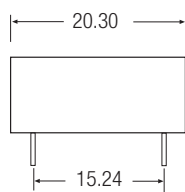
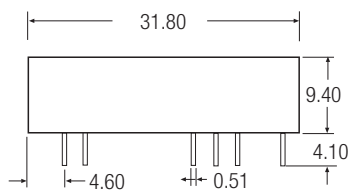

Pin Connections

Pin #	Out
2,3	-Vin
8,17	Vadj
9,16	V ref
10,15	-Vout
12,13	+Vout
22,23	+Vin
XX.X	± 0.5 mm
XX.XX	± 0.25 mm

The product information and specifications are subject to change without prior notice. RECOM products are not authorized for use in safety-critical applications (such as life support) without RECOM's explicit written consent. A safety-critical application is defined as an application where a failure of a RECOM product may reasonably be expected to endanger or cause loss of life, inflict bodily harm or damage property. The buyer shall indemnify and hold harmless RECOM, its affiliated companies and its representatives against any damage claims in connection with the unauthorized use of RECOM products in such safety-critical applications.

AMEYA360

Components Supply Platform

Authorized Distribution Brand :



Website :

Welcome to visit www.ameya360.com

Contact Us :

➤ Address :

401 Building No.5, JiuGe Business Center, Lane 2301, Yishan Rd
Minhang District, Shanghai , China

➤ Sales :

Direct +86 (21) 6401-6692

Email amall@ameya360.com

QQ 800077892

Skype [ameyasales1](#) [ameyasales2](#)

➤ Customer Service :

Email service@ameya360.com

➤ Partnership :

Tel +86 (21) 64016692-8333

Email mkt@ameya360.com