

NLAS4501

Single SPST Analog Switch

The NLAS4501 is an analog switch manufactured in sub-micron silicon-gate CMOS technology. It achieves very low R_{ON} while maintaining extremely low power dissipation. The device is a bilateral switch suitable for switching either analog or digital signals, which may vary from zero to full supply voltage.

The NLAS4501 is pin-for-pin compatible with the MAX4501. The NLAS4501 can be used as a direct replacement for the MAX4501 in all 2.0 V to 5.5 V applications where a R_{ON} performance improvement is required.

The Enable pin is compatible with standard CMOS outputs when supply voltage is nominal 5.0 Volts. It is also over-voltage tolerant, making it a very useful logic level translator.

- Guaranteed R_{ON} of 32 Ω at 5.5 V
- Low Power Dissipation: $I_{CC} = 2 \mu A$
- Provides Voltage translation for many different voltage levels
3.3 to 5.0 V, Enable pin may go as high as +5.5 Volts
1.8 to 3.3 V
1.8 to 2.5 V
- Improved version of MAX4501 (at any voltage between 2 and 5.5 Volts)
- Chip Complexity: FETs 11
- Pb-Free Packages are Available

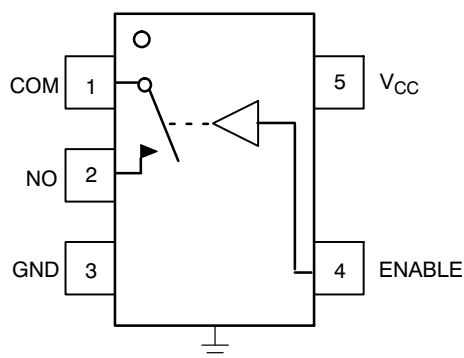

Figure 1. Pinout (Top View)



ON Semiconductor®

<http://onsemi.com>

MARKING DIAGRAMS



SC70-5/SC-88A/SOT-353
DF SUFFIX
CASE 419A

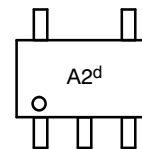

SOT23-5/TSOP-5/SC59-5
DT SUFFIX
CASE 483

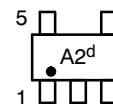

d = Date Code

PIN ASSIGNMENT

PIN ASSIGNMENT	
1	COM
2	NO
3	GND
4	ENABLE
5	V_{CC}

FUNCTION TABLE

On/Off Enable Input	State of Analog Switch
L	Off
H	On

ORDERING INFORMATION

See detailed ordering and shipping information on page 7 of this data sheet.

NLAS4501

MAXIMUM RATINGS

Symbol	Parameter	Value	Unit	
V _{CC}	Positive DC Supply Voltage	-0.5 to +7.0	V	
V _{IN}	Digital Input Voltage (Enable)	-0.5 to +7.0	V	
V _{IS}	Analog Output Voltage (V _{NO} or V _{COM})	-0.5 to V _{CC} +0.5	V	
I _{IK}	DC Current, Into or Out of Any Pin	±20	mA	
T _{STG}	Storage Temperature Range	-65 to +150	°C	
T _L	Lead Temperature, 1 mm from Case for 10 Seconds	260	°C	
T _J	Junction Temperature under Bias	+150	°C	
θ _{JA}	Thermal Resistance	SC70-5/SC-88A (Note 1) TSOP-5	350 230	°C/W
P _D	Power Dissipation in Still Air at 85°C	SC70-5/SC-88A TSOP-5	150 200	mW
MSL	Moisture Sensitivity	Level 1		
F _R	Flammability Rating	Oxygen Index: 30% - 35%	UL-94-VO (0.125 in)	
V _{ESD}	ESD Withstand Voltage	Human Body Model (Note 2) Machine Model (Note 3) Charged Device Model (Note 4)	> 2000 > 100 N/A	V
I _{Latch-Up}	Latch-Up Performance	Above V _{CC} and Below GND at 85°C (Note 5)	±300	mA

Maximum ratings are those values beyond which device damage can occur. Maximum ratings applied to the device are individual stress limit values (not normal operating conditions) and are not valid simultaneously. If these limits are exceeded, device functional operation is not implied, damage may occur and reliability may be affected.

1. Measured with minimum pad spacing on an FR4 board, using 10 mm-by-1 inch, 2-ounce copper trace with no air flow.
2. Tested to EIA/JESD22-A114-A.
3. Tested to EIA/JESD22-A115-A.
4. Tested to JESD22-C101-A.
5. Tested to EIA/JESD78.

RECOMMENDED OPERATING CONDITIONS

Symbol	Characteristics	Min	Max	Unit
V _{CC}	Positive DC Supply Voltage	2.0	5.5	V
V _{IN}	Digital Input Voltage (Enable)	GND	5.5	V
V _{IO}	Static or Dynamic Voltage Across an Off Switch	GND	V _{CC}	V
V _{IS}	Analog Input Voltage (NO, COM)	GND	V _{CC}	V
T _A	Operating Temperature Range, All Package Types	-55	+125	°C
t _r , t _f	Input Rise or Fall Time, (Enable Input)	V _{CC} = 3.3 V ± 0.3 V V _{CC} = 5.0 V ± 0.5 V	0 100 20	ns/V

DEVICE JUNCTION TEMPERATURE VERSUS TIME TO 0.1% BOND FAILURES

Junction Temperature °C	Time, Hours	Time, Years
80	1,032,200	117.8
90	419,300	47.9
100	178,700	20.4
110	79,600	9.4
120	37,000	4.2
130	17,800	2.0
140	8,900	1.0

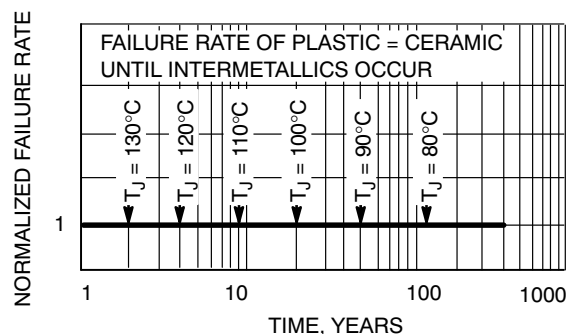

Figure 2. Failure Rate vs. Time Junction Temperature

NLAS4501

DC CHARACTERISTICS – Digital Section (Voltages Referenced to GND)

Symbol	Parameter	Condition	V _{CC}	-40°C to +85°C			Unit
				Min	Typ	Max	
V _{IH}	Minimum High-Level Input Voltage, Enable Inputs		2.0	1.5	-	-	V
			3.0	2.1	-	-	
			4.5	3.15	-	-	
			5.5	3.85	-	-	
V _{IL}	Maximum Low-Level Input Voltage, Enable Inputs		2.0	-	-	0.5	V
			3.0	-	-	0.9	
			4.5	-	-	1.35	
			5.5	-	-	1.65	
I _{IN}	Maximum Input Leakage Current, Enable Inputs	V _{IN} = 5.5 V or GND	0 V to 5.5 V	-	±0.1	±1.0	µA
I _{CC}	Maximum Quiescent Supply Current (per package)	Enable and VIS = V _{CC} or GND	5.5	-	-	1.0	µA

DC ELECTRICAL CHARACTERISTICS – Analog Section

Symbol	Parameter	Condition	V _{CC}	-40°C to +85°C			Unit
				Min	Typ	Max	
R _{ON}	Maximum ON Resistance (Figures 8 - 12)	V _{IN} = V _{IH} V _{IS} = V _{CC} to GND I _{IS} = ≤10.0mA	3.0	-	45	50	Ω
			4.5	-	30	35	
			5.5	-	25	25	
R _{FLAT(ON)}	ON Resistance Flatness	V _{IN} = V _{IH} I _{IS} = ≤10.0mA V _{IS} = 1V, 2V, 3.5V	4.5	-	4.0	4.0	Ω
I _{NO(OFF)}	Off Leakage Current, Pin 2 (Figure 3)	V _{IN} = V _{IL} V _{NO} = 1.0 V, V _{COM} = 4.5 V or V _{COM} = 1.0 V and V _{NO} 4.5 V	5.5	-	1.0	100	nA
I _{COM(OFF)}	Off Leakage Current, Pin 1 (Figure 3)	V _{IN} = V _{IL} V _{NO} = 4.5 V or 1.0 V V _{COM} = 1.0 V or 4.5 V	5.5	-	1.0	100	nA

AC ELECTRICAL CHARACTERISTICS (Input t_r = t_f = 3.0 ns)

Symbol	Parameter	Test Conditions	V _{CC} (V)	Guaranteed Max Limit									Unit
				-55 to 25°C			<85°C			<125°C			
				Min	Typ	Max	Min	Typ	Max	Min	Typ	Max	
t _{ON}	Turn-On Time	R _L = 300 Ω, C _L = 35 pF (Figures 4, 5, and 13)	2.0		7.0	14			16			16	ns
			3.0		5.0	10			12			12	
			4.5		4.5	9			11			11	
			5.5		4.5	9			11			11	
t _{OFF}	Turn-Off Time	R _L = 300 Ω, C _L = 35 pF (Figures 4, 5, and 13)	2.0		11.0	22			24			24	ns
			3.0		7.0	14			16			16	
			4.5		5.0	10			12			12	
			5.5		5.0	10			12			12	

		Typical @ 25, V _{CC} = 5.0 V			
C _{IN}	Maximum Input Capacitance, Select Input	8			pF
C _{NO} or C _{NC}	Analog I/O (switch off)	10			
C _{COM(OFF)}	Common I/O (switch off)	10			
C _{COM(ON)}	Feedthrough (switch on)	20			

NLAS4501

ADDITIONAL APPLICATION CHARACTERISTICS (Voltages Referenced to GND Unless Noted)

Symbol	Parameter	Condition	V _{CC} V	Limit	Unit
				25°C	
BW	Maximum On-Channel -3dB Bandwidth or Minimum Frequency Response	V _{IS} = 0 dBm V _{IS} centered between V _{CC} and GND (Figures 6 and 14)	3.0 4.5 5.5	190 200 220	MHz
V _{ONL}	Maximum Feedthrough On Loss	V _{IS} = 0 dBm @ 10 kHz V _{IS} centered between V _{CC} and GND (Figure 6)	3.0 4.5 5.5	-2 -2 -2	dB
V _{ISO}	Off-Channel Isolation	f = 100 kHz; V _{IS} = 1 V RMS V _{IS} centered between V _{CC} and GND (Figures 6 and 15)	3.0 4.5 5.5	-93	dB
Q	Charge Injection Enable Input to Common I/O	V _{IS} = V _{CC} to GND, F _{IS} = 20 kHz t _r = t _f = 3 ns R _{IS} = 0 Ω, C _L = 1000 pF Q = C _L * ΔV _{OUT} (Figures 7 and 16)	3.0 5.5	1.5 3.0	pC
THD	Total Harmonic Distortion THD + Noise	F _{IS} = 20 Hz to 1 MHz, R _L = R _{gen} = 600 Ω, C _L = 50 pF V _{IS} = 3.0 V _{PP} sine wave V _{IS} = 5.0 V _{PP} sine wave (Figure 17)	3.3 5.5	0.3 0.15	%

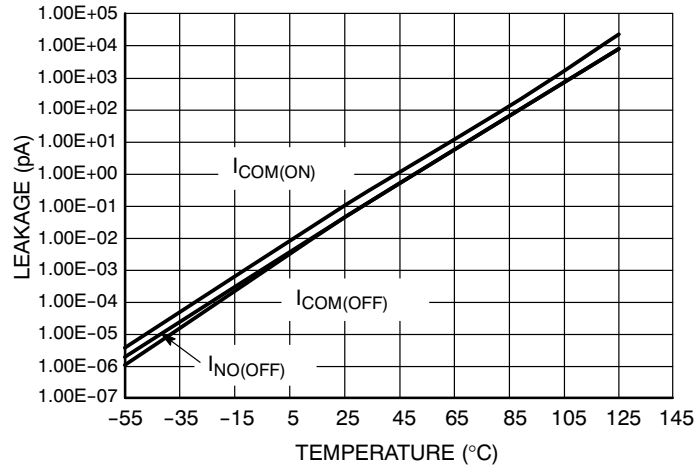

Figure 3. Switch Leakage vs. Temperature

NLAS4501

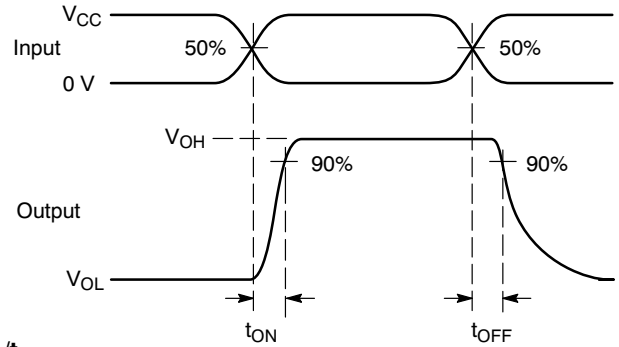
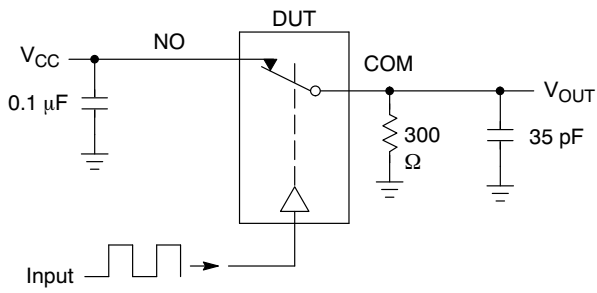

Figure 4. t_{ON}/t_{OFF}

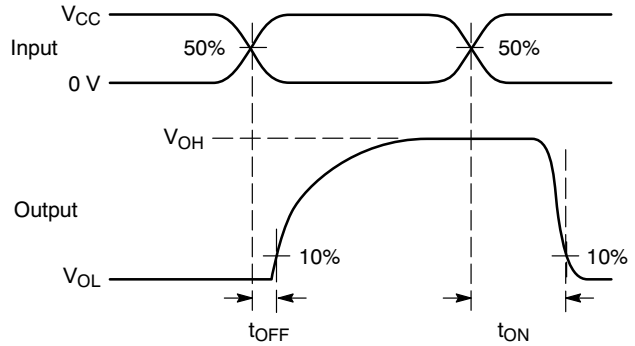
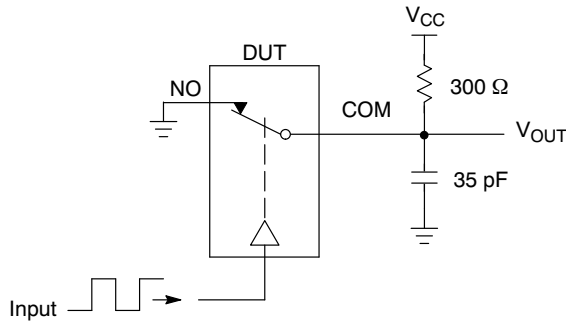
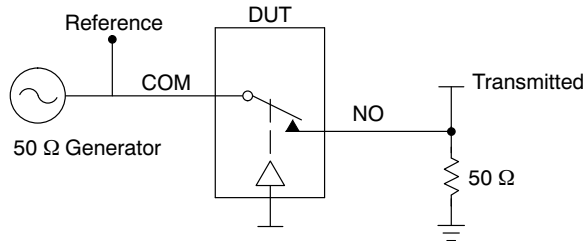

Figure 5. t_{ON}/t_{OFF}



Channel switch control/s test socket is normalized. Off isolation is measured across an off channel. On loss is the bandwidth of an On switch. V_{ISO} , Bandwidth and V_{ONL} are independent of the input signal direction.
 V_{ISO} = Off Channel Isolation = $20 \text{ Log} \left(\frac{V_{OUT}}{V_{IN}} \right)$ for V_{IN} at 100 kHz
 V_{ONL} = On Channel Loss = $20 \text{ Log} \left(\frac{V_{OUT}}{V_{IN}} \right)$ for V_{IN} at 100 kHz to 50 MHz
 Bandwidth (BW) = the frequency 3 dB below V_{ONL}

Figure 6. Off Channel Isolation/On Channel Loss (BW)/Crosstalk (On Channel to Off Channel)/ V_{ONL}

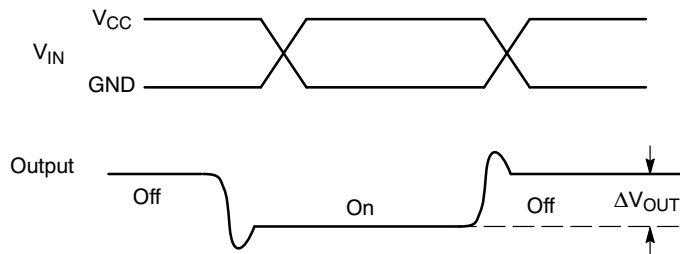
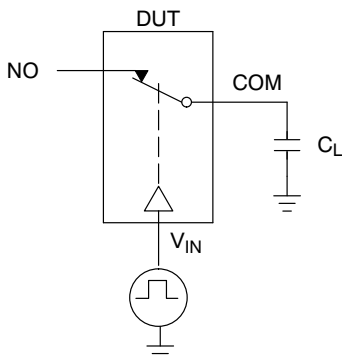

Figure 7. Charge Injection: (Q)

NLAS4501

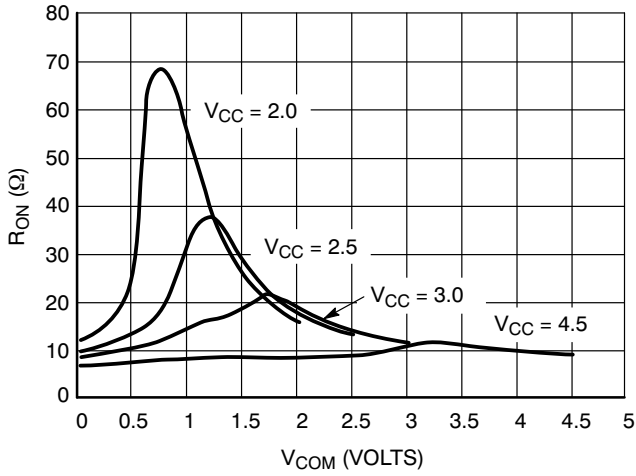

Figure 8. R_{ON} vs. V_{COM} and V_{CC} (@25°C)

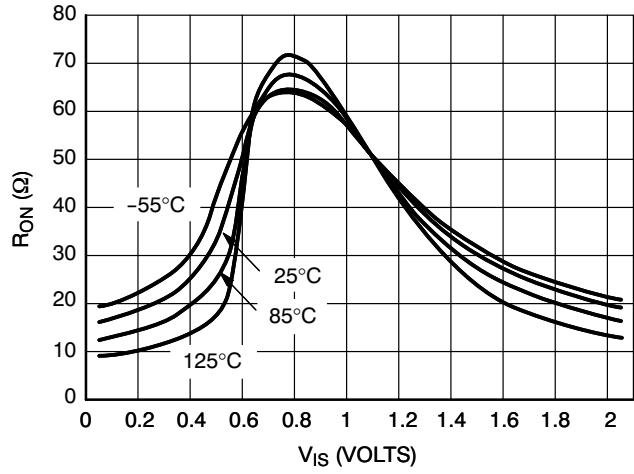

Figure 9. R_{ON} vs. V_{COM} and Temperature, $V_{CC} = 2.0$ V

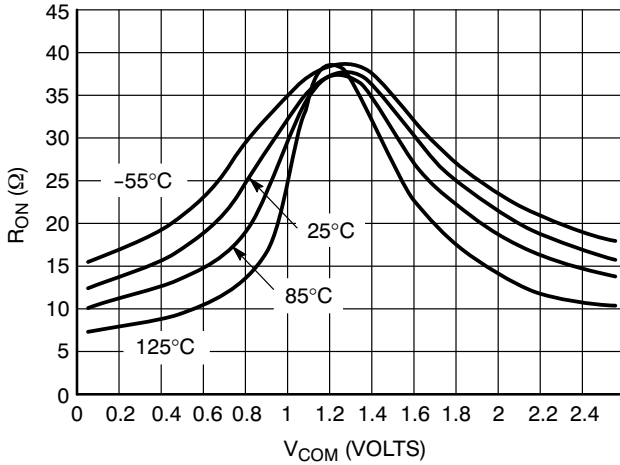

Figure 10. R_{ON} vs. V_{COM} and Temperature, $V_{CC} = 2.5$ V

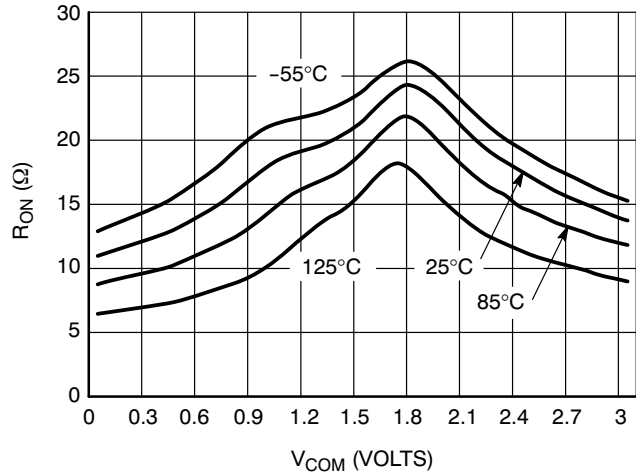

Figure 11. R_{ON} vs. V_{COM} and Temperature, $V_{CC} = 3.0$ V

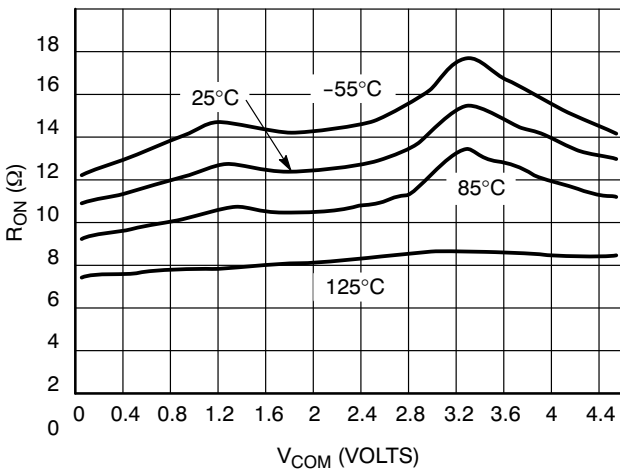

Figure 12. R_{ON} vs. V_{COM} and Temperature, $V_{CC} = 4.5$ V

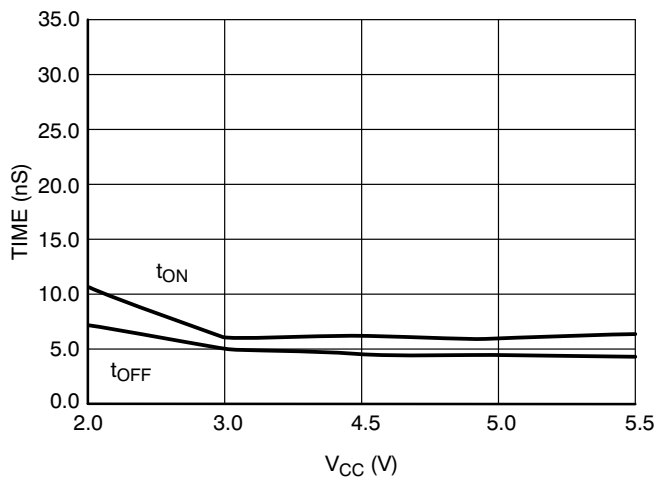

Figure 13. Switching Time vs. Supply Voltage, $T = 25^\circ\text{C}$

NLAS4501

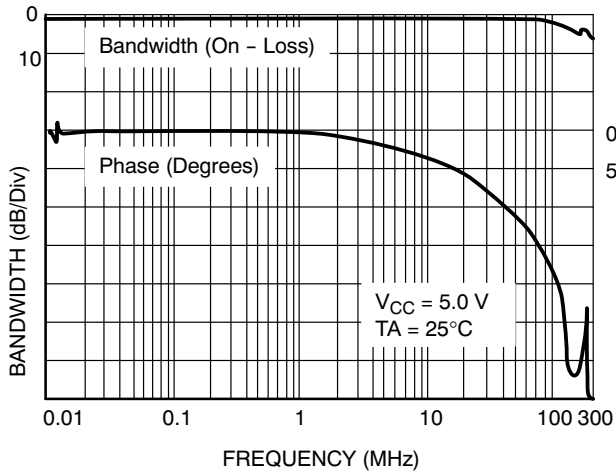

Figure 14. ON Channel Bandwidth and Phase Shift Over Frequency

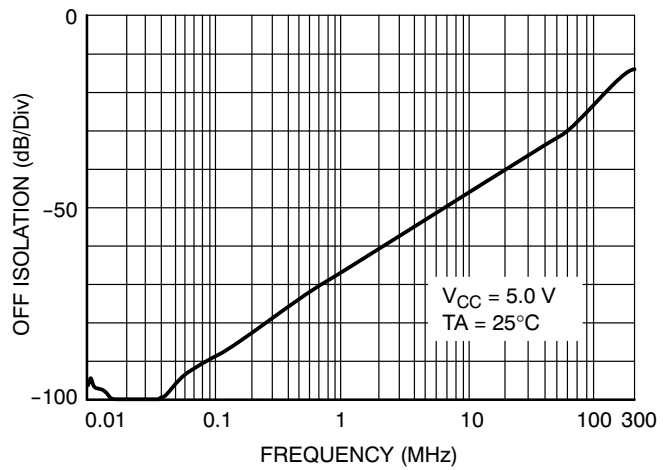

Figure 15. Off Channel Isolation

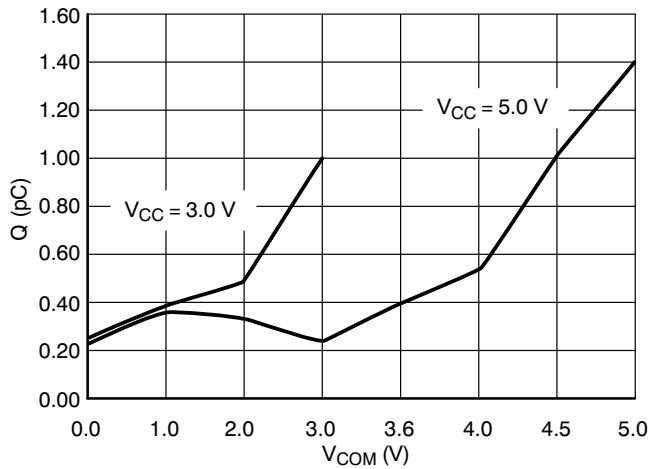

Figure 16. Charge Injection vs. V_{COM}

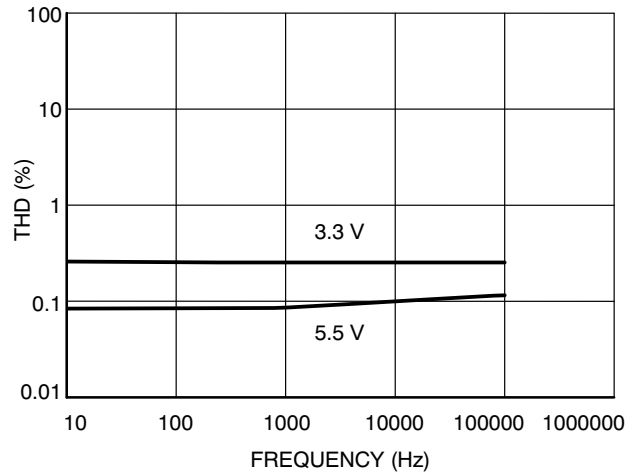

Figure 17. THD vs. Frequency

DEVICE ORDERING INFORMATION

Device Order Number	Device Nomenclature					Package Type	Shipping [†]
	Circuit Indicator	Technology	Device Function	Package Suffix	Tape & Reel Suffix		
NLAS4501DFT2	NL	AS	4501	DF	T2	SC-88A	178 mm (7) 3000 / Tape & Reel
NLAS4501DFT2G	NL	AS	4501	DF	T2	SC-88A (Pb-Free)	178 mm (7) 3000 / Tape & Reel
NLAS4501DTT1	NL	AS	4501	DT	T1	SOT-23/TSOP-5	178 mm (7 inch) 3000 / Tape & Reel
NLAS4501DTT1G	NL	AS	4501	DT	T1	SOT-23/TSOP-5 (Pb-Free)	178 mm (7 inch) 3000 / Tape & Reel

[†]For information on tape and reel specifications, including part orientation and tape sizes, please refer to our Tape and Reel Packaging Specifications Brochure, BRD8011/D.

NLAS4501

PACKAGE DIMENSIONS

SC-88A, SOT-353, SC-70
 DF SUFFIX
 CASE 419A-02
 ISSUE J

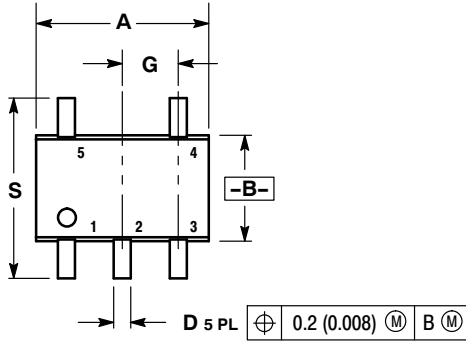

NOTES:

1. DIMENSIONING AND TOLERANCING PER ANSI Y14.5M, 1982.
2. CONTROLLING DIMENSION: INCH.
3. 419A-01 OBSOLETE. NEW STANDARD 419A-02.
4. DIMENSIONS A AND B DO NOT INCLUDE MOLD FLASH, PROTRUSIONS, OR GATE BURRS.

DIM	INCHES		MILLIMETERS	
	MIN	MAX	MIN	MAX
A	0.071	0.087	1.80	2.20
B	0.045	0.053	1.15	1.35
C	0.031	0.043	0.80	1.10
D	0.004	0.012	0.10	0.30
G	0.026 BSC		0.65 BSC	
H	---	0.004	---	0.10
J	0.004	0.010	0.10	0.25
K	0.004	0.012	0.10	0.30
N	0.008 REF		0.20 REF	
S	0.079	0.087	2.00	2.20

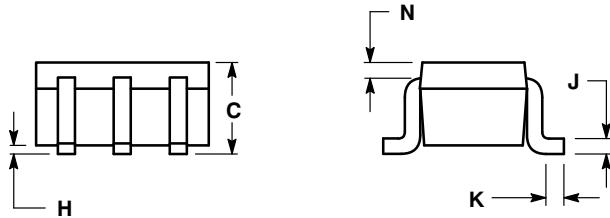

SOLDERING FOOTPRINT*

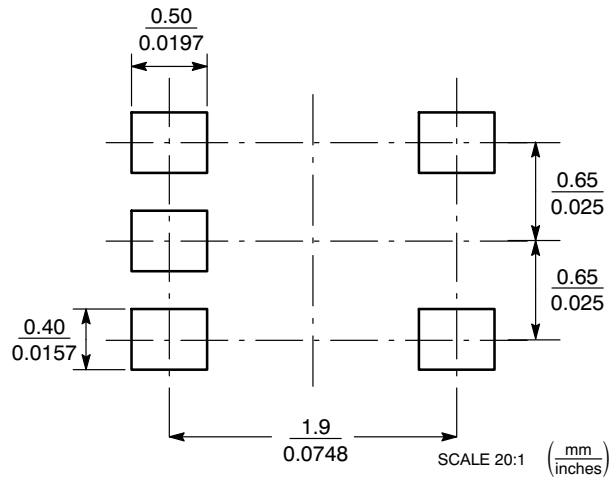

*For additional information on our Pb-Free strategy and soldering details, please download the ON Semiconductor Soldering and Mounting Techniques Reference Manual, SOLDERRM/D.

NLAS4501

PACKAGE DIMENSIONS

SOT23-5/TSOP-5/SC59-5
DT SUFFIX
CASE 483-02
ISSUE H

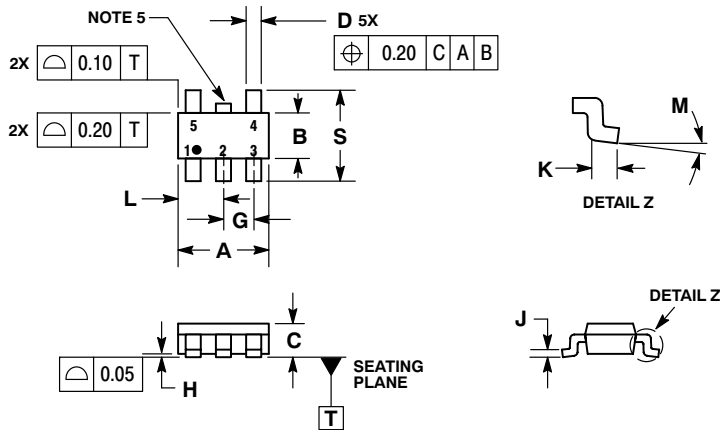

NOTES:

1. DIMENSIONING AND TOLERANCING PER ASME Y14.5M, 1994.
2. CONTROLLING DIMENSION: MILLIMETERS.
3. MAXIMUM LEAD THICKNESS INCLUDES LEAD FINISH THICKNESS. MINIMUM LEAD THICKNESS IS THE MINIMUM THICKNESS OF BASE MATERIAL.
4. DIMENSIONS A AND B DO NOT INCLUDE MOLD FLASH, PROTRUSIONS, OR GATE BURRS.
5. OPTIONAL CONSTRUCTION: AN ADDITIONAL TRIMMED LEAD IS ALLOWED IN THIS LOCATION. TRIMMED LEAD NOT TO EXTEND MORE THAN 0.2 FROM BODY.

DIM	MILLIMETERS	
	MIN	MAX
A	3.00 BSC	
B	1.50 BSC	
C	0.90	1.10
D	0.25	0.50
G	0.95 BSC	
H	0.01	0.10
J	0.10	0.26
K	0.20	0.60
L	1.25	1.55
M	0°	10°
S	2.50	3.00

SOLDERING FOOTPRINT*

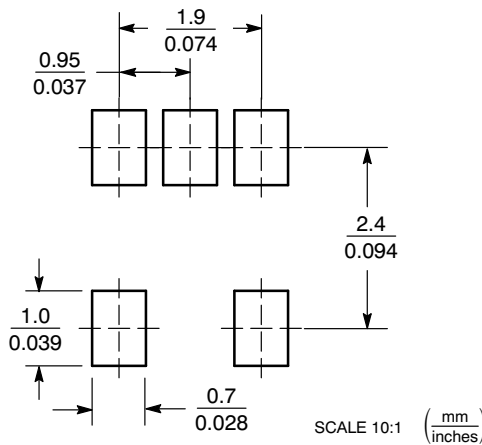

*For additional information on our Pb-Free strategy and soldering details, please download the ON Semiconductor Soldering and Mounting Techniques Reference Manual, SOLDERRM/D.

ON Semiconductor and are registered trademarks of Semiconductor Components Industries, LLC (SCILLC). SCILLC reserves the right to make changes without further notice to any products herein. SCILLC makes no warranty, representation or guarantee regarding the suitability of its products for any particular purpose, nor does SCILLC assume any liability arising out of the application or use of any product or circuit, and specifically disclaims any and all liability, including without limitation special, consequential or incidental damages. "Typical" parameters which may be provided in SCILLC data sheets and/or specifications can and do vary in different applications and actual performance may vary over time. All operating parameters, including "Typicals" must be validated for each customer application by customer's technical experts. SCILLC does not convey any license under its patent rights nor the rights of others. SCILLC products are not designed, intended, or authorized for use as components in systems intended for surgical implant into the body, or other applications intended to support or sustain life, or for any other application in which the failure of the SCILLC product could create a situation where personal injury or death may occur. Should Buyer purchase or use SCILLC products for any such unintended or unauthorized application, Buyer shall indemnify and hold SCILLC and its officers, employees, subsidiaries, affiliates, and distributors harmless against all claims, costs, damages, and expenses, and reasonable attorney fees arising out of, directly or indirectly, any claim of personal injury or death associated with such unintended or unauthorized use, even if such claim alleges that SCILLC was negligent regarding the design or manufacture of the part. SCILLC is an Equal Opportunity/Affirmative Action Employer. This literature is subject to all applicable copyright laws and is not for resale in any manner.

PUBLICATION ORDERING INFORMATION

LITERATURE FULFILLMENT:
Literature Distribution Center for ON Semiconductor
P.O. Box 5163, Denver, Colorado 80217 USA
Phone: 303-675-2175 or 800-344-3860 Toll Free USA/Canada
Fax: 303-675-2176 or 800-344-3867 Toll Free USA/Canada
Email: orderlit@onsemi.com

N. American Technical Support: 800-282-9855 Toll Free
USA/Canada
Europe, Middle East and Africa Technical Support:
Phone: 421 33 790 2910
Japan Customer Focus Center
Phone: 81-3-5773-3850

ON Semiconductor Website: www.onsemi.com
Order Literature: <http://www.onsemi.com/orderlit>
For additional information, please contact your local Sales Representative

AMEYA360

Components Supply Platform

Authorized Distribution Brand :



Website :

Welcome to visit www.ameya360.com

Contact Us :

➤ Address :

401 Building No.5, JiuGe Business Center, Lane 2301, Yishan Rd
Minhang District, Shanghai , China

➤ Sales :

Direct +86 (21) 6401-6692

Email amall@ameya360.com

QQ 800077892

Skype [ameyasales1](#) [ameyasales2](#)

➤ Customer Service :

Email service@ameya360.com

➤ Partnership :

Tel +86 (21) 64016692-8333

Email mkt@ameya360.com