

LM3241 6MHz, 750mA Miniature, Adjustable, Step-Down DC-DC Converter for RF Power Amplifiers

Check for Samples: [LM3241](#)

FEATURES

- 6MHz (typ.) PWM Switching Frequency
- Operates from a Single Li-Ion Cell (2.7V to 5.5V)
- Adjustable Output Voltage (0.6V to 3.4V)
- 750 mA Maximum Load Capability
- High Efficiency (95% typ. at 3.9V_{IN}, 3.3V_{OUT} at 500 mA)
- Automatic ECO/PWM mode change
- 6-bump DSBGA Package
- Current Overload Protection
- Thermal Overload Protection
- Soft Start Function
- C_{IN} and C_{OUT} are 0402 (1005) case size and 6.3V of rated-voltage ceramic capacitor
- Small Chip Inductor in 0805 (2012) case size

APPLICATIONS

- Battery-Powered 3G/4G Power Amplifiers
- Hand-Held Radios
- RF PC Cards
- Battery-Powered RF Devices

TYPICAL APPLICATION

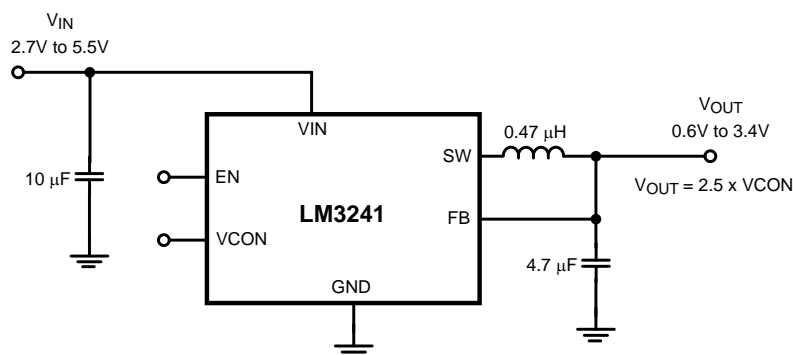

DESCRIPTION

The LM3241 is a DC-DC converter optimized for powering RF power amplifiers (PAs) from a single Lithium-Ion cell; however, it may be used in many other applications. It steps down an input voltage from 2.7V to 5.5V to an adjustable output voltage from 0.6V to 3.4V. Output voltage is set using a VCON analog input for controlling power levels and efficiency of the RF PA.

The LM3241 offers three modes of operation. In PWM mode the device operates at a fixed frequency of 6MHz (typ.) which minimizes RF interference when driving medium-to-heavy loads. At light load, the device enters into ECO mode automatically and operates with reduced switching frequency. In ECO mode, the quiescent current is reduced and extends the battery life. Shutdown mode turns the device off and reduces battery consumption to 0.1 µA (typ.).

The LM3241 is available in a 6-bump lead-free DSBGA package. A high-switching frequency (6MHz) allows use of tiny surface-mount components. Only three small external surface-mount components, an inductor and two ceramic capacitors are required.



Please be aware that an important notice concerning availability, standard warranty, and use in critical applications of Texas Instruments semiconductor products and disclaimers thereto appears at the end of this data sheet.

All trademarks are the property of their respective owners.



This integrated circuit can be damaged by ESD. Texas Instruments recommends that all integrated circuits be handled with appropriate precautions. Failure to observe proper handling and installation procedures can cause damage.

ESD damage can range from subtle performance degradation to complete device failure. Precision integrated circuits may be more susceptible to damage because very small parametric changes could cause the device not to meet its published specifications.

**Thin DSBGA Package, Large Bump (0.5 mm Pitch) (YZR06E1A)
6 Bumps**

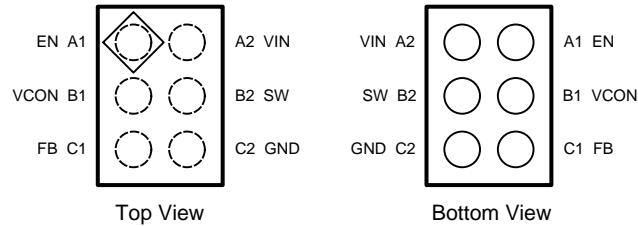

PIN DESCRIPTIONS

Pin #	Name	Description
A1	EN	Enable Input. Set this digital input high for normal operation. For shutdown, set low. Do not leave EN pin floating.
B1	VCON	Voltage Control Analog input. VCON controls VOUT in PWM mode. Do not leave VCON pin floating. $V_{OUT} = 2.5 \times VCON$.
C1	FB	Feedback Analog Input. Connect to the output at the output inductor.
C2	GND	Ground
B2	SW	Switching Node connection to the internal PFET switch and NFET synchronous rectifier. Connect to an inductor with a saturation current rating that exceeds the maximum Switch Peak Current Limit specification of the LM3241.
A2	VIN	Power supply input. Connect to the input filter capacitor (Typical Application Circuit).

ABSOLUTE MAXIMUM RATINGS (1) (2)

VIN to GND	-0.2V to +6.0V
EN, FB, VCON, SW	(GND-0.2V) to (VIN+0.2V) w/ 6.0V
Continuous Power Dissipation (3)	Internally Limited
Junction Temperature (T _{J-MAX})	+150°C
Storage Temperature Range	-65°C to +150°C
Maximum Lead Temperature (Soldering, 10 sec)	+260°C
ESD Rating (4) Human Body Model: Charged Device Model:	2kV 1250V

- (1) Stresses beyond those listed under *absolute maximum ratings* may cause permanent damage to the device. These are stress ratings only, and functional operation of the device at these or any other conditions beyond those indicated under *recommended operating conditions* is not implied. Exposure to absolute-maximum-rated conditions for extended periods may affect device reliability.
- (2) All voltages are with respect to the potential at the GND pins.
- (3) Internal thermal shutdown circuitry protects the device from permanent damage. Thermal shutdown engages at T_J = 150°C (typ.) and disengages at T_J = 125°C (typ.).
- (4) The Human body model is a 100 pF capacitor discharged through a 1.5 kΩ resistor into each pin. (MIL-STD-883 3015.7)

OPERATING RATINGS (1) (2)

Input Voltage Range	2.7V to 5.5V
Recommended Load Current	0mA to 750 mA
Junction Temperature (T _J) Range	-30°C to +125°C
Ambient Temperature (T _A) Range (3)	-30°C to +85°C

- (1) Stresses beyond those listed under *absolute maximum ratings* may cause permanent damage to the device. These are stress ratings only, and functional operation of the device at these or any other conditions beyond those indicated under *recommended operating conditions* is not implied. Exposure to absolute-maximum-rated conditions for extended periods may affect device reliability.
- (2) All voltages are with respect to the potential at the GND pins.
- (3) In applications where high power dissipation and/or poor package thermal resistance is present, the maximum ambient temperature may have to be de-rated. Maximum ambient temperature (T_{A-MAX}) is dependent on the maximum operating junction temperature (T_{J-MAX-OP} = 125°C), the maximum power dissipation of the device in the application (P_{D-MAX}), and the junction-to ambient thermal resistance of the part/package in the application (θ_{JA}), as given by the following equation: T_{A-MAX} = T_{J-MAX-OP} - (θ_{JA} × P_{D-MAX}).

THERMAL PROPERTIES

Junction-to-Ambient Thermal Resistance (θ _{JA}), YZR06 Package (1)	85°C/W
--	--------

- (1) Junction-to-ambient thermal resistance (θ_{JA}) is taken from a thermal modeling result, performed under the conditions and guidelines set forth in the JEDEC standard JESD51-7.

ELECTRICAL CHARACTERISTICS

PARAMETER		TEST CONDITIONS	MIN	TYP	MAX	UNIT
$V_{FB,MIN}$	Feedback voltage at minimum setting	PWM mode, $V_{CON} = 0.24V$	0.58	0.6	0.62	V
$V_{FB,MAX}$	Feedback voltage at maximum setting	PWM mode, $V_{CON} = 1.36V$, $V_{IN} = 3.9V$	3.332	3.4	3.468	
I_{SHDN}	Shutdown supply current	$EN = SW = V_{CON} = 0V$ (4)		0.1	2	μA
I_{Q_PWM}	PWM mode Quiescent current	PWM mode, No switching $V_{CON} = 0V$, $FB = 1V$ (5)		620	750	μA
I_{Q_ECO}	ECO mode Quiescent current	ECO mode, No switching $V_{CON} = 0.8V$, $FB = 2.05V$ (5)		45	60	
$R_{DSON(P)}$	Pin-pin resistance for PFET	$V_{IN} = V_{GS} = 3.6V$ $I_{SW} = 200\text{ mA}$		160	250	m Ω
$R_{DSON(N)}$	Pin-pin resistance for NFET	$V_{IN} = V_{GS} = 3.6V$ $I_{SW} = -200\text{ mA}$		110	200	
I_{LIM}	PFET switch peak current limit	(6)	1300	1450	1600	mA
F_{OSC}	Internal oscillator frequency		5.7	6	6.3	MHz
V_{IH}	EN Logic high input threshold		1.2			V
V_{IL}	EN Logic low input threshold				0.4	
Gain	V_{CON} to V_{OUT} gain	$0.24V \leq V_{CON} \leq 1.36V$		2.5		V/V
I_{CON}	V_{CON} pin leakage current	$V_{CON} = 1.0V$			± 1	μA

- (1) All voltages are with respect to the potential at the GND pins.
- (2) Min and Max limits are specified by design, test, or statistical analysis.
- (3) **The parameters in the electrical characteristics table are tested under open loop conditions at $V_{IN} = 3.6V$ unless otherwise specified. For performance over the input voltage range and closed-loop results, refer to the datasheet curves.**
- (4) Shutdown current includes leakage current of PFET.
- (5) I_Q specified here is when the part is not switching under test mode conditions. For operating quiescent current at no load, refer to datasheet curves.
- (6) Current limit is built-in, fixed, and not adjustable.

SYSTEM CHARACTERISTICS

The following spec table entries are guaranteed by design providing the component values in the Typical Application Circuit are used. **These parameters are not verified by production testing.** Min and Max values apply over the full operating ambient temperature range ($-30^{\circ}\text{C} \leq T_A \leq 85^{\circ}\text{C}$) and over the V_{IN} range = 2.7V to 5.5V unless otherwise specified. $L = 0.47 \mu\text{H}$, $\text{DCR} = 50 \text{ m}\Omega$, $C_{IN} = 10 \mu\text{F}$, 6.3V, 0603 (1608), $C_{OUT} = 4.7 \mu\text{F}$, 6.3V, 0603 (1608).

Sym bol	Parameter	Condition	Min	Typ	Max	Unit s
T _{CON} T _{TR}	V _{OUT} step rise time from 0.6V to 3.4V (to reach 3.26V)	V _{IN} = 3.6V, V _{CON} = 0.24V to 1.36V V _{CON} T _R = 1 μs , R _{LOAD} = 10 Ω			25	μs
	V _{OUT} step fall time from 3.4V to 0.6V (to reach 0.74V)	V _{IN} = 3.6V, V _{CON} = 1.36V to 0.24V V _{CON} T _F = 1 μs , R _{LOAD} = 10 Ω			25	
D	Maximum Duty cycle		100			%
I _{OUT}	Maximum output current capability	2.7V \leq V _{IN} \leq 5.5V 0.24V \leq V _{CON} \leq 1.36V	750			mA
C _{CON}	V _{CON} input capacitance	V _{CON} = 1V Test frequency = 100 KHz		5	10	pF
Line arity	Linearity in control range 0.24V to 1.36V	Monotonic in nature ⁽¹⁾	-3		+3	%
			-50		+50	mV
T _{ON}	Turn-on time (time for output to reach 95% final value after Enable low-to-high transition)	EN = Low-to-High V _{IN} = 4.2V, V _{OUT} = 3.4V I _{OUT} = < 1mA, C _{OUT} = 4.7 μF			50	μs
η	Efficiency	V _{IN} = 3.6V, V _{OUT} = 0.8V I _{OUT} = 10 mA, ECO mode		75		%
		V _{IN} = 3.6V, V _{OUT} = 1.8V I _{OUT} = 200 mA, PWM mode		90		
		V _{IN} = 3.9V, V _{OUT} = 3.3V I _{OUT} = 500 mA, PWM mode		95		
LINE T _{TR}	Line transient response	V _{IN} = 3.6V to 4.2V, T _R = T _F = 10 μs , I _{OUT} = 100 mA, V _{OUT} = 0.8V		50		mVp k
LOA D T _{TR}	Load transient response	V _{IN} = 3.1V/3.6V/4.5V, V _{OUT} = 0.8V, I _{OUT} = 50 mA to 150 mA T _R = T _F = 0.1 μs		50		

(1) Linearity limits are $\pm 3\%$ or $\pm 50 \text{ mV}$ whichever is larger.

BLOCK DIAGRAM

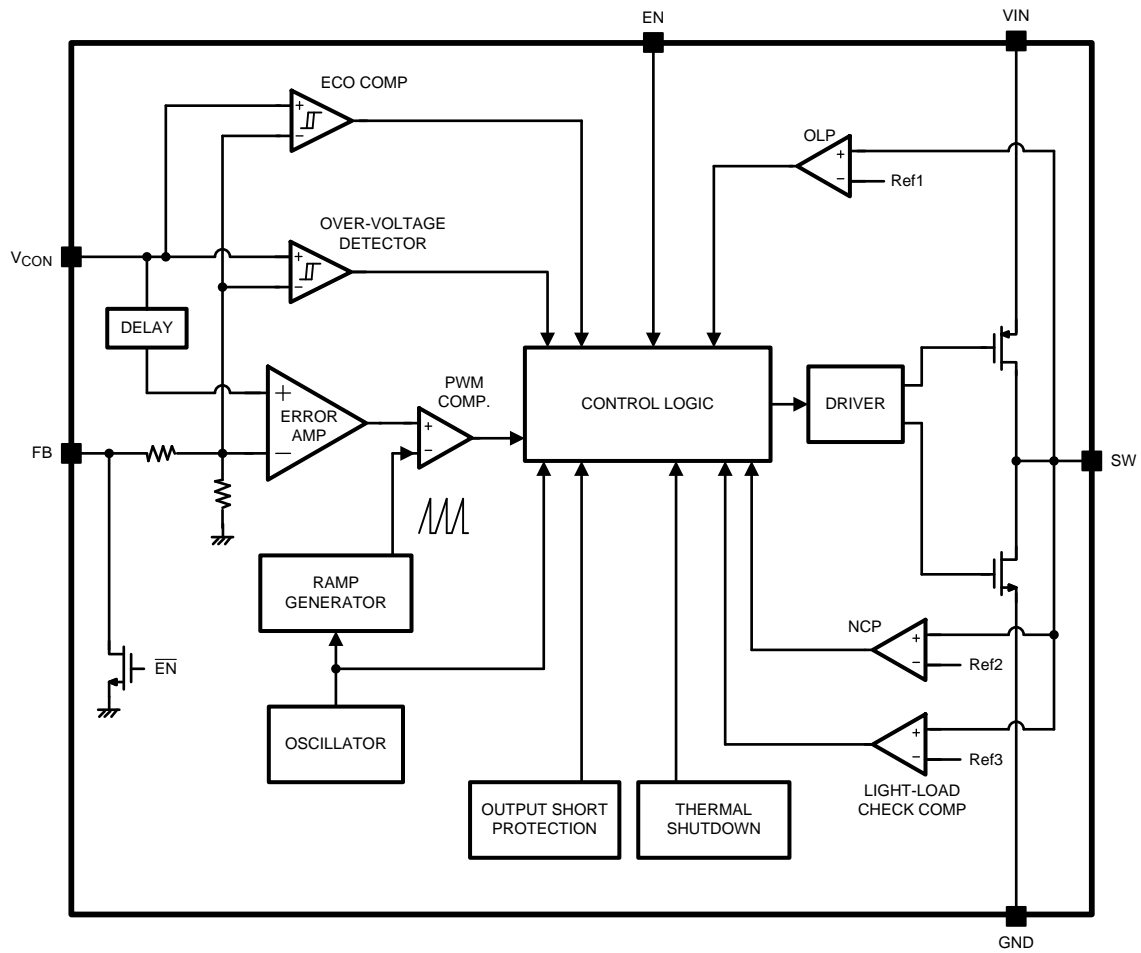

TYPICAL PERFORMANCE CHARACTERISTICS

$V_{IN} = E_N = 3.6V$ and $T_A = +25^\circ C$, unless otherwise noted.

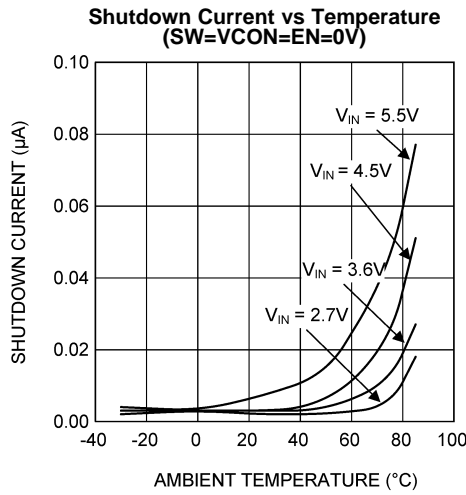

Figure 1.

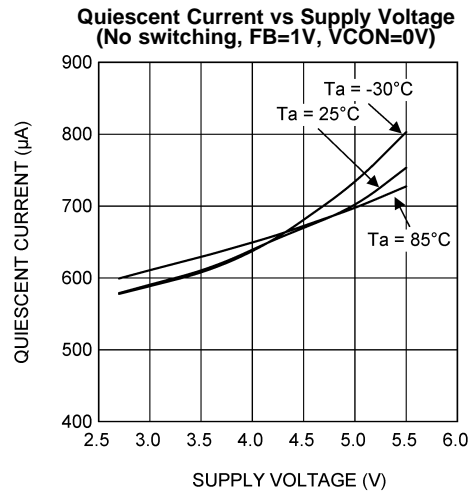

Figure 2.

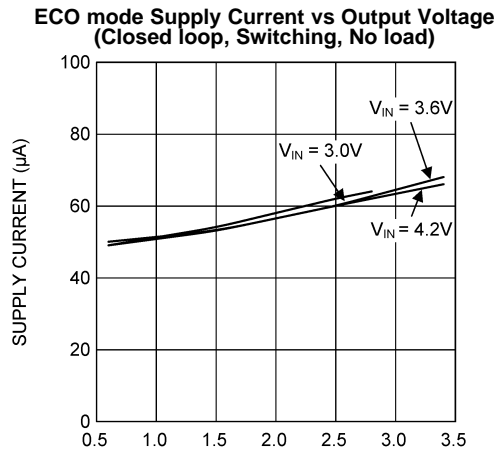

Figure 3.

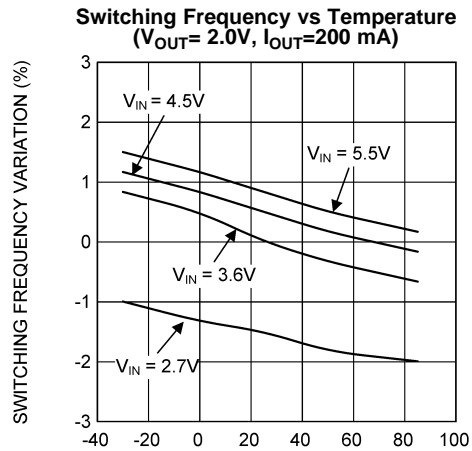

Figure 4.

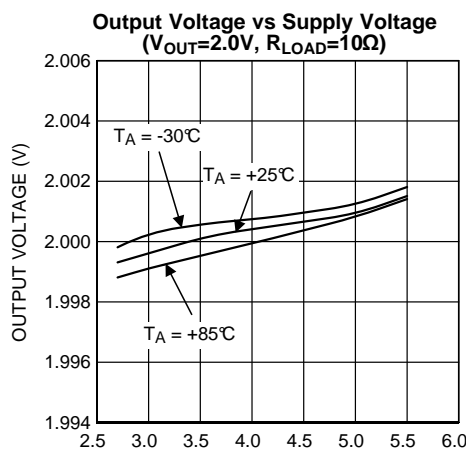

Figure 5.

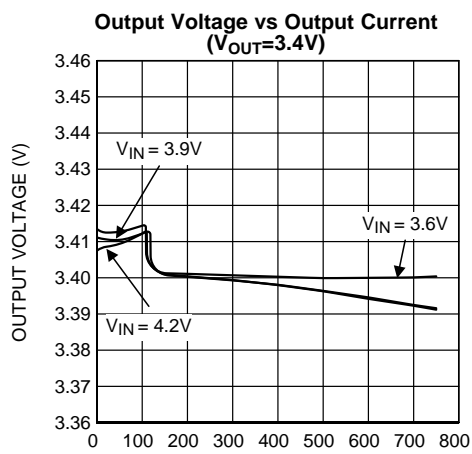

Figure 6.

TYPICAL PERFORMANCE CHARACTERISTICS (continued)

$V_{IN} = EN = 3.6V$ and $T_A = +25^{\circ}C$, unless otherwise noted.

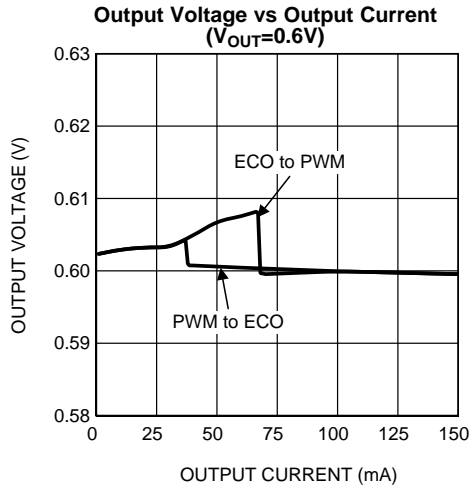

Figure 7.

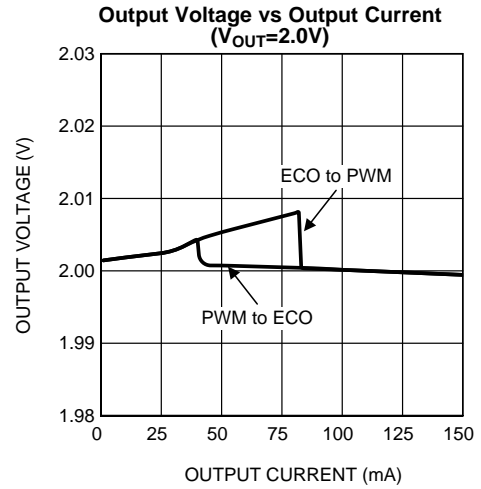

Figure 8.

ECO-PWM Mode Threshold Current vs Output voltage

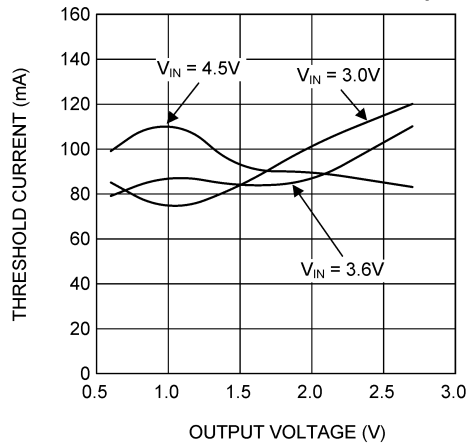

Figure 9.

PWM-ECO Mode Threshold Current vs Output voltage

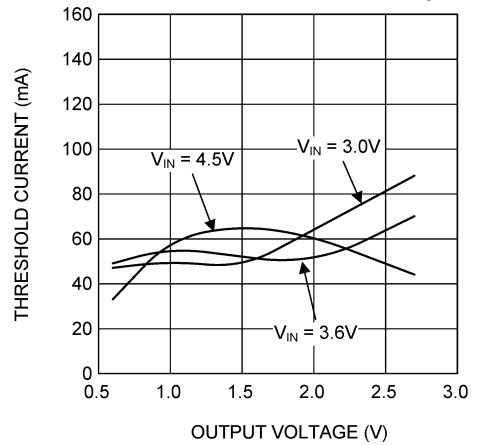

Figure 10.

Closed-loop Current Limit vs Temperature ($V_{OUT}= 2.0V$)

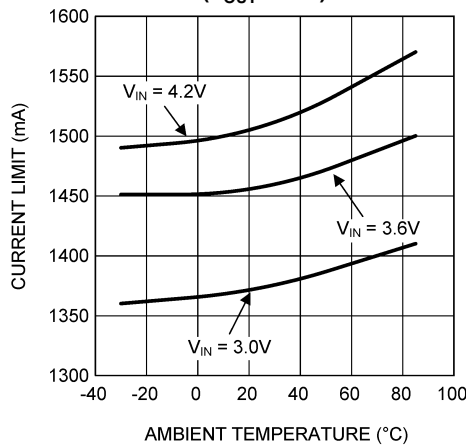

Figure 11.

Efficiency vs Output Current ($V_{OUT}=0.8V$)

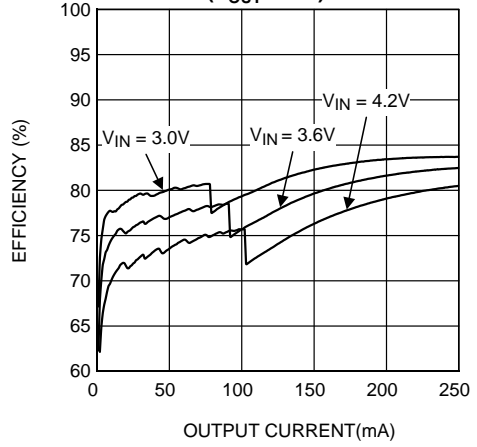

Figure 12.

TYPICAL PERFORMANCE CHARACTERISTICS (continued)

$V_{IN} = EN = 3.6V$ and $T_A = +25^\circ C$, unless otherwise noted.

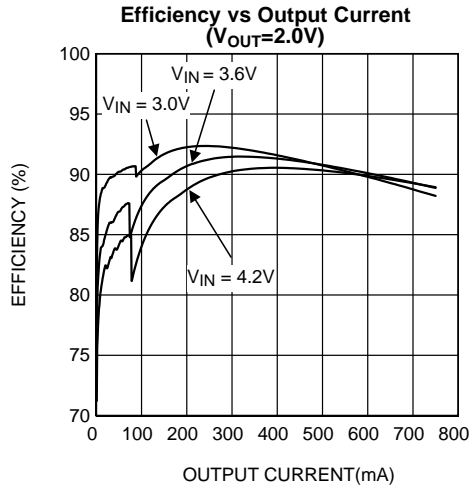

Figure 13.

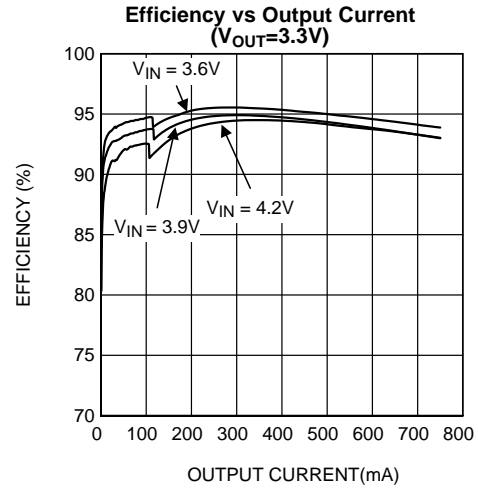

Figure 14.

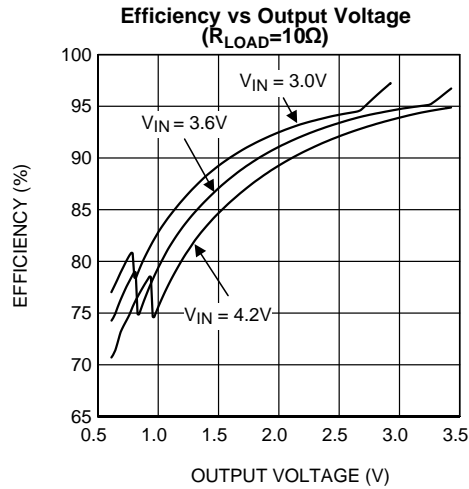

Figure 15.

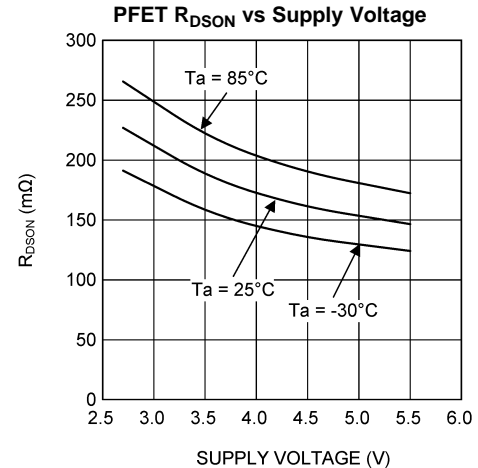

Figure 16.

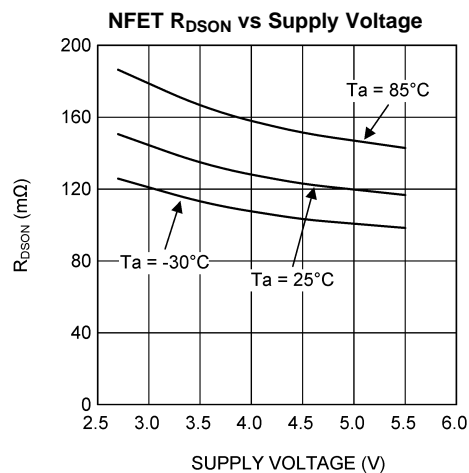

Figure 17.

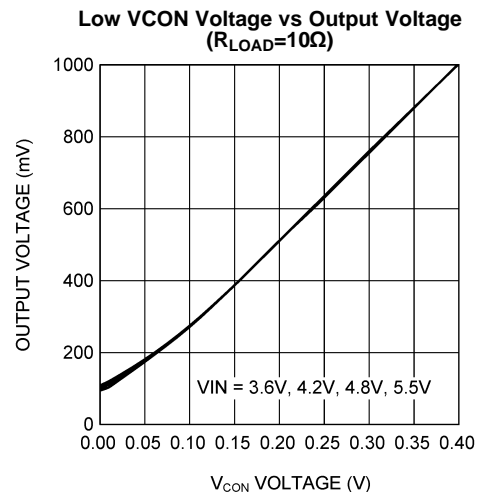
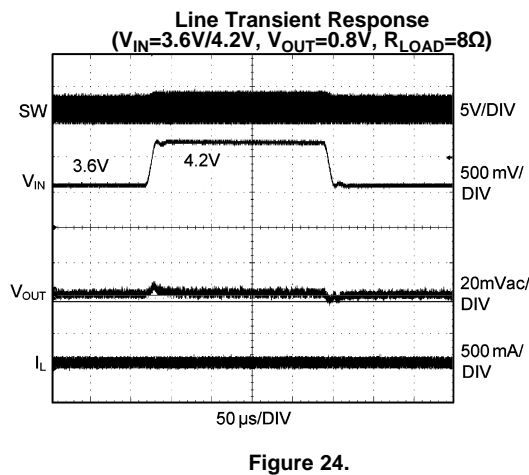
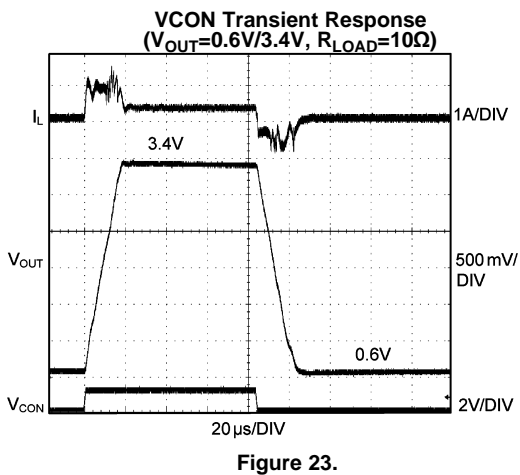
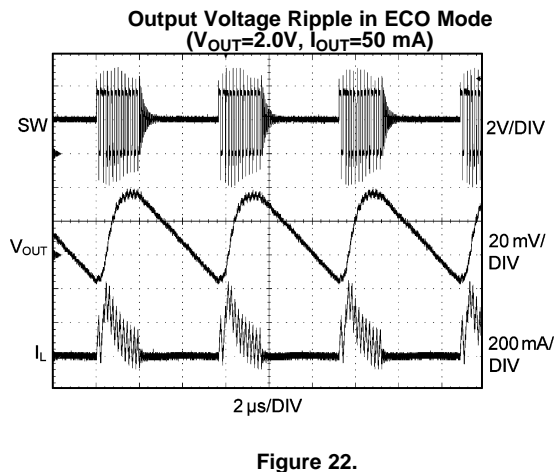
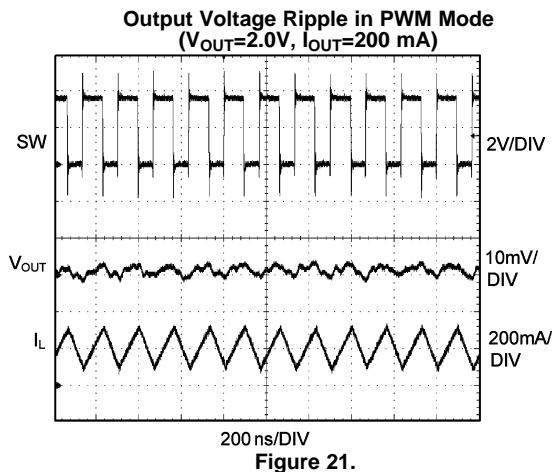
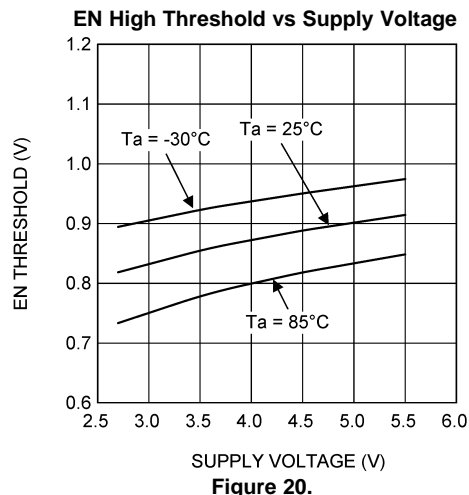
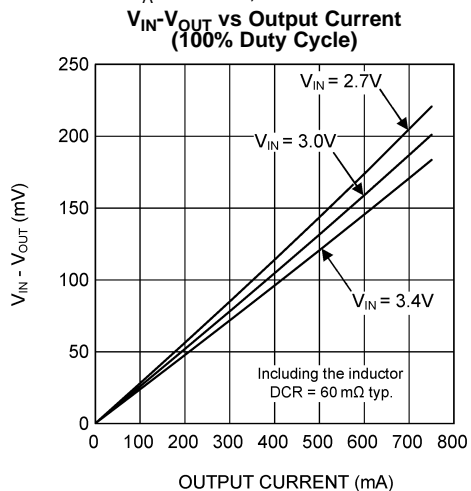

Figure 18.

TYPICAL PERFORMANCE CHARACTERISTICS (continued)

$V_{IN} = EN = 3.6V$ and $T_A = +25^\circ C$, unless otherwise noted.



TYPICAL PERFORMANCE CHARACTERISTICS (continued)

$V_{IN} = EN = 3.6V$ and $T_A = +25^{\circ}C$, unless otherwise noted.

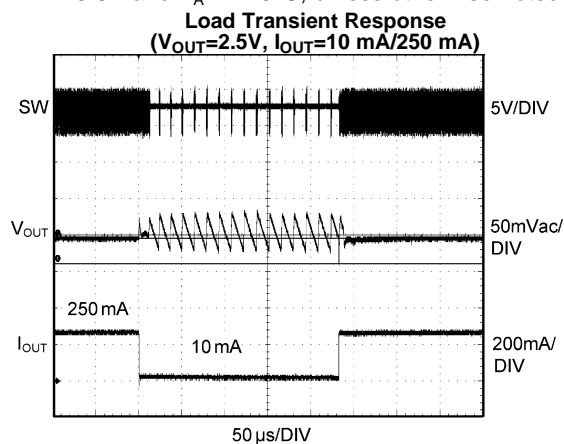

Figure 25.

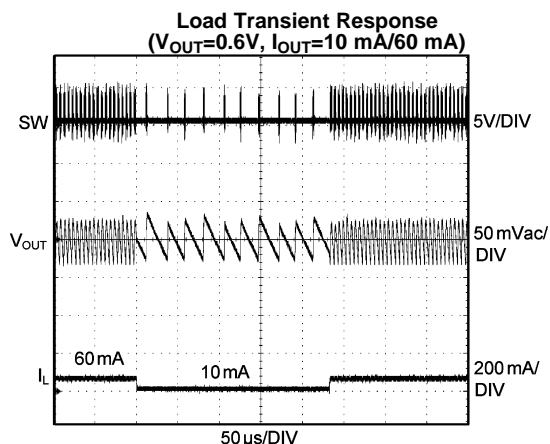

Figure 26.

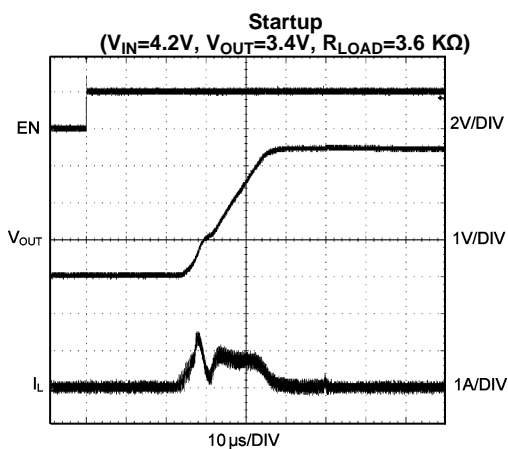

Figure 27.

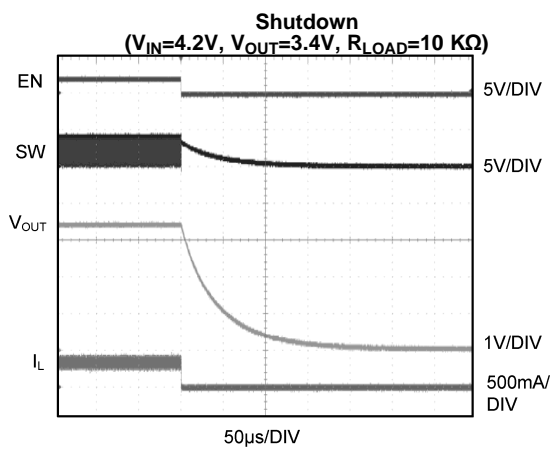

Figure 28.

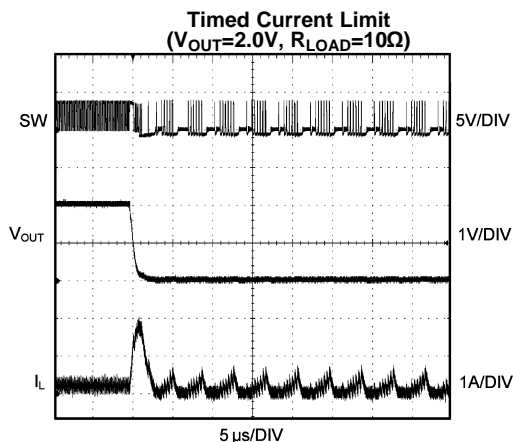

Figure 29.

FUNCTIONAL DESCRIPTION

Device Information

The LM3241 is a simple, step-down DC-DC converter optimized for powering RF power amplifiers (PAs) in mobile phones, portable communicators, and similar battery-powered RF devices. It is designed to allow the RF PA to operate at maximum efficiency over a wide range of power levels from a single Li-Ion battery cell. It is based on a voltage-mode buck architecture, with synchronous rectification for high efficiency. It is designed for a maximum load capability of 750 mA in PWM mode. Maximum load range may vary from this depending on input voltage, output voltage and the inductor chosen.

There are three modes of operation depending on the current required: PWM (Pulse Width Modulation), ECO (ECONomy), and shutdown. The LM3241 operates in PWM mode at higher load current conditions. Lighter loads cause the device to automatically switch into ECO mode. Shutdown mode turns the device off and reduces battery consumption to 0.1 μA (typ.).

DC PWM mode output voltage precision is $\pm 2\%$ for $3.4V_{\text{OUT}}$. Efficiency is typically around 95% (typ.) for a 500 mA load with 3.3V output, 3.9V input. The output voltage is dynamically programmable from 0.6V to 3.4V by adjusting the voltage on the control pin (VCON) without the need for external feedback resistors. This ensures longer battery life by being able to change the PA supply voltage dynamically depending on its transmitting power.

Additional features include current overload protection and thermal overload shutdown.

The LM3241 is constructed using a chip-scale 6-bump DSBGA package. This package offers the smallest possible size for space-critical applications, such as cell phones, where board area is an important design consideration. Use of a high switching frequency (6MHz, typ.) reduces the size of external components. As shown in the Typical Application Circuit, only three external power components are required for implementation. Use of a DSBGA package requires special design considerations for implementation. (See [DSBGA Package Assembly and Use](#) in the [APPLICATION INFORMATION](#) section.) Its fine-bump pitch requires careful board design and precision assembly equipment. Use of this package is best suited for opaque-case applications, where its edges are not subject to high-intensity ambient red or infrared light. Also, the system controller should set EN low during power-up and other low supply voltage conditions. (See [Shutdown Mode](#) below.)

Circuit Operation

Referring to the Typical Application Circuit and the [BLOCK DIAGRAM](#), the LM3241 operates as follows. During the first part of each switching cycle, the control block in the LM3241 turns on the internal top-side PFET switch. This allows current to flow from the input through the inductor to the output filter capacitor and load. The inductor limits the current to a ramp with a slope of around $(V_{\text{IN}} - V_{\text{OUT}}) / L$, by storing energy in a magnetic field. During the second part of each cycle, the controller turns the PFET switch off, blocking current flow from the input, and then turns the bottom-side NFET synchronous rectifier on. In response, the inductor's magnetic field collapses, generating a voltage that forces current from ground through the synchronous rectifier to the output filter capacitor and load. As the stored energy is transferred back into the circuit and depleted, the inductor current ramps down with a slope around V_{OUT} / L . The output filter capacitor stores charge when the inductor current is high, and releases it when low, smoothing the voltage across the load.

The output voltage is regulated by modulating the PFET switch on time to control the average current sent to the load. The effect is identical to sending a duty-cycle modulated rectangular wave formed by the switch and synchronous rectifier at SW to a low-pass filter formed by the inductor and output filter capacitor. The output voltage is equal to the average voltage at the SW pin.

PWM Mode Operation

While in PWM mode operation, the converter operates as a voltage-mode controller with input voltage feed forward. This allows the converter to achieve excellent load and line regulation. The DC gain of the power stage is proportional to the input voltage. To eliminate this dependence, feed forward inversely proportional to the input voltage is introduced. While in PWM mode, the output voltage is regulated by switching at a constant frequency and then modulating the energy per cycle to control power to the load. At the beginning of each clock cycle the PFET switch is turned on and the inductor current ramps up until the comparator trips and the control logic turns off the switch. The current limit comparator can also turn off the switch in case the current limit of the PFET is exceeded. Then the NFET switch is turned on and the inductor current ramps down. The next cycle is initiated by the clock turning off the NFET and turning on the PFET.

ECO Mode Operation

At very light loads (50 mA to 100 mA), the LM3241 enters ECO mode operation with reduced switching frequency and supply current to maintain high efficiency. During ECO mode operation, the LM3241 positions the output voltage slightly higher (+7mV typ.) than the normal output voltage during PWM mode operation, allowing additional headroom for voltage drop during a load transient from light to heavy load.

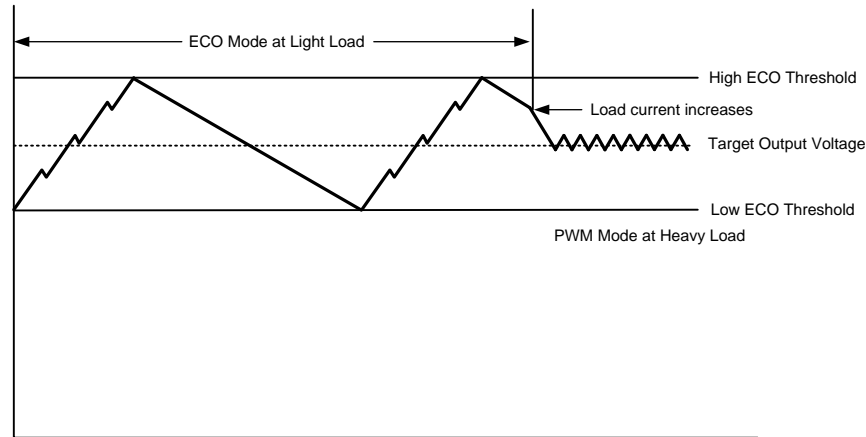

Figure 30. Operation in ECO Mode and Transfer to PWM Mode

Shutdown Mode

Setting the EN digital pin low (<0.4V) places the LM3241 in Shutdown mode (0.1 μ A typ.). During shutdown, the PFET switch, the NFET synchronous rectifier, reference voltage source, control and bias circuitry of the LM3241 are turned off. Setting EN high (>1.2V) enables normal operation. EN should be set low to turn off the LM3241 during power-up and undervoltage conditions when the power supply is less than the 2.7V minimum operating voltage. The LM3241 has an UVLO (Under Voltage Lock Out) comparator to turn the power device off in the case the input voltage or battery voltage is too low. The typical UVLO threshold is around 2.0V for lock and 2.1V for release.

Internal Synchronization Rectification

While in PWM mode, the LM3241 uses an internal NFET as a synchronous rectifier to reduce rectifier forward voltage drop and associated power loss. Synchronous rectification provides a significant improvement in efficiency whenever the output voltage is relatively low compared to the voltage drop across an ordinary rectifier diode.

With medium and heavy loads, the NFET synchronous rectifier is turned on during the inductor current down slope in the second part of each cycle. The synchronous rectifier is turned off prior to the next cycle. The NFET is designed to conduct through its intrinsic body diode during transient intervals before it turns on, eliminating the need for an external diode.

Current Limiting

The current limit feature allows the LM3241 to protect itself and external components during overload conditions. In PWM mode, the cycle-by-cycle current limit is 1450 mA (typ.). If an excessive load pulls the output voltage down to less than 0.3V (typ.), the NFET synchronous rectifier is disabled, and the current limit is reduced to 530 mA (typ.). Moreover, when the output voltage becomes less than 0.15V (typ.), the switching frequency will decrease to 3MHz, thereby preventing excess current and thermal stress.

Dynamically Adjustable Output Voltage

The LM3241 features dynamically adjustable output voltage to eliminate the need for external feedback resistors. The output can be set from 0.6V to 3.4V by changing the voltage on the analog VCON pin. This feature is useful in PA applications where peak power is needed only when the handset is far away from the base station or when data is being transmitted. In other instances the transmitting power can be reduced. Hence the supply voltage to the PA can be reduced, promoting longer battery life. See [Setting the Output Voltage](#) in the [APPLICATION INFORMATION](#) section for further details. The LM3241 moves into Pulse Skipping mode when duty cycle is over approximately 92% or less than approximately 15%, and the output voltage ripple increases slightly.

Thermal Overload Protection

The LM3241 has a thermal overload protection function that operates to protect itself from short-term misuse and overload conditions. When the junction temperature exceeds around 150°C, the device inhibits operation. Both the PFET and the NFET are turned off. When the temperature drops below 125°C, normal operation resumes. Prolonged operation in thermal overload conditions may damage the device and is considered bad practice.

Soft Start

The LM3241 has a soft-start circuit that limits in-rush current during startup. During startup the switch current limit is increased in steps. Soft start is activated if EN goes from low to high after V_{IN} reaches 2.7V.

APPLICATION INFORMATION

Setting the Output Voltage

The LM3241 features a pin-controlled adjustable output voltage to eliminate the need for external feedback resistors. It can be programmed for an output voltage from 0.6V to 3.4V by setting the voltage on the VCON pin, as in the following formula:

$$V_{OUT} = 2.5 \times VCON \quad (1)$$

When VCON is between 0.24V and 1.36V, the output voltage will follow proportionally by 2.5 times of VCON.

If VCON is less than 0.24V ($V_{OUT} = 0.6V$), the output voltage may be regulated. Refer to datasheet curve (Low VCON Voltage vs. Output Voltage) for details. This curve exhibits the characteristics of a typical part, and the performance cannot be guaranteed as there could be a part-to-part variation for output voltages less than 0.6V. For V_{OUT} lower than 0.6V, the converter might suffer from larger output ripple voltage and higher current limit operation.

Inductor Selection

There are two main considerations when choosing an inductor: the inductor should not saturate, and the inductor current ripple should be small enough to achieve the desired output voltage ripple. Different manufacturers follow different saturation current rating specifications, so attention must be given to details. Saturation current ratings are typically specified at 25°C so ratings over the ambient temperature of application should be requested from manufacturer.

Minimum value of inductance to guarantee good performance is 0.3 μ H at bias current (I_{LIM} (typ.)) over the ambient temperature range. Shielded inductors radiate less noise and should be preferred. There are two methods to choose the inductor saturation current rating.

Method 1:

The saturation current should be greater than the sum of the maximum load current and the worst case average to peak inductor current. This can be written as:

$$I_{SAT} > I_{OUT_MAX} + I_{RIPPLE}$$

where

$$I_{RIPPLE} = \left(\frac{V_{IN} - V_{OUT}}{2 \times L} \right) \times \left(\frac{V_{OUT}}{V_{IN}} \right) \times \left(\frac{1}{f} \right)$$

- I_{RIPPLE} : average-to-peak inductor current
- I_{OUT_MAX} : maximum load current (750 mA)
- V_{IN} : maximum input voltage in application
- L: minimum inductor value including worst-case tolerances (30% drop can be considered for Method 1)
- F: minimum switching frequency (5.7 MHz)
- V_{OUT} : output voltage

Method 2:

A more conservative and recommended approach is to choose an inductor that can handle the maximum current limit of 1600 mA.

The inductor's resistance should be less than around 0.1 Ω for good efficiency. [Table 1](#) lists suggested inductors and suppliers.

Table 1. Suggested Inductors

Model	Size (W x L x H) (mm)	Vendor
MIPSZ2012D0R5	2.0 x 1.2 x 1.0	FDK
LQM21PNR54MG0	2.0 x 1.25 x 0.9	Murata
LQM2MPNR47NG0	2.0 x 1.6 x 0.9	Murata

Capacitor Selection

The LM3241 is designed for use with ceramic capacitors for its input and output filters. Use a 10 μF ceramic capacitor for input and a 4.7 μF ceramic capacitor for output. They should maintain at least 50% capacitance at DC bias and temperature conditions. Ceramic capacitors type such as X5R, X7R, and B are recommended for both filters. They provide an optimal balance between small size, cost, reliability and performance for cell phones and similar applications. [Table 2](#) lists some suggested part numbers and suppliers. DC bias characteristics of the capacitors must be considered when selecting the voltage rating and case size of the capacitor. For C_{IN} , use of an 0805 (2012) size may also be considered if there is room on the system board.

Table 2. Suggested Capacitors

Capacitance, Voltage Rating, Case Size	Model	Vendor
4.7 μF , 6.3V, 0603	C1608X5R0J475M	TDK
4.7 μF , 6.3V, 0402	C1005X5R0J475M	TDK
4.7 μF , 6.3V, 0402	CL05A475MQ5NRNC	Samsung
10 μF , 6.3V, 0603	C1608X5R0J106M	TDK
10 μF , 6.3V, 0402	CL05A106MQ5NUNC	Samsung

The input filter capacitor supplies AC current drawn by the PFET switch of the LM3241 in the first part of each cycle and reduces the voltage ripple imposed on the input power source. The output filter capacitor absorbs the AC inductor current, helps maintain a steady output voltage during transient load changes, and reduces output voltage ripple. These capacitors must be selected with sufficient capacitance and sufficiently low ESR (Equivalent Series Resistance) to perform these functions. The ESR of the filter capacitors is generally a major factor in voltage ripple.

DSBGA Package Assembly and Use

Use of the DSBGA package requires specialized board layout, precision mounting and careful re-flow techniques, as detailed in Texas Instruments Application Note 1112. Refer to the section *Surface Mount Technology (SMD) Assembly Considerations*. For best results in assembly, alignment ordinals on the PC board should be used to facilitate placement of the device. The pad style used with DSBGA package must be the NSMD (non-solder mask defined) type. This means that the solder-mask opening is larger than the pad size. This prevents a lip that otherwise forms if the solder-mask and pad overlap when holding the device off the surface of the board causing interference with mounting. See Application Note 1112 for specific instructions how to do this.

The 6-bump package used for LM3241 has 300 micron solder balls and requires 10.82 mil pads for mounting on the circuit board. The trace to each pad should enter the pad with a 90° angle to prevent debris from being caught in deep corners. Initially, the trace to each pad should be 7 mil wide, for a section approximately 7 mil long, as a thermal relief. Then each trace should neck up or down to its optimal width. The important criterion is symmetry. This ensures the solder bumps on the LM3241 re-flow evenly and that the device solders level to the board. In particular, special attention must be paid to the pads for bumps A2 and C2. Because VIN and GND are typically connected to large copper planes, inadequate thermal relief can result in late or inadequate re-flow of these bumps.

The DSBGA package is optimized for the smallest possible size in applications with red or infrared opaque cases. Because the DSBGA package lacks the plastic encapsulation characteristic of larger devices, it is vulnerable to light. Backside metallization and/or epoxy coating, along with front-side shading by the printed circuit board, reduce this sensitivity. However, the package has exposed die edges. In particular, DSBGA devices are sensitive to light in the red and infrared range shining on the package's exposed die edges.

It is recommended that a 10 nF capacitor be added between VCON and ground for non-standard ESD events or environments and manufacturing processes. It prevents unexpected output voltage drift.

Board Layout Considerations

PC board layout is an important part of DC-DC converter design. Poor board layout can disrupt the performance of a DC-DC converter and surrounding circuitry by contributing to EMI, ground bounce, and resistive voltage loss in the traces. These can send erroneous signals to the DC-DC converter IC, resulting in poor regulation or instability. Poor layout can also result in re-flow problems leading to poor solder joints between the DSBGA package and board pads — poor solder joints can result in erratic or degraded performance. Good layout for the LM3241 can be implemented by following a few simple design rules, as illustrated in [Figure 31](#).

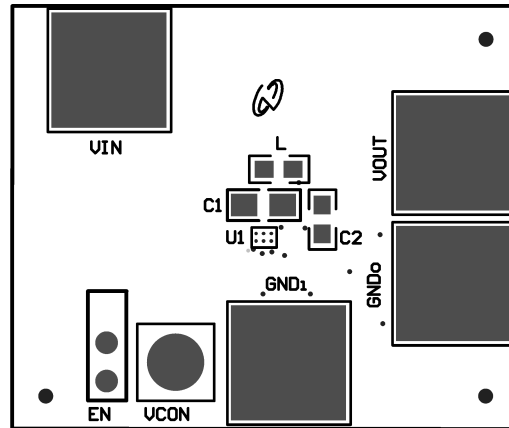
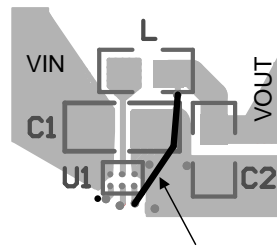

Figure 31. LM3241 Board Layout

1. Place the LM3241 on 10.82 mil pads. As a thermal relief, connect each pad with a 7mil wide, approximately 7mil long trace, and then incrementally increase each trace to its optimal width. V_{IN} and GND traces are especially recommended to be as wide as possible. The important criterion is symmetry to ensure the solder bumps re-flow evenly. (See AN-1112, *Surface Mount Technology (SMD) Assembly Considerations*.)
2. Place the LM3241, inductor, and filter capacitors close together and make the traces short. The traces between these components carry relatively high switching current and act as antennae. Following this rule reduces radiated noise. **Special care must be given to place the input filter capacitor very close to the V_{IN} and GND pads.**
3. Arrange the components so that the switching current loops curl in the same direction. During the first half of each cycle, current flows from the input filter capacitor, through the LM3241 and inductor to the output filter capacitor and back through ground, forming a current loop. In the second half of each cycle, current is pulled up from ground, through the LM3241 by the inductor, to the output filter capacitor and then back through ground, forming a second current loop. Routing these loops so the current curls in the same direction prevents magnetic field reversal between the two half-cycles and reduces radiated noise.
4. Connect the ground pads of the LM3241 and filter capacitors together using generous component-side copper fill as a pseudo-ground plane. Then connect this to the ground-plane (if one is used) with several vias. This reduces ground-plane noise by preventing the switching currents from circulating through the ground plane. It also reduces ground bounce at the LM3241 by giving it a low impedance ground connection.
5. Use side traces between the power components and for power connections to the DC-DC converter circuit. This reduces voltage errors caused by resistive losses across the traces.
6. Route noise sensitive traces such as the voltage feedback path away from noisy traces between the power components. The output voltage feedback point should be taken approximately 1.5 nH away from the output capacitor. The feedback trace also should be routed opposite to noise components. **The voltage feedback trace must remain close to the LM3241 circuit and should be routed directly from FB to VOUT at the inductor and should be routed opposite to noise components.** This allows fast feedback and reduces EMI radiated onto the DC-DC converter's own voltage feedback trace.



FB trace on another layer to be protected from noise.

- Place noise-sensitive circuitry, such as radio IF blocks, away from the DC-DC converter, CMOS digital blocks, and other noisy circuitry. Interference with noise-sensitive circuitry in the system can be reduced through distance.

In mobile phones, for example, a common practice is to place the DC-DC converter on one corner of the board, arrange the CMOS digital circuitry around it (since this also generates noise), and then place sensitive preamplifiers and IF stages on the diagonally opposing corner. Often, the sensitive circuitry is shielded with a metal pan and power to it is post-regulated to reduce conducted noise, using low-dropout linear regulators.

PACKAGING INFORMATION

Orderable Device	Status (1)	Package Type	Package Drawing	Pins	Package Qty	Eco Plan (2)	Lead/Ball Finish	MSL Peak Temp (3)	Op Temp (°C)	Device Marking (4/5)	Samples
LM3241TLE/NOPB	ACTIVE	DSBGA	YZR	6	250	Green (RoHS & no Sb/Br)	SNAGCU	Level-1-260C-UNLIM	-30 to 85	H	Samples
LM3241TLX/NOPB	ACTIVE	DSBGA	YZR	6	3000	Green (RoHS & no Sb/Br)	SNAGCU	Level-1-260C-UNLIM	-30 to 85	H	Samples

(1) The marketing status values are defined as follows:

ACTIVE: Product device recommended for new designs.

LIFEBUY: TI has announced that the device will be discontinued, and a lifetime-buy period is in effect.

NRND: Not recommended for new designs. Device is in production to support existing customers, but TI does not recommend using this part in a new design.

PREVIEW: Device has been announced but is not in production. Samples may or may not be available.

OBsolete: TI has discontinued the production of the device.

(2) Eco Plan - The planned eco-friendly classification: Pb-Free (RoHS), Pb-Free (RoHS Exempt), or Green (RoHS & no Sb/Br) - please check <http://www.ti.com/productcontent> for the latest availability information and additional product content details.

TBD: The Pb-Free/Green conversion plan has not been defined.

Pb-Free (RoHS): TI's terms "Lead-Free" or "Pb-Free" mean semiconductor products that are compatible with the current RoHS requirements for all 6 substances, including the requirement that lead not exceed 0.1% by weight in homogeneous materials. Where designed to be soldered at high temperatures, TI Pb-Free products are suitable for use in specified lead-free processes.

Pb-Free (RoHS Exempt): This component has a RoHS exemption for either 1) lead-based flip-chip solder bumps used between the die and package, or 2) lead-based die adhesive used between the die and leadframe. The component is otherwise considered Pb-Free (RoHS compatible) as defined above.

Green (RoHS & no Sb/Br): TI defines "Green" to mean Pb-Free (RoHS compatible), and free of Bromine (Br) and Antimony (Sb) based flame retardants (Br or Sb do not exceed 0.1% by weight in homogeneous material)

(3) MSL, Peak Temp. -- The Moisture Sensitivity Level rating according to the JEDEC industry standard classifications, and peak solder temperature.

(4) There may be additional marking, which relates to the logo, the lot trace code information, or the environmental category on the device.

(5) Multiple Device Markings will be inside parentheses. Only one Device Marking contained in parentheses and separated by a "~" will appear on a device. If a line is indented then it is a continuation of the previous line and the two combined represent the entire Device Marking for that device.

Important Information and Disclaimer: The information provided on this page represents TI's knowledge and belief as of the date that it is provided. TI bases its knowledge and belief on information provided by third parties, and makes no representation or warranty as to the accuracy of such information. Efforts are underway to better integrate information from third parties. TI has taken and continues to take reasonable steps to provide representative and accurate information but may not have conducted destructive testing or chemical analysis on incoming materials and chemicals. TI and TI suppliers consider certain information to be proprietary, and thus CAS numbers and other limited information may not be available for release.

In no event shall TI's liability arising out of such information exceed the total purchase price of the TI part(s) at issue in this document sold by TI to Customer on an annual basis.

TAPE AND REEL INFORMATION



QUADRANT ASSIGNMENTS FOR PIN 1 ORIENTATION IN TAPE



*All dimensions are nominal

Device	Package Type	Package Drawing	Pins	SPQ	Reel Diameter (mm)	Reel Width W1 (mm)	A0 (mm)	B0 (mm)	K0 (mm)	P1 (mm)	W (mm)	Pin1 Quadrant
LM3241TLE/NOPB	DSBGA	YZR	6	250	178.0	8.4	1.24	1.7	0.76	4.0	8.0	Q1
LM3241TLX/NOPB	DSBGA	YZR	6	3000	178.0	8.4	1.24	1.7	0.76	4.0	8.0	Q1

TAPE AND REEL BOX DIMENSIONS

*All dimensions are nominal

Device	Package Type	Package Drawing	Pins	SPQ	Length (mm)	Width (mm)	Height (mm)
LM3241TLE/NOPB	DSBGA	YZR	6	250	210.0	185.0	35.0
LM3241TLX/NOPB	DSBGA	YZR	6	3000	210.0	185.0	35.0

IMPORTANT NOTICE

Texas Instruments Incorporated and its subsidiaries (TI) reserve the right to make corrections, enhancements, improvements and other changes to its semiconductor products and services per JESD46, latest issue, and to discontinue any product or service per JESD48, latest issue. Buyers should obtain the latest relevant information before placing orders and should verify that such information is current and complete. All semiconductor products (also referred to herein as "components") are sold subject to TI's terms and conditions of sale supplied at the time of order acknowledgment.

TI warrants performance of its components to the specifications applicable at the time of sale, in accordance with the warranty in TI's terms and conditions of sale of semiconductor products. Testing and other quality control techniques are used to the extent TI deems necessary to support this warranty. Except where mandated by applicable law, testing of all parameters of each component is not necessarily performed.

TI assumes no liability for applications assistance or the design of Buyers' products. Buyers are responsible for their products and applications using TI components. To minimize the risks associated with Buyers' products and applications, Buyers should provide adequate design and operating safeguards.

TI does not warrant or represent that any license, either express or implied, is granted under any patent right, copyright, mask work right, or other intellectual property right relating to any combination, machine, or process in which TI components or services are used. Information published by TI regarding third-party products or services does not constitute a license to use such products or services or a warranty or endorsement thereof. Use of such information may require a license from a third party under the patents or other intellectual property of the third party, or a license from TI under the patents or other intellectual property of TI.

Reproduction of significant portions of TI information in TI data books or data sheets is permissible only if reproduction is without alteration and is accompanied by all associated warranties, conditions, limitations, and notices. TI is not responsible or liable for such altered documentation. Information of third parties may be subject to additional restrictions.

Resale of TI components or services with statements different from or beyond the parameters stated by TI for that component or service voids all express and any implied warranties for the associated TI component or service and is an unfair and deceptive business practice. TI is not responsible or liable for any such statements.

Buyer acknowledges and agrees that it is solely responsible for compliance with all legal, regulatory and safety-related requirements concerning its products, and any use of TI components in its applications, notwithstanding any applications-related information or support that may be provided by TI. Buyer represents and agrees that it has all the necessary expertise to create and implement safeguards which anticipate dangerous consequences of failures, monitor failures and their consequences, lessen the likelihood of failures that might cause harm and take appropriate remedial actions. Buyer will fully indemnify TI and its representatives against any damages arising out of the use of any TI components in safety-critical applications.

In some cases, TI components may be promoted specifically to facilitate safety-related applications. With such components, TI's goal is to help enable customers to design and create their own end-product solutions that meet applicable functional safety standards and requirements. Nonetheless, such components are subject to these terms.

No TI components are authorized for use in FDA Class III (or similar life-critical medical equipment) unless authorized officers of the parties have executed a special agreement specifically governing such use.

Only those TI components which TI has specifically designated as military grade or "enhanced plastic" are designed and intended for use in military/aerospace applications or environments. Buyer acknowledges and agrees that any military or aerospace use of TI components which have **not** been so designated is solely at the Buyer's risk, and that Buyer is solely responsible for compliance with all legal and regulatory requirements in connection with such use.

TI has specifically designated certain components as meeting ISO/TS16949 requirements, mainly for automotive use. In any case of use of non-designated products, TI will not be responsible for any failure to meet ISO/TS16949.

Products

Audio	www.ti.com/audio
Amplifiers	amplifier.ti.com
Data Converters	dataconverter.ti.com
DLP® Products	www.dlp.com
DSP	dsp.ti.com
Clocks and Timers	www.ti.com/clocks
Interface	interface.ti.com
Logic	logic.ti.com
Power Mgmt	power.ti.com
Microcontrollers	microcontroller.ti.com
RFID	www.ti-rfid.com
OMAP Applications Processors	www.ti.com/omap
Wireless Connectivity	www.ti.com/wirelessconnectivity

Applications

Automotive and Transportation	www.ti.com/automotive
Communications and Telecom	www.ti.com/communications
Computers and Peripherals	www.ti.com/computers
Consumer Electronics	www.ti.com/consumer-apps
Energy and Lighting	www.ti.com/energy
Industrial	www.ti.com/industrial
Medical	www.ti.com/medical
Security	www.ti.com/security
Space, Avionics and Defense	www.ti.com/space-avionics-defense
Video and Imaging	www.ti.com/video

TI E2E Community

e2e.ti.com

AMEYA360

Components Supply Platform

Authorized Distribution Brand :



Website :

Welcome to visit www.ameya360.com

Contact Us :

➤ Address :

401 Building No.5, JiuGe Business Center, Lane 2301, Yishan Rd
Minhang District, Shanghai , China

➤ Sales :

Direct +86 (21) 6401-6692

Email amall@ameya360.com

QQ 800077892

Skype [ameyasales1](#) [ameyasales2](#)

➤ Customer Service :

Email service@ameya360.com

➤ Partnership :

Tel +86 (21) 64016692-8333

Email mkt@ameya360.com