

FDT1600N10ALZ

N-Channel PowerTrench® MOSFET

100 V, 5.6 A, 160 mΩ

Features

- $R_{DS(on)} = 121 \text{ m}\Omega$ (Typ.) @ $V_{GS} = 10 \text{ V}$, $I_D = 2.8 \text{ A}$
- $R_{DS(on)} = 156 \text{ m}\Omega$ (Typ.) @ $V_{GS} = 5 \text{ V}$, $I_D = 1.8 \text{ A}$
- Low Gate Charge (Typ. 2.9 nC)
- Low C_{rss} (Typ. 2.04 pF)
- Fast Switching
- 100% Avalanche Tested
- Improved dv/dt Capability
- RoHS Compliant

Description

This N-Channel MOSFET is produced using Fairchild Semiconductor's advanced PowerTrench® process that has been tailored to minimize the on-state resistance and maintain superior switching performance.

Application

- Consumer Appliances
- LED TV and Monitor
- Synchronous Rectification
- Uninterruptible Power Supply
- Micro Solar Inverter

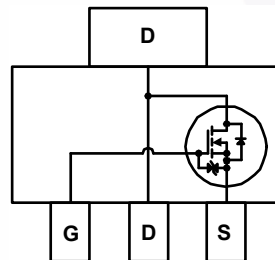
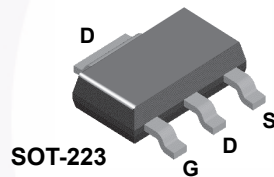

MOSFET Maximum Ratings $T_C = 25^\circ\text{C}$ unless otherwise noted.

| Symbol | Parameter | FDT1600N10ALZ | Unit |
|----------------|--|--|------------------|
| V_{DSS} | Drain to Source Voltage | 100 | V |
| V_{GSS} | Gate to Source Voltage | ± 20 | V |
| I_D | Drain Current | - Continuous ($T_C = 25^\circ\text{C}$) | 5.6 |
| | | - Continuous ($T_C = 100^\circ\text{C}$) | 3.5 |
| I_{DM} | Drain Current | - Pulsed (Note 2) | 11.2 |
| E_{AS} | Single Pulse Avalanche Energy | (Note 3) | 9.2 |
| dv/dt | Peak Diode Recovery dv/dt | (Note 4) | 6.0 |
| P_D | Power Dissipation | ($T_C = 25^\circ\text{C}$) | 10.42 |
| | | - Derate Above 25°C | 0.083 |
| T_J, T_{STG} | Operating and Storage Junction Temperature Range | -55 to +150 | $^\circ\text{C}$ |
| T_L | Maximum Lead Temperature for Soldering, 1/8" from Case for 5 Seconds | 300 | $^\circ\text{C}$ |

Thermal Characteristics

| | | | | |
|-----------------|---|-----------|----|---------------------------|
| $R_{\theta JC}$ | Thermal Resistance, Junction to Case, Max. | (Note 1) | 12 | $^\circ\text{C}/\text{W}$ |
| $R_{\theta JA}$ | Thermal Resistance, Junction to Ambient, Max. | (Note 1a) | 60 | |

Package Marking and Ordering Information

| Part Number | Top Mark | Package | Packing Method | Reel Size | Tape Width | Quantity |
|---------------|----------|---------|----------------|-----------|------------|------------|
| FDT1600N10ALZ | 16010ALZ | SOT-223 | Tape and Reel | 13" | 12 mm | 4000 units |

Electrical Characteristics $T_J = 25\text{ }^\circ\text{C}$ unless otherwise noted.

| Symbol | Parameter | Test Conditions | Min | Typ | Max | Unit |
|--------|-----------|-----------------|-----|-----|-----|------|
|--------|-----------|-----------------|-----|-----|-----|------|

Off Characteristics

| | | | | | | |
|--------------------------------|---|--|-----|-----|----------|---------------------|
| BV_{DSS} | Drain to Source Breakdown Voltage | $I_D = 250\text{ }\mu\text{A}$, $V_{GS} = 0\text{ V}$ | 100 | - | - | V |
| $\Delta BV_{DSS} / \Delta T_J$ | Breakdown Voltage Temperature Coefficient | $I_D = 250\text{ }\mu\text{A}$, referenced to $25\text{ }^\circ\text{C}$ | - | 0.1 | - | V/ $^\circ\text{C}$ |
| I_{DSS} | Zero Gate Voltage Drain Current | $V_{DS} = 80\text{ V}$, $V_{GS} = 0\text{ V}$ | - | - | 1 | μA |
| | | $V_{DS} = 80\text{ V}$, $V_{GS} = 0\text{ V}$, $T_C = 125\text{ }^\circ\text{C}$ | - | - | 500 | |
| I_{GSS} | Gate to Source Leakage Current | $V_{GS} = \pm 20\text{ V}$, $V_{DS} = 0\text{ V}$ | - | - | ± 10 | μA |

On Characteristics

| | | | | | | |
|--------------|--------------------------------------|--|-----|------|-----|------------------|
| $V_{GS(th)}$ | Gate Threshold Voltage | $V_{GS} = V_{DS}$, $I_D = 250\text{ }\mu\text{A}$ | 1.4 | - | 2.8 | V |
| $R_{DS(on)}$ | Static Drain to Source On Resistance | $V_{GS} = 10\text{ V}$, $I_D = 2.8\text{ A}$ | - | 121 | 160 | $\text{m}\Omega$ |
| | | $V_{GS} = 5\text{ V}$, $I_D = 1.8\text{ A}$ | - | 156 | 375 | $\text{m}\Omega$ |
| g_{FS} | Forward Transconductance | $V_{DS} = 10\text{ V}$, $I_D = 5.6\text{ A}$ | - | 26.1 | - | S |

Dynamic Characteristics

| | | | | | | |
|---------------|-----------------------------------|--|----------|------|------|-------------|
| C_{iss} | Input Capacitance | $V_{DS} = 50\text{ V}$, $V_{GS} = 0\text{ V}$, $f = 1\text{ MHz}$ | - | 169 | 225 | pF |
| C_{oss} | Output Capacitance | | - | 43 | 55 | pF |
| C_{rss} | Reverse Transfer Capacitance | | - | 2.04 | - | pF |
| $C_{oss(er)}$ | Energy Related Output Capacitance | $V_{DS} = 50\text{ V}$, $V_{GS} = 0\text{ V}$ | - | 85 | - | pF |
| $Q_{g(tot)}$ | Total Gate Charge at 10V | $V_{GS} = 10\text{ V}$ | - | 2.9 | 3.77 | nC |
| $Q_{g(tot)}$ | Total Gate Charge at 5V | $V_{GS} = 5\text{ V}$ | | | | |
| Q_{gs} | Gate to Source Gate Charge | $V_{DD} = 50\text{ V}$, $I_D = 5.6\text{ A}$ | - | 0.7 | - | nC |
| Q_{gd} | Gate to Drain "Miller" Charge | | - | 0.64 | - | nC |
| $V_{plateau}$ | Gate Plateau Voltage | | (Note 5) | - | 3.81 | - |
| Q_{sync} | Total Gate Charge Sync. | $V_{DS} = 0\text{ V}$, $I_D = 2.8\text{ A}$ | - | 2.45 | - | nC |
| Q_{oss} | Output Charge | $V_{DS} = 50\text{ V}$, $V_{GS} = 0\text{ V}$ | - | 5.2 | - | nC |
| ESR | Equivalent Series Resistance(G-S) | $f = 1\text{ MHz}$ | - | 2.1 | - | Ω |

Switching Characteristics

| | | | | | | |
|--------------|---------------------|---|----------|------|------|------|
| $t_{d(on)}$ | Turn-On Delay Time | $V_{DD} = 50\text{ V}$, $I_D = 5.6\text{ A}$, $V_{GS} = 10\text{ V}$, $R_G = 4.7\text{ }\Omega$ | - | 7.4 | 24.8 | ns |
| t_r | Rise Time | | - | 2.5 | 15 | ns |
| $t_{d(off)}$ | Turn-Off Delay Time | | - | 13.5 | 37 | ns |
| t_f | Turn-Off Fall Time | | (Note 5) | - | 2.4 | 14.8 |

Drain-Source Diode Characteristics

| | | | | | | |
|----------|--|--|---|------|-----|-------------|
| I_S | Maximum Continuous Drain to Source Diode Forward Current | - | - | 5.6 | A | |
| I_{SM} | Maximum Pulsed Drain to Source Diode Forward Current | - | - | 11.2 | A | |
| V_{SD} | Source to Drain Diode Forward Voltage | $V_{GS} = 0\text{ V}$, $I_{SD} = 5.6\text{ A}$ | - | - | 1.3 | V |
| t_{rr} | Reverse Recovery Time | $V_{GS} = 0\text{ V}$, $I_{SD} = 5.6\text{ A}$, $V_{DD} = 50\text{ V}$, $di_F/dt = 100\text{ A}/\mu\text{s}$ | - | 34.1 | - | ns |
| Q_{rr} | Reverse Recovery Charge | | - | 32.7 | - | nC |

NOTES:

- $R_{\theta JA}$ is the sum of the junction-to-case and case-to-ambient thermal resistance where the case thermal reference is defined as the solder mounting surface of the drain pins. $R_{\theta JC}$ is guaranteed by design while $R_{\theta CA}$ is determined by the user's board design.



a) $60\text{ }^\circ\text{C/W}$ when mounted on a 1 in^2 pad of 2-oz copper.



b) $118\text{ }^\circ\text{C/W}$ when mounted on a minimum pad of 2 oz copper.

- Repetitive rating: pulse-width limited by maximum junction temperature.
- Starting $T_J = 25\text{ }^\circ\text{C}$, $L = 3\text{ mH}$, $I_{AS} = 2.47\text{ A}$.
- $I_{SD} \leq 5.6\text{ A}$, $di/dt \leq 200\text{ A}/\mu\text{s}$, $V_{DD} \leq BV_{DSS}$, starting $T_J = 25\text{ }^\circ\text{C}$.
- Essentially independent of operating temperature typical characteristics.

Typical Performance Characteristics

Figure 1. On-Region Characteristics

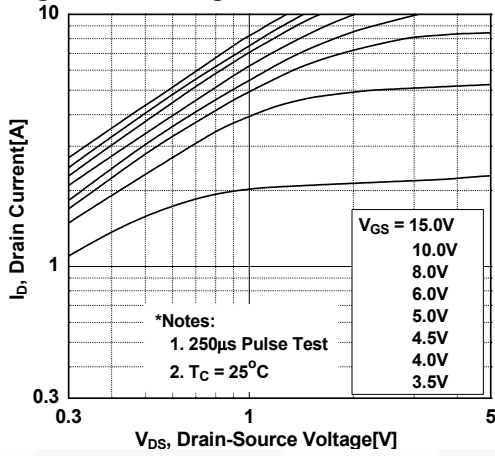

Figure 2. Transfer Characteristics

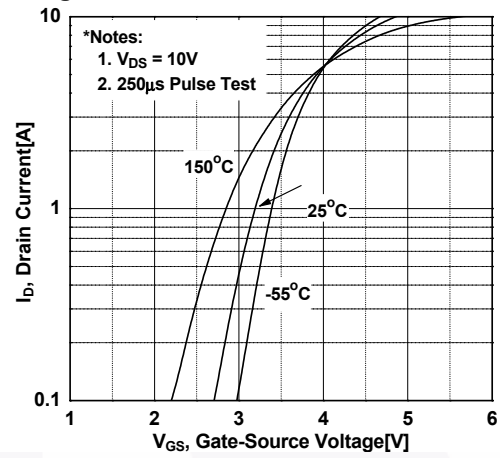

Figure 3. On-Resistance Variation vs. Drain Current and Gate Voltage

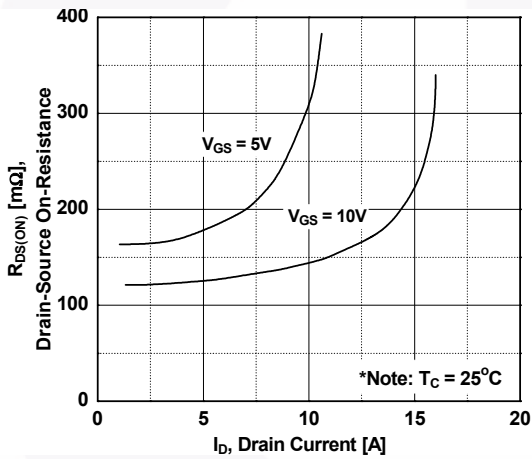

Figure 4. Body Diode Forward Voltage Variation vs. Source Current and Temperature

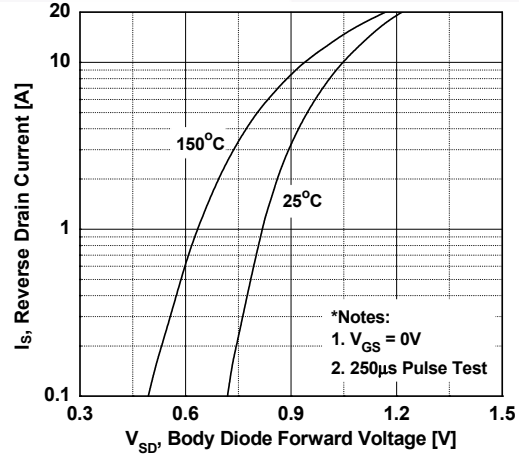

Figure 5. Capacitance Characteristics

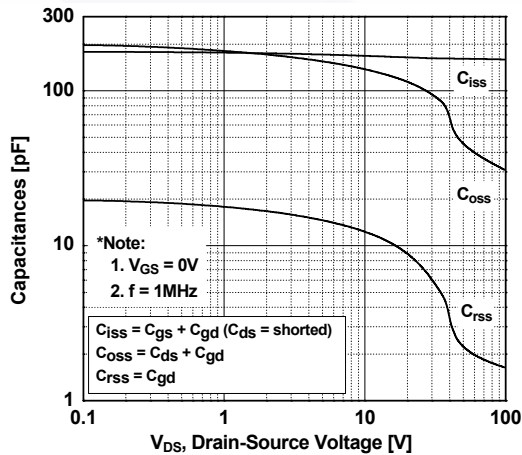
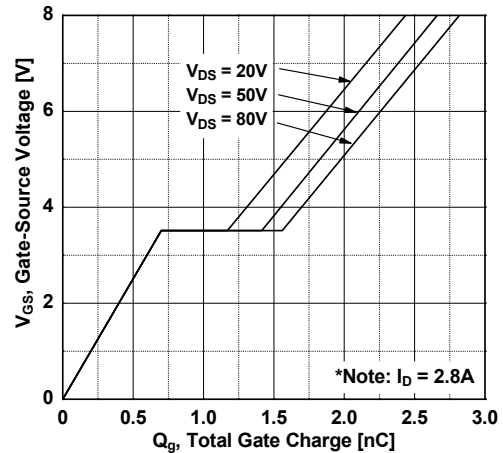

Figure 6. Gate Charge Characteristics



Typical Performance Characteristics (Continued)

Figure 7. Breakdown Voltage Variation vs. Temperature

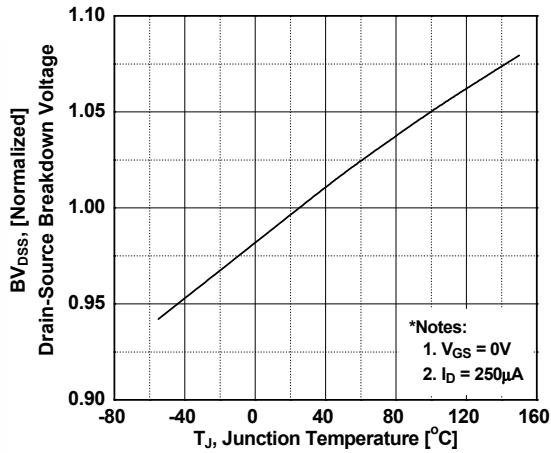

Figure 8. On-Resistance Variation vs. Temperature

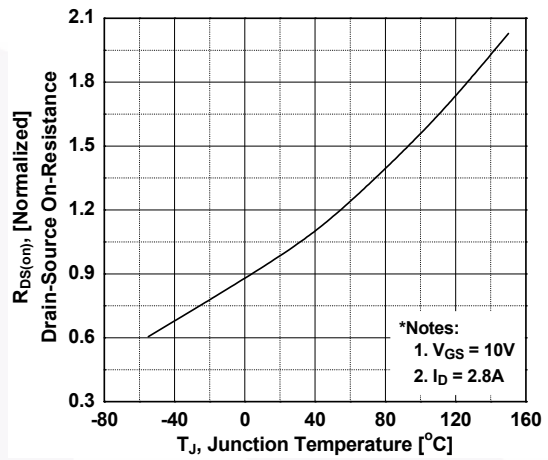

Figure 9. Maximum Safe Operating Area

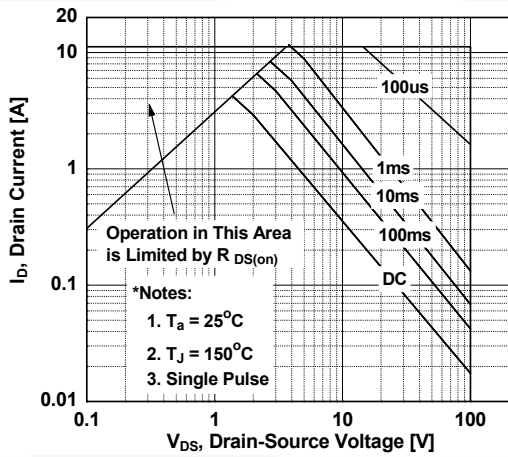

Figure 10. Maximum Drain Current vs. Case Temperature

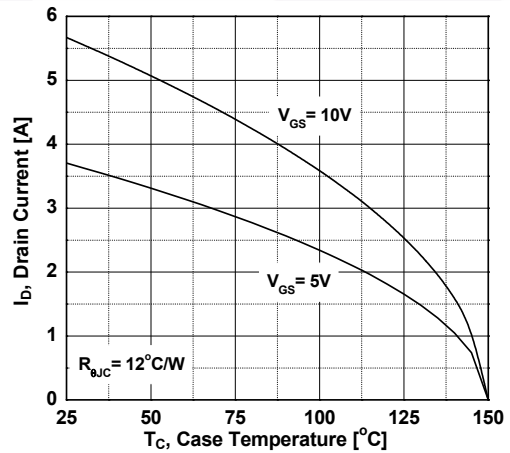

Figure 11. E_oss vs. Drain to Source Voltage

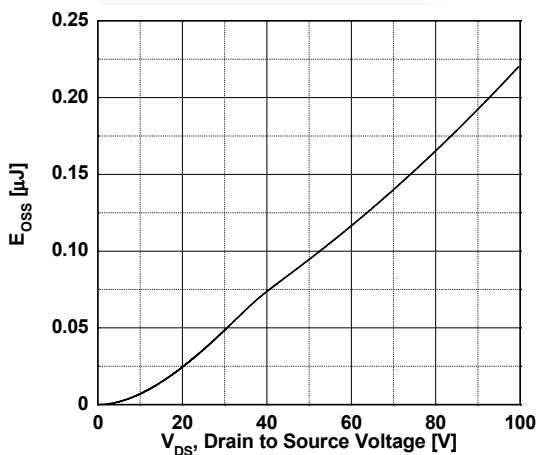
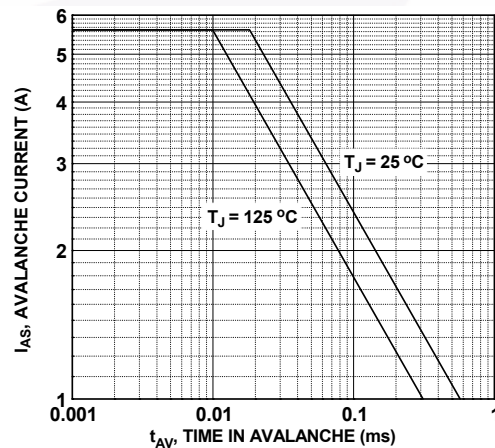

Figure 12. Unclamped Inductive Switching Capability



Typical Performance Characteristics (Continued)

Figure 13. Transient Thermal Response Curve

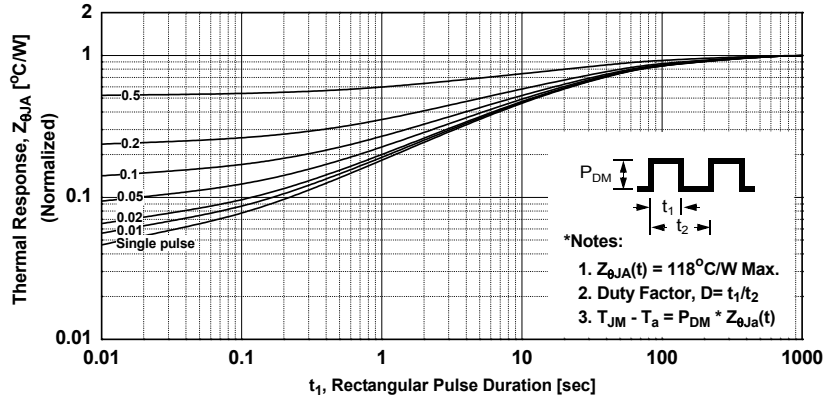



Figure 14. Gate Charge Test Circuit & Waveform



Figure 15. Resistive Switching Test Circuit & Waveforms



Figure 16. Unclamped Inductive Switching Test Circuit & Waveforms



Figure 17. Peak Diode Recovery dv/dt Test Circuit & Waveforms

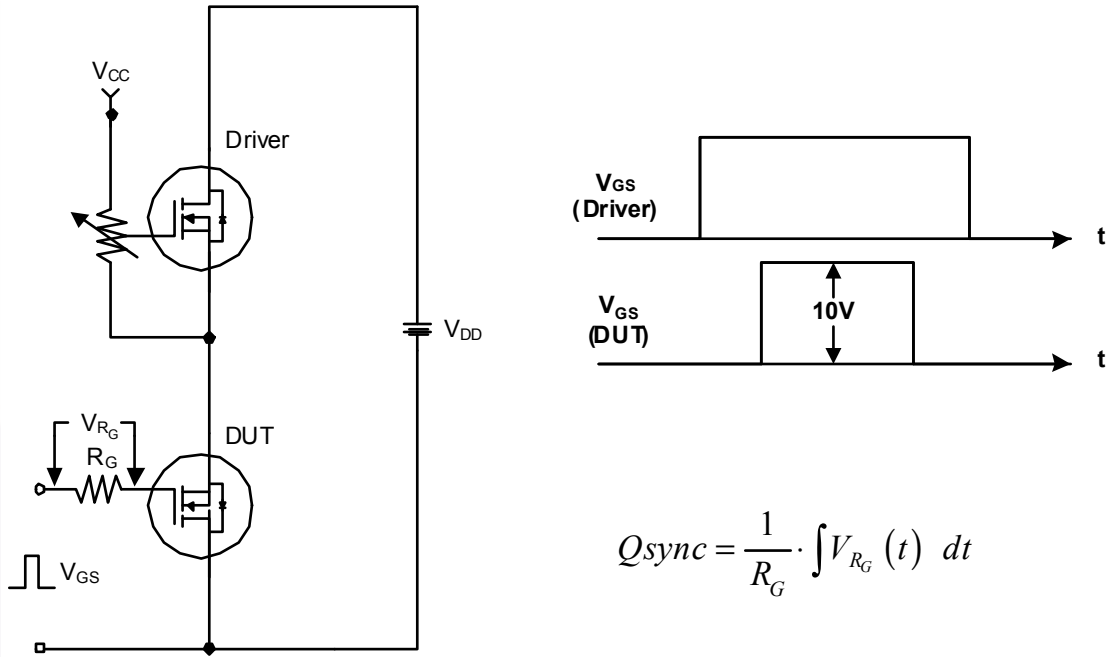

Figure 18. Total Gate Charge Q_{sync} . Test Circuit & Waveforms

Mechanical Dimensions

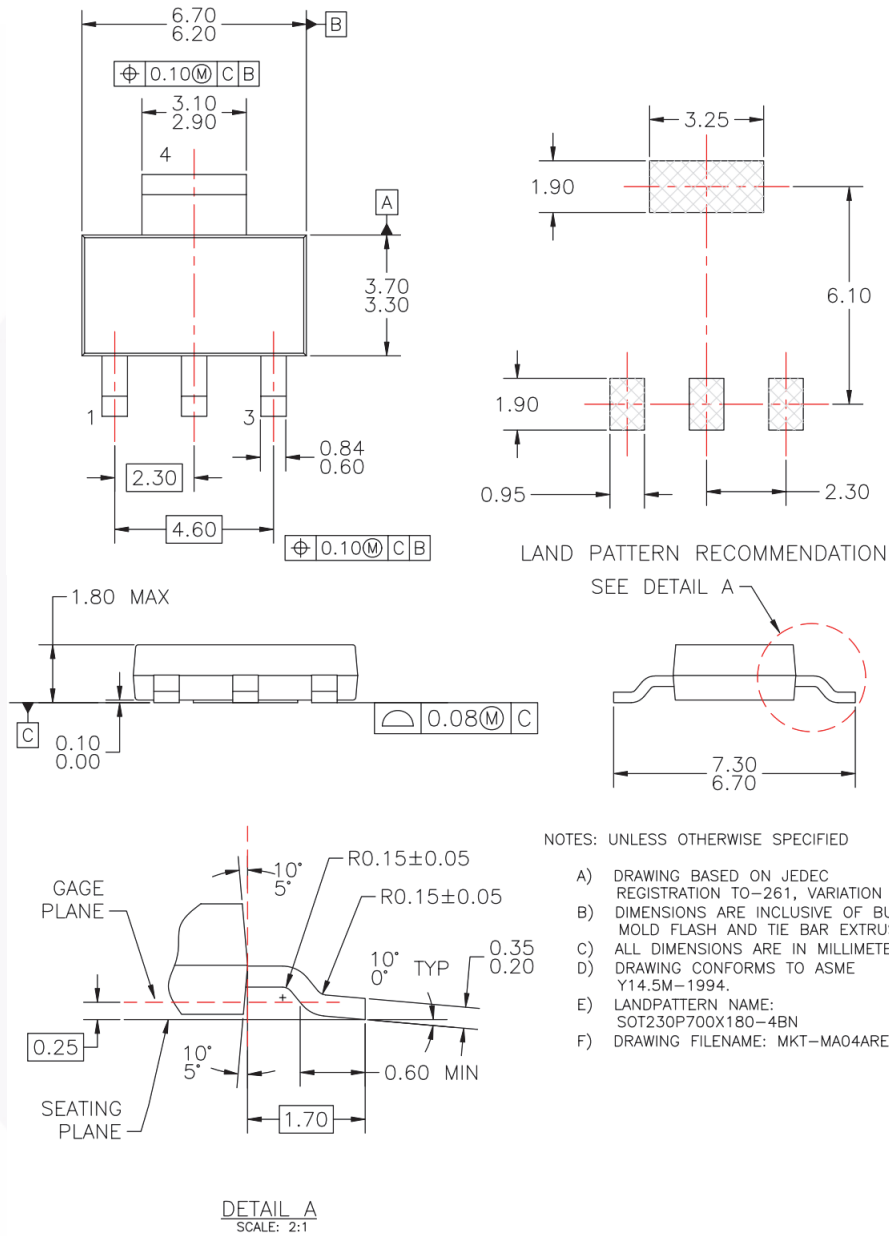

Figure 19. SOT-223, Molded, 4-Lead

Package drawings are provided as a service to customers considering Fairchild components. Drawings may change in any manner without notice. Please note the revision and/or date on the drawing and contact a Fairchild Semiconductor representative to verify or obtain the most recent revision. Package specifications do not expand the terms of Fairchild's worldwide terms and conditions, specifically the warranty therein, which covers Fairchild products.

Always visit Fairchild Semiconductor's online packaging area for the most recent package drawings:

http://www.fairchildsemi.com/package/packageDetails.html?id=PN_TTE23-C04



TRADEMARKS

The following includes registered and unregistered trademarks and service marks, owned by Fairchild Semiconductor and/or its global subsidiaries, and is not intended to be an exhaustive list of all such trademarks.

- | | | | |
|--------------------------|-------------------------|---|------------------|
| AccuPower™ | F-PFS™ | PowerTrench® | Sync-Lock™ |
| AX-CAP®* | FRFET® | PowerXS™ | SYSTEM GENERAL®* |
| BitSiC™ | Global Power ResourceSM | Programmable Active Droop™ | TinyBoost® |
| Build it Now™ | GreenBridge™ | QFET® | TinyBuck® |
| CorePLUS™ | Green FPS™ | QS™ | TinyCalc™ |
| CorePOWER™ | Green FPS™ e-Series™ | Quiet Series™ | TinyLogic® |
| CROSSVOLT™ | Gmax™ | RapidConfigure™ | TINYOPTO™ |
| CTL™ | GTO™ | ISOPLANAR™ | TinyPower™ |
| Current Transfer Logic™ | IntelliMAX™ | Marking Small Speakers Sound Louder and Better™ | TinyPWM™ |
| DEUXPEED® | ISOPLANAR™ | MegaBuck™ | TinyWire™ |
| Dual Cool™ | MICROCOUPLER™ | MicroFET™ | TranSiC™ |
| EcoSPARK® | MicroPak™ | MillerDrive™ | TriFault Detect™ |
| EfficientMax™ | MicroPak2™ | MotionMax™ | TRUECURRENT®* |
| ESBC™ | MicroPak2™ | mWSaver® | µSerDes™ |
| F ® | MillerDrive™ | OptoHiT™ | UHC® |
| Fairchild® | MotionMax™ | OPTOLOGIC® | Ultra FRFET™ |
| Fairchild Semiconductor® | OPTOPLANAR® | OPTOLOGIC® | UniFET™ |
| FACT Quiet Series™ | OPTOPLANAR® | OPTOLOGIC® | VCX™ |
| FACT® | OPTOPLANAR® | OPTOLOGIC® | VisualMax™ |
| FAST® | OPTOPLANAR® | OPTOLOGIC® | VoltagePlus™ |
| FastvCore™ | OPTOPLANAR® | OPTOLOGIC® | XS™ |
| FETBench™ | OPTOPLANAR® | OPTOLOGIC® | |
| FPS™ | OPTOPLANAR® | OPTOLOGIC® | |
| | | Saving our world, 1mW/W/kW at a time™ | |
| | | SignalWise™ | |
| | | SmartMax™ | |
| | | SMART START™ | |
| | | Solutions for Your Success™ | |
| | | SPM® | |
| | | STEALTH™ | |
| | | SuperFET® | |
| | | SuperSOT™-3 | |
| | | SuperSOT™-6 | |
| | | SuperSOT™-8 | |
| | | SupreMOS® | |
| | | SyncFET™ | |

*Trademarks of System General Corporation, used under license by Fairchild Semiconductor.

DISCLAIMER

FAIRCHILD SEMICONDUCTOR RESERVES THE RIGHT TO MAKE CHANGES WITHOUT FURTHER NOTICE TO ANY PRODUCTS HEREIN TO IMPROVE RELIABILITY, FUNCTION, OR DESIGN. FAIRCHILD DOES NOT ASSUME ANY LIABILITY ARISING OUT OF THE APPLICATION OR USE OF ANY PRODUCT OR CIRCUIT DESCRIBED HEREIN; NEITHER DOES IT CONVEY ANY LICENSE UNDER ITS PATENT RIGHTS, NOR THE RIGHTS OF OTHERS. THESE SPECIFICATIONS DO NOT EXPAND THE TERMS OF FAIRCHILD'S WORLDWIDE TERMS AND CONDITIONS, SPECIFICALLY THE WARRANTY THEREIN, WHICH COVERS THESE PRODUCTS.

LIFE SUPPORT POLICY

FAIRCHILD'S PRODUCTS ARE NOT AUTHORIZED FOR USE AS CRITICAL COMPONENTS IN LIFE SUPPORT DEVICES OR SYSTEMS WITHOUT THE EXPRESS WRITTEN APPROVAL OF FAIRCHILD SEMICONDUCTOR CORPORATION.

As used here in:

- Life support devices or systems are devices or systems which, (a) are intended for surgical implant into the body or (b) support or sustain life, and (c) whose failure to perform when properly used in accordance with instructions for use provided in the labeling, can be reasonably expected to result in a significant injury of the user.
- A critical component in any component of a life support, device, or system whose failure to perform can be reasonably expected to cause the failure of the life support device or system, or to affect its safety or effectiveness.

ANTI-COUNTERFEITING POLICY

Fairchild Semiconductor Corporation's Anti-Counterfeiting Policy. Fairchild's Anti-Counterfeiting Policy is also stated on our external website, www.Fairchildsemi.com, under Sales Support. Counterfeiting of semiconductor parts is a growing problem in the industry. All manufactures of semiconductor products are experiencing counterfeiting of their parts. Customers who inadvertently purchase counterfeit parts experience many problems such as loss of brand reputation, substandard performance, failed application, and increased cost of production and manufacturing delays. Fairchild is taking strong measures to protect ourselves and our customers from the proliferation of counterfeit parts. Fairchild strongly encourages customers to purchase Fairchild parts either directly from Fairchild or from Authorized Fairchild Distributors who are listed by country on our web page cited above. Products customers buy either from Fairchild directly or from Authorized Fairchild Distributors are genuine parts, have full traceability, meet Fairchild's quality standards for handling and storage and provide access to Fairchild's full range of up-to-date technical and product information. Fairchild and our Authorized Distributors will stand behind all warranties and will appropriately address and warranty issues that may arise. Fairchild will not provide any warranty coverage or other assistance for parts bought from Unauthorized Sources. Fairchild is committed to combat this global problem and encourage our customers to do their part in stopping this practice by buying direct or from authorized distributors.

PRODUCT STATUS DEFINITIONS

Definition of Terms

| Datasheet Identification | Product Status | Definition |
|--------------------------|-----------------------|---|
| Advance Information | Formative / In Design | Datasheet contains the design specifications for product development. Specifications may change in any manner without notice. |
| Preliminary | First Production | Datasheet contains preliminary data; supplementary data will be published at a later date. Fairchild Semiconductor reserves the right to make changes at any time without notice to improve design. |
| No Identification Needed | Full Production | Datasheet contains final specifications. Fairchild Semiconductor reserves the right to make changes at any time without notice to improve the design. |
| Obsolete | Not In Production | Datasheet contains specifications on a product that is discontinued by Fairchild Semiconductor. The datasheet is for reference information only. |

AMEYA360

Components Supply Platform

Authorized Distribution Brand :



Website :

Welcome to visit www.ameya360.com

Contact Us :

➤ Address :

401 Building No.5, JiuGe Business Center, Lane 2301, Yishan Rd
Minhang District, Shanghai , China

➤ Sales :

Direct +86 (21) 6401-6692

Email amall@ameya360.com

QQ 800077892

Skype [ameyasales1](#) [ameyasales2](#)

➤ Customer Service :

Email service@ameya360.com

➤ Partnership :

Tel +86 (21) 64016692-8333

Email mkt@ameya360.com