

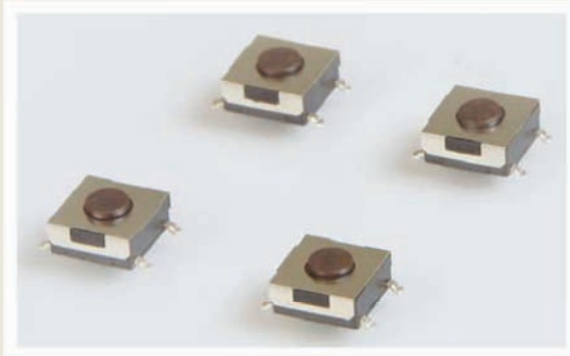

SERIES TL 3303 SWITCHES

TACT SWITCHES SMT - 6mm x 6mm



SPECIFICATIONS

Contact Rating:	50mA @ 12 VDC
Life Expectancy:	100,000 cycles typical
Contact Resistance:	100mΩ max. initial @ 2-4 VDC
Insulation Resistance:	100MΩ min.
Dielectric Strength:	250 VAC
Actuation Force:	100 ± 50 gf, 160 ± 50 gf, 260 ± 50 gf
Operating Temperature:	-20°C to 70°C
Travel:	0.25mm Typ

FEATURES & BENEFITS

- ▶ Earth ground terminal options
- ▶ Reliable dome contact technology
- ▶ Strong tactile/audible feedback

APPLICATIONS/MARKETS

- ▶ Telecommunications
- ▶ Consumer Electronics
- ▶ Audio/visual
- ▶ Medical
- ▶ Testing/instrumentation
- ▶ Computer/servers/peripherals

HOW TO ORDER

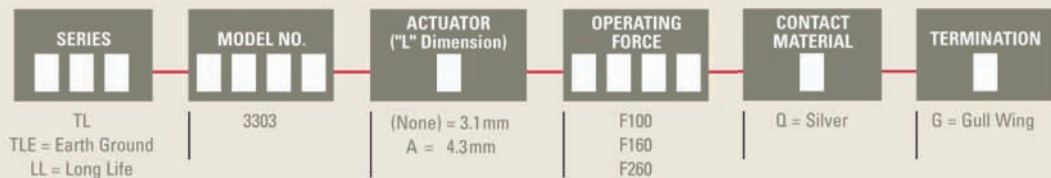

Example Ordering Number

TL-3303-F160-Q-G

Specifications subject to change without notice.

TL 3303/LL 3303

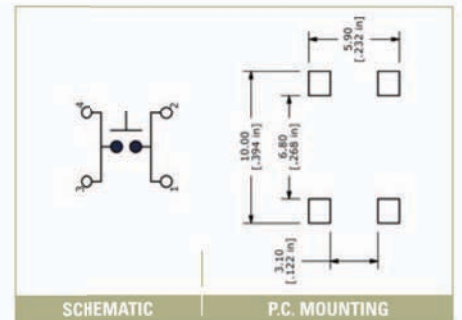
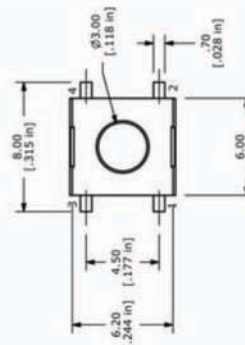
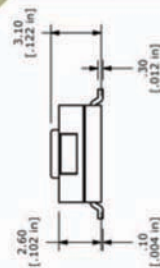

TLE 3303

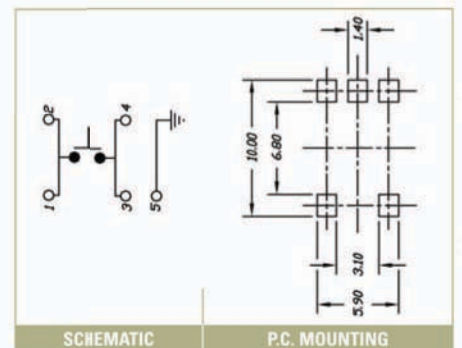
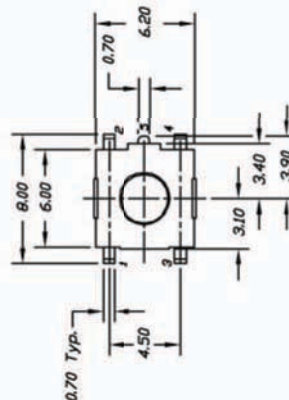
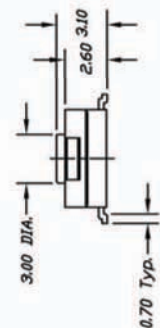

AMEYA360

Components Supply Platform

Authorized Distribution Brand :



Website :

Welcome to visit www.ameya360.com

Contact Us :

➤ Address :

401 Building No.5, JiuGe Business Center, Lane 2301, Yishan Rd
Minhang District, Shanghai , China

➤ Sales :

Direct +86 (21) 6401-6692

Email amall@ameya360.com

QQ 800077892

Skype [ameyasales1](#) [ameyasales2](#)

➤ Customer Service :

Email service@ameya360.com

➤ Partnership :

Tel +86 (21) 64016692-8333

Email mkt@ameya360.com