

**Features**

- Package in 8mm tape on a 7" diameter reel.
- Compatible with automatic placement equipment.
- Compatible with infrared and vapor phase reflow solder process.
- Multi-color type.
- Pb-free.
- ESD Protect.
- RoHS compliant version.

**Descriptions**

- The SMD Taping is much smaller than lead frame type components, thus enable smaller board size, higher packing density and reduced storage space and finally smaller equipment to be obtained.
- Light weight makes them ideal for miniature applications.

**Applications**

- Automotive: backlighting in dashboard and switch.
- Portable equipment.
- Flat backlight for LCD, switch and symbol.
- General use.

**Device Selection Guide**

Chip			Lens Color
Type	Material	Emitted Color	
R6	AlGaInP	Brilliant Red	Water Clear
GH	InGaN	Brilliant Green	
BH	InGaN	Blue	

## Package Outline Dimensions

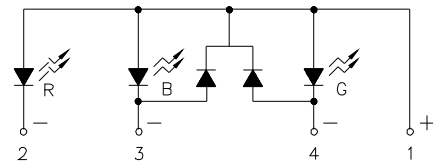
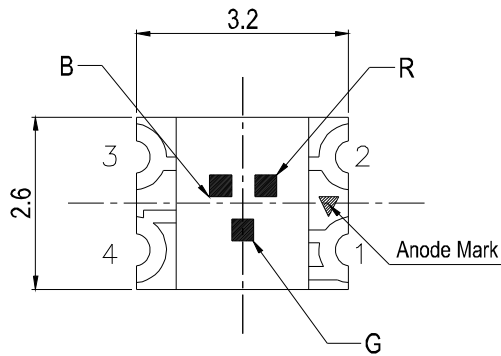

Polarity

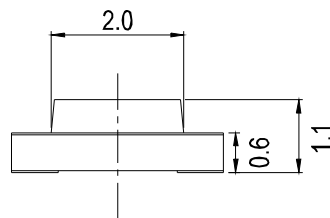

For reflow soldering (propose)

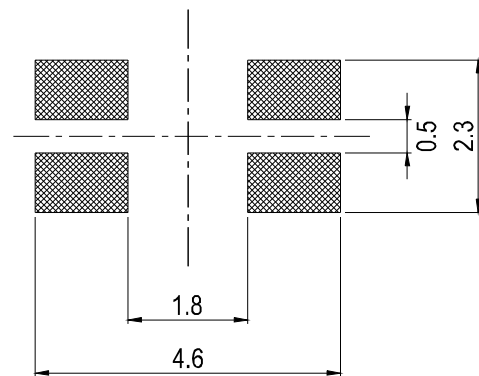
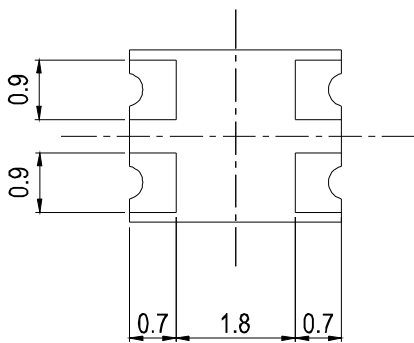

**Note:** The tolerances unless mentioned is  $\pm 0.1$ mm, Unit = mm

**Absolute Maximum Ratings (Ta=25°C)**

Parameter	Symbol	Rating	Unit
Reverse Voltage	V <sub>R</sub>	5	V
Forward Current	I <sub>F</sub>	R6:25 GH:25 BH:25	mA
Operating Temperature	T <sub>opr</sub>	-40 ~ +85	°C
Storage Temperature	T <sub>stg</sub>	-40 ~ +90	°C
Soldering Temperature	T <sub>sol</sub>	260 (for 5 seconds)	°C
Electrostatic Discharge (HBM)	ESD	R6:2000 GH:2000 BH:2000	V
Power Dissipation	P <sub>d</sub>	R6:60 GH:110 BH:110	mW
Peak Forward Current (Duty 1/10 @1KHz)	I <sub>FP</sub>	R6:60 GH:100 BH:100	mA
Soldering Temperature	T <sub>sol</sub>	Reflow Soldering : 260 °C for 10 sec Hand Soldering : 350 °C for 3 sec.	

Specific binning requirements- please contact our home office

### Electro-Optical Characteristics (Ta=25°C)

Parameter	Symbol	Min.	Typ.	Max.	Unit	Condition
Luminous Intensity	R6	90	140			If=20mA
	Iv GH	112	180	-----	mcd	
	BH	45	70			
Viewing Angle	2 θ 1/2	-----	120	-----	deg	If=20mA
Peak Wavelength	R6		632			If=20mA
	λ p GH	-----	518	-----	nm	
	BH		468			
Dominant Wavelength	R6		624			If=20mA
	λ d GH	-----	525	-----	nm	
	BH		470			
Spectrum Radiation Bandwidth	R6		20			If=20mA
	Δ λ GH	-----	35	-----	nm	
	BH		25			
Forward Voltage	R6	1.7	2.0	2.4		If=20mA
	Vf GH	2.7	3.3	3.7	V	
	BH	2.7	3.3	3.7		
Reverse Current	R6			10		VR=5V
	IR GH	-----	-----	NA	μ A	
	BH			NA		

#### Notes:

- 1.Tolerance of Luminous Intensity ±10%
- 2.Tolerance of Forward Voltage ±0.05V

## Typical Electro-Optical Characteristics Curves

R6

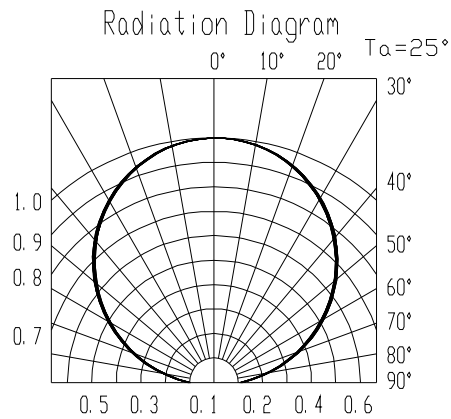
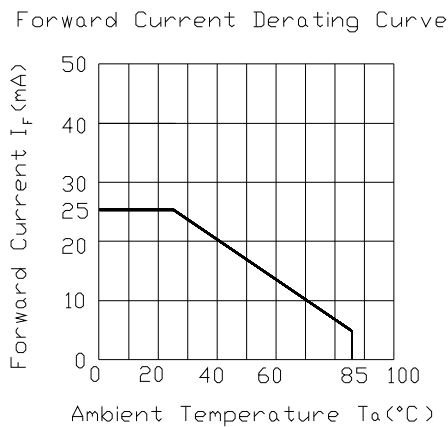
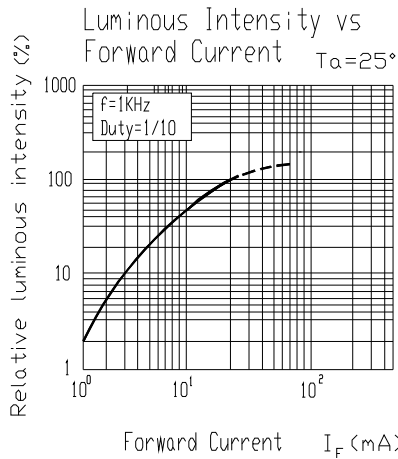
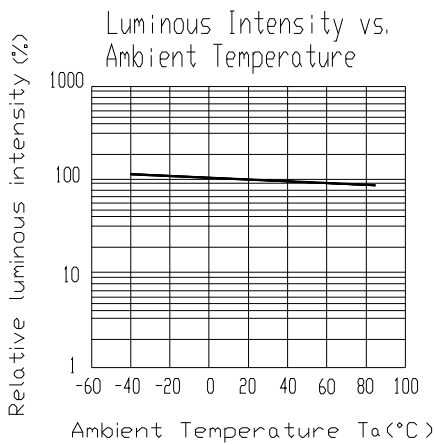
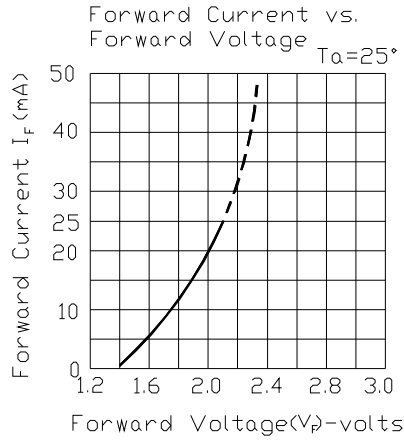
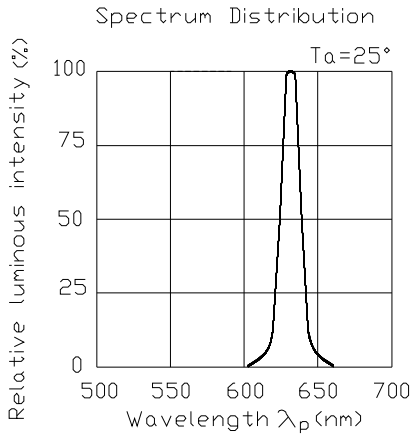

## Typical Electro-Optical Characteristics Curves

GH

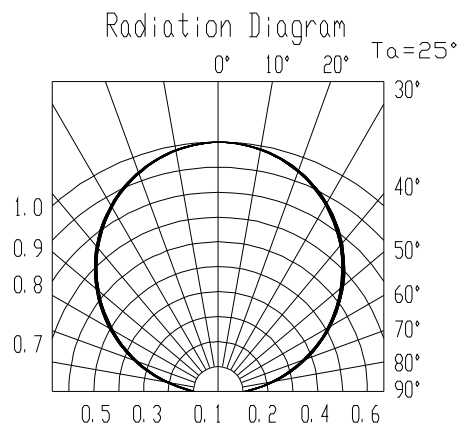
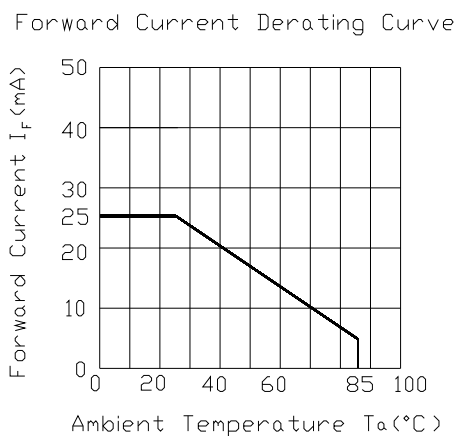
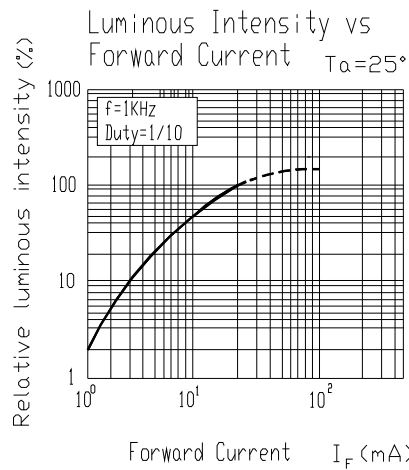
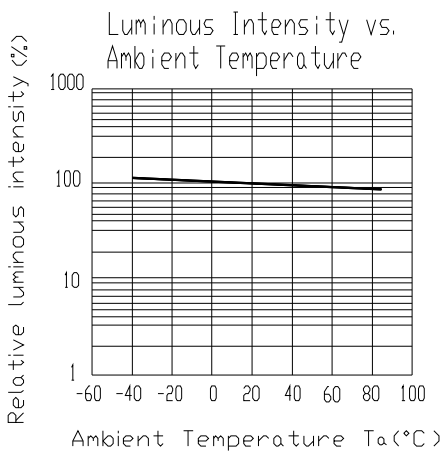
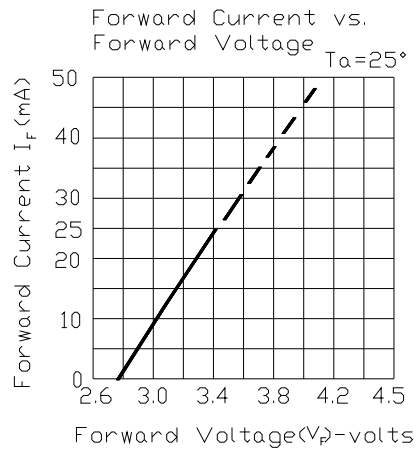
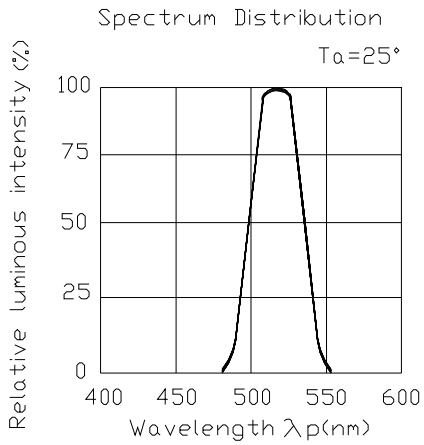

## Typical Electro-Optical Characteristics Curves

BH

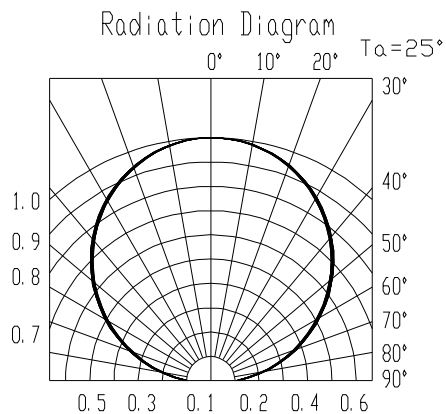
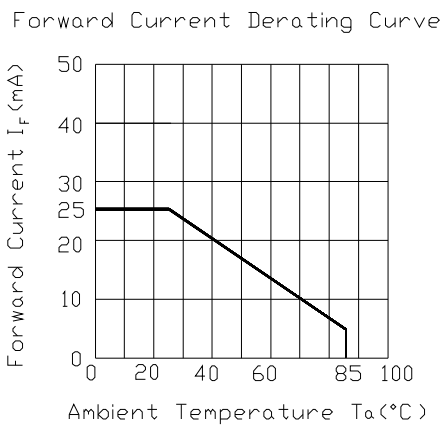
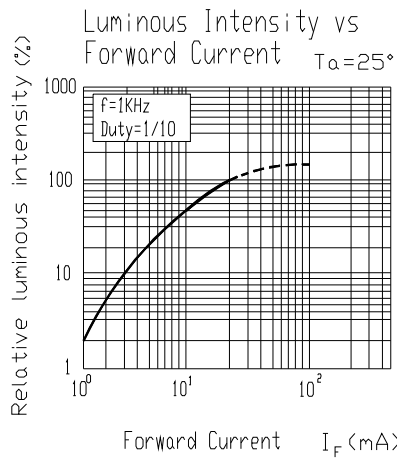
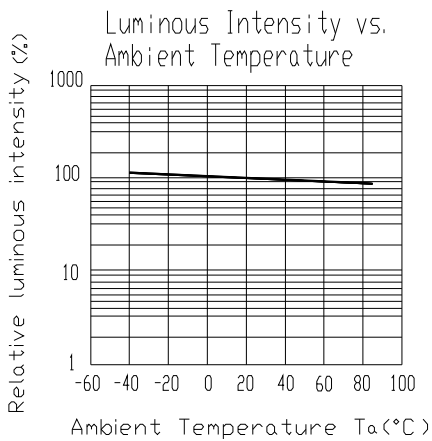
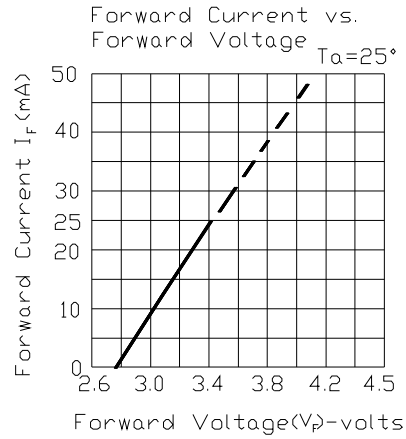
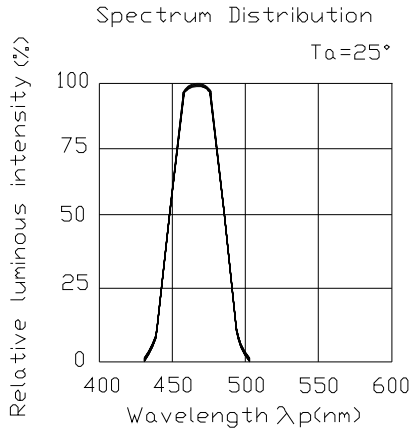

## Reel Dimensions

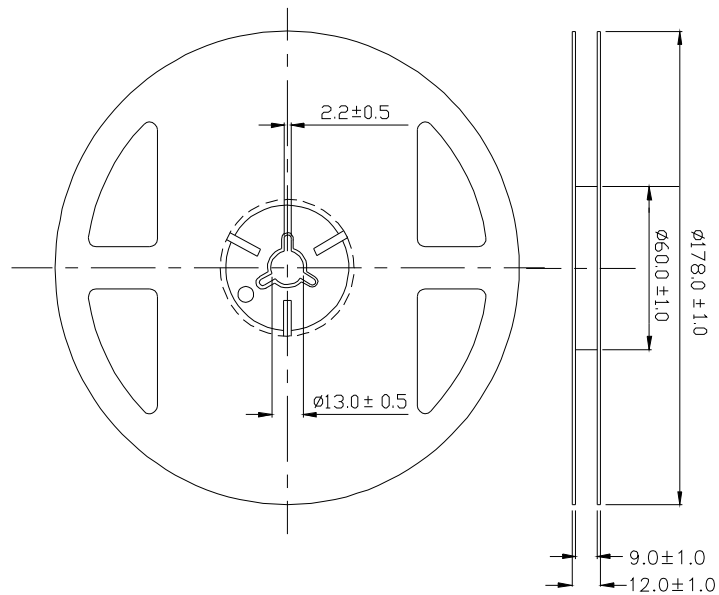

**Note:** The tolerances unless mentioned is  $\pm 0.1$ mm ,Unit = mm

**Carrier Tape Dimensions: Loaded quantity 2000 PCS per reel**

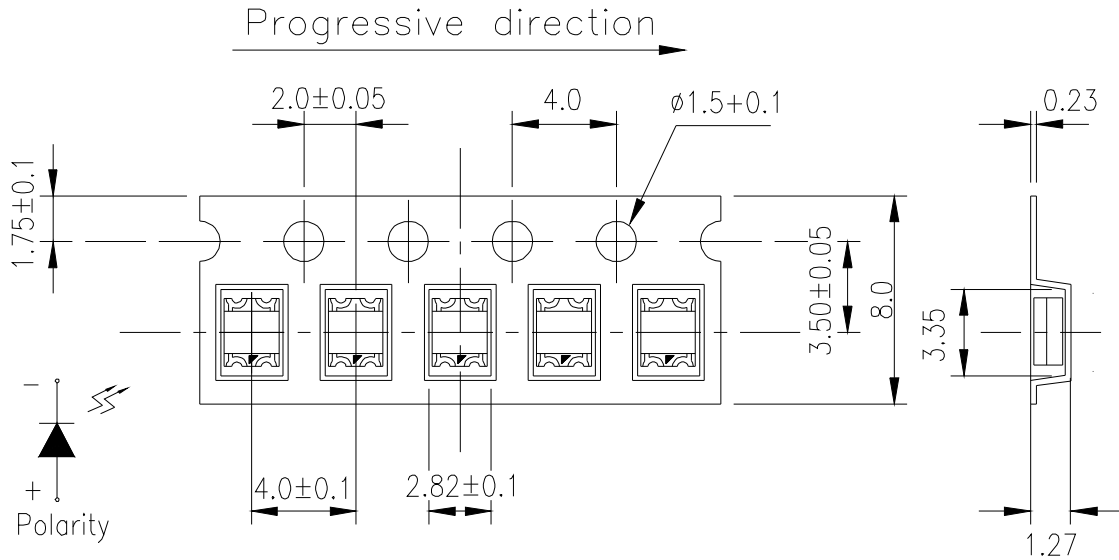

**Note:** The tolerances unless mentioned is  $\pm 0.1$ mm ,Unit = mm

**Moisture Resistant Packaging**

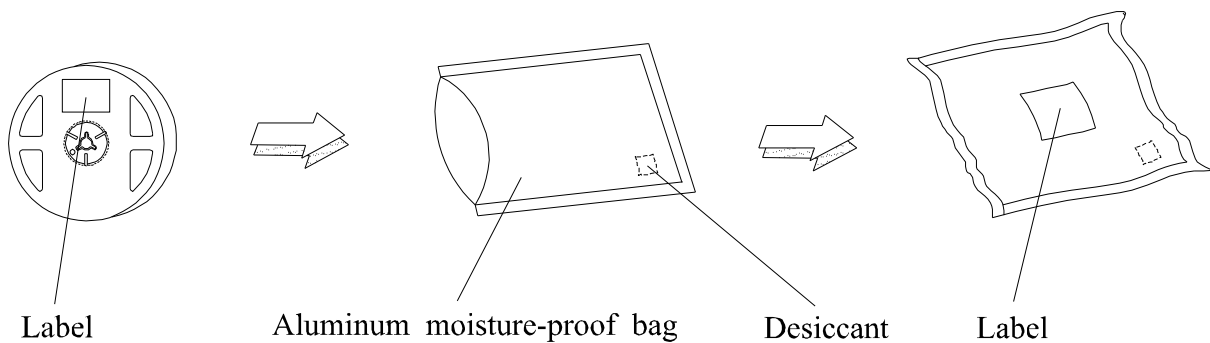

### Reliability Test Items And Conditions

The reliability of products shall be satisfied with items listed below.

Confidence level : 90%

LTPD : 10%

No.	Items	Test Condition	Test Hours/Cycles	Sample Size	Ac/Re
1	Reflow Soldering	Temp. : 260°C ±5°C Min. 5sec.	6 Min.	22 PCS.	0/1
2	Temperature Cycle	H : +100°C 15min ∫ 5 min L : -40°C 15min	300 Cycles	22 PCS.	0/1
3	Thermal Shock	H : +100°C 5min ∫ 10 sec L : -10°C 5min	300 Cycles	22 PCS.	0/1
4	High Temperature Storage	Temp. : 100°C	1000 Hrs.	22 PCS.	0/1
5	Low Temperature Storage	Temp. : -40°C	1000 Hrs.	22 PCS.	0/1
6	DC Operating Life	I <sub>F</sub> = 20 mA	1000 Hrs.	22 PCS.	0/1
7	High Temperature / High Humidity	85°C / 85%RH	1000 Hrs.	22 PCS.	0/1

## Precautions For Use

1. Customer must apply resistors for protection, otherwise a slight voltage shift will cause a big current change.

### 2. Storage

2.1 Do not open moisture proof bag before the products are ready to use.

2.2 Before opening the package: The LEDs should be kept at 30°C or less and 90%RH or less.

2.3 After opening the package: The LED's floor life is 1 year under 30 deg C or less and 60% RH or less.

If unused LEDs remain, it should be stored in moisture proof packages.

2.4 If the moisture absorbent material (silica gel) has faded away or the LEDs have exceeded the storage time, baking treatment should be performed using the following conditions.

Baking treatment :  $60\pm 5^{\circ}\text{C}$  for 24 hours.

### 3. Soldering Condition

#### 3.1 Pb-free solder temperature profile

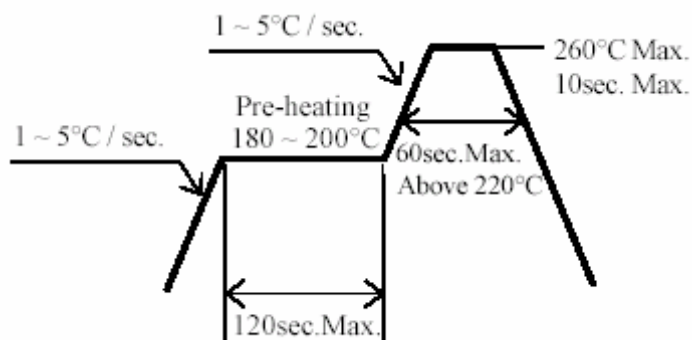

3.2 Reflow soldering should not be done more than two times.

3.3 When soldering, do not put stress on the LEDs during heating.

3.4 After soldering, do not warp the circuit board.

# AMEYA360

## Components Supply Platform

### Authorized Distribution Brand :



### Website :

Welcome to visit [www.ameya360.com](http://www.ameya360.com)

### Contact Us :

#### ➤ Address :

401 Building No.5, JiuGe Business Center, Lane 2301, Yishan Rd  
Minhang District, Shanghai , China

#### ➤ Sales :

Direct +86 (21) 6401-6692

Email [amall@ameya360.com](mailto:amall@ameya360.com)

QQ 800077892

Skype [ameyasales1](#) [ameyasales2](#)

#### ➤ Customer Service :

Email [service@ameya360.com](mailto:service@ameya360.com)

#### ➤ Partnership :

Tel +86 (21) 64016692-8333

Email [mkt@ameya360.com](mailto:mkt@ameya360.com)