

# LM48511 Boomer® Audio Power Amplifier Series 3W, Ultra-Low EMI, Filterless, Mono, Class D Audio Power Amplifier with Spread Spectrum

Check for Samples: [LM48511](#)

## FEATURES

- 3W Output into 8Ω at 5V with THD+N = 1%
- Selectable Spread Spectrum Mode Reduces EMI
- 80% Efficiency
- Independent Regulator and Amplifier Shutdown Controls
- Dynamically Selectable Regulator Output Voltages
- Filterless Class D
- 3.0V – 5.5V Operation
- Low Shutdown Current
- Click and Pop Suppression

## APPLICATIONS

- GPS
- Portable media
- Cameras
- Mobile Phones
- Handheld games

## KEY SPECIFICATIONS

- Quiescent Power Supply Current
  - $V_{DD} = 3V$  9mA (typ)
  - $V_{DD} = 5V$  13.5mA (typ)
- $P_O$  at  $V_{DD} = 5V$ ,  $PV1 = 7.8V$ ,  $R_L = 8\Omega$ , THD+N = 1% 3.0W (typ)
- $P_O$  at  $V_{DD} = 3V$ ,  $PV1 = 4.8V$ ,  $R_L = 8\Omega$ , THD+N = 1% 1W (typ)
- $P_O$  at  $V_{DD} = 5V$ ,  $PV1 = 7.8V$ ,  $R_L = 4\Omega$ , THD+N = 1% 5.4W (typ)
- Shutdown Current at  $V_{DD} = 3V$  0.01μA (typ)

## DESCRIPTION

The LM48511 integrates a boost converter with a high efficiency Class D audio power amplifier to provide 3W continuous power into an 8Ω speaker when operating from a 5V power supply. When operating from a 3V to 4V power supply, the LM48511 can be configured to drive 1 to 2.5W into an 8Ω load with less than 1% distortion (THD+N). The Class D amplifier features a low noise PWM architecture that eliminates the output filter, reducing external component count, board area consumption, system cost, and simplifying design. A selectable spread spectrum modulation scheme suppresses RF emissions, further reducing the need for output filters.

The LM48511's switching regulator is a current-mode boost converter operating at a fixed frequency of 1MHz. Two selectable feedback networks allow the LM48511 regulator to dynamically switch between two different output voltages, improving efficiency by optimizing the amplifier's supply voltage based on battery voltage and output power requirements.

The LM48511 is designed for use in portable devices, such as GPS, mobile phones, and MP3 players. The high, 80% efficiency at 5V, extends battery life when compared to Boosted Class AB amplifiers. Independent regulator and amplifier shutdown controls optimize power savings by disabling the regulator when high output power is not required.

The gain of the LM48511 is set by external resistors, which allows independent gain control from multiple sources by summing the signals. Output short circuit and thermal overload protection prevent the device from damage during fault conditions. Superior click and pop suppression eliminates audible transients during power-up and shutdown.



Please be aware that an important notice concerning availability, standard warranty, and use in critical applications of Texas Instruments semiconductor products and disclaimers thereto appears at the end of this data sheet.

All trademarks are the property of their respective owners.

EMI Graph

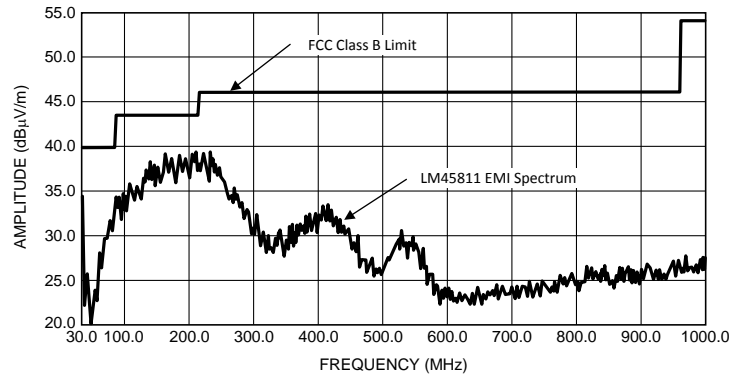

Figure 1. LM48511 RF Emissions — 3 inch cable

Typical Application

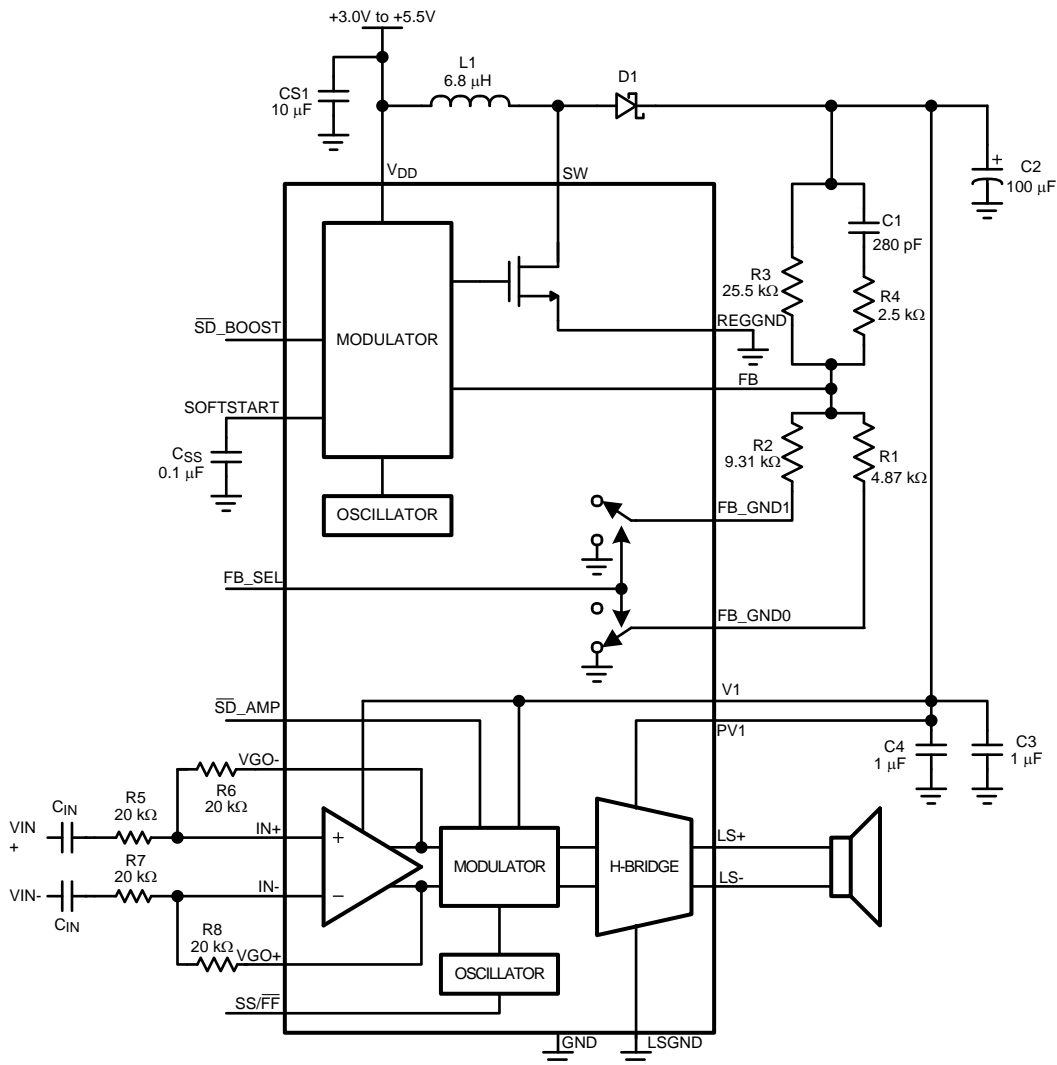

Figure 2. Typical LM48511 Audio Amplifier Application Circuit

Connection Diagram

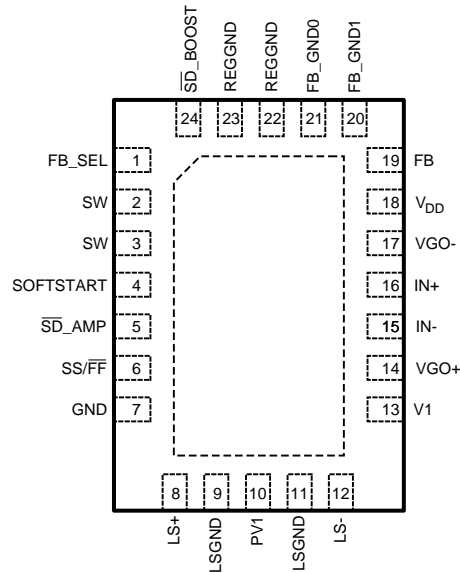

Figure 3. 24-Pin WQFN  
Top View  
See NHZ0024B Package

PIN DESCRIPTIONS

WQFN-24 Pin	Name	Function
1	FB_SEL	Regulator Feedback Select. Connect to VDD to select feedback network connected to FB_GND1. Connect to GND to select feedback network connected to FB_GND0.
2, 3	SW	Drain of the Internal FET Switch
4	SOFTSTART	Soft Start Capacitor
5	SD_AMP	Amplifier Active Low Shutdown. Connect to VDD for normal operation. Connect to GND to disable amplifier.
6	SS/FF	Modulation Mode Select. Connect to VDD for spread spectrum mode (SS). Connect to GND for fixed frequency mode (FF).
7	GND	Signal Ground
8	LS+	Amplifier Non-Inverting Output
9, 11	LSGND	Amplifier H-Bridge Ground
10	PV1	Amplifier H-Bridge Power Supply. Connect to V1.
12	LS-	Amplifier Inverting Output
13	V1	Amplifier Supply Voltage. Connect to PV1
14	VGO+	Amplifier Non-Inverting Gain Output
15	IN-	Amplifier Inverting Input
16	IN+	Amplifier Non-Inverting Input
17	VGO-	Amplifier Inverting Gain Output
18	VDD	Power Supply
19	FB	Regulator Feedback Input. Connect FB to an external resistive voltage divider to set the boost output voltage.
20	FB_GND1	Ground return for R <sub>3</sub> , R <sub>2</sub> resistor divider
21	FB_GND0	Ground return for R <sub>3</sub> , R <sub>1</sub> resistor divider
22, 23	REGGND	Power Ground (Booster)
24	SD_BOOST	Regulator Active Low Shutdown. Connect to VDD for normal operation. Connect to GND to disable regulator.

**PIN DESCRIPTIONS (continued)**

WQFN-24 Pin	Name	Function
DAP		To be soldered to board for enhanced thermal dissipation. Connect to GND plane.



These devices have limited built-in ESD protection. The leads should be shorted together or the device placed in conductive foam during storage or handling to prevent electrostatic damage to the MOS gates.

**Absolute Maximum Ratings**<sup>(1)(2)(3)</sup>

Supply Voltage ( $V_{DD}$ , $PV_1$ , $V_1$ )		9V
Storage Temperature		-65°C to +150°C
Input Voltage		-0.3V to $V_{DD} + 0.3V$
Power Dissipation <sup>(4)</sup>		Internally limited
ESD Susceptibility <sup>(5)</sup>		2000V
ESD Susceptibility <sup>(6)</sup>		200V
Junction Temperature		150°C
Thermal Resistance	$\theta_{JC}$	3.8°C/W
	$\theta_{JA}$	32.8°C/W

- (1) The *Electrical Characteristics* tables list ensured specifications under the listed *Recommended Operating Conditions* except as otherwise modified or specified by the *Electrical Characteristics Conditions* and/or Notes. Typical specifications are estimations only and are not ensured.
- (2) “*Absolute Maximum Ratings*” indicate limits beyond which damage to the device may occur, including inoperability and degradation of device reliability and/or performance. Functional operation of the device and/or non-degradation at the *Absolute Maximum Ratings* or other conditions beyond those indicated in the *Recommended Operating Conditions* is not implied. The *Recommended Operating Conditions* indicate conditions at which the device is functional and the device should not be operated beyond such conditions. All voltages are measured with respect to the ground pin, unless otherwise specified.
- (3) If Military/Aerospace specified devices are required, please contact the TI Sales Office/ Distributors for availability and specifications.
- (4) The maximum power dissipation must be derated at elevated temperatures and is dictated by  $T_{JMAX}$ ,  $\theta_{JA}$ , and the ambient temperature,  $T_A$ . The maximum allowable power dissipation is  $P_{DMAX} = (T_{JMAX} - T_A) / \theta_{JA}$  or the number given in *Absolute Maximum Ratings*, whichever is lower. For the LM48511, see [power derating](#) curves for additional information.
- (5) Human body model, applicable std. JESD22-A114C.
- (6) Machine model, applicable std. JESD22-A115-A.

**Operating Ratings**

Temperature Range $T_{MIN} \leq T_A \leq T_{MAX}$		-40°C $\leq T_A \leq$ +85°C
Supply Voltage ( $V_{DD}$ )		3.0V $\leq V_{DD} \leq$ 5.5V
Amplifier Voltage ( $PV_1$ , $V_1$ )		4.8V $\leq PV_1 \leq$ 8.0V

**Electrical Characteristics  $V_{DD} = 5.0V^{(1)(2)(3)}$** 

The following specifications apply for  $V_{DD} = 5.0V$ ,  $PV_1 = 7.8V$  (continuous mode),  $A_V = 2V/V$ ,  $R_3 = 25.5k\Omega$ ,  $R_{LS} = 4.87k\Omega$ ,  $R_L = 8\Omega$ ,  $f = 1kHz$ ,  $SS/\overline{FF} = GND$ , unless otherwise specified. Limits apply for  $T_A = 25^\circ C$ .

Symbol	Parameter	Conditions	LM48511		Units (Limits)
			Typical <sup>(4)</sup>	Limit <sup>(5)</sup>	
$I_{DD}$	Quiescent Power Supply Current	$V_{IN} = 0, R_{LOAD} = \infty$			
		Fixed Frequency Mode (FF)	13.5		mA (max)
		Spread Spectrum Mode (SS)	14.5	22	mA (max)
$I_{SD}$	Shutdown Current <sup>(6)</sup>	$V_{SD\_BOOST} = V_{SD\_AMP} = SS = FB\_SEL = GND$	0.11	1	$\mu A$ (max)
$V_{IH}$	Logic Voltage Input High			1.4	V (min)
$V_{IL}$	Logic Voltage Input Low			0.4	V (max)
$T_{WU}$	Wake-up Time	$C_{SS} = 0.1\mu F$	49		ms
$V_{OS}$	Output Offset Voltage	<sup>(7)</sup>	0.01	3	mV
$P_O$	Output Power	$R_L = 8\Omega$ $f = 1kHz, BW = 22kHz$			
		THD+N = 1% FF SS	3.0 3.0	2.6	W (min) W
		THD+N = 10% FF SS	3.8 3.8		W W
		$R_L = 4\Omega$ $f = 1kHz, BW = 22kHz$			
		THD+N = 1% FF SS	5.4 5.4		W W
		THD+N = 10% FF SS	6.7 6.7		W W
THD+N	Total Harmonic Distortion + Noise	$P_O = 2W, f = 1kHz, R_L = 8\Omega$			
		FF SS	0.03 0.03		% %
		$P_O = 3W, f = 1kHz, R_L = 4\Omega$			
		FF SS	0.04 0.05		% %
$\epsilon_{OS}$	Output Noise	$f = 20Hz$ to $20kHz$ Inputs to AC GND, No weighting			
		FF SS	32 32		$\mu V_{RMS}$ $\mu V_{RMS}$
		$f = 20Hz$ to $20kHz$ Inputs to AC GND, A weighted			
		FF SS	22 22		$\mu V_{RMS}$ $\mu V_{RMS}$

- (1) "Absolute Maximum Ratings" indicate limits beyond which damage to the device may occur, including inoperability and degradation of device reliability and/or performance. Functional operation of the device and/or non-degradation at the *Absolute Maximum Ratings* or other conditions beyond those indicated in the *Recommended Operating Conditions* is not implied. The *Recommended Operating Conditions* indicate conditions at which the device is functional and the device should not be operated beyond such conditions. All voltages are measured with respect to the ground pin, unless otherwise specified.
- (2) The *Electrical Characteristics* tables list ensured specifications under the listed *Recommended Operating Conditions* except as otherwise modified or specified by the *Electrical Characteristics Conditions* and/or Notes. Typical specifications are estimations only and are not ensured.
- (3)  $R_L$  is a resistive load in series with two inductors to simulate an actual speaker load for  $R_L = 8\Omega$ , the load is  $15\mu H + 8\Omega + 15\mu H$ . For  $R_L = 4\Omega$ , the load is  $15\mu H + 4\Omega + 15\mu H$ .
- (4) Typical values represent most likely parametric norms at  $T_A = +25^\circ C$ , and at the *Recommended Operation Conditions* at the time of product characterization and are not specified.
- (5) Datasheet min/max specification limits are specified by test or statistical analysis.
- (6) Shutdown current is measured with components R1 and R2 removed.
- (7) Offset voltage is determined by:  $(I_{DD} \text{ (with load)} - I_{DD} \text{ (no load)}) \times R_L$ .

### Electrical Characteristics $V_{DD} = 5.0V^{(1)(2)(3)}$ (continued)

The following specifications apply for  $V_{DD} = 5.0V$ ,  $PV_1 = 7.8V$  (continuous mode),  $A_V = 2V/V$ ,  $R_3 = 25.5k\Omega$ ,  $R_{LS} = 4.87k\Omega$ ,  $R_L = 8\Omega$ ,  $f = 1kHz$ ,  $SS/FF = GND$ , unless otherwise specified. Limits apply for  $T_A = 25^\circ C$ .

Symbol	Parameter	Conditions	LM48511		Units (Limits)
			Typical <sup>(4)</sup>	Limit <sup>(5)</sup>	
PSRR	Power Supply Rejection Ratio (Input Referred)	$V_{RIPPLE} = 200mV_{P-P}$ Sine, $f_{RIPPLE} = 217Hz$ , FF SS	88 87		dB dB
		$V_{RIPPLE} = 200mV_{P-P}$ Sine, $f_{RIPPLE} = 1kHz$ , FF SS	88 85		dB dB
		$V_{RIPPLE} = 200mV_{P-P}$ Sine, $f_{RIPPLE} = 10kHz$ , FF SS	77 76		dB dB
CMRR	Common Mode Rejection Ratio (Input Referred)	$V_{RIPPLE} = 1V_{P-P}$ , $f_{RIPPLE} = 217Hz$	73		dB
$\eta$	Efficiency	$f = 1kHz$ , $R_L = 8\Omega$ , $P_O = 1W$	80		%
$V_{FB}$	Feedback Pin Reference Voltage <sup>(8)</sup>		1.23		V

(8) Feedback pin reference voltage is measured with the Audio Amplifier disconnected from the Boost converter (the Boost converter is unloaded).

### Electrical Characteristics $V_{DD} = 3.6V^{(1)(2)(3)}$

The following specifications apply for  $V_{DD} = 3.6V$ ,  $PV_1 = 7V$  (continuous mode),  $A_V = 2V/V$ ,  $R_3 = 25.5k\Omega$ ,  $R_{LS} = 5.36k\Omega$ ,  $R_L = 8\Omega$ ,  $f = 1kHz$ ,  $SS/FF = GND$ , unless otherwise specified. Limits apply for  $T_A = 25^\circ C$ .

Symbol	Parameter	Conditions	LM48511		Units (Limits)
			Typical <sup>(4)</sup>	Limit <sup>(5)</sup>	
$I_{DD}$	Quiescent Power Supply Current	$V_{IN} = 0$ , $R_{LOAD} = \infty$			
		Fixed Frequency Mode (FF)	16		mA (max)
		Spread Spectrum Mode (SS)	17.5	26.6	mA (max)
$I_{SD}$	Shutdown Current <sup>(6)</sup>	$V_{SD\_BOOST} = V_{SD\_AMP} = SS = FB\_SEL = GND$	0.03	1	$\mu A$ (max)
$V_{IH}$	Logic Voltage Input High		0.96	1.4	V (min)
$V_{IL}$	Logic Voltage Input Low		0.84	0.4	V (min)
$T_{WU}$	Wake-up Time	$C_{SS} = 0.1\mu F$	50		ms
$V_{OS}$	Output Offset Voltage	<sup>(7)</sup>	0.04		mV

- (1) "Absolute Maximum Ratings" indicate limits beyond which damage to the device may occur, including inoperability and degradation of device reliability and/or performance. Functional operation of the device and/or non-degradation at the *Absolute Maximum Ratings* or other conditions beyond those indicated in the *Recommended Operating Conditions* is not implied. The *Recommended Operating Conditions* indicate conditions at which the device is functional and the device should not be operated beyond such conditions. All voltages are measured with respect to the ground pin, unless otherwise specified.
- (2) The *Electrical Characteristics* tables list ensured specifications under the listed *Recommended Operating Conditions* except as otherwise modified or specified by the *Electrical Characteristics Conditions* and/or Notes. Typical specifications are estimations only and are not ensured.
- (3)  $R_L$  is a resistive load in series with two inductors to simulate an actual speaker load for  $R_L = 8\Omega$ , the load is  $15\mu H + 8\Omega + 15\mu H$ . For  $R_L = 4\Omega$ , the load is  $15\mu H + 4\Omega + 15\mu H$ .
- (4) Typical values represent most likely parametric norms at  $T_A = +25^\circ C$ , and at the *Recommended Operation Conditions* at the time of product characterization and are not specified.
- (5) Datasheet min/max specification limits are specified by test or statistical analysis.
- (6) Shutdown current is measured with components R1 and R2 removed.
- (7) Offset voltage is determined by:  $(I_{DD} \text{ (with load)} - I_{DD} \text{ (no load)}) \times R_L$ .

**Electrical Characteristics  $V_{DD} = 3.6V^{(1)(2)(3)}$  (continued)**

The following specifications apply for  $V_{DD} = 3.6V$ ,  $PV1 = 7V$  (continuous mode),  $A_V = 2V/V$ ,  $R_3 = 25.5k\Omega$ ,  $R_{LS} = 5.36k\Omega$ ,  $R_L = 8\Omega$ ,  $f = 1kHz$ ,  $SS/FF = GND$ , unless otherwise specified. Limits apply for  $T_A = 25^\circ C$ .

Symbol	Parameter	Conditions	LM48511		Units (Limits)
			Typical <sup>(4)</sup>	Limit <sup>(5)</sup>	
$P_O$	Output Power	$R_L = 8\Omega$ , $f = 1kHz$ , $BW = 22kHz$			
		THD+N = 1%			
		FF	2.5		W
		SS	2.5		W
		THD+N = 10%			
		FF	3.0		W
SS	3.0		W		
$P_O$	Output Power	$R_L = 4\Omega$ , $f = 1kHz$ , $BW = 22kHz$			
		THD+N = 1%			
		FF	4.3		W
		SS	4.2		W
		THD+N = 10%			
		FF	5.4		W
SS	5.3		W		
THD+N	Total Harmonic Distortion + Noise	$P_O = 1.5W$ , $f = 1kHz$ , $R_L = 8\Omega$			
		FF	0.03		%
		SS	0.03		%
		$P_O = 3W$ , $f = 1kHz$ , $R_L = 4\Omega$			
THD+N	Total Harmonic Distortion + Noise	FF	0.04		%
		SS	0.05		%
		$f = 20Hz$ to $20kHz$ Inputs to AC GND, No weighting			
		FF	35		$\mu V_{RMS}$
$\epsilon_{OS}$	Output Noise	SS	36		$\mu V_{RMS}$
		$f = 20Hz$ to $20kHz$ Inputs to AC GND, A weighted			
		FF	25		$\mu V_{RMS}$
		SS	26		$\mu V_{RMS}$
PSRR	Power Supply Rejection Ratio (Input Referred)	$V_{RIPPLE} = 200mV_{P-P}$ Sine, $f_{RIPPLE} = 217Hz$			
		FF	85		dB
		SS	86		dB
		$V_{RIPPLE} = 200mV_{P-P}$ Sine, $f_{RIPPLE} = 1kHz$			
		FF	87		dB
		SS	86		dB
PSRR	Power Supply Rejection Ratio (Input Referred)	$V_{RIPPLE} = 200mV_{P-P}$ Sine, $f_{RIPPLE} = 10kHz$			
		FF	78		dB
		SS	77		dB
CMRR	Common Mode Rejection Ratio (Input Referred)	$V_{RIPPLE} = 1V_{P-P}$ , $f_{RIPPLE} = 217Hz$	73		dB
$\eta$	Efficiency	$f = 1kHz$ , $R_L = 8\Omega$ , $P_O = 1W$	77		%
$V_{FB}$	Feedback Pin Reference Voltage <sup>(8)</sup>		1.23		V

(8) Feedback pin reference voltage is measured with the Audio Amplifier disconnected from the Boost converter (the Boost converter is unloaded).

### Electrical Characteristics $V_{DD} = 3.0V^{(1)(2)(3)}$

The following specifications apply for  $V_{DD} = 3.0V$ ,  $PV1 = 4.8V$  (continuous mode),  $A_V = 2V/V$ ,  $R_3 = 25.5k\Omega$ ,  $R_{LS} = 9.31k\Omega$ ,  $R_L = 8\Omega$ ,  $f = 1kHz$ ,  $SS/\overline{FF} = GND$ , unless otherwise specified. Limits apply for  $T_A = 25^\circ C$ .

Symbol	Parameter	Conditions	LM48511		Units (Limits)
			Typical <sup>(4)</sup>	Limit <sup>(5)</sup>	
$I_{DD}$	Quiescent Power Supply Current	$V_{IN} = 0, R_{LOAD} = \infty$			
		Fixed Frequency Mode (FF)	9		mA (max)
		Spread Spectrum Mode (SS)	9.5		mA (max)
$I_{SD}$	Shutdown Current <sup>(6)</sup>	$V_{SD\_BOOST} = V_{SD\_AMP} = SS = FB\_SEL = GND$	0.01	1	$\mu A$
$V_{IH}$	Logic Voltage Input High		0.91		V (min)
$V_{IL}$	Logic Voltage Input Low		0.79		V
$T_{WU}$	Wake-up Time	$C_{SS} = 0.1\mu F$	49		ms
$V_{OS}$	Output Offset Voltage	<sup>(7)</sup>	0.04		mV
$P_O$	Output Power	$R_L = 8\Omega, f = 1kHz, BW = 22kHz$			
		THD+N = 1%			
		FF	1	0.84	W (min)
		SS	1		W
		THD+N = 10%			
		FF	1.3		W
SS	1.3		W		
$P_O$	Output Power	$R_L = 4\Omega, f = 1kHz, BW = 22kHz$			
		THD+N = 1%			
		FF	1.8		W
		SS	1.8		W
		THD+N = 10%			
		FF	2.2		W
SS	2.2		W		
THD+N	Total Harmonic Distortion + Noise	$P_O = 500mW, f = 1kHz, R_L = 8\Omega$			
		FF	0.02		%
		SS	0.03		%
		$P_O = 500mW, f = 1kHz, R_L = 4\Omega$			
FF	0.04		%		
SS	0.06		%		
$\epsilon_{OS}$	Output Noise	$f = 20Hz$ to $20kHz$ Inputs to AC GND, No weighting			
		FF	35		$\mu V_{RMS}$
		SS	35		$\mu V_{RMS}$
		$f = 20Hz$ to $20kHz$ Inputs to AC GND, A weighted			
FF	25		$\mu V_{RMS}$		
SS	25		$\mu V_{RMS}$		

- (1) "Absolute Maximum Ratings" indicate limits beyond which damage to the device may occur, including inoperability and degradation of device reliability and/or performance. Functional operation of the device and/or non-degradation at the *Absolute Maximum Ratings* or other conditions beyond those indicated in the *Recommended Operating Conditions* is not implied. The *Recommended Operating Conditions* indicate conditions at which the device is functional and the device should not be operated beyond such conditions. All voltages are measured with respect to the ground pin, unless otherwise specified.
- (2) The *Electrical Characteristics* tables list ensured specifications under the listed *Recommended Operating Conditions* except as otherwise modified or specified by the *Electrical Characteristics Conditions* and/or Notes. Typical specifications are estimations only and are not ensured.
- (3)  $R_L$  is a resistive load in series with two inductors to simulate an actual speaker load for  $R_L = 8\Omega$ , the load is  $15\mu H + 8\Omega + 15\mu H$ . For  $R_L = 4\Omega$ , the load is  $15\mu H + 4\Omega + 15\mu H$ .
- (4) Typical values represent most likely parametric norms at  $T_A = +25^\circ C$ , and at the *Recommended Operation Conditions* at the time of product characterization and are not specified.
- (5) Datasheet min/max specification limits are specified by test or statistical analysis.
- (6) Shutdown current is measured with components R1 and R2 removed.
- (7) Offset voltage is determined by:  $(I_{DD} \text{ (with load)} - I_{DD} \text{ (no load)}) \times R_L$ .



**Electrical Characteristics  $V_{DD} = 3.0V^{(1)(2)(3)}$  (continued)**

The following specifications apply for  $V_{DD} = 3.0V$ ,  $PV1 = 4.8V$  (continuous mode),  $A_V = 2V/V$ ,  $R_3 = 25.5k\Omega$ ,  $R_{LS} = 9.31k\Omega$ ,  $R_L = 8\Omega$ ,  $f = 1kHz$ ,  $SS/FF = GND$ , unless otherwise specified. Limits apply for  $T_A = 25^\circ C$ .

Symbol	Parameter	Conditions	LM48511		Units (Limits)
			Typical <sup>(4)</sup>	Limit <sup>(5)</sup>	
PSRR	Power Supply Rejection Ratio (Input Referred)	$V_{RIPPLE} = 200mV_{P-P}$ Sine, $f_{RIPPLE} = 217Hz$ FF SS	89 89		dB dB
		$V_{RIPPLE} = 200mV_{P-P}$ Sine, $f_{RIPPLE} = 1kHz$ FF SS	88 88		dB dB
		$V_{RIPPLE} = 200mV_{P-P}$ Sine, $f_{RIPPLE} = 10kHz$ FF SS	78 78		dB dB
CMRR	Common Mode Rejection Ratio (Input Referred)	$V_{RIPPLE} = 1V_{P-P}$ , $f_{RIPPLE} = 217Hz$	71		dB
$\eta$	Efficiency	$f = 1kHz$ , $R_L = 8\Omega$ , $P_O = 1W$	75		%
$V_{FB}$	Feedback Pin Reference Voltage <sup>(8)</sup>		1.23		V

(8) Feedback pin reference voltage is measured with the Audio Amplifier disconnected from the Boost converter (the Boost converter is unloaded).

Typical Performance Characteristics

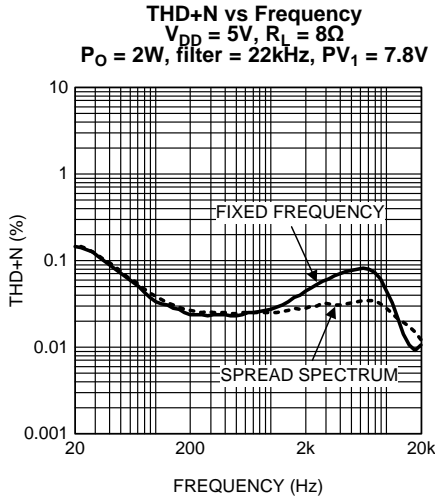

Figure 4.

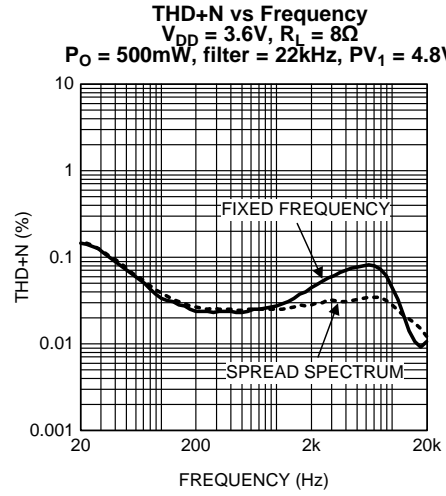

Figure 5.

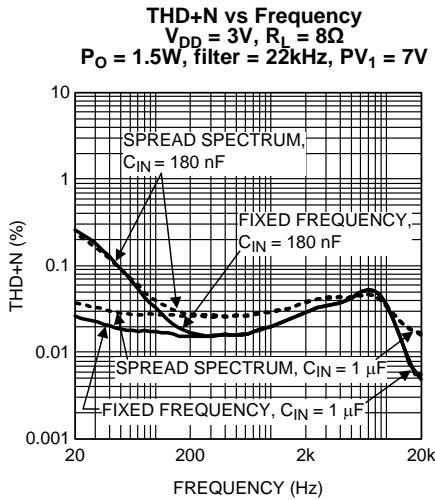

Figure 6.

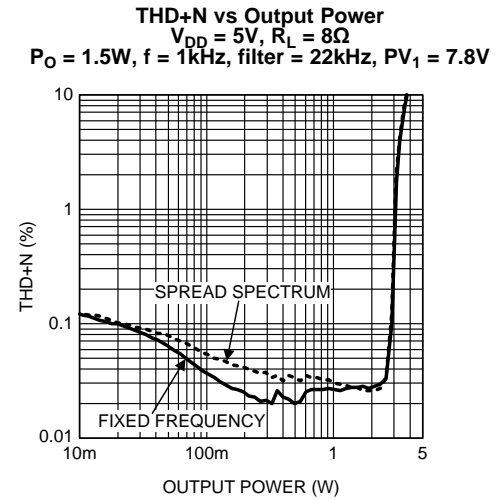

Figure 7.

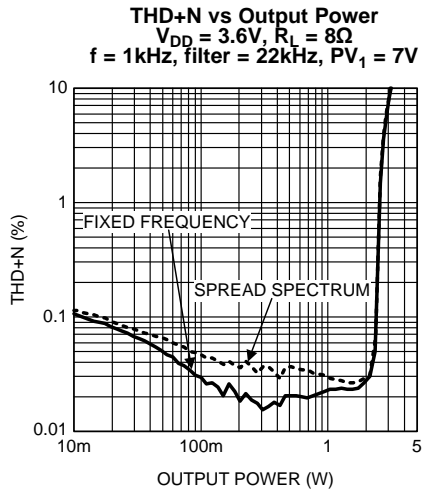

Figure 8.

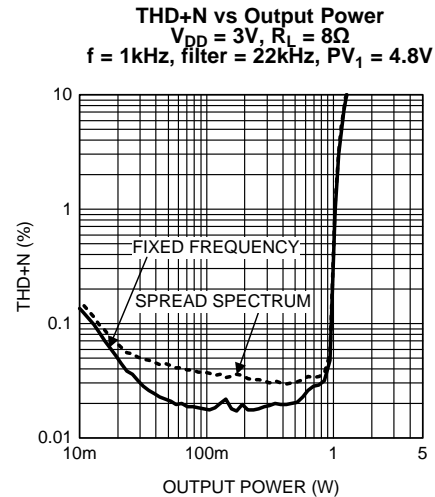

Figure 9.

Typical Performance Characteristics (continued)

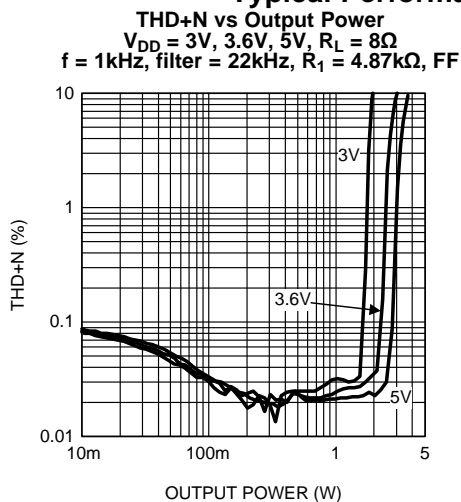

Figure 10.

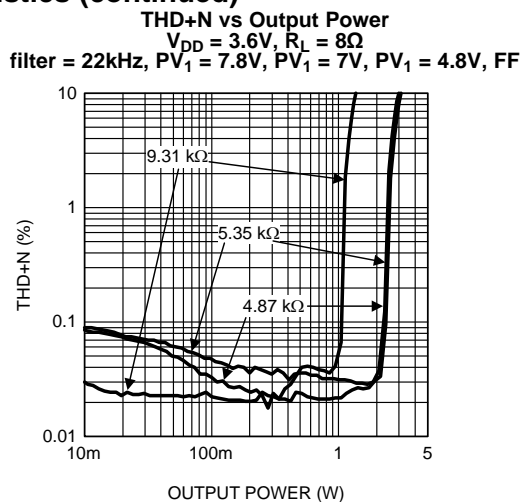

Figure 11.

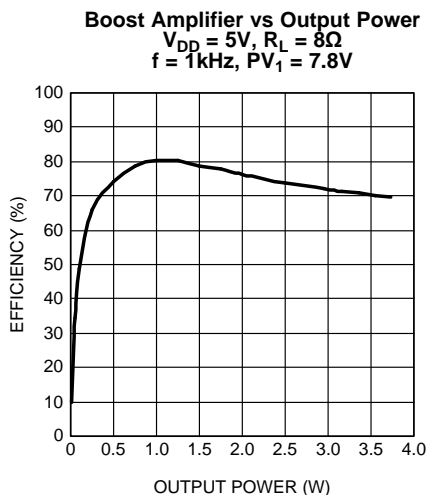

Figure 12.

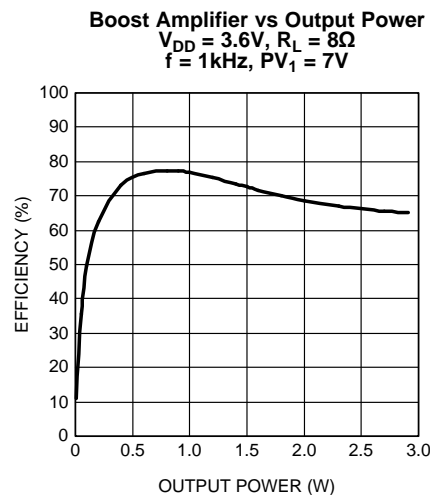

Figure 13.

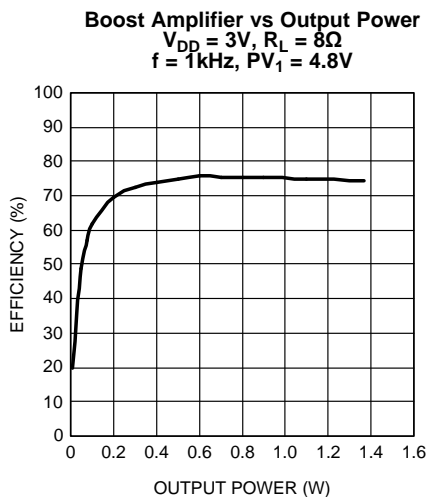

Figure 14.

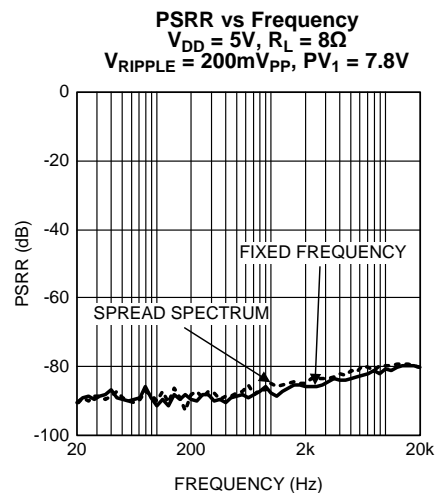

Figure 15.

**Typical Performance Characteristics (continued)**

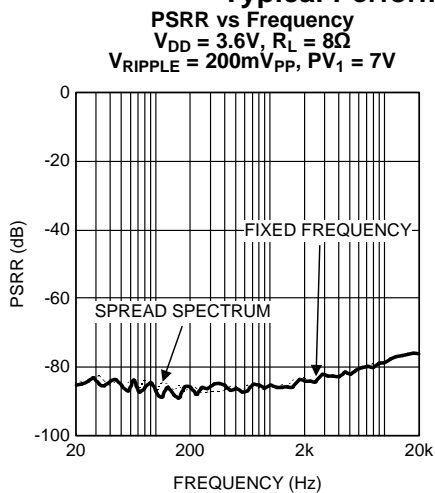

Figure 16.

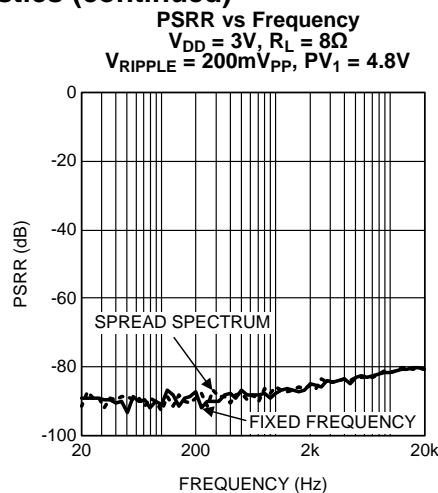

Figure 17.

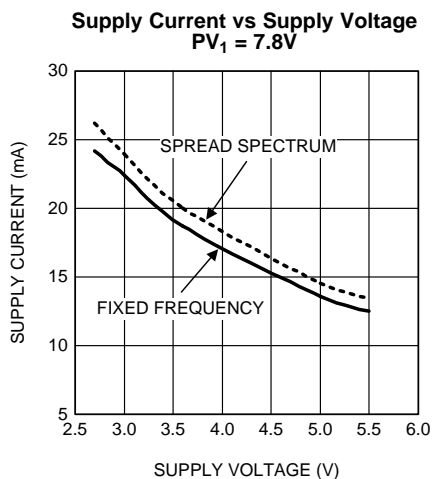

Figure 18.

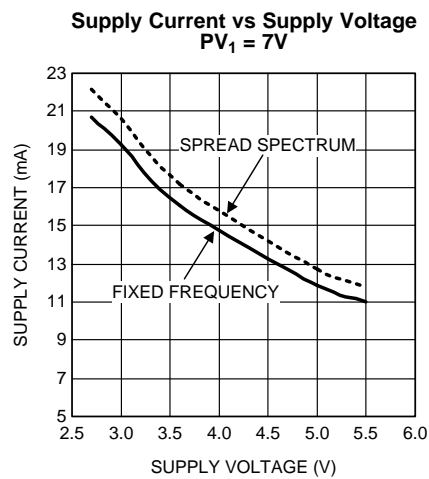

Figure 19.

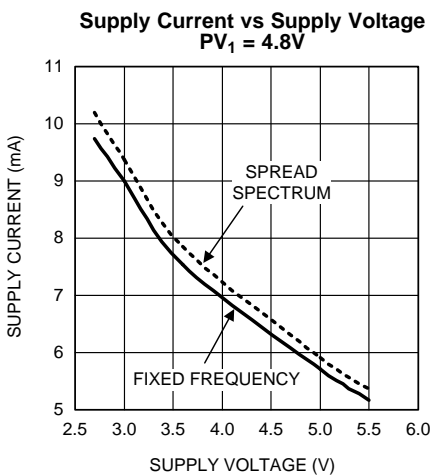

Figure 20.

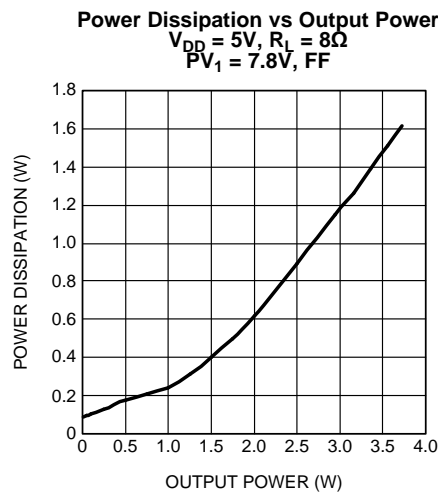

Figure 21.

**Typical Performance Characteristics (continued)**

**Power Dissipation vs Output Power**  
 $V_{DD} = 3.6V, R_L = 8\Omega$   
 $PV_1 = 7V, FF$

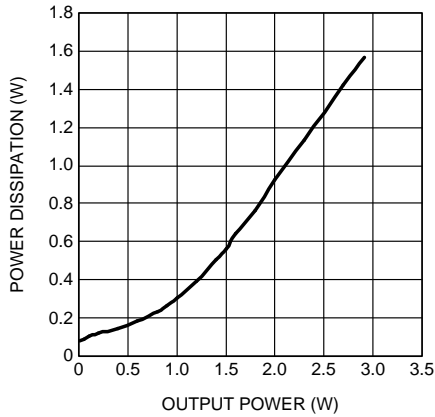

Figure 22.

**Power Dissipation vs Output Power**  
 $V_{DD} = 3V, R_L = 8\Omega$   
 $PV_1 = 4.8V, FF$

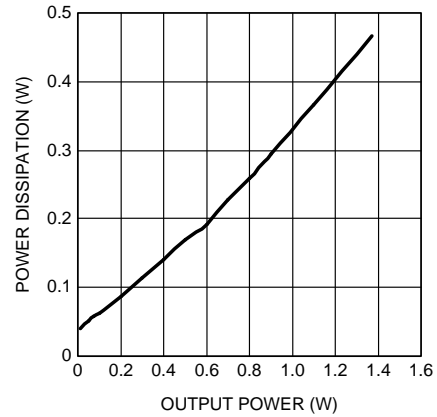

Figure 23.

**Boost Converter Efficiency vs  $I_{LOAD(DC)}$**   
 $V_{DD} = 5V, PV_1 = 7.8V$

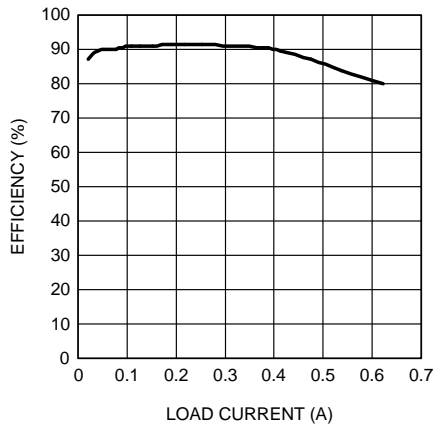

Figure 24.

**Boost Converter Efficiency vs  $I_{LOAD(DC)}$**   
 $V_{DD} = 3.6V, PV_1 = 7V$

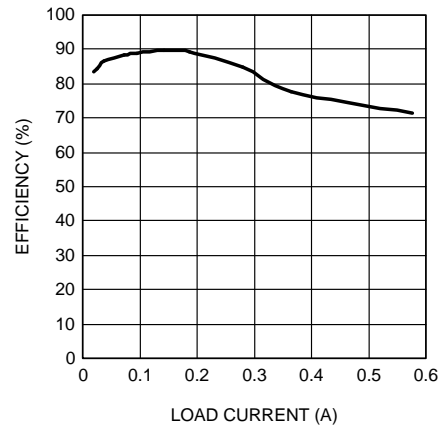

Figure 25.

**Boost Converter Efficiency vs  $I_{LOAD(DC)}$**   
 $V_{DD} = 3V, PV_1 = 4.8V$

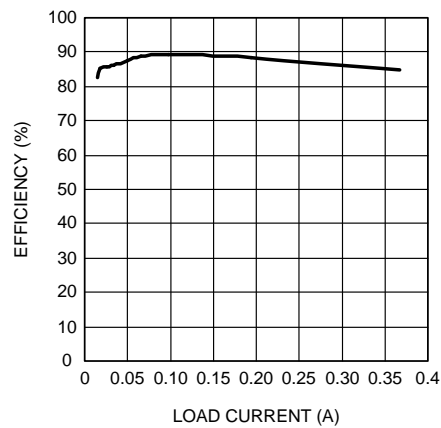

Figure 26.

## APPLICATION INFORMATION

### GENERAL AMPLIFIER FUNCTION

The LM48511 features a Class D audio power amplifier that utilizes a filterless modulation scheme, reducing external component count, conserving board space and reducing system cost. The outputs of the device transition from PV1 to GND with a 300kHz switching frequency. With no signal applied, the outputs ( $V_{LS+}$  and  $V_{LS-}$ ) switch with a 50% duty cycle, in phase, causing the two outputs to cancel. This cancellation results in no net voltage across the speaker, thus there is no current to the load in the idle state.

With the input signal applied, the duty cycle (pulse width) of the LM48511 outputs changes. For increasing output voltage, the duty cycle of  $V_{LS+}$  increases, while the duty cycle of  $V_{LS-}$  decreases. For decreasing output voltages, the converse occurs. The difference between the two pulse widths yields the differential output voltage.

### FIXED FREQUENCY

The LM48511 features two modulations schemes, a fixed frequency mode (FF) and a spread spectrum mode (SS). Select the fixed frequency mode by setting  $SS/\overline{FF} = \text{GND}$ . In fixed frequency mode, the amplifier outputs switch at a constant 300kHz. In fixed frequency mode, the output spectrum consists of the fundamental and its associated harmonics (see [Typical Performance Characteristics](#)).

### SPREAD SPECTRUM MODE

The logic selectable spread spectrum mode eliminates the need for output filters, ferrite beads or chokes. In spread spectrum mode, the switching frequency varies randomly by 10% about a 330kHz center frequency, reducing the wideband spectral content, improving EMI emissions radiated by the speaker and associated cables and traces. Where a fixed frequency class D exhibits large amounts of spectral energy at multiples of the switching frequency, the spread spectrum architecture of the LM48511 spreads that energy over a larger bandwidth (See [Typical Performance Characteristics](#)). The cycle-to-cycle variation of the switching period does not affect the audio reproduction, efficiency, or PSRR. Set  $SS/\overline{FF} = V_{DD}$  for spread spectrum mode.

### DIFFERENTIAL AMPLIFIER EXPLANATION

The LM48511 includes fully differential amplifier that features differential input and output stages. A differential amplifier amplifies the difference between the two input signals. Traditional audio power amplifiers have typically offered only single-ended inputs resulting in a 6dB reduction in signal to noise ratio relative to differential inputs. The LM48511 also offers the possibility of DC input coupling which eliminates the two external AC coupling, DC blocking capacitors. The LM48511 can be used, however, as a single ended input amplifier while still retaining its fully differential benefits. In fact, completely unrelated signals may be placed on the input pins. The LM48511 simply amplifies the difference between the signals. A major benefit of a differential amplifier is the improved common mode rejection ratio (CMRR) over single input amplifiers. The common-mode rejection characteristic of the differential amplifier reduces sensitivity to ground offset related noise injection, especially important in high noise applications.

### AUDIO AMPLIFIER POWER DISSIPATION AND EFFICIENCY

The major benefit of a Class D amplifier is increased efficiency versus a Class AB. The efficiency of the LM48511 is attributed to the region of operation of the transistors in the output stage. The Class D output stage acts as current steering switches, consuming negligible amounts of power compared to their Class AB counterparts. Most of the power loss associated with the output stage is due to the IR loss of the MOSFET on-resistance, along with switching losses due to gate charge.

### REGULATOR POWER DISSIPATION

At higher duty cycles, the increased ON-time of the switch FET means the maximum output current will be determined by power dissipation within the LM48511 FET switch. The switch power dissipation from ON-time conduction is calculated by:

$$P_{D(\text{SWITCH})} = DC \times (I_{\text{INDUCTOR(AVE)}})^2 \times R_{DS(\text{ON})} \text{ (W)}$$

where

- DC is the duty cycle.

(1)

## SHUTDOWN FUNCTION

The LM48511 features independent amplifier and regulator shutdown controls, allowing each portion of the device to be disabled or enabled independently. SD\_AMP controls the Class D amplifiers, while SD\_BOOST controls the regulator. Driving either inputs low disables the corresponding portion of the device, and reducing supply current.

When the regulator is disabled, both FB\_GND switches open, further reducing shutdown current by eliminating the current path to GND through the regulator feedback network. Without the GND switches, the feedback resistors as shown in Figure 1 would consume an additional 165µA from a 5V supply. With the regulator disabled, there is still a current path from V<sub>DD</sub>, through the inductor and diode, to the amplifier power supply. This allows the amplifier to operate even when the regulator is disabled. The voltage at PV1 and V1 will be:

$$(V_{DD} - [V_D + (I_L \times DCR)])$$

Where

- V<sub>D</sub> is the forward voltage of the Schottky diode
  - V<sub>D</sub> is the forward voltage of the Schottky diode
  - I<sub>L</sub> is the current through the inductor
  - DCR is the DC resistance of the inductor
- (2)

Additionally, when the regulator is disabled, an external voltage between 5V and 8V can be applied directly to PV1 and V1 to power the amplifier.

It is best to switch between ground and V<sub>DD</sub> for minimum current consumption while in shutdown. The LM48511 may be disabled with shutdown voltages in between GND and V<sub>DD</sub>, the idle current will be greater than the typical 0.1µA value. Increased THD+N may also be observed when a voltage of less than V<sub>DD</sub> is applied to SD\_AMP.

## REGULATOR FEEDBACK SELECT

The LM48511 regulator features two feedback paths as shown in Figure 1, which allow the regulator to easily switch between two different output voltages. The voltage divider consists of the high side resistor, R3, and the low side resistors (R<sub>LS</sub>), R1 and R2. R3 is connected to the output of the boost regulator, the mid-point of each divider is connected to FB, and the low side resistors are connected to either FB\_GND1 or FB\_GND0. FB\_SEL determines which FB\_GND switch is closed, which in turn determines which feedback path is used. For example if FB\_SEL = V<sub>DD</sub>, the FB\_GND1 switch is closed, while the FB\_GND0 switch remains open, creating a current path through the resistors connected to FB\_GND1. Conversely, if FB\_SEL = GND, the FB\_GND0 switch is closed, while the FB\_GND1 switch remains open, creating a current path through the resistors connected to FB\_GND0.

FB\_SEL can be susceptible to noise interference. To prevent an accidental state change, either bypass FB\_SEL with a 0.1µF capacitor to GND, or connect the higher voltage feedback network to FB\_GND0, and the lower voltage feedback network to FB\_GND1. Because the higher output voltage configuration typically generates more noise on V<sub>DD</sub>, this configuration minimizes the V<sub>DD</sub> noise exposure of FB\_SEL, as FB\_SEL = GND for FB\_GND0 (high voltage output) and FB\_SEL = V<sub>DD</sub> for FB\_GND1 (low voltage output).

The selectable feedback networks maximize efficiency in two ways. In applications where the system power supply voltage changes, such as a mobile GPS receiver, that transitions from battery power, to AC line, to a car power adapter, the LM48511 can be configured to generate a lower voltage when the system power supply voltages is lower, and conversely, generate a higher voltage when the system power supply is higher. See the [Setting the Regulator Output Voltage \(PV1\)](#) section.

In applications where the same speaker/amplifier combination is used for different purposes with different audio power requirements, such as a cell phone ear piece/speaker phone speaker, the ability to quickly switch between two different voltages allows for optimization of the amplifier power supply, increasing overall system efficiency. When audio power demands are low (ear piece mode) the regulator output voltage can be set lower, reducing quiescent current consumption. When audio power demands increase (speaker phone mode), a higher voltage increases the amplifier headroom, increasing the audio power delivered to the speaker.

## PROPER SELECTION OF EXTERNAL COMPONENTS

Proper selection of external components in applications using integrated power amplifiers, and switching DC-DC converters, is critical for optimizing device and system performance. Consideration to component values must be used to maximize overall system quality. The best capacitors for use with the switching converter portion of the LM48511 are multi-layer ceramic capacitors. They have the lowest ESR (equivalent series resistance) and highest resonance frequency, which makes them optimum for high frequency switching converters. When selecting a ceramic capacitor, only X5R and X7R dielectric types should be used. Other types such as Z5U and Y5F have such severe loss of capacitance due to effects of temperature variation and applied voltage, they may provide as little as 20% of rated capacitance in many typical applications. Always consult capacitor manufacturer's data curves before selecting a capacitor. High-quality ceramic capacitors can be obtained from Taiyo-Yuden and Murata.

## POWER SUPPLY BYPASSING

As with any amplifier, proper supply bypassing is critical for low noise performance and high power supply rejection. The capacitor location on both PV1, V1 and V<sub>DD</sub> pins should be as close to the device as possible.

## AUDIO AMPLIFIER GAIN SETTING RESISTOR SELECTION

The amplifier gain of the LM48511 is set by four external resistors, the input resistors, R<sub>5</sub> and R<sub>7</sub>, and the feed back resistors R<sub>6</sub> and R<sub>8</sub>. The amplifier gain is given by:

Where R<sub>IN</sub> is the input resistor and R<sub>F</sub> is the feedback resistor.

$$A_{VD} = 2 \times R_F / R_{IN} \quad (3)$$

Careful matching of the resistor pairs, R<sub>6</sub> and R<sub>8</sub>, and R<sub>5</sub> and R<sub>7</sub>, is required for optimum performance. Any mismatch between the resistors results in a differential gain error that leads to an increase in THD+N, decrease in PSRR and CMRR, as well as an increase in output offset voltage. Resistors with a tolerance of 1% or better are recommended.

The gain setting resistors should be placed as close to the device as possible. Keeping the input traces close together and of the same length increases noise rejection in noisy environments. Noise coupled onto the input traces which are physically close to each other will be common mode and easily rejected.

## AUDIO AMPLIFIER INPUT CAPACITOR SELECTION

Input capacitors may be required for some applications, or when the audio source is single-ended. Input capacitors block the DC component of the audio signal, eliminating any conflict between the DC component of the audio source and the bias voltage of the LM48511. The input capacitors create a high-pass filter with the input resistors R<sub>IN</sub>. The -3dB point of the high pass filter is found by:

$$f = 1 / 2\pi R_{IN} C_{IN} \quad (4)$$

In single-ended configurations, the input capacitor value affects click-and-pop performance. The LM48511 features a 50ms turn-on delay. Choose the input capacitor / input resistor values such that the capacitor is charged before the 50ms turn-on delay expires. A capacitor value of 0.18μF and a 20kΩ input resistor are recommended. In differential applications, the charging of the input capacitor does not affect click-and-pop significantly.

The input capacitors can also be used to remove low frequency content from the audio signal. High pass filtering the audio signal helps protect speakers that can not reproduce or may be damaged by low frequencies. When the LM48511 is using a single-ended source, power supply noise on the ground is seen as an input signal. Setting the high-pass filter point above the power supply noise frequencies, 217Hz in a GSM phone, for example, filters out the noise such that it is not amplified and heard on the output. Capacitors with a tolerance of 10% or better are recommended for impedance matching and improved CMRR and PSRR.

## SELECTING REGULATOR OUTPUT CAPACITOR

A single 100μF low ESR tantalum capacitor provides sufficient output capacitance for most applications. Higher capacitor values improve line regulation and transient response. Typical electrolytic capacitors are not suitable for switching converters that operate above 500kHz because of significant ringing and temperature rise due to self-heating from ripple current. An output capacitor with excessive ESR reduces phase margin and causes instability.



## SELECTING REGULATING BYPASS CAPACITOR

A supply bypass capacitor is required to serve as an energy reservoir for the current which must flow into the coil each time the switch turns on. This capacitor must have extremely low ESR, so ceramic capacitors are the best choice. A nominal value of 10 $\mu$ F is recommended, but larger values can be used. Since this capacitor reduces the amount of voltage ripple seen at the input pin, it also reduces the amount of EMI passed back along that line to other circuitry.

## SELECTING THE SOFTSTART (C<sub>SS</sub>) CAPACITOR

The soft-start function charges the boost converter reference voltage slowly. This allows the output of the boost converter to ramp up slowly thus limiting the transient current at startup. Selecting a soft-start capacitor (C<sub>SS</sub>) value presents a trade off between the wake-up time and the startup transient current. Using a larger capacitor value will increase wake-up time and decrease startup transient current while the opposite effect happens with a smaller capacitor value. A general guideline is to use a capacitor value 1000 times smaller than the output capacitance of the boost converter (C<sub>2</sub>). A 0.1 $\mu$ F soft-start capacitor is recommended for a typical application.

The following table shows the relationship between C<sub>SS</sub> start-up time and surge current.

C <sub>SS</sub> ( $\mu$ F)	Boost Set-up Time (ms)	Input Surge Current (mA)
0.1	5.1	330
0.22	10.5	255
0.47	21.7	220

V<sub>DD</sub> = 5V, PV<sub>1</sub> = 7.8V (continuous mode)

## SELECTING DIODE (D1)

Use a Schottkey diode, as shown in Figure 1. A 30V diode such as the DFSL230LH from Diodes Incorporated is recommended. The DFSL230LH diodes are designed to handle a maximum average current of 2A.

## DUTY CYCLE

The maximum duty cycle of the boost converter determines the maximum boost ratio of output-to-input voltage that the converter can attain in continuous mode of operation. The duty cycle for a given boost application is defined by:

$$\text{Duty Cycle} = (PV_1 + V_D - V_{DD}) / (PV_1 + V_D - V_{SW}) \quad (5)$$

This applies for continuous mode operation.

## SELECTING INDUCTOR VALUE

Inductor value involves trade-offs in performance. Larger inductors reduce inductor ripple current, which typically means less output voltage ripple (for a given size of output capacitor). Larger inductors also mean more load power can be delivered because the energy stored during each switching cycle is:

$$E = L/2 \times (I_P)^2$$

Where

- "I<sub>P</sub>" is the peak inductor current (6)

The LM48511 will limit its switch current based on peak current. With I<sub>P</sub> fixed, increasing L will increase the maximum amount of power available to the load. Conversely, using too little inductance may limit the amount of load current which can be drawn from the output. Best performance is usually obtained when the converter is operated in "continuous" mode at the load current range of interest, typically giving better load regulation and less output ripple. Continuous operation is defined as not allowing the inductor current to drop to zero during the cycle. Boost converters shift over to discontinuous operation if the load is reduced far enough, but a larger inductor stays continuous over a wider load current range.

## INDUCTOR SUPPLIES

The recommended inductor for the LM48511 is the IHLP-2525CZ-01 from Vishay Dale. When selecting an inductor, the continuous current rating must be high enough to avoid saturation at peak currents. A suitable core type must be used to minimize switching losses, and DCR losses must be considered when selecting the current rating. Use shielded inductors in systems that are susceptible to RF interference.

## SETTING THE REGULATOR OUTPUT VOLTAGE (PV1)

The output voltage of the regulator is set through one of two external resistive voltage-dividers (R3 in combination with either R1 or R2) connected to FB (Figure 1). The resistor, R4 is only for compensation purposes and does not affect the regulator output voltage. The regulator output voltage is set by the following equation:

$$PV1 = V_{FB} [1 + R3/R_{LS}]$$

Where

- $V_{FB}$  is 1.23V, and  $R_{LS}$  is the low side resistor (R1 or R2) (7)

To simplify resistor selection:

$$R_{LS} = (R3V_{FB}) / (PV1 - V_{FB}) \quad (8)$$

A value of approximately 25.5k $\Omega$  is recommended for R3.

The quiescent current of the boost regulator is directly related to the difference between its input and output voltages, the larger the difference, the higher the quiescent current. For improved power consumption the following regulator input/output voltage combinations are recommended:

V <sub>DD</sub> (V)	PV1 (V)	R3(k $\Omega$ )	R <sub>LS</sub> (k $\Omega$ )	P <sub>OUT</sub> into 8 $\Omega$ (W)
3.0	4.8	25.5	9.31	1
3.6	7.1	25.5	5.35	2.5
5	7.8	25.5	4.87	3

The values of PV1 are for continuous mode operation.

For feedback path selection, see [REGULATOR FEEDBACK SELECT](#) section.

## DISCONTINUOUS/CONTINUOUS OPERATION

The LM48511 regulator features two different switching modes. Under light load conditions, the regulator operates in a variable frequency, discontinuous, pulse skipping mode, that improves light load efficiency by minimizing losses due to MOSFET gate charge. Under heavy loads, the LM48511 regulator automatically switches to a continuous, fixed frequency PWM mode, improving load regulation. In discontinuous mode, the regulator output voltage is typically 400mV higher than the expected (calculated) voltage in continuous mode.

## I<sub>SW</sub> FEED-FORWARD COMPENSATION FOR BOOST CONVERTER

Although the LM48511 regulator is internally compensated, an external feed-forward capacitor, (C1) may be required for stability (Figure 1). The compensation capacitor places a zero in regulator loop response. The recommended frequency of the zero ( $f_z$ ) is 22.2kHz. The value of C1 is given by:

$$C1 = 1 / 2\pi R3f_z \quad (9)$$

In addition to C1, a compensation resistor, R4 is required to cancel the zero contributed by the ESR of the regulator output capacitor. Calculate the zero frequency of the output capacitor by:

$$f_{CO} = 1 / 2\pi R_{CO}C_O$$

where

- $R_{CO}$  is the ESR of the output capacitor (10)

The value of  $R_{FB3}$  is given by:

$$R4 = 1 / 2\pi f_{CO}C1 \quad (11)$$

## CALCULATING REGULATOR OUTPUT CURRENT

The load current of the boost converter is related to the average inductor current by the relation:

$$I_{AMP} = I_{INDUCTOR(AVE)} \times (1 - DC) \quad (A) \quad (12)$$

Where "DC" is the duty cycle of the application.

The switch current can be found by:

$$I_{SW} = I_{INDUCTOR(AVE)} + 1/2 (I_{RIPPLE}) \quad (A) \quad (13)$$

Inductor ripple current is dependent on inductance, duty cycle, supply voltage and frequency:

$$I_{RIPPLE} = DC \times (V_{DD} - V_{SW}) / (f \times L) \quad (A)$$

where

- $f$  = switching frequency = 1MHz (14)

combining all terms, we can develop an expression which allows the maximum available load current to be calculated:

$$I_{AMP(max)} = (1 - DC) \times [I_{SW(max)} - DC(V - V_{SW})] / 2fL \quad (A) \quad (15)$$

The equation shown to calculate maximum load current takes into account the losses in the inductor or turn-off switching losses of the FET and diode.

## DESIGN PARAMETERS $V_{SW}$ AND $I_{SW}$

The value of the FET "ON" voltage (referred to as  $V_{SW}$  in [Equation 9](#) thru [Equation 12](#)) is dependent on load current. A good approximation can be obtained by multiplying the on resistance ( $R_{DS(ON)}$ ) of the FET times the average inductor current. The maximum peak switch current the device can deliver is dependent on duty cycle.

## REVISION HISTORY

Rev	Date	Description
1.0	07/24/07	Initial released.
1.1	07/25/07	Input some text edits.
1.2	09/25/07	Changed the Amplifier Voltage (Operating Ratings section) from 5.0V to 4.8V.
1.3	11/06/07	Added another P <sub>O</sub> (@V <sub>DD</sub> = 5V, R <sub>L</sub> = 4Ω) section in the Key Specification division.
1.4	02/25/08	Edited the Notes section.
1.5	02/28/12	Deleted the "Build of Materials" (BOM) table.
1.6	03/22/12	Deleted the Typical limits (V <sub>ih</sub> and V <sub>il</sub> ) EC table.

### Changes from Revision F (May 2013) to Revision G

**Page**

- |  |           |
|--|-----------|
| <ul style="list-style-type: none"> <li>• Changed layout of National Data Sheet to TI format .....</li> </ul> | <b>19</b> |
|--|-----------|

**PACKAGING INFORMATION**

Orderable Device	Status (1)	Package Type	Package Drawing	Pins	Package Qty	Eco Plan (2)	Lead/Ball Finish	MSL Peak Temp (3)	Op Temp (°C)	Top-Side Markings (4)	Samples
LM48511SQ/NOPB	ACTIVE	WQFN	NHZ	24	1000	Green (RoHS & no Sb/Br)	CU SN	Level-1-260C-UNLIM	-40 to 85	48511SQ	<a href="#">Samples</a>
LM48511SQX/NOPB	ACTIVE	WQFN	NHZ	24	4500	Green (RoHS & no Sb/Br)	CU SN	Level-1-260C-UNLIM	-40 to 85	48511SQ	<a href="#">Samples</a>

(1) The marketing status values are defined as follows:

**ACTIVE:** Product device recommended for new designs.

**LIFEBUY:** TI has announced that the device will be discontinued, and a lifetime-buy period is in effect.

**NRND:** Not recommended for new designs. Device is in production to support existing customers, but TI does not recommend using this part in a new design.

**PREVIEW:** Device has been announced but is not in production. Samples may or may not be available.

**OBSOLETE:** TI has discontinued the production of the device.

(2) Eco Plan - The planned eco-friendly classification: Pb-Free (RoHS), Pb-Free (RoHS Exempt), or Green (RoHS & no Sb/Br) - please check <http://www.ti.com/productcontent> for the latest availability information and additional product content details.

**TBD:** The Pb-Free/Green conversion plan has not been defined.

**Pb-Free (RoHS):** TI's terms "Lead-Free" or "Pb-Free" mean semiconductor products that are compatible with the current RoHS requirements for all 6 substances, including the requirement that lead not exceed 0.1% by weight in homogeneous materials. Where designed to be soldered at high temperatures, TI Pb-Free products are suitable for use in specified lead-free processes.

**Pb-Free (RoHS Exempt):** This component has a RoHS exemption for either 1) lead-based flip-chip solder bumps used between the die and package, or 2) lead-based die adhesive used between the die and leadframe. The component is otherwise considered Pb-Free (RoHS compatible) as defined above.

**Green (RoHS & no Sb/Br):** TI defines "Green" to mean Pb-Free (RoHS compatible), and free of Bromine (Br) and Antimony (Sb) based flame retardants (Br or Sb do not exceed 0.1% by weight in homogeneous material)

(3) MSL, Peak Temp. -- The Moisture Sensitivity Level rating according to the JEDEC industry standard classifications, and peak solder temperature.

(4) Multiple Top-Side Markings will be inside parentheses. Only one Top-Side Marking contained in parentheses and separated by a "~" will appear on a device. If a line is indented then it is a continuation of the previous line and the two combined represent the entire Top-Side Marking for that device.

**Important Information and Disclaimer:** The information provided on this page represents TI's knowledge and belief as of the date that it is provided. TI bases its knowledge and belief on information provided by third parties, and makes no representation or warranty as to the accuracy of such information. Efforts are underway to better integrate information from third parties. TI has taken and continues to take reasonable steps to provide representative and accurate information but may not have conducted destructive testing or chemical analysis on incoming materials and chemicals. TI and TI suppliers consider certain information to be proprietary, and thus CAS numbers and other limited information may not be available for release.

In no event shall TI's liability arising out of such information exceed the total purchase price of the TI part(s) at issue in this document sold by TI to Customer on an annual basis.

**TAPE AND REEL INFORMATION**

**QUADRANT ASSIGNMENTS FOR PIN 1 ORIENTATION IN TAPE**

\*All dimensions are nominal

Device	Package Type	Package Drawing	Pins	SPQ	Reel Diameter (mm)	Reel Width W1 (mm)	A0 (mm)	B0 (mm)	K0 (mm)	P1 (mm)	W (mm)	Pin1 Quadrant
LM48511SQ/NOPB	WQFN	NHZ	24	1000	178.0	12.4	4.3	5.3	1.3	8.0	12.0	Q1
LM48511SQX/NOPB	WQFN	NHZ	24	4500	330.0	12.4	4.3	5.3	1.3	8.0	12.0	Q1

**TAPE AND REEL BOX DIMENSIONS**

\*All dimensions are nominal

Device	Package Type	Package Drawing	Pins	SPQ	Length (mm)	Width (mm)	Height (mm)
LM48511SQ/NOPB	WQFN	NHZ	24	1000	210.0	185.0	35.0
LM48511SQX/NOPB	WQFN	NHZ	24	4500	367.0	367.0	35.0

NHZ0024B

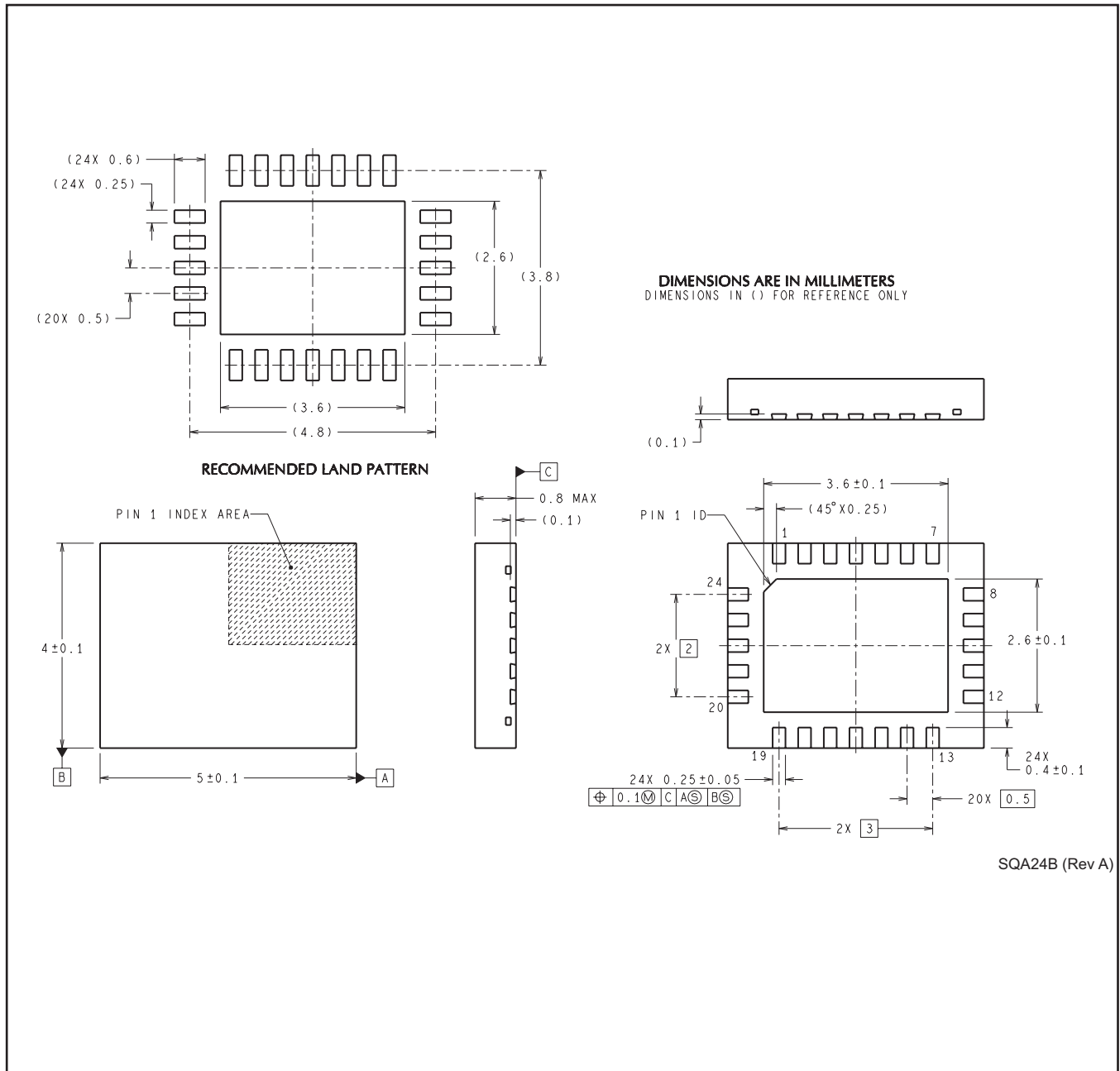



## IMPORTANT NOTICE

Texas Instruments Incorporated and its subsidiaries (TI) reserve the right to make corrections, enhancements, improvements and other changes to its semiconductor products and services per JESD46, latest issue, and to discontinue any product or service per JESD48, latest issue. Buyers should obtain the latest relevant information before placing orders and should verify that such information is current and complete. All semiconductor products (also referred to herein as "components") are sold subject to TI's terms and conditions of sale supplied at the time of order acknowledgment.

TI warrants performance of its components to the specifications applicable at the time of sale, in accordance with the warranty in TI's terms and conditions of sale of semiconductor products. Testing and other quality control techniques are used to the extent TI deems necessary to support this warranty. Except where mandated by applicable law, testing of all parameters of each component is not necessarily performed.

TI assumes no liability for applications assistance or the design of Buyers' products. Buyers are responsible for their products and applications using TI components. To minimize the risks associated with Buyers' products and applications, Buyers should provide adequate design and operating safeguards.

TI does not warrant or represent that any license, either express or implied, is granted under any patent right, copyright, mask work right, or other intellectual property right relating to any combination, machine, or process in which TI components or services are used. Information published by TI regarding third-party products or services does not constitute a license to use such products or services or a warranty or endorsement thereof. Use of such information may require a license from a third party under the patents or other intellectual property of the third party, or a license from TI under the patents or other intellectual property of TI.

Reproduction of significant portions of TI information in TI data books or data sheets is permissible only if reproduction is without alteration and is accompanied by all associated warranties, conditions, limitations, and notices. TI is not responsible or liable for such altered documentation. Information of third parties may be subject to additional restrictions.

Resale of TI components or services with statements different from or beyond the parameters stated by TI for that component or service voids all express and any implied warranties for the associated TI component or service and is an unfair and deceptive business practice. TI is not responsible or liable for any such statements.

Buyer acknowledges and agrees that it is solely responsible for compliance with all legal, regulatory and safety-related requirements concerning its products, and any use of TI components in its applications, notwithstanding any applications-related information or support that may be provided by TI. Buyer represents and agrees that it has all the necessary expertise to create and implement safeguards which anticipate dangerous consequences of failures, monitor failures and their consequences, lessen the likelihood of failures that might cause harm and take appropriate remedial actions. Buyer will fully indemnify TI and its representatives against any damages arising out of the use of any TI components in safety-critical applications.

In some cases, TI components may be promoted specifically to facilitate safety-related applications. With such components, TI's goal is to help enable customers to design and create their own end-product solutions that meet applicable functional safety standards and requirements. Nonetheless, such components are subject to these terms.

No TI components are authorized for use in FDA Class III (or similar life-critical medical equipment) unless authorized officers of the parties have executed a special agreement specifically governing such use.

Only those TI components which TI has specifically designated as military grade or "enhanced plastic" are designed and intended for use in military/aerospace applications or environments. Buyer acknowledges and agrees that any military or aerospace use of TI components which have **not** been so designated is solely at the Buyer's risk, and that Buyer is solely responsible for compliance with all legal and regulatory requirements in connection with such use.

TI has specifically designated certain components as meeting ISO/TS16949 requirements, mainly for automotive use. In any case of use of non-designated products, TI will not be responsible for any failure to meet ISO/TS16949.

### Products

Audio	<a href="http://www.ti.com/audio">www.ti.com/audio</a>
Amplifiers	<a href="http://amplifier.ti.com">amplifier.ti.com</a>
Data Converters	<a href="http://dataconverter.ti.com">dataconverter.ti.com</a>
DLP® Products	<a href="http://www.dlp.com">www.dlp.com</a>
DSP	<a href="http://dsp.ti.com">dsp.ti.com</a>
Clocks and Timers	<a href="http://www.ti.com/clocks">www.ti.com/clocks</a>
Interface	<a href="http://interface.ti.com">interface.ti.com</a>
Logic	<a href="http://logic.ti.com">logic.ti.com</a>
Power Mgmt	<a href="http://power.ti.com">power.ti.com</a>
Microcontrollers	<a href="http://microcontroller.ti.com">microcontroller.ti.com</a>
RFID	<a href="http://www.ti-rfid.com">www.ti-rfid.com</a>
OMAP Applications Processors	<a href="http://www.ti.com/omap">www.ti.com/omap</a>
Wireless Connectivity	<a href="http://www.ti.com/wirelessconnectivity">www.ti.com/wirelessconnectivity</a>

### Applications

Automotive and Transportation	<a href="http://www.ti.com/automotive">www.ti.com/automotive</a>
Communications and Telecom	<a href="http://www.ti.com/communications">www.ti.com/communications</a>
Computers and Peripherals	<a href="http://www.ti.com/computers">www.ti.com/computers</a>
Consumer Electronics	<a href="http://www.ti.com/consumer-apps">www.ti.com/consumer-apps</a>
Energy and Lighting	<a href="http://www.ti.com/energy">www.ti.com/energy</a>
Industrial	<a href="http://www.ti.com/industrial">www.ti.com/industrial</a>
Medical	<a href="http://www.ti.com/medical">www.ti.com/medical</a>
Security	<a href="http://www.ti.com/security">www.ti.com/security</a>
Space, Avionics and Defense	<a href="http://www.ti.com/space-avionics-defense">www.ti.com/space-avionics-defense</a>
Video and Imaging	<a href="http://www.ti.com/video">www.ti.com/video</a>

### TI E2E Community

[e2e.ti.com](http://e2e.ti.com)

# AMEYA360

## Components Supply Platform

Authorized Distribution Brand :



Website :

Welcome to visit [www.ameya360.com](http://www.ameya360.com)

Contact Us :

➤ Address :

401 Building No.5, JiuGe Business Center, Lane 2301, Yishan Rd  
Minhang District, Shanghai , China

➤ Sales :

Direct +86 (21) 6401-6692

Email [amall@ameya360.com](mailto:amall@ameya360.com)

QQ 800077892

Skype [ameyasales1](#) [ameyasales2](#)

➤ Customer Service :

Email [service@ameya360.com](mailto:service@ameya360.com)

➤ Partnership :

Tel +86 (21) 64016692-8333

Email [mkt@ameya360.com](mailto:mkt@ameya360.com)