



Surface Mount Silicon 5 Watt Zener Diodes

DESCRIPTION

The SMBJ5333B - SMBJ5388B series of surface mount 5.0 watt Zeners provides a selection from 3.3 to 200 volts with different tolerances as identified by suffix letter on the part number. It is equivalent to the JEDEC registered 1N5333 thru 1N5388B with identical electrical characteristics and testing. These parts are available with either Sn/Pb plating or a RoHS compliant matte-tin finish. This J-bend design (SMBJ) in the DO-214AA allows for greater PC board mounting density. These plastic encapsulated Zeners have a moisture classification of "Level 1" with no dry pack required. Microsemi also offers numerous other Zener products to meet higher and lower power applications.

Important: For the latest information, visit our website <http://www.microsemi.com>.

FEATURES

- Surface mount equivalent to JEDEC registered 1N5333 thru 1N5388 series.
- Ideal for high-density and low-profile mounting.
- Zener voltage available 3.3 V to 200 V.
- Plus/minus 10%, 5% and 2% voltage tolerances are available. (See [part nomenclature](#) block.)
- RoHS compliant versions available.

APPLICATIONS / BENEFITS

- Regulates voltage over broad operating current and temperature ranges.
- Wide selection from 3.3 to 200 V.
- Non-sensitive to ESD per MIL-STD-750 method 1020.
- Withstands high surge stresses.
- Minimal changes of voltage versus current.
- High specified maximum current (I_{ZM}) with adequate heat sinking.
- Moisture classification is "Level 1" per IPC/JEDEC J-STD-020B with no dry pack required.

MAXIMUM RATINGS

Parameters/Test Conditions	Symbol	Value	Unit
Junction and Storage Temperature	T_J and T_{STG}	-65 to +150	°C
Thermal Resistance Junction-to-Lead	$R_{\theta JL}$	25	°C/W
Thermal Resistance Junction-to-Ambient ⁽¹⁾	$R_{\theta JA}$	90	°C/W
Off-State Power Dissipation @ 25 °C ⁽²⁾	P_D	5.0	W
Forward Voltage @ 1.0 A	V_F	1.2	V
Solder Temperature @ 10 s	T_{SP}	260	°C

Notes: 1. When mounted on FR4 PC board (1oz Cu) with recommended footprint (see [pad layout](#)).
 2. 5 watts at $T_L \leq 25$ °C, or 1.38 watts at $T_A = 25$ °C when mounted on FR4 PC board with recommended footprint (also see [Figure 1](#)).

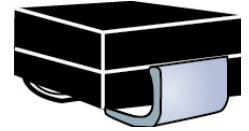

DO-214AA J-Bend Package

NOTE: All SMB series are equivalent to prior SMS package identifications.

Also available in:

DO-215AA Package

(Gull-wing surface mount)

 [SMBG5333 – SMBG5388](#)

T-18 Package

(axial-leaded)

 [1N5333 – 1N5388](#)

MSC – Lawrence

6 Lake Street,
Lawrence, MA 01841
Tel: 1-800-446-1158 or
(978) 620-2600
Fax: (978) 689-0803

MSC – Ireland

Gort Road Business Park,
Ennis, Co. Clare, Ireland
Tel: +353 (0) 65 6840044
Fax: +353 (0) 65 6822298

Website:

www.microsemi.com

MECHANICAL and PACKAGING

- CASE: Void-free transfer molded thermosetting epoxy body meeting UL94V-0.
- TERMINALS: C-bend (modified J-bend) tin-lead or RoHS compliant annealed matte-tin plating solderable per MIL-STD-750, method 2026.
- MARKING: Part number without SMBx prefix (e.g. 5334B, 5334Be3, MX5348C, 5376A, etc.).
- POLARITY: Cathode indicated by band. Diode to be operated with the banded end positive with respect to the opposite end.
- TAPE & REEL option: Standard per EIA-481-1-A with 12 mm tape (add "TR" suffix to part number). Consult factory for quantities.
- WEIGHT: 0.1 grams.
- See [Package Dimensions](#) on last page.

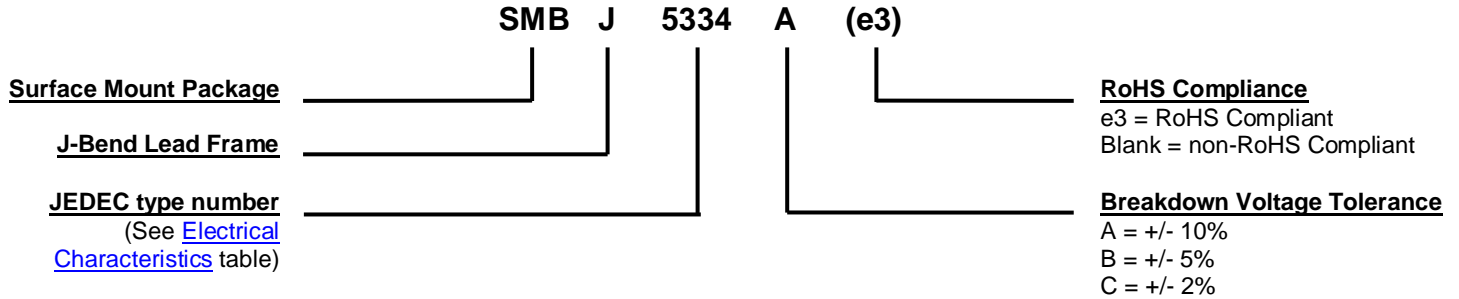
PART NOMENCLATURE

SYMBOLS & DEFINITIONS

Symbol	Definition
I_R	Reverse Current: The maximum reverse (leakage) current that will flow at the specified voltage and temperature.
I_Z, I_{ZT}, I_{ZK}	Regulator Current: The dc regulator current (I_Z), at a specified test point (I_{ZT}), near breakdown knee (I_{ZK}).
I_{ZM}	Maximum Regulator (Zener) Current: The maximum rated dc current for the specified power rating.
I_{ZSM}	Maximum Zener Surge Current: The non-repetitive peak value of Zener surge current at a specified wave form.
V_R	Reverse Voltage: The reverse voltage dc value, no alternating component.
V_Z	Zener Voltage: The Zener voltage the device will exhibit at a specified current (I_Z) in its breakdown region.
Z_{ZT} or Z_{ZK}	Dynamic Impedance: The small signal impedance of the diode when biased to operate in its breakdown region at a specified rms current modulation (typically 10% of I_{ZT} or I_{ZK}) and superimposed on I_{ZT} or I_{ZK} respectively.

ELECTRICAL CHARACTERISTICS @ $T_L = 30^\circ\text{C}$

TYPE NUMBER	REGULATOR VOLTAGE (V _Z)	TEST CURRENT (I _{ZT})	MAXIMUM DYNAMIC IMPEDANCE (Z _Z) (A & B suffix only)	MAXIMUM REVERSE CURRENT (I _R)	I _R TEST VOLTAGE (V _R) (A suffix only)	I _R TEST VOLTAGE (V _R) (B & C suffix only)	MAXIMUM REGULATOR CURRENT (I _{ZM}) (B & C suffix only)	MAXIMUM DYNAMIC KNEE IMPEDANCE Z _{ZK} @ 1.0 mA	MAXIMUM SURGE CURRENT (I _{ZSM})
	V	mA	Ohms	μA	V	V	mA	Ohms	Amps
SMBJ5333B	3.3	380	3.0	300	1.0	1.0	1440	400	20
SMBJ5334B	3.6	350	2.5	150	1.0	1.0	1320	500	18.7
SMBJ5335B	3.9	320	2.0	50	1.0	1.0	1220	500	17.6
SMBJ5336B	4.3	290	2.0	10	1.0	1.0	1100	500	16.4
SMBJ5337B	4.7	260	2.0	5.0	1.0	1.0	1010	450	15.3
SMBJ5338B	5.1	240	1.5	1.0	1.0	1.0	930	400	14.4
SMBJ5339B	5.6	220	1.0	1.0	2.0	2.0	865	400	13.4
SMBJ5340B	6.0	200	1.0	1.0	3.0	3.0	790	300	12.7
SMBJ5341B	6.2	200	1.0	1.0	3.0	3.0	765	200	12.4
SMBJ5342B	6.8	175	1.0	10	4.9	5.2	700	200	11.5
SMBJ5343B	7.5	175	1.5	10	5.4	5.7	630	200	10.7
SMBJ5344B	8.2	150	1.5	10	5.9	6.2	580	200	10
SMBJ5345B	8.7	150	2.0	10	6.25	6.6	545	200	9.5
SMBJ5346B	9.1	150	2.0	7.5	6.6	6.9	520	150	9.2
SMBJ5347B	10	125	2.0	5.0	7.2	7.6	475	125	8.6
SMBJ5348B	11	125	2.5	5.0	8.0	8.4	430	125	8.0
SMBJ5349B	12	100	2.5	2.0	8.6	9.1	395	125	7.5
SMBJ5350B	13	100	2.5	1.0	9.4	9.9	365	100	7.0
SMBJ5351B	14	100	2.5	1.0	10.1	10.6	340	75	6.7
SMBJ5352B	15	75	2.5	1.0	10.8	11.5	315	75	6.3
SMBJ5353B	16	75	2.5	1.0	11.5	12.2	295	75	6.0
SMBJ5354B	17	70	2.5	0.5	12.2	12.9	280	75	5.8
SMBJ5355B	18	65	2.5	0.5	13	13.7	264	75	5.5
SMBJ5356B	19	65	3.0	0.5	13.7	14.4	250	75	5.3
SMBJ5357B	20	65	3.0	0.5	14.4	15.2	237	75	5.1
SMBJ5358B	22	50	3.5	0.5	15.8	16.7	216	75	4.7
SMBJ5359B	24	50	3.5	0.5	17.3	18.2	198	100	4.4
SMBJ5360B	25	50	4.0	0.5	18	19	190	110	4.3
SMBJ5361B	27	50	5.0	0.5	19.4	20.6	176	120	4.1
SMBJ5362B	28	50	6.0	0.5	20.1	21.2	170	130	3.9
SMBJ5363B	30	40	8.0	0.5	21.6	22.8	158	140	3.7
SMBJ5364B	33	40	10	0.5	23.8	25.1	144	150	3.5
SMBJ5365B	36	30	11	0.5	25.9	27.4	132	160	3.3
SMBJ5366B	39	30	14	0.5	28.1	29.7	122	170	3.1
SMBJ5367B	43	30	20	0.5	31	32.7	110	190	2.8
SMBJ5368B	47	25	25	0.5	33.8	35.8	100	210	2.7
SMBJ5369B	51	25	27	0.5	36.7	38.8	93	230	2.5
SMBJ5370B	56	20	35	0.5	40.3	42.6	86	280	2.3
SMBJ5371B	60	20	40	0.5	43	45.5	79	350	2.2
SMBJ5372B	62	20	42	0.5	44.6	47.1	76	400	2.1
SMBJ5373B	68	20	44	0.5	49	51.7	70	500	2.0
SMBJ5374B	75	20	45	0.5	54	56	63	620	1.9
SMBJ5375B	82	15	65	0.5	59	62.2	58	720	1.8
SMBJ5376B	87	15	75	0.5	63	66	54.5	760	1.7
SMBJ5377B	91	15	75	0.5	65.5	69.2	52.5	760	1.6
SMBJ5378B	100	12	90	0.5	72	76	47.5	800	1.5
SMBJ5379B	110	12	125	0.5	79.2	83.6	43	1000	1.4
SMBJ5380B	120	10	170	0.5	86.4	91.2	39.5	1150	1.3
SMBJ5381B	130	10	190	0.5	93.6	98.8	36.6	1250	1.2
SMBJ5382B	140	8.0	230	0.5	101	106	34	1500	1.2
SMBJ5383B	150	8.0	330	0.5	108	114	31.6	1500	1.1
SMBJ5384B	160	8.0	350	0.5	115	122	29.4	1650	1.1
SMBJ5385B	170	8.0	380	0.5	122	129	28	1750	1.0
SMBJ5386B	180	5.0	430	0.5	130	137	26.4	1750	1.0
SMBJ5387B	190	5.0	450	0.5	137	144	25	1850	0.9
SMBJ5388B	200	5.0	480	0.5	144	152	23.6	1850	0.9

NOTE 1: Zener voltage (V_Z) is measured at T_L = 25 °C (+8, -2 °C). Voltage measurement to be performed 40 ±10 milliseconds after application of dc current.

NOTE 2: The Zener impedance is derived from 1 kHz ac voltage resulting from an ac current modulation having an rms value equal to 10% of the dc Zener current (I_{ZT} or I_{ZK}) superimposed on I_{ZT} or I_{ZK}. See [MicroNote 202](#) for Zener impedance variation with different operating currents.

NOTE 3: The maximum current (I_{ZM}) shown is for a ± 5% tolerance devices. The I_{ZM} for other tolerances can be calculated using the formula: I_{ZM} = P/V_{ZM} where V_{ZM} is the V_Z at the high end of the voltage tolerance specified and P is the rated power for the method of mounting.

NOTE 4: The surge current (I_{ZSM}) is specified as the maximum peak of a non-recurrent half-sine wave of 8.3 ms duration.

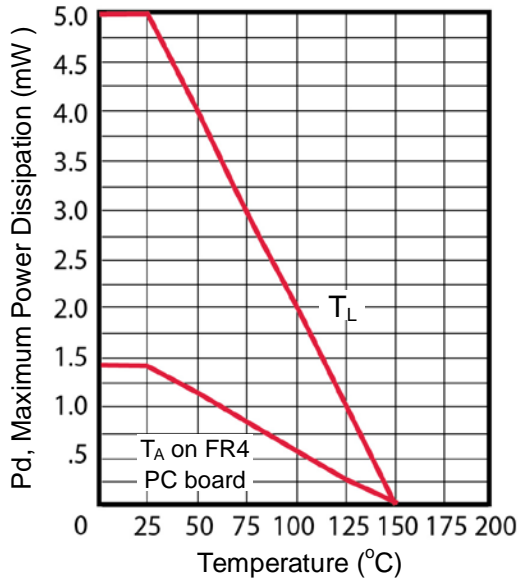
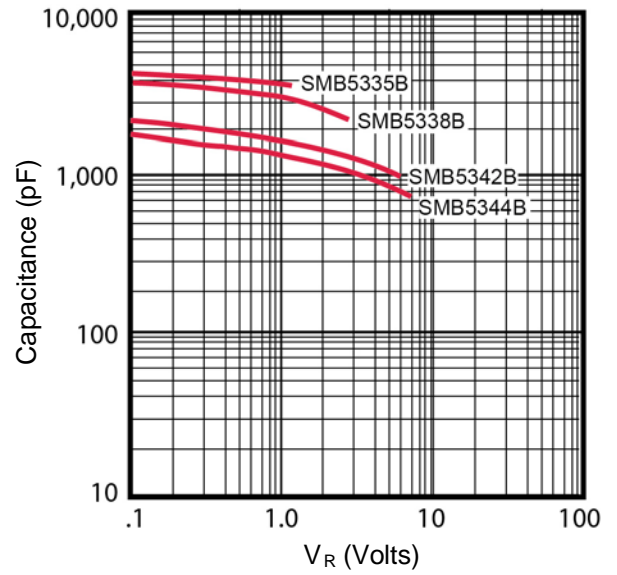
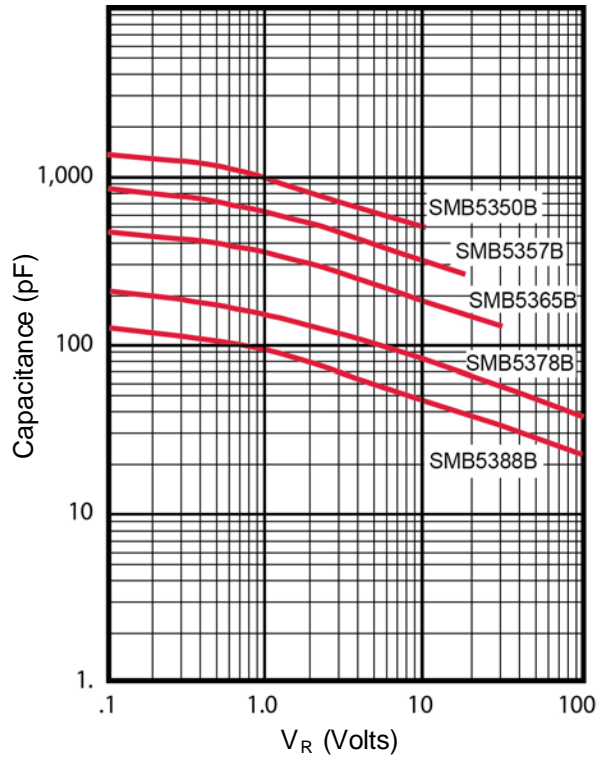
GRAPHS

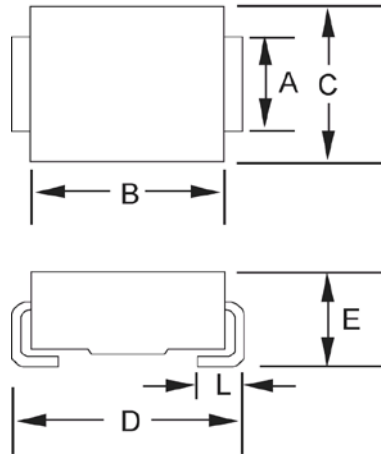
FIGURE 1 – Power Derating Curve

FIGURE 2 – Capacitance vs. Zener Voltage

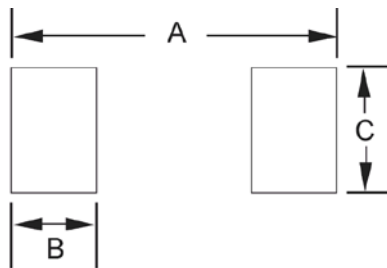
FIGURE 3 - Typical Capacitance vs. Reverse Voltage for 5 Watt Zeners

PACKAGE DIMENSIONS

Ltr	Dimensions			
	Inch		Millimeters	
	Min	Max	Min	Max
A	.077	.083	1.96	2.10
B	.160	.180	4.06	4.57
C	.130	.155	3.30	3.94
D	.205	.220	5.21	5.59
E	.077	.104	1.95	2.65
L	.030	.060	.760	1.52

PAD LAYOUT

	INCH	mm
A	.260	6.60
B	.085	2.16
C	.110	2.79

AMEYA360

Components Supply Platform

Authorized Distribution Brand :



Website :

Welcome to visit www.ameya360.com

Contact Us :

➤ Address :

401 Building No.5, JiuGe Business Center, Lane 2301, Yishan Rd
Minhang District, Shanghai , China

➤ Sales :

Direct +86 (21) 6401-6692

Email amall@ameya360.com

QQ 800077892

Skype [ameyasales1](#) [ameyasales2](#)

➤ Customer Service :

Email service@ameya360.com

➤ Partnership :

Tel +86 (21) 64016692-8333

Email mkt@ameya360.com