

A distributed automation system does not contain any central automated control cabinets. Controls, sensors and actuators are designed for a high degree of protection (IP 65 / IP 67) and are installed directly in the field. In connection with these innovative installation concepts with distributed devices, users are demanding a standard connector family that is compatible with all interfaces. In response to these needs, the HARTING PushPull series has set the respective new appliance connection standard. PushPull technology is available for data, signal and power applications. Other interfaces accommodating USB or fiber optics (LC, SCRJ) supplement the universal range of the PushPull solutions. The integration of communication and power lines in a hybrid PushPull connector is a genuine trend-setting advance. In view of these strengths, the PushPull container has become the standard for current and future appliance interfaces. The German automotive industry, for example, has opted for the implementation of the PushPull connector family.

*Application profile:*

CONNECTION TYPE		ENVIRONMENT		APPLICATION						
Board to Board	Cable/Wire to Board	IP 20	IP 65 / IP 67	Data	Signal	Power	high performance			
							Data transfer rate	Shielding	Number of contacts, contact density	Voltage, working current
Cable termination			PCB termination			Application standard				
<i>Han-Quick Lock®</i>	<i>IDC HARAX®</i>	<i>Crimp</i>	<i>THT</i>	<i>SMC</i>	<i>SMT</i>					
<i>Screw</i>	<i>Cage clamp</i>	<i>Axial screw</i>	<i>Press-in</i>			Housing integration				
						<i>Separate housing</i>	<i>Integrated housing</i>			

1) Piercing contacts

CONTENTS	PAGE
Introduction PushPull termination technology	02.02
HARTING PushPull type acc. to IEC 61 076-3-106 variant 4	
HARTING PushPull – housing bulkhead mounting for device integration	02.04
HARTING PushPull RJ45	02.05
HARTING PushPull LC duplex	02.09
HARTING PushPull Hybrid	02.11
HARTING PushPull Signal	02.15
HARTING PushPull USB	02.17
HARTING PushPull Power, 4-poles, 48 V (12 A)	02.20
HARTING PushPull Power, 3-poles, 250 V (16 A)	02.23
HARTING PushPull Power – Tooling and accessories	02.24
Han® PushPull type acc. to IEC 61 076-3-117 variant 14	
Han® PushPull RJ45	02.27
Han® PushPull SCRJ and tooling	02.43
Han® PushPull Signal	02.50
Han® PushPull Power 4/0, 5-poles, 230/400 V (16 A)	02.53
Han® PushPull Power 4/0 – Contacts and tooling	02.59
Han® PushPull Power L 4/0, 5-poles, 24 V (16 A)	02.61

The PushPull connector housing is a function container with degree of protection IP 65 / IP 67 and is available in two standardized housing sizes. These containers are equipped with standard RJ45, FOC or power contacts for operation at 5 x 16 A, depending on application requirements. The PushPull connector can be delivered either as plastic, or as metal variant, depending on the installation environment.

### THE PushPull PRINCIPLE

PushPull connector applications combine two basic advantages:

1. Simple operation
2. Safe and vibration resistant sealed IP 65 / IP 67 connection.

The innovative PushPull lock mechanism dispenses with the need for a latching bracket. The connector can be inserted with one hand, minimum force and an audible click for safe operation. The connection can be removed again just as easily for service work.

### COPPER, FOC AND POWER – IN THE SAME DESIGN

HARTING offers two series of the PushPull connector system, which differ in terms of their outer dimensions and module inserts.

#### Han® PushPull (IEC 61 076-3-117 VARIANT 14)

This series represents the standard PROFINET device interface for the IP 67 environment of the German automobile manufacturing industry.

The connector is available as metal and as plastic version. The RJ45 module for copper conductors and the SCRJ module for FOCs are available as data connectors. The RJ45 variant is realized by means of the RJ Industrial module equipped with HARAX® quick connection technology. The power module which is installed in the same container can be assembled on-site, either with crimp contacts or with innovative Quick Lock® technology in order to wire the distributed field devices to 230/400 V (16 A) power. This 5-pole connector enables the transfer of two



independent 24 V control circuits with functional ground, or the transfer of a three-phase voltage of 400 V (16 A).

### HARTING PushPull (IEC 61 076-3-106 VARIANT 4)

This extremely compact and space-saving series provides an Ethernet appliance connection with degree of protection IP 65 / IP 67 that requires no more installation space than a M12 connector. The RJ45 variant for copper conductors and the LC variant for FOCs are available as modules for data connectors. The RJ45 variant is realized by means of *HARAX*® quick connection technology as used with HARTING RJ Industrial®. The 4-pole module for 48 V (12 A) or the 3-pole module for 250 V (16 A) can be used to supply power to the distributed field devices.

### HARTING PushPull HYBRID

The migration from Fieldbus to Ethernet within communication technology has simplified machine installation options. This

simplification is attained by combining the data and the 24 V power lines in a single hybrid cable with hybrid connector, in connection with the spatial requirements of an M12 connector.

The HARTING PushPull Hybrid offers trend-setting connection technology for this new method of machine installation.

The PushPull Hybrid reduces everything by half: the number of connection points and cables, and spatial requirements for the connection technology.

The PushPull Hybrid makes everything easier: machine installation, the wiring of connectors and safe insertion.

### APPLIANCE INTEGRATION:

In order to support the implementation of appliances with degree of protection IP 65 / IP 67, HARTING offers panel feed-through devices with integrated couplings and female contact modules for direct mounting on PCBs.

PushPull

### HARTING PushPull

#### ONE CONCEPT FOR DATA, SIGNAL AND POWER

The internationally standardized PushPull connector represents the latest generation of appliance connection technology with high degree of protection IP 65 / IP 67, easy insertion and snap-action engagement with audible click.

The PushPull housing family is designed for the integration of a wide range of contact inserts for data, signal and power lines.



#### INSTALLATION IN PLANTS

##### WITH Han® PushPull CONNECTORS:

- The standard for PROFINET communication
- One housing for the electrical and optical data transfer and for power supply
- Plastic or metal housing variants



#### INSTALLATION IN MACHINES

##### WITH HARTING PushPull HYBRID CONNECTORS:

- Combined data lines and appliance power supply up to 5 A in the same connector
- Compact size (comparable with M12)
- Straight and angled connector design, suitable for on-site assembly and overmolded



#### POWER SUPPLY TO DISTRIBUTED DEVICES

##### USING PushPull CONNECTORS:

- Variant 4: 48 V (12 A), 4-pole or 250 V (16 A), 3-pole
- Variant 14: 400 V (12 A) 5-pole, or 24 V (16 A) 5-pole
- Latest connection technology QuickLock® for on-site assembly without special auxiliary tools









HARTING PushPull Technology acc. to IEC 61 076-3-106 variant 4 RJ45-connector

## Advantages

- Ethernet connector based on RJ45
- Fully shielded, 360° shielding contact
- Field-assembly connector with IDC contacts (Cat. 5 versions) or piercing contacts (Cat. 6 versions)

## Technical characteristics

Locking	PushPull Technology acc. to IEC 61 076-3-106 variant 4
Degree of protection	IP 65 / IP 67
Mating face	RJ45 acc. to IEC 60 603-7
Cable diameter	4.9 ... 8.6 mm
Termination cross section	
Cat. 5	AWG 24/7 ... AWG 22/7 (stranded) AWG 23/1 ... AWG 22/1 (solid)
Cat. 6	AWG 24/7 ... AWG 28/7 (stranded)
Mating cycles	min. 750
Temperature range	-40 °C ... +70 °C
Housing material	Plastic, black
Flammability acc. to UL 94	V 0
	UL approval (E102079)

Identification	Part No.	Drawing	Dimensions in mm
<b>Connector, 4-poles Cat. 5</b> incl. housing with RJ45 connector, shielding and cable gland	09 45 145 1100 09 45 195 1100 (metal version)		
<b>Connector, 8-poles Cat. 6</b> incl. housing with RJ45 connector, shielding and cable gland			
Wire manager white	09 45 145 1500 09 45 195 1500 (metal version)		
Wire manager blue	09 45 145 1510 09 45 195 1510 (metal version)		
<b>New Cat. 6<sub>A</sub> version</b> (available Q3/2012)	09 45 145 1520 09 45 195 1520 (metal version)	Reference note: For cat. 6 patch cords it is recommended to use one connector with a white wire manager and one with an blue cable manager, in order to optimise the crosstalk between different signal pairs.	
System cables in different versions		see catalogue "Intelligent Network Solutions"	



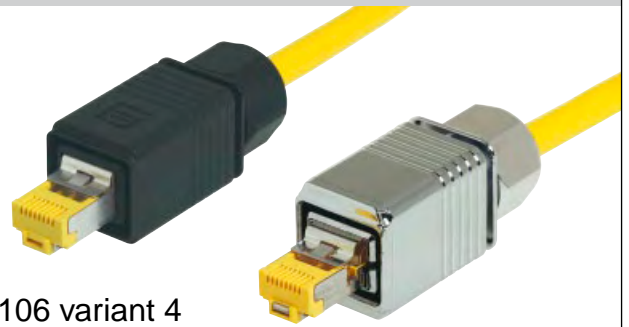

HARTING PushPull Technology acc. to IEC 61 076-3-106 variant 4 RJ45-connector

PushPull

## Advantages

- Ethernet connector based on RJ45
- Fully shielded, 360° shielding contact
- Field-assembly connector with IDC contacts
- Category of transmission: Cat. 6 / class E<sub>A</sub> suitable for 1/10 Gbit Ethernet

## Technical characteristics

Locking	PushPull Technology acc. to IEC 61 076-3-106 variant 4
Mating face	RJ45 acc. to IEC 60 603-7
Cable diameter	4.9 ... 8.6 mm
Termination cross section	AWG 27/7 ... AWG 22/7 (stranded) AWG 24/1 ... AWG 22/1 (solid)
Conductor diameter	max. 1.6 mm (incl. insulation)
Mating cycles	min. 750
Degree of protection	IP 65 / IP 67
Temperature range	-40 °C ... +70 °C
Housing material	Plastic, black
Flammability acc. to UL 94	V 0
	UL approval (E102079)

Identification	Part No.	Drawing	Dimensions in mm
----------------	----------	---------	------------------

Connector, 8-poles  
Cat. 6  
incl. housing with RJ45 connector,  
shielding and cable gland

09 45 145 1560  
09 45 195 1560  
(metal version)

Colour clips  
for colour coding the HARTING  
PushPull connectors

White	09 45 840 0011
Yellow	09 45 840 0013
Red	09 45 840 0017
Blue	09 45 840 0018
Green	09 45 840 0019

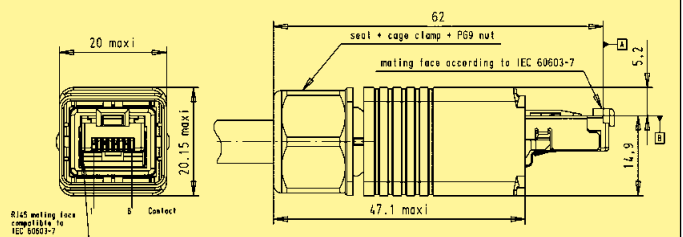

System cables in different versions

see catalogue "Intelligent Network Solutions"

# HARTING PushPull LC duplex



HARTING PushPull type acc. to IEC 61 076-3-106 variant 4  
LC duplex panel feed-through and connector

## Advantages

- Optical PushPull connector based on LC with small form factor (requires 50 % compared to SC and ST)
- EasyInstall and Compact panel feed-through for simple device integration
- Optical module with inserts acc. to IEC 61 754-20
- One-piece LC body assures high mechanical stability
- A & B parts identification for Duplex according TIA 568 standard

## Technical characteristics

Locking	PushPull Technology acc. to IEC 61 076-3-106 variant 4
Degree of protection	IP 65 / IP 67
Mating face	LC acc. to IEC 61 754-20
Cable diameter	5.8 ... 7.2 mm
Mating cycles	min. 200
Temperature range	-40 °C ... +70 °C
Housing material	Plastic, black
Flammability acc. to UL 94	V 0

Identification	Part No.	Drawing	Dimensions in mm
<b>HARTING PushPull LC duplex</b>			
Cable side			
Multimode GOF	09 57 402 0500 000		
(metal version)	09 57 409 0500 000		
Singlemode GOF	09 57 402 0501 000		
(metal version)	09 57 409 0501 000		
Device side EasyInstall version			
Multimode GOF	09 57 441 0500 000		
(metal version)	09 57 468 0500 000		
Singlemode GOF	09 57 441 0501 000		
(metal version)	09 57 468 0501 000		
Device side Compact version			
Multimode GOF	09 57 442 0502 001		
Singlemode GOF	09 57 442 0503 001		



LC duplex IP 20 adapter for device integration

## Advantages

- Small form factor requires 50 % (compared to SC and ST)
- Compact, space-saving design
- High packing density
- A & B parts identification according TIA 568 standard
- Complement adapter for IP 67 connector on device side

## Technical characteristics

Degree of protection	IP 20
Mating interface	LC duplex with two fibres
Temperature range	-40 °C ... +70 °C

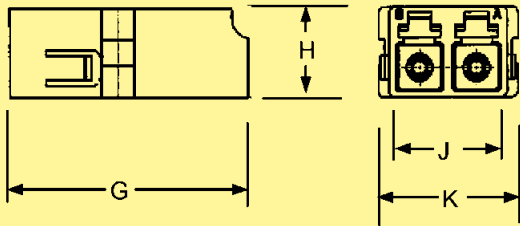
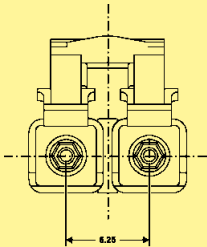
Identification	Part No.	Drawing	Dimensions in mm
Device side			
Adapter			
Multimode GOF	09 57 400 0003 000		
Singlemode GOF	09 57 400 0004 000		
Connector LC duplex			
Multimode GOF	09 57 400 0001 000		
Singlemode GOF	09 57 400 0002 000		

	min.	max.
G	26.60	26.80
H	9.35	9.45
J	12.80	12.90
K	15.24	15.34

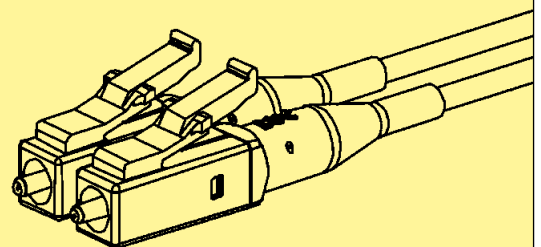



HARTING PushPull Hybrid  
type acc. to IEC 61 076-3-106 variant 4

## Advantages

### HARTING PushPull Hybrid

In the future all new machine generations will be equipped with Fast Ethernet, no matter if PROFINET, Ethernet/IP, Powerlink, Ethercat, Varan or other Ethernetprofiles.

With the change of the communication technology also the possibility is offered of simplifying the machine installation and of introducing an innovative Hybrid installation concept. This simplification will unite by data and 24 V (5 A)-supply in a Hybrid cable, at least with the space requirement of a M12-connector.

For this new installation solution HARTING with the HARTING PushPull Hybrid offers the trend-setting installation technology.

Everything is halved: the number of pluggings, the number of cables and the space requirement for the connection technology. Everything becomes simpler: the installation, attaching and safe plugging.

The Hybrid connectors were developed particular under the criteria of simple attaching in the field and the particular safe data communication with the patented omega screen concept. As contacts D-Sub and HDD Sub contacts worked world-wide are used. This socket pin contact system ensures highest reliability and optimal shock and vibration stability.

With the optional available coding pins 6 different codings can be realized.

This connector is available in the variants straight or angled as well as for field assembling or overmolded.

## Technical characteristics

### Advantages

- Compact, space-saving design
- Very compact housing with high degree of protection
- Polarisation with nose
- Sixfold codable

### Typical application areas

- Factory and building automation
- Industrial electronics
- Telecommunication and wireless networks
- Transportation
- Industrial monitoring and camera systems
- Lighting and display technology
- Access control systems

### Recommended pin assignment

- Power contacts

Contact	Function	Conductor colour
1	V +	Red
2	Ground	Brown
3	V + (switched)	Yellow

- Data contacts

Contact	Signal	Function	Conductor colour
4	RD -	Receiver Data -	Blue
5	RD +	Receiver Data +	White
6	TD -	Transmission Data -	Orange
7	TD +	Transmission Data +	Yellow



Structure Hybrid cable  
Data: 4x AWG26/7  
Power: 3x AWG20/7



HARTING PushPull Hybrid, type acc. to IEC 61 076-3-106 variant 4 device side

PushPull

## Advantages

- Combined data- and power-supply up to 5 A / 48 V included to one connector
- HARTING PushPull technology
- Compact design
- High packing density
- Sixfold codable
- Suitable for all Fast-Ethernet variants

## Technical characteristics

Locking	PushPull Technology acc. to IEC 61 076-3-106 variant 4
Degree of protection	IP 65 / IP 67
Termination	Solder pins
Transmission performance	Category 5 / Class D up to 100 MHz acc. to ISO/IEC 11 801:2002, EN ISO 50 173-1
Transmission rate	10 / 100 Mbit/s
Number of contacts	Data: 4, shielded (Ethernet) Power: 3, (5 A / 48 V)
Housing material	Plastic, black
Flammability acc. to UL 94	V 0

### Identification

### Part No.

### Drawing

### Dimensions in mm

#### Components device side

##### Set straight

HARTING PushPull Hybrid housing bulkhead mounting and pcs female shielded, IP 65 / IP 67, black, 180° straight

09 45 245 1300

##### Set angled

HARTING PushPull Hybrid housing bulkhead mounting and pcs female shielded, IP 65 / IP 67, black, 90° angled

09 45 245 1310

##### Female insert

PCB jack shielded 180° straight

09 45 545 1300

PCB jack shielded 90° angled

09 45 545 1305

##### Housing bulkhead mounting

for female insert straight

09 45 545 1320

for female insert angled

09 45 545 1325

##### Panel feed-through

1 x Hybrid female IP 65 / IP 67 on  
1 x RJ45 female and 3 pcb clamps,  
board drillings for M2.5

09 45 245 1320

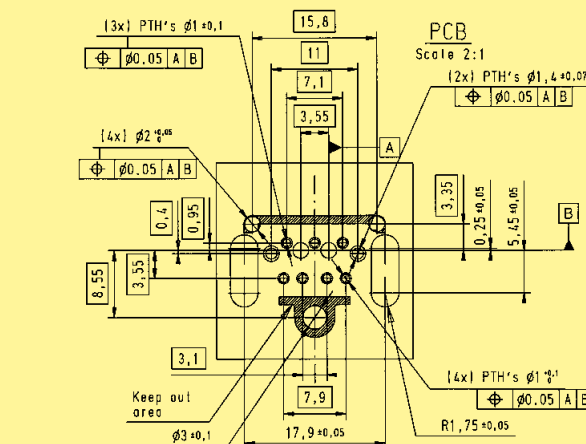
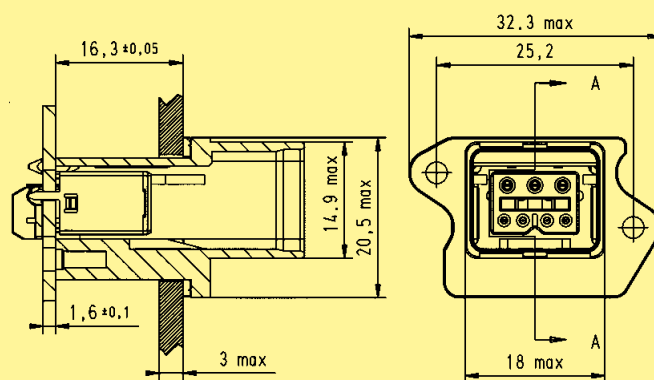



HARTING PushPull Hybrid, type acc. to IEC 61 076-3-106 variant 4  
Hybrid connector

## Advantages

- Combined data- and power-supply up to 5 A / 48 V included to one connector
- HARTING PushPull technology
- Compact design
- High packing density
- Sixfold condable
- Suitable for all Fast-Ethernet variants

## Technical characteristics

Locking	PushPull Technology acc. to IEC 61 076-3-106 variant 4
Degree of protection	IP 65 / IP 67
Termination	Crimp
Cable diameter	AWG 26 for Ethernet AWG 20 for Power
Transmission performance	Category 5 / Class D up to 100 MHz acc. to ISO/IEC 11 801:2002, EN ISO 50 173-1
Number of contacts	Data: 4, shielded (Ethernet) Power: 3, (5 A / 48 V)
Housing material	Plastic, black
Flammability acc. to UL 94	V 0

Identification	Part No.	Drawing	Dimensions in mm
<b>Connector</b> HARTING PushPull Hybrid connector, IP 65/ 67, black, with cable gland and crimp contacts  straight	09 45 145 1300		
<b>Accessories – Coding pin set</b> to avoid accidental incorrect mating a coding system is required. This coding pins are inserted without loss of contact.	09 45 845 1300		
<b>Tools</b> Crimping tool for data contacts	09 99 000 0596		
Crimping tool for power contacts	09 99 000 0175		
<b>Insertion and removal tool</b> for data contacts	09 99 000 0513		
for power contacts	09 99 000 0171		



HARTING PushPull Hybrid, type acc. to IEC 61 076-3-106 variant 4 overmoulded Hybrid system cables

PushPull

## Advantages

- Combined data- and power-supply up to 5 A / 48 V included to one connector
- HARTING PushPull technology
- Robust design, suitable for industrial applications
- High packing density
- Sixfold codable
- Suitable for all Fast-Ethernet variants

## Technical characteristics

Cable construction:	Twisted Pair shielded + 3 Power cables
Core structure	Data: 4x AWG 26/7 Power: 3x AWG 20/7
Transmission performance	Category 5 / Class D up to 100 MHz acc. to ISO/IEC 11801:2002, EN ISO 50173-1
Sheath material	FRNC
Cable-outer diameter	ø (7.0 ±0.4) mm
Shielding	Shielding foil and shielding braid
Temperature range	-40 °C ... +80 °C
Colour	black

Identification	Part No.	Drawing	Dimensions in mm
----------------	----------	---------	------------------

### System cables 2x HARTING PushPull Hybrid

Length	0.5 m	09 47 616 1005
	1 m	09 47 616 1010
	2 m	09 47 616 1020
	3 m	09 47 616 1030
	5 m	09 47 616 1050
	10 m	09 47 616 1100
	20 m	09 47 616 1200

### System cables 1x HARTING PushPull Hybrid, second side open

Length	0.5 m	09 47 610 0005
	1 m	09 47 610 0010
	2 m	09 47 610 0020
	3 m	09 47 610 0030
	5 m	09 47 610 0050
	10 m	09 47 610 0100
	20 m	09 47 610 0200

### Hybrid cable

ring	20 m	09 45 600 0331
ring	50 m	09 45 600 0341
ring	100 m	09 45 600 0301
reel	500 m	09 45 600 0321



Structure Hybrid cable

available  
Q3 / 2012



HARTING PushPull, type acc. to IEC 61 076-3-106 variant 4  
10-poles 100 V / 5 A

## Features

- HARTING PushPull technology
- For the transmission of analog, low voltage and bus signals
- Fully shielded
- 10 contacts
- Touch-proof
- Easy and fast cable installation

## Technical characteristics

Locking	PushPull technology acc. to IEC 61 076-3-106 variant 4
Degree of protection	IP 65 / IP 67
Mating face	acc. to IEC/PAS 61076-3-11x
Number of contacts	10
Electrical data acc. to DIN EN 61984	5 A 100 V 1.5 kV 3
Contact resistance	10 mΩ
Termination	Crimp
Conductor cross section	0.75 mm <sup>2</sup>
Conductor diameter	max. 2.1 mm
Outer cable diameter	6.5 ... 9.5 mm
Shielding	Fully shielded, 360° shielding contact
Mating cycles	min. 500
Temperature range	-40 °C ... +70 °C
Housing material	Plastic, black Zinc die-cast, nickel-plated
Flammability acc. to UL 94	V 0

Identification

Part No.

Drawing

Dimensions in mm

### HARTING PushPull Signal

Connector set 10-poles  
incl. plastic housing  
and female insert

09 45 145 9010

Order D-Sub crimp female  
contacts separately

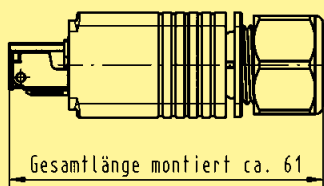

total length assembled of approx. 61

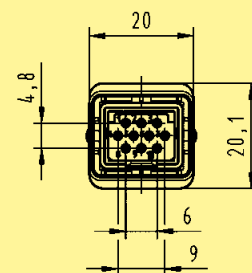

PushPull



Identification

Part No.

Drawing

Dimensions in mm

## HARTING PushPull Signal

Insert for panel feed-through  
HIFF, 10-poles  
incl. male insert

09 45 545 9010

Order D-Sub crimp male  
contacts separately

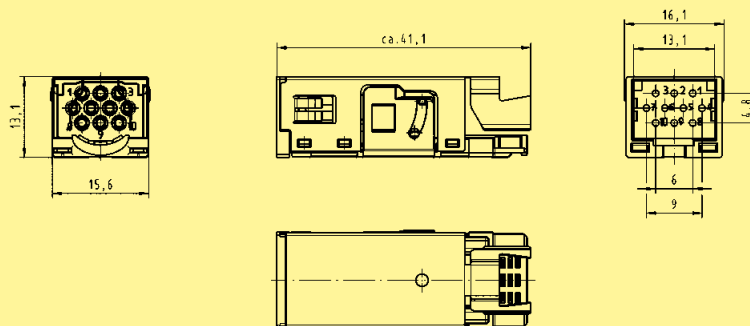

## HARTING PushPull

housing bulkhead mounting,  
plastic

EasyInstall

09 45 545 0032

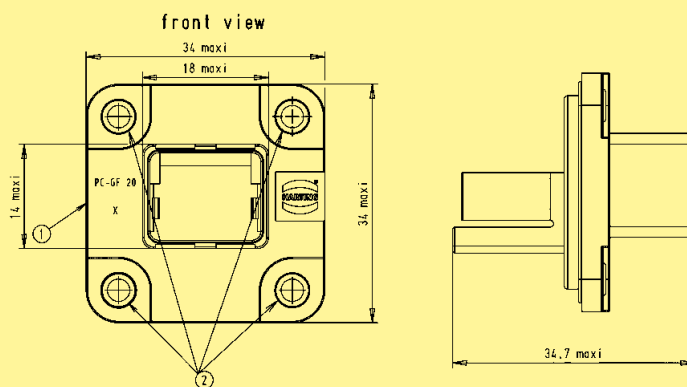

Compact

09 45 545 0028

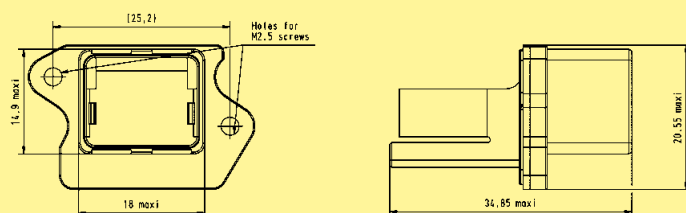

## D-Sub crimp contacts

(Female)

for AWG 24-20; 0.25-0.56 mm<sup>2</sup>

09 67 000 8278<sup>1)</sup>

for AWG 22-18; 0.33-0.82 mm<sup>2</sup>

09 67 000 3476<sup>2)</sup>

(Male)

for AWG 24-20; 0.25-0.56 mm<sup>2</sup>

09 67 000 8178<sup>1)</sup>

for AWG 22-18; 0.33-0.82 mm<sup>2</sup>

09 67 000 3576<sup>2)</sup>

<sup>1)</sup> To be used with crimp tool 09 99 000 0175

<sup>2)</sup> To be used with crimp tool 09 99 000 0501. Suitable locator: 61 03 600 0531

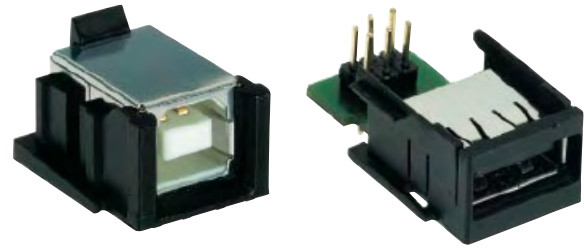

HARTING PushPull USB  
Components device side and panel feed-throughs

## Advantages

- HARTING PushPull technology
- Compact, space-saving design for the device integration of USB jacks
- USB 2.0 and 3.0 compatible

## Technical characteristics

Mating face	USB 2.0 type B and USB 2.0 / 3.0 type A
Number of contacts	USB 2.0: 4 and USB 3.0: 9
Degree of protection	IP 65 / IP 67
Mating cycles	min. 750
Temperature range	-40 °C ... +70 °C

Identification	Part No.	Drawing	Dimensions in mm
<p>Components device side</p> <p>USB 2.0 type B Solder jack, angled 90°, THT</p>	09 45 541 1900		
<p>Adapter PCB USB 2.0 type A Jack to pin header</p>	09 45 541 1902		
<p>Adapter PCB USB 3.0 type A Jack to pin header</p>	09 45 541 1905		

All solder jacks and adapter PCB's are suitable for the HARTING PushPull bulkhead mounting housings  
09 45 545 0021 / ... 0023 / ... 0029 / ... 0030 / ... 0031 / ... 0033 (see page 02.04)

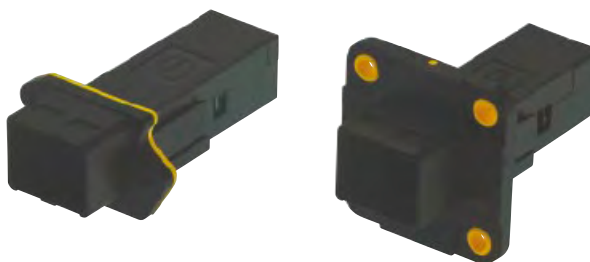

## HARTING PushPull USB Panel feed-throughs

### Advantages

- HARTING PushPull technology
- Compact, space-saving design for the device integration of USB jacks
- USB 2.0 and 3.0 compatible

### Technical characteristics

Mating face	USB 2.0 / 3.0 type A
Number of contacts	USB 2.0: 4 and USB 3.0: 9
Degree of protection	IP 65 / IP 67
Mating cycles	min. 750
Temperature range	-40 °C ... +70 °C

Identification      Part No.      Drawing      Dimensions in mm

#### Panel feed-throughs

##### EasyInstall style

USB 2.0 type A  
2 x jack

09 45 245 1903

USB 3.0 type A  
2 x jack

09 45 245 1905

##### Compact style

USB 2.0 type A  
2 x jack

09 45 245 1902

USB 3.0 type A  
2 x jack

09 45 245 1904

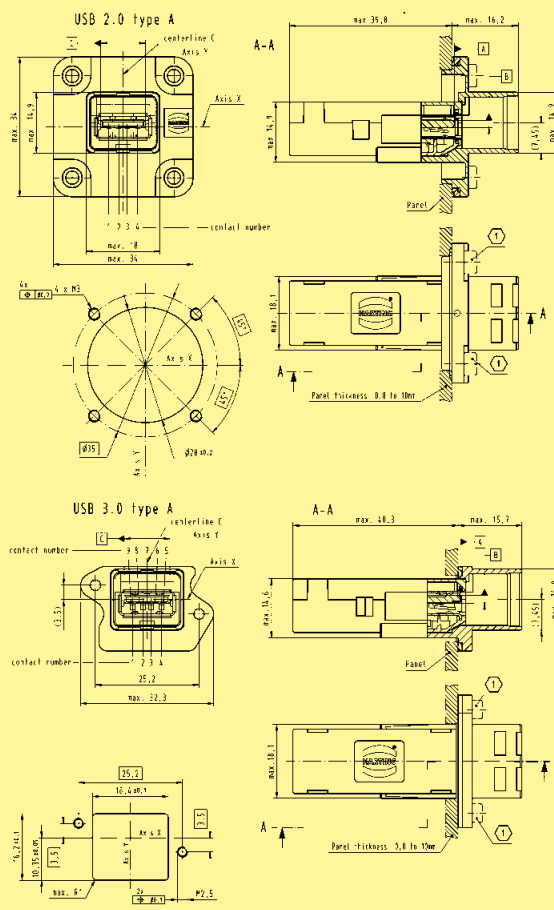



HARTING PushPull USB System cables

## Advantages

- HARTING PushPull technology
- Compact, space-saving design for the device integration of USB jacks
- USB 2.0 and 3.0 compatible
- Fully shielded, 360° shielding contact
- Robust design, suitable for industrial applications

## Technical characteristics

Mating face	USB 2.0 type B and USB 2.0 / 3.0 type A
Number of contacts	USB 2.0: 4 and USB 3.0: 9
Degree of protection	IP 65 / IP 67
Mating cycles	min. 750
Temperature range	-40 °C ... +70 °C

Identification	Part No.	Drawing	Dimensions in mm
----------------	----------	---------	------------------

**System cables**  
2 x PushPull USB  
Length 1.5 m

USB 2.0 type B

09 45 145 3902

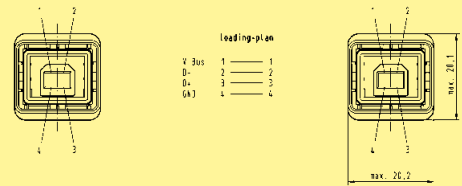

USB 2.0 type A

09 45 145 1902



USB 3.0 type A

09 45 145 2902

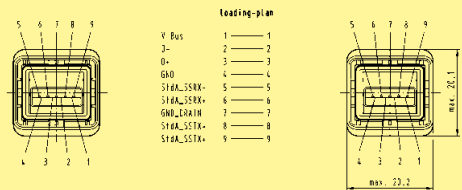

**System cables**  
1 x PushPull USB  
1 x IP 20 USB  
Length 1.5 m

USB 2.0 type B

09 45 145 3912



USB 2.0 type A

09 45 145 1912

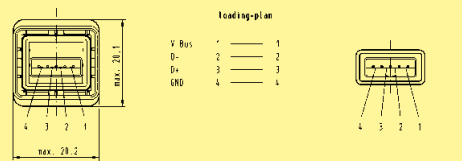

USB 3.0 type A

09 45 145 2912

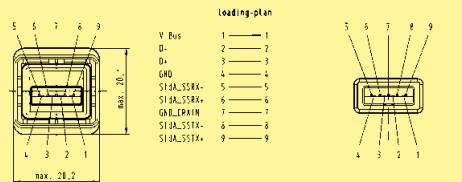

Other types and lengths on request

HARTING offers with the HARTING PushPull Power connector an universal solution for the power supply in compact and robust applications. It is in its element wherever small dimensions are combined with a high protection class.

The connector is available in a 4-pole 48 V and a 2-pole 250 V version. The power contacts can carry up to 12 resp. 16 A each (see deratings). In spite of this high current carrying capacity the connector gets by with minimal dimensions and fulfils the industrial requirements for clearances and creepage distances at the same time (pollution degree 3 and overvoltage category III).

Additionally the HARTING PushPull Power connector offers the protection class of IP 67 and 65. Beside numerous industrial use cases it is thereby suited for diverse applications in the fields of transportation and telecommunication.

The cable side of the HARTING PushPull Power is terminated with crimping technology. For the receptacle several solutions with different termination technologies are offered.

- Regulations**
- VDE 0110
  - DIN EN 61984

**Advantages**

- Minimum space requirements in spite of high current carrying capacity
- Very compact housing in a high protection class
- Protection against contact on plug AND receptacle side enables an easy and safe installation
- For low voltage (48 V) and for power supply (250 V) available
- Codeable without losing contacts
- Different termination technologies for individual device integration

**Typical application areas**

- Factory and building automation
- Industrial electronics
- Telecommunication and wireless networks
- Transportation
- Industrial monitoring and camera systems
- Lighting and display technology
- Access control systems

**Current carrying capacity**

The current carrying capacity is determined in tests which are conducted on the basis of the DIN IEC 60512-5-2. The current carrying capacity is limited by the thermal properties of materials which are used for inserts as well as by the insulating materials. These components have a limiting temperature which should not be exceeded.

**Example of a current capacity curve**

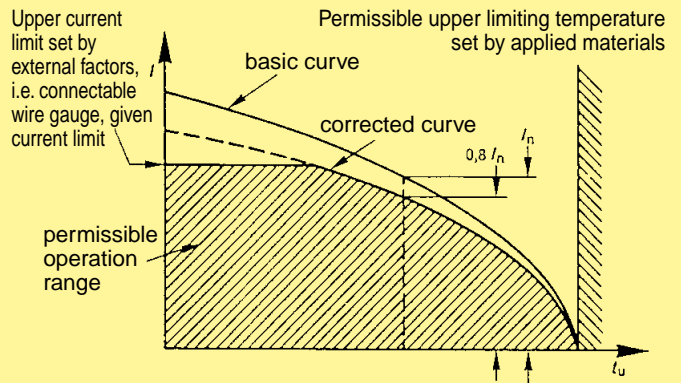

Derating-Diagramm for low voltage, 48 V; 4x 12 A

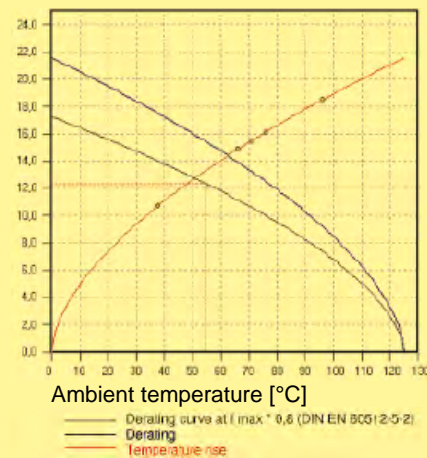

Derating-Diagramm for power supply, 250 V; 2x 16 A

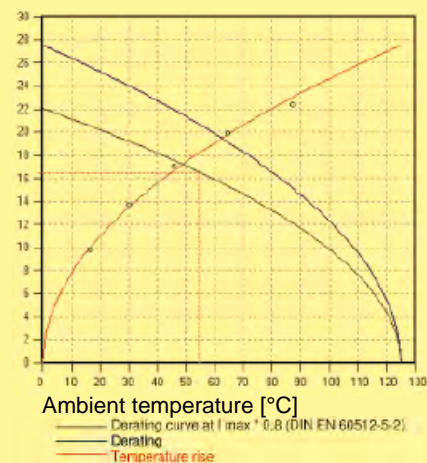



HARTING PushPull Power 4/0, type acc. to IEC 61 076-3-106 variant 4 panel feed-throughs 4-poles 48 V / 12 A

## Advantages

- Power connectors for devices
- EasyInstall and Compact panel feed-through and females for simple device integration
- Compact, space-saving design
- Touch-proof according to IEC DIN EN 60 529
- Polarisation with nose
- Device side: female with cable cage, crimp or solder termination
- 4 different coding variants without loss of contact

## Technical characteristics

Locking	PushPull Technology acc. to IEC 61 076-3-106 variant 4
Degree of protection	IP 65 / IP 67
Number of contacts	4
Electrical data acc. to EN 61 984	12 A 48 V 1.5 kV 3
Termination	Crimp
Termination cross section	0.75 - 2.5 mm <sup>2</sup> (AWG 20 - 12) stranded
Termination	Solder pins
Termination diameter	1.6 mm
Termination	Cable cage
Termination cross section	0.75 - 2.5 mm <sup>2</sup> (AWG 20 - 12) stranded
Mating cycles	min. 750
Temperature range	-40 °C ... +70 °C
Housing material	Plastic, black
Flammability acc. to UL 94	V 0

Identification	Part No.	Drawing	Dimensions in mm
<b>Panel feed-through set</b>			
<b>Housing bulkhead mounting EasyInstall</b> with 4 turned female contacts and insulation body with crimp termination for 1.5 mm <sup>2</sup> with solder termination, 90° angled with cage clamp terminal on pcb	09 46 245 4430 09 46 295 4430 <sup>1)</sup> 09 46 245 4030 09 46 295 4030 <sup>1)</sup> 09 46 245 4031 09 46 295 4031 <sup>1)</sup>		
<b>Housing bulkhead mounting Compact</b> with 4 turned female contacts and insulation body with crimp termination for 1.5 mm <sup>2</sup> with solder termination, 90° angled with cage clamp terminal on pcb	09 46 245 4400 09 46 245 4000 09 46 245 4001		
<b>Power-female with solder termination</b> 4-poles, 48 V / 12 A, 90° angled 4-poles, 48 V / 12 A, 90° straight	09 46 500 4400 09 46 500 4402		
<b>Power-female with crimp termination</b>	09 46 500 4401		

Panel cut outs see page 02.04  
<sup>1)</sup> Metal version (without contacts)



HARTING PushPull Power 4/0, type acc. to IEC 61 076-3-106 variant 4  
connector 4-poles 48 V / 12 A

PushPull

## Advantages

- Power connectors for devices
- EasyInstall panel feed-through for simple device integration
- Compact, space-saving design
- Touch-proof according to IEC DIN EN 60 529
- Polarisation with nose
- Cable side: Male with crimp termination
- 4 different coding variants without loss of contact

## Technical characteristics

Locking	PushPull Technology acc. to IEC 61 076-3-106 variant 4
Degree of protection	IP 65 / IP 67
Number of contacts	4
Electrical data acc. to EN 61 984	12 A 48 V 1.5 kV 3
Cable diameter	4.9 ... 8.6 mm
Termination	Crimp
Termination cross section	0.75 - 2.5 mm <sup>2</sup> (AWG 20 - 12) stranded
Mating cycles	min. 750
Temperature range	-40 °C ... +70 °C
Housing material	Plastic, black
Flammability acc. to UL 94	V 0

Identification	Part No.	Drawing	Dimensions in mm
----------------	----------	---------	------------------

### Connector set

incl. 4 turned crimp contacts (male)  
for 1.5 mm<sup>2</sup>, insulation body, housing,  
cable gland

09 46 145 4400  
09 46 195 4400<sup>1)</sup>

### Connector set

without contacts

09 46 145 4401

### Accessories – crimp contacts male

0.75 mm<sup>2</sup> (AWG 20 - 18)

09 46 500 0403

1.5 mm<sup>2</sup> (AWG 16 - 14)

09 46 500 0401

2.5 mm<sup>2</sup> (AWG 12)

09 46 500 0405

### Accessories – crimp contacts female

0.75 mm<sup>2</sup> (AWG 20 - 18)

09 46 500 0404

1.5 mm<sup>2</sup> (AWG 16 - 14)

09 46 500 0402

2.5 mm<sup>2</sup> (AWG 12)

09 46 500 0406

### Accessories – Coding pin set

to avoid accidental incorrect mating  
a coding system is required.

09 46 840 0000

This coding pins are inserted without  
loss of contact.

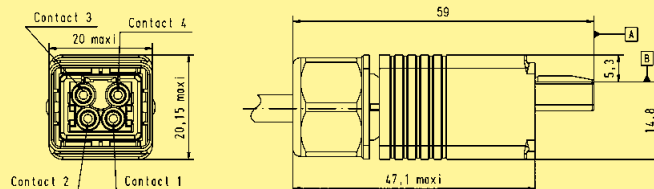

<sup>1)</sup> Metal version (without contacts)



HARTING PushPull Power 2/0, type acc. to IEC 61 076-3-106 variant 4 panel feed-through and connector, 3-poles, 250 V / 16 A

## Advantages

- Power connectors for devices
- EasyInstall panel feed-through for simple device integration
- Compact, space-saving design
- Touch-proof according to IEC DIN EN 60 529
- Polarisation with nose
- Cable side: Male with crimp termination
- Device side: female with crimp termination
- 4 different coding variants without loss of contact

## Technical characteristics

Locking	PushPull Technology acc. to IEC 61 076-3-106 variant 4
Degree of protection	IP 65 / IP 67
Number of contacts	2 + PE
Electrical data acc. to EN 61 984	16 A 250 V 4 kV 3
Cable diameter	4.9 ... 8.6 mm
Termination	Crimp
Termination cross section	0.75 - 2.5 mm <sup>2</sup> (AWG 20 - 12) stranded
Mating cycles	min. 750
Temperature range	-40 °C ... +70 °C
Housing material	Plastic, black
Flammability acc. to UL 94	V 0

Identification	Part No.	Drawing	Dimensions in mm
<b>HARTING PushPull Power 2/0</b>			
<b>Panel feed-through set</b> incl. 3 turned crimp contacts (female) for 1.5 mm <sup>2</sup> , insulation body (black), housing bulkhead mounting EasyInstall	09 46 245 3430		
<b>Panel feed-through set</b> incl. 3 turned contacts (female) for 1.5 mm <sup>2</sup> , insulation body (black), housing bulkhead mounting, with crimp termination	09 46 245 3410		
<b>Power-female with crimp termination</b> without contacts	09 46 500 3401		
<b>Connector set</b> incl. 3 turned crimp contacts (male) for 1.5 mm <sup>2</sup> , insulation body (black), housing, cable gland	09 46 145 3410		
<b>Connector set</b> without contacts	09 46 145 3411		
<b>Coding pin set</b> to avoid accidental incorrect mating a coding system is required. This coding pins are inserted without loss of contact.	09 46 840 0000		



Identification	Part No.
HARTING PushPull Power 8-indent crimping tool incl. positioner	09 46 800 0000
Locator HARTING PushPull Power contacts for Buchanan crimping tool (09 99 000 0001)	09 46 800 0010
Insertion tool	09 46 800 0099
Extraction tool	09 46 800 0098



For wire gauges  
0.08 ... 4.0 mm<sup>2</sup>  
(AWG 28 ... 12).



For an easy insertion and  
extraction of the male and  
female crimp contacts into /  
out of the insulator body.

### Crimp connection

A perfect crimp connection is gastight, therefore corrosion free and amounts to a cold weld of the parts being connected. For this reason, major features in achieving high quality crimp connections are the design of the contact crimping parts and of course the crimping tool itself. Wires to be connected must be carefully matched with the correct size of crimp contacts. If these basic requirements are met, users will be assured of highly reliable connections with low contact resistance and high resistance to corrosive attack.

The economic and technical advantages are:

- Constant contact resistance as a result of precisely repeated crimp connection quality
- Corrosion free connections as a result of cold weld action
- Pre-preparation of cable forms with crimp contacts fitted
- Optimum cost cable connection

Requirements for crimp connectors are laid down in DIN IEC 60352-2, Amend. 2, as illustrated in the table.

#### Pull out force of stranded wire

The main criterion to judge the quality of a crimp connection is the retention force achieved by the wire conductor in the terminal section of the contact. DIN IEC 60352, part 2, defines the extraction force in relation to the cross-section of the conductor. When fitted using HARTING crimping tools and subject to their utilization in an approved manner, our crimp connectors comply with the required extraction forces.

### Tensile strength of crimped connections

Conductor cross-section		Tensile strength
mm <sup>2</sup>	AWG	N
0.08	28	11
0.12	26	15
0.14		18
0.22	24	28
0.25		32
0.32	22	40
0.5	20	60
0.75		85
0.82	18	90
1.0		108
1.3	16	135
1.5		150
2.1	14	200
2.5		230
3.3	12	275
4.0		310

Extract from DIN IEC 60352-2, Amend. 2, Table IV

### Crimping tools

Crimping tools (hand operated or automatic) are carefully designed to produce with high pressure forming parts a symmetrical connection of the crimping part of the contact and the wire being connected with the minimum increase in size at the connection point. The positioner automatically locates the crimp and wire at the correct point in the tool.

A ratchet in the tool performs 2 functions:

- ① It prevents insertion of the crimp into the tool for crimping before the jaws are fully open
- ② It prevents the tool being opened before the crimping action is completed



Crimp-cross section  
HARTING crimp profile

Identical, perfectly formed, connections can be produced using this crimping system.

Identification	Part No.	Drawing	Dimensions in mm
<b>Transport protection</b> for device side IP 40	09 45 845 0003		max. 10
<b>Protection cover</b> for device side IP 65 / IP 67			
Version with passive locking without cord	09 45 845 0009 024		
Version with passive locking with plastic cord for fixing screw M3	09 45 845 0009		
Version with passive locking with nylon cord for fixing screw M2.5 / M3	09 45 845 0011 024		
Version with active locking without cord	09 45 845 0015		
Version with active locking with plastic cord for fixing screw M3	09 45 845 0014		
Version with active locking with nylon cord for fixing screw M2.5 / M3	09 45 845 0013		
<b>Protection cover</b> for connectors IP 65 / IP 67	09 45 845 0010		
<b>Security clip</b> for connectors can be sealed and protects against unauthorized unplugging	09 45 845 0020		

available  
Q2 / 2012



HARTING PushPull, type acc. to IEC 61 076-3-106 variant 4  
cable to cable housing

### Features

- HARTING PushPull technology
- Ideal for prototyping
- Can be combined with panel feed-throughs for power, data and signal

### Technical characteristics

Locking	PushPull technology acc. to IEC 61 076-3-106 variant 4
Degree of protection	IP 65 / IP 67
Outer cable diameter	6.5 ... 9.5 mm
Mating cycles	min. 750
Temperature range	-40 °C ... +70 °C
Housing material	Plastic, black
Flammability acc. to UL 94	V 0

Identification	Part No.	Drawing	Dimensions in mm
<b>HARTING PushPull cable to cable housings, plastic</b> (Order housing bulkhead mounting and insert separately)  for outer cable diameter 6.5 ... 9.5 mm	09 45 345 0000	2X M2.5x10 self tapping screws according to EN ISO 7092 	
<b>HARTING PushPull bulkhead housings, plastic</b> (Order housing bulkhead mounting and insert separately)	09 45 345 0001	2X M2.5x10 self tapping screws according to EN ISO 7092 	
<b>Suitable HARTING PushPull Signal panel feed-through</b>	09 45 245 9010		
<b>Suitable bulkhead housing, plastic</b> for RJ45 / Signal	09 45 545 0028		
<b>Inserts for RJ45 / Signal</b>  RJ 45: 8-poles, Cat. 6 / class E <sub>A</sub> Ha-Vis preLink® set AWG 22/23	20 82 001 0001		
HARTING RJ Industrial® cable jack with IDC termination AWG 22-24, 8-poles	09 45 545 1562		
AWG 24-28, 8-poles	09 45 545 1561		
AWG 22-24, 4-poles, Cat. 5	09 45 545 1120		
Signal: 10-poles, 60 V / 3 A*	09 45 545 9010		

\* Order D-Sub crimp male contacts separately (see page 02.16)



Han® PushPull, type acc. to IEC 61 076-3-117 variant 14  
Housing bulkhead mounting for device integration and RJ45 jacks

## Features

- HARTING PushPull technology
- Compact design
- High packing density
- Device integration via RJ45 PCB connectors

## Technical characteristics

Locking	PushPull technology acc. to IEC 61 076-3-117
Degree of protection	IP 65 / IP 67
Mating face	RJ45 acc. to IEC 60 603-7
Termination type	Jack with solder termination
Mating cycles	min. 750
Temperature range	-40 °C ... +70 °C
Housing material	Plastic, black
Flammability acc. to UL 94	V 0

### Identification

### Part No.

### Drawing

### Dimensions in mm

#### Components device side

Housing bulkhead mounting plastic

09 35 002 0321

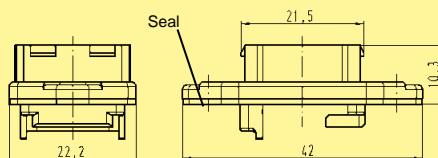

Dust protection cover IP 40 rubber (NBR)

09 35 002 5401

Protection cover IP 65 / IP 67

09 35 002 5402

RJ45 jack Solder variant, 90° angled

09 35 002 2101

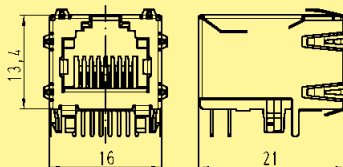

Solder variant, 180° straight

09 35 002 2102

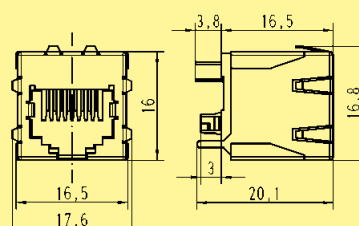

#### Panel cut out

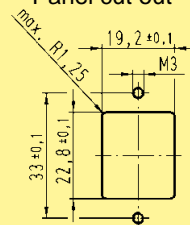

#### PCB layout

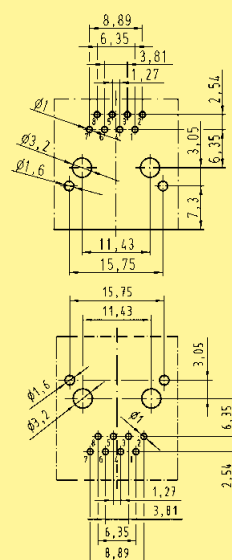

PushPull



Han® PushPull, type acc. to IEC 61 076-3-117 variant 14  
RJ45 panel feed through

PushPull

## Features

- HARTING PushPull technology
- Compact design
- High packing density
- Device integration via RJ45 PCB connectors

## Technical characteristics

Locking	PushPull technology acc. to IEC 61 076-3-117
Degree of protection	IP 65 / IP 67
Mating face	RJ45 acc. to IEC 60 603-7
Transmission performance	acc. to ISO/IEC 11801:2002, EN 50 173-1, category 5 / class D up to 100 MHz resp. category 6 / class E <sub>A</sub> up to 500 MHz
Transmission rate	10 / 100 Mbit/s and 1 / 10 Gbit/s
Number of contacts	8
Shielding	Fully shielded, 360° shielding contact (Cat. 6)
Mating cycles	min. 750
Temperature range	-40 °C ... +70 °C
Housing material	Plastic, black
Flammability acc. to UL 94	V 0

Identification	Part No.	Drawing	Dimensions in mm
----------------	----------	---------	------------------

**Han® PushPull RJ45**  
Panel feed through Cat. 5 including housing and printed board with 2 x RJ45 jack horizontally mounted

09 35 221 0331

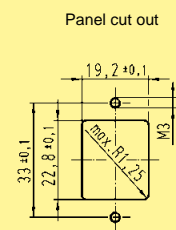
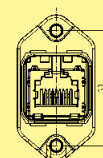
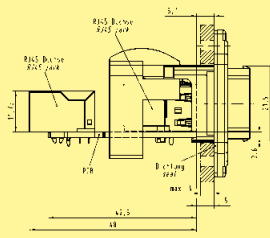

Panel feed through Cat. 5 including housing and printed board with RJ45 jack and SEK board

09 35 222 0331

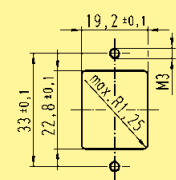
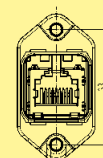
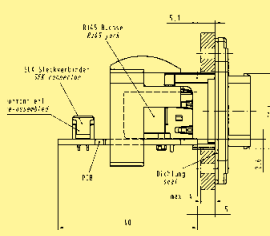

Panel feed through Cat. 5 including housing and printed board with RJ45 jack and RJ45 jack vertically mounted in the IP20 range

09 35 223 0331

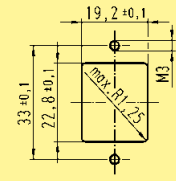
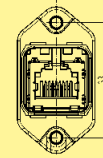
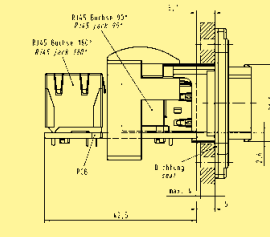

Identification	Part No.	Drawing	Dimensions in mm
<p>Panel feed through Cat. 5 including housing and printed board with RJ45 jack and 47° jack vertically mounted in the IP 20 range</p>	09 35 224 0331		<p>Panel cut out</p>
<p>Panel feed through Cat. 5 including housing and printed board with RJ45 jack and solder termination in the IP 20 range</p>	09 35 226 0331		<p>Panel cut out</p>
<p>Panel feed through Cat. 6 including housing and HARTING RJ Industrial® 10G RJ45 bulkhead</p>	09 35 225 0331		<p>Panel cut out</p>
<p>Panel feed through to mount HIFF inserts, e.g. Ha-VIS preLink® RJ45-module Order inserts separately</p>	09 35 012 0331		<p>Panel cut out</p>
<p>Ha-VIS preLink® set RJ45 jack AWG 22/23</p> <p>consists of:</p> <ul style="list-style-type: none"> <li>• 1x Ha-VIS preLink® module RJ45 jack</li> <li>• 1x Ha-VIS preLink® terminal module</li> <li>• 1x cable tie</li> </ul>	20 82 001 0001		
<p>HARTING RJ Industrial® cable jack</p> <p>AWG 22-24, 8-poles, Cat. 6</p> <p>AWG 24-28, 8-poles, Cat. 6</p> <p>AWG 22-24, 4-poles, Cat. 5</p>	<p>09 45 545 1562</p> <p>09 45 545 1561</p> <p>09 45 545 1120</p>	<p>see page 01.10</p>	



Han® PushPull, type acc. to IEC 61 076-3-117 variant 14  
RJ45 connector

PushPull

## Features

- HARTING PushPull technology
- Field-assembly connector with IDC contacts
- Fully shielded

## Technical characteristics

Locking	PushPull technology acc. to IEC 61 076-3-117
Degree of protection	IP 65 / IP 67
Mating face	RJ45 acc. to IEC 60 603-7
Shielding	Fully shielded, 360° shielding contact
Number of contacts	4 respectively 8
Transmission performance	acc. to ISO/IEC 11 801:2002, EN 50 173-1, category 5 / class D up to 100 MHz, category 6 / class E <sub>A</sub> up to 500 MHz
Transmission rate	10/100 Mbit/s and 1/10 Gbit/s
Termination for Cat. 5	with IDC contacts, no tools needed / field-assembly
for Cat. 6	Conductor cross section AWG 24/7 - 22/7 (stranded) AWG 23/1 - 22/1 (solid)
	Cable diameter 1.6 mm
for Cat. 6	Conductor cross section AWG 22/7 - 27/7 (stranded) AWG 22/1 - 27/1 (solid)
	Cable diameter 1.6 mm
Mating cycles	min. 750
Temperature range	-40 °C ... +70 °C
Housing material	Plastic, black, UL 94 V-0

## Identification

## Part No.

## Drawing

## Dimensions in mm

### Connector set, plastic

incl. housing and male insert

Han® RJ Industrial  
Category 5, 4-poles, IDC contacts

6.5 - 9.5 mm clamp range

5 - 8 mm clamp range

09 35 221 0421

09 35 222 0421

Han® RJ Industrial PN  
Category 5, 4-poles, IDC contacts

6.5 - 9.5 mm clamp range

PROFINET-Identification:  
PROFINET O-Plug RJ45

09 35 226 0421

Han® RJ Industrial 10G  
Category 6, 8-poles, IDC contacts

6.5 - 9.5 mm clamp range

09 35 225 0421

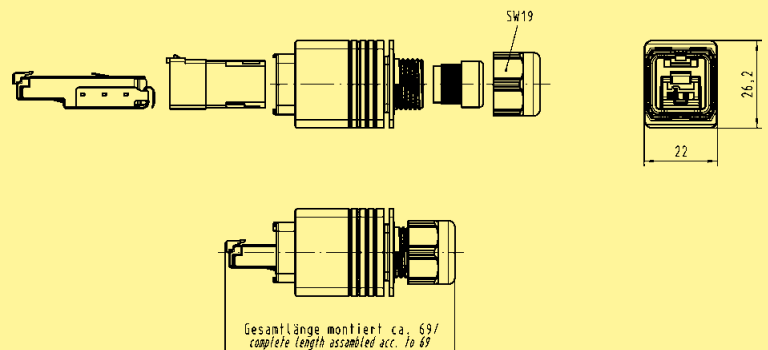



Han® PushPull, type acc. to IEC 61 076-3-117 variant 14 RJ45 connector

## Features

- HARTING PushPull technology
- Field-assembly connector with piercing contacts
- Fully shielded

## Technical characteristics

Locking	PushPull technology acc. to IEC 61 076-3-117
Degree of protection	IP 65 / IP 67
Mating face	RJ45 acc. to IEC 60 603-7
Shielding	Fully shielded, 360° shielding contact
Number of contacts	8
Transmission performance	acc. to ISO/IEC 11 801:2002, EN 50 173-1, category 6 / class E up to 250 MHz
Transmission rate	10/100/1000 Mbit/s
Termination	with piercing contacts
Conductor cross section	AWG 24/7 - 27/7 (stranded)
Cable diameter	1.05 mm
Mating cycles	min. 750
Temperature range	-40 °C ... +70 °C
Housing material	Plastic, black, UL 94 V-0

### Identification

### Part No.

### Drawing

### Dimensions in mm

#### Connector set, plastic

incl. housing and male insert  
5 - 8 mm clamp range

Han® RJ Industrial  
Category 6, 8-poles,  
piercing contacts

Wire manager, white

09 35 223 0421

Wire manager, blue

09 35 224 0421

New Cat. 6<sub>A</sub> version  
(available Q3/2012)

09 35 227 0421

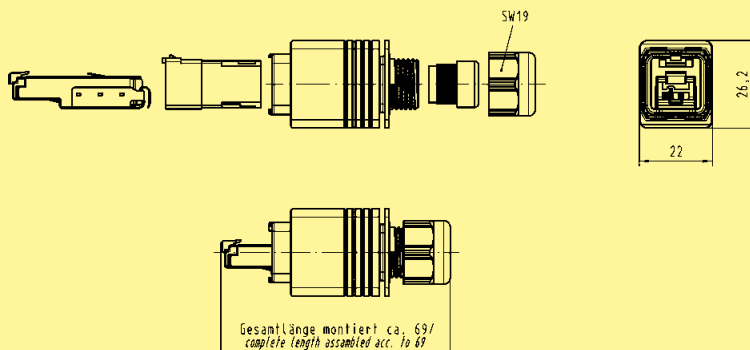





Han® PushPull, type acc. to IEC 61 076-3-117 variant 14  
Housing bulkhead mounting for device integration and RJ45 jacks

## Features

- HARTING PushPull technology
- Compact design
- High packing density
- Device integration via RJ45 PCB connectors

## Technical characteristics

Locking	PushPull technology acc. to IEC 61 076-3-117
Degree of protection	IP 65 / IP 67
Mating face	RJ45 acc. to IEC 60 603-7
Termination type	Jack with solder termination
Mating cycles	min. 750
Temperature range	-40 °C ... +70 °C
Housing material	Zinc die-cast, nickel plated

Identification	Part No.	Drawing	Dimensions in mm
----------------	----------	---------	------------------

### Components device side

Housing bulkhead mounting metal	09 35 002 0301		
---------------------------------	----------------	--	--

Dust protection cover IP 40 rubber (NBR)	09 35 002 5401		
--	----------------	--	--

Protection cover IP 65 / IP 67	09 35 002 5402		
--------------------------------	----------------	--	--

RJ45 jack Solder variant, 90° angled	09 35 002 2101		
---	----------------	--	--

Solder variant, 180° straight	09 35 002 2102		
-------------------------------	----------------	--	--

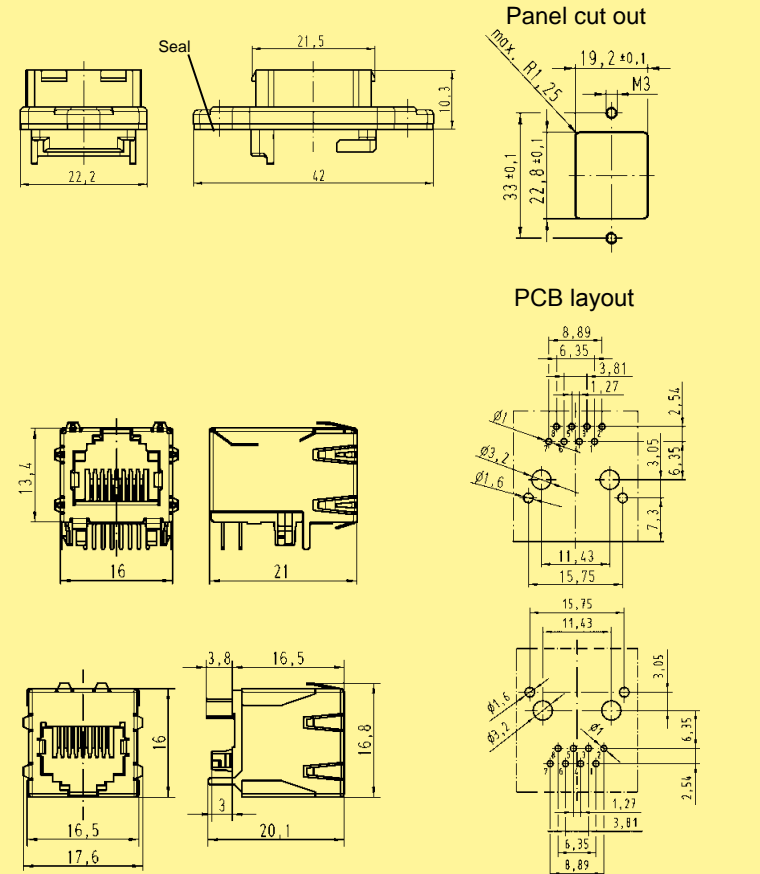



Han® PushPull, type acc. to IEC 61 076-3-117 variant 14  
RJ45 panel feed through

## Features

- HARTING PushPull technology
- Compact design
- High packing density
- Device integration via RJ45 PCB connectors

## Technical characteristics

Locking	PushPull technology acc. to IEC 61 076-3-117
Degree of protection	IP 65 / IP 67
Mating face	RJ45 acc. to IEC 60 603-7
Transmission performance	acc. to ISO/IEC 11801:2002, EN 50 173-1, category 5 / class D up to 100 MHz
Transmission rate	10 / 100 Mbit/s
Number of contacts	8
Shielding	Fully shielded, 360° shielding contact (Cat. 6)
Termination type	Female with solder termination
Mating cycles	min. 750
Temperature range	-40 °C ... +70 °C
Housing material	Zinc die-cast, nickel plated

PushPull

### Identification

### Part No.

### Drawing

### Dimensions in mm

#### Han® PushPull RJ45

Panel feed through Cat. 5 including housing and printed board with 2 x RJ45 jack horizontally mounted

09 35 221 0311

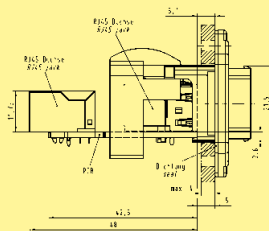

Panel cut out

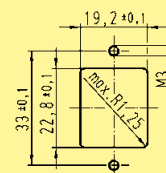

Panel feed through Cat. 5 including housing and printed board with RJ45 jack and SEK board

09 35 222 0311

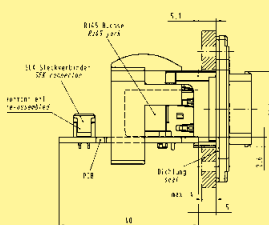

Panel cut out

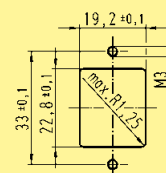

Panel feed through Cat. 5 including housing and printed board with RJ45 jack and RJ45 jack vertically mounted in the IP20 range

09 35 223 0311

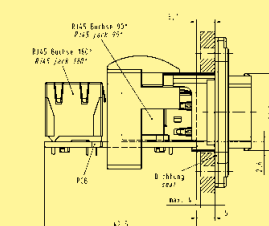

Panel cut out

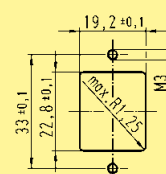





Han® PushPull, type acc. to IEC 61076-3-117 variant 14  
RJ45 10G panel feed through



## Features

- HARTING PushPull technology
- Compact and robust design
- 360° shielding
- RJ45 mating compatible
- Transmission category 6, performance class E<sub>A</sub>, suitable for 1/10 Gigabit Ethernet
- PROFINET conform

## Technical characteristics

Locking	PushPull technology acc. to IEC 61 076-3-117 variant 14 RJ45 acc. to IEC 60 603-7
Mating face	
Transmission performance	Category 6 / class E <sub>A</sub> acc. to ISO/IEC 11 801:2002, EN 50 173-1
Transmission rate	10/100 Mbit/s and 1/10 Gbit/s
Shielding	Fully shielded, 360° shielding contact
Mounting	Screwable to cover plates
Degree of protection	IP 65 / IP 67
Mating cycles	min. 750
Temperature range	-40 °C ... +70 °C
Housing material	Zinc die-cast, nickel-plated

PushPull

### Identification

### Part No.

### Drawing

### Dimensions in mm

#### Han® PushPull RJ45 10G

Panel feed through, Cat. 6 including bulkhead housing for rectangular panel cut out, flat seal and HARTING RJ Industrial® 10G RJ45 bulkhead, isolated bulkhead fixture

09 35 225 0311

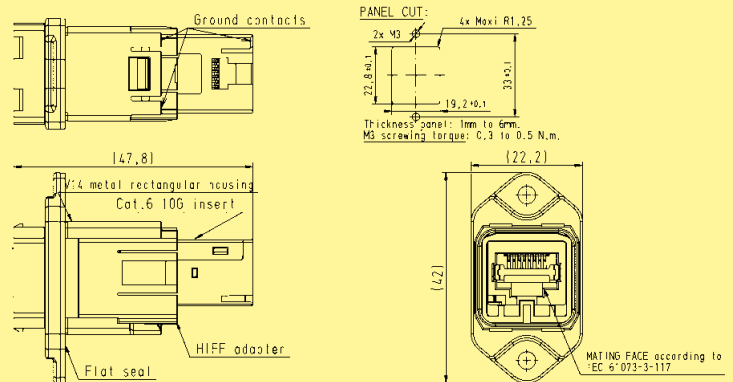

Panel feed through, Cat. 6 including bulkhead housing for circular panel cut out, flat seal and HARTING RJ Industrial® 10G RJ45 bulkhead, isolated bulkhead fixture

09 35 225 0312

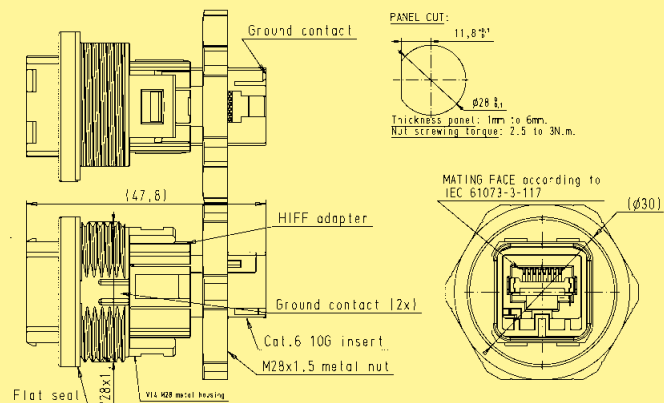

Identification

Part No.

Drawing

Dimensions in mm

## Han® PushPull RJ45 10G

Panel feed-through to mount HIFF inserts, e.g. Ha-VIS preLink® RJ45-module, RJ Industrial cable jack  
Order inserts separately

Bulkhead housing for rectangular panel cut out, incl. plastic adapter

09 35 012 0311

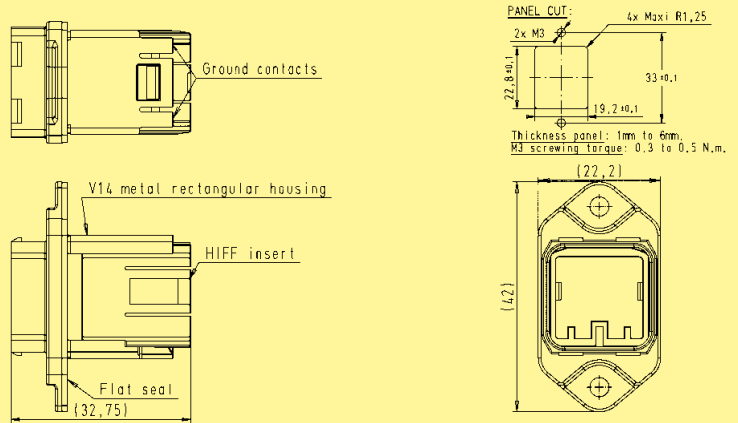

Bulkhead housing for circular panel cut out, incl. plastic adapter and fixing nut

09 35 012 0312

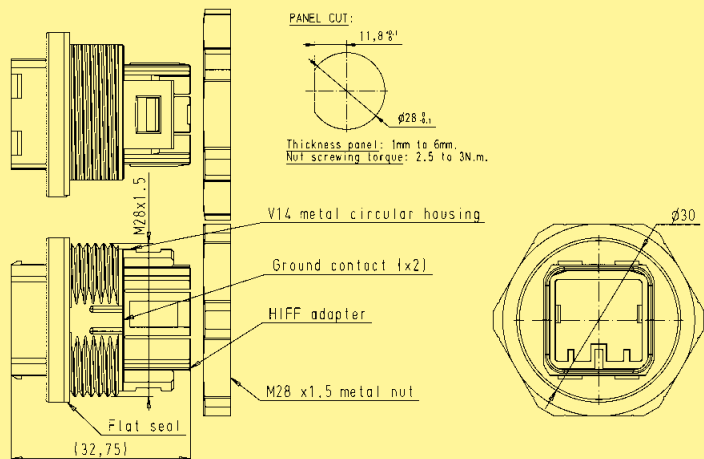

## Ha-VIS preLink® set RJ45 jack AWG 22/23

consists of:

- 1x Ha-VIS preLink® module RJ45 jack
- 1x Ha-VIS preLink® terminal module
- 1x cable tie

20 82 001 0001

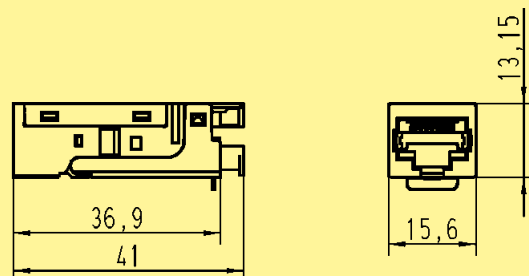

## HARTING RJ Industrial® cable jack

- AWG 22-24, 8-poles, Cat. 6
- AWG 24-28, 8-poles, Cat. 6
- AWG 22-24, 4-poles, Cat. 5

09 45 545 1562  
09 45 545 1561  
09 45 545 1120



## Han® PushPull RJ45 Genderchanger Metal Cat. 6 / Class E

### Features

- High degree of protection IP 65 / IP 67
- Robust metal housing
- Standard PROFINET component of the German automotive production
- Allows usage of different cable types (Type B, C) e.g. in robots application
- Extension of cords according to PROFINET guideline
- Can be count as one connection acc. to IEC 11801 Chapter 10.2.4

### Technical characteristics

Transmission performance	Cat. 6 / Class E up to 250 MHz
Connector	Han® PushPull RJ45 (PROFINET conform)
Locking	PushPull technology acc. to IEC 61076-3-117 variant 14
Mating face	RJ45 acc. to IEC 60603-7
Mating cycles	min. 750
Housing material	Aluminium anodized
Dimensions	83.2 x 62 x 25.2 mm (unmated)
Degree of protection acc. to DIN 60529	IP 65 / IP 67 (mated)
Mounting	Wall mountable with 4 screws (type M5)
Temperature range	-20 °C ... +70 °C
Maximum permissible humidity	30 % ... 95 % (no condensation)

PushPull

Identification

Part No.

Drawing

Dimensions in mm

Han® PushPull RJ45  
Genderchanger metal  
including housing and printed board  
with 2 x RJ45 jack

09 35 221 0501

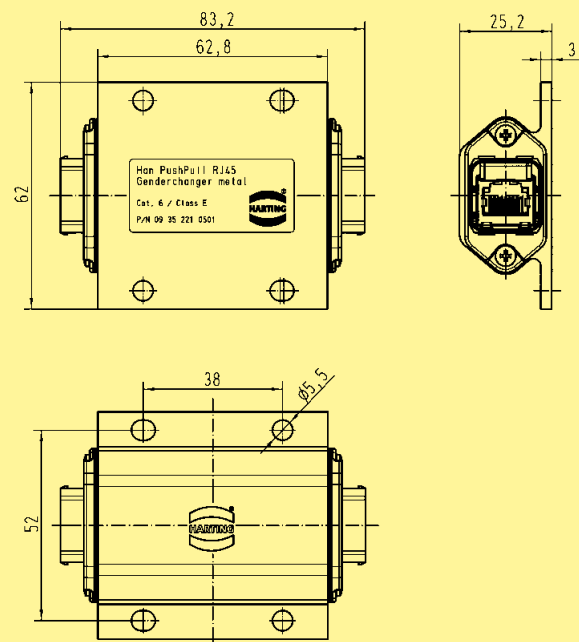



Han® PushPull, type acc. to IEC 61 076-3-117 variant 14 RJ45 connector

PushPull

## Features

- HARTING PushPull technology
- Field-assembly connector with IDC contacts
- Fully shielded

## Technical characteristics

Locking	PushPull technology acc. to IEC 61 076-3-117
Degree of protection	IP 65 / IP 67
Mating face	RJ45 acc. to IEC 60 603-7
Shielding	Fully shielded, 360° shielding contact
Number of contacts	4 respectively 8
Transmission performance	acc. to ISO/IEC 11 801:2002, EN 50 173-1, category 5 / class D up to 100 MHz category 6 / class E <sub>A</sub> up to 500 MHz
Transmission rate	10/100 Mbit/s and 1/10 Gbit/s
Termination	with IDC contacts, no tools needed / field-assembly
for Cat. 5	
Conductor cross section	AWG 24/7 - 22/7 (stranded) AWG 23/1 - 22/1 (solid)
Cable diameter	1.6 mm
for Cat. 6	
Conductor cross section	AWG 22/7 - 27/7 (stranded) AWG 22/1 - 27/1 (solid)
Cable diameter	1.6 mm
Mating cycles	min. 750
Temperature range	-40 °C ... +70 °C
Housing material	Zinc die-cast, nickel-plated

Identification	Part No.	Drawing	Dimensions in mm
----------------	----------	---------	------------------

Connector set, metal  
incl. housing and male insert  
4 - 11 mm clamp range

Han® RJ Industrial  
Category 5, 4-poles, IDC contacts

09 35 221 0401

Han® RJ Industrial PN  
Category 5, 4-poles, IDC contacts  
PROFINET-Identification:  
PROFINET O-Plug RJ45

09 35 226 0401

Han® RJ Industrial 10G  
Category 6, 8-poles, IDC contacts

09 35 225 0401

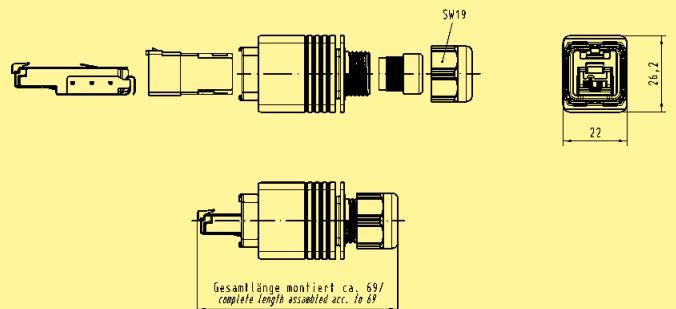

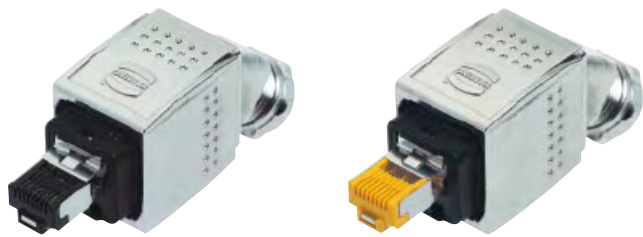

Han® PushPull, type acc. to IEC 61 076-3-117 variant 14  
RJ45 connector angled

## Features

- HARTING PushPull technology
- Angled cable exit 45° to the top / bottom for a space saving cabling
- Field-assembly connector with IDC contacts
- Fully shielded

## Technical characteristics

Locking	PushPull technology acc. to IEC 61 076-3-117
Degree of protection	IP 65 / IP 67
Mating face	RJ45 acc. to IEC 60 603-7
Shielding	Fully shielded, 360° shielding contact
Number of contacts	4 respectively 8
Transmission performance	acc. to ISO/IEC 11 801:2002, EN 50 173-1, category 5 / class D up to 100 MHz category 6 / class E <sub>A</sub> up to 500 MHz
Transmission rate	10/100 Mbit/s and 1/10 Gbit/s
Termination	with IDC contacts, no tools needed / field-assembly
for Cat. 5	
Conductor cross section	AWG 24/7 - 22/7 (stranded) AWG 23/1 - 22/1 (solid)
Cable diameter	1.6 mm
for Cat. 6	
Conductor cross section	AWG 22/7 - 27/7 (stranded) AWG 22/1 - 27/1 (solid)
Cable diameter	1.6 mm
Mating cycles	min. 750
Temperature range	-40 °C ... +70 °C
Housing material	Zinc die-cast, nickel-plated

Identification	Part No.	Drawing	Dimensions in mm
----------------	----------	---------	------------------

Connector set,  
metal

incl. housing  
and male insert

Han® RJ Industrial PN  
Category 5, 4-poles, IDC contacts,  
6.5 - 9.5 mm clamp range

Cable exit bottom side

09 35 226 0402

Cable exit top side

09 35 226 0403

Han® RJ Industrial 10G  
Category 6, 8-poles, IDC contacts,  
6.5 - 9.5 mm clamp range

Cable exit bottom side

09 35 225 0402

Cable exit top side

09 35 225 0403

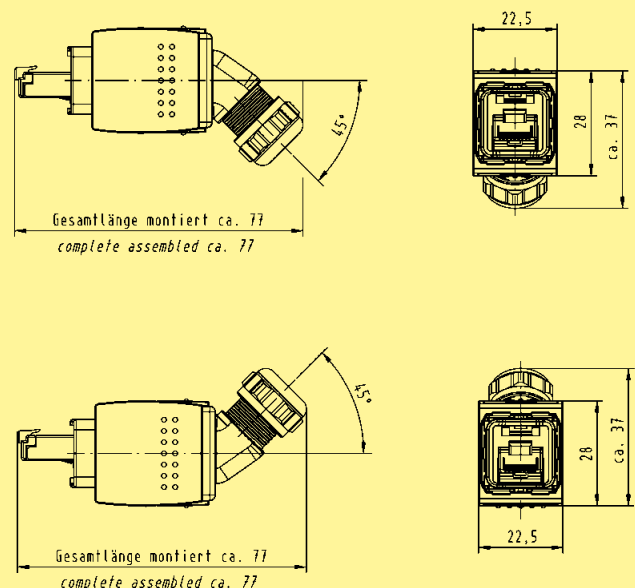

PushPull





Han® PushPull, type acc. to IEC 61 076-3-117 variant 14  
RJ45 connector

PushPull

## Features

- HARTING PushPull technology
- Compact design
- For space saving fitting conditions
- Connector with piercing contacts
- 360° shielding

## Technical characteristics

Locking	PushPull technology acc. to IEC 61 076-3-117
Degree of protection	IP 65 / IP 67
Mating face	RJ45 acc. to IEC 60 603-7
Shielding	Fully shielded, 360° shielding contact
Number of contacts	8
Transmission performance	acc. to ISO/IEC 11 801:2002, EN 50 173-1, category 6 / class E up to 250 MHz
Transmission rate	10/100/1000 Mbit/s
Termination	with piercing contacts
Conductor cross section	AWG 24/7 - 27/7 (stranded)
Cable diameter	1.05 mm
Mating cycles	min. 750
Temperature range	-40 °C ... +70 °C
Housing material	Zinc die-cast, nickel-plated

### Identification

### Part No.

### Drawing

### Dimensions in mm

#### Connector set, metal

incl. housing  
and male insert  
4 - 11 mm clamp range

Han® RJ Industrial  
Category 6, 8-poles,  
piercing contacts

Wire manager, white

09 35 223 0401

Wire manager, blue

09 35 224 0401

New Cat. 6<sub>A</sub> version  
(available Q3/2012)

09 35 227 0401

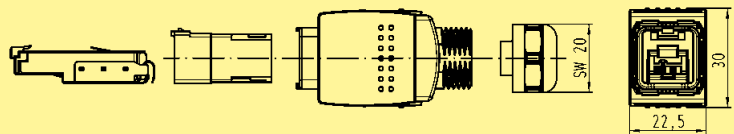

available  
Q2 / 2012



Han® PushPull, type acc. to IEC 61 076-3-117 variant 14  
cable to cable housing

## Features

- HARTING PushPull technology
- Ideal for prototyping
- Can be combined with panel feed-throughs for power, data and signal

## Technical characteristics

Locking	PushPull technology acc. to IEC 61 076-3-117 variant 14
Degree of protection	IP 65 / IP 67
Outer cable diameter	6.5 ... 9.5 mm / 9 ... 13 mm
Mating cycles	min. 750
Temperature range	-40 °C ... +70 °C
Housing material	Plastic, black
Flammability acc. to UL 94	V 0

Identification	Part No.	Drawing	Dimensions in mm
<b>Han® PushPull cable to cable housings, plastic</b> (Order housing bulkhead mounting and insert separately)		2X REMFORM $\phi 3 \times 8$ TORX screws 	
for outer cable diameter 6.5 ... 9.5 mm	09 35 002 0431		
for outer cable diameter 9 ... 13 mm	09 35 002 0433	2X REMFORM $\phi 3 \times 8$ TORX screws 	
<b>Suitable bulkhead housing, plastic</b> for RJ45	09 35 012 0331	<p>Panel cut out</p> <p>Thickness panel: 1mm to 6mm M3 screwing Torque: 0.3 to 0.5 N.m.</p>	
<b>Inserts for RJ45</b> RJ 45: 8-poles, Cat. 6 / class E <sub>A</sub> Ha-Vis preLink® set AWG 22/23 HARTING RJ Industrial® cable jack with IDC termination	20 82 001 0001		
AWG 22-24, 8-poles	09 45 545 1562		
AWG 24-28, 8-poles	09 45 545 1561		
AWG 22-24, 4-poles, Cat. 5	09 45 545 1120		

## Han® PushPull, type acc. to IEC 61 076-3-117 variant 14 Accessories

PushPull

Identification	Part No.	Drawing	Dimensions in mm
----------------	----------	---------	------------------

Han® PushPull dust protection cover IP 40 rubber (NBR)

for device side

09 35 002 5401

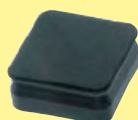

Han® PushPull protection cover IP 65 / IP 67

for device side with fixing cord

1 piece

09 35 002 5402

100 pieces

09 35 002 5402 XL



without fixing cord

100 pieces

09 35 002 5403 XL

Han® PushPull dust protection cover IP 40

for cable side

09 35 002 5412



Han® PushPull protection cover IP 65 / IP 67

for cable side

09 35 002 5411





Han® PushPull, type acc. to IEC 61 076-3-117 variant 14  
 Housing bulkhead mounting for device integration  
 Optical connector based on SCRJ

## Features

- HARTING PushPull technology
- Compact design
- High packing density
- Device integration via transceiver
- Han® PushPull SCRJ for POF is according the requirements of AIDA (German Domestic Automobile Manufacturers)

## Technical characteristics

Locking	PushPull technology
Degree of protection	IP 65 / IP 67
Mating face	SCRJ acc. to IEC 61 754-24
Fiber Typen	POF <sup>1)</sup> 1 mm HCS <sup>2)</sup> 200 µm / 230 µm MM 62.5 µm / 125 µm MM 50 µm / 125 µm SM 10 µm / 125 µm
Mating cycles	min. 750
Temperature range	-40 °C ... +70 °C
Housing material	Plastic, black
Flammability acc. to UL 94	V 0

### Identification

### Part No.

### Drawing

### Dimensions in mm

#### Components device side

Housing bulkhead mounting  
 Optical transceiver  
 not included

plastic

09 35 002 0323

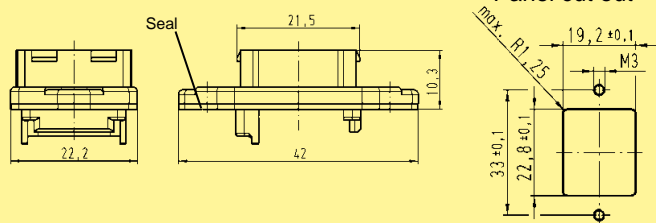

Dust protection cover IP 40  
 rubber (NBR)

09 35 002 5401

Protection cover IP 65 / IP 67

09 35 002 5402

Reference for transceiver  
 as well as mounting instruction  
 on request

1) POF = Polymer-Optical Fibre  
 2) HCS® = Hard Clad Silica (registered trademark of SpecTran Corporation)



Han® PushPull, type acc. to IEC 61 076-3-117 variant 14  
 RJ45 panel feed through  
 for optical connector based on SCRJ



PushPull

## Features

- HARTING PushPull technology
- Compact design
- High packing density
- Han® PushPull SCRJ for POF is according the requirements of AIDA (German Domestic Automobile Manufacturers)

## Technical characteristics

Locking	PushPull technology
Degree of protection	IP 65 / IP 67
Mating face	SCRJ acc. to IEC 61 754-24
Fiber Typen	POF <sup>1)</sup> 1 mm HCS <sup>2)</sup> 200 µm / 230 µm MM 62.5 µm / 125 µm MM 50 µm / 125 µm SM 10 µm / 125 µm
Mating cycles	min. 750
Temperature range	-40 °C ... +70 °C
Housing material	Plastic, black
Flammability acc. to UL 94	V 0

### Identification

### Part No.

### Drawing

### Dimensions in mm

#### Han® PushPull SCRJ

Panel feed through  
 SC contacts order separately

09 35 242 0333

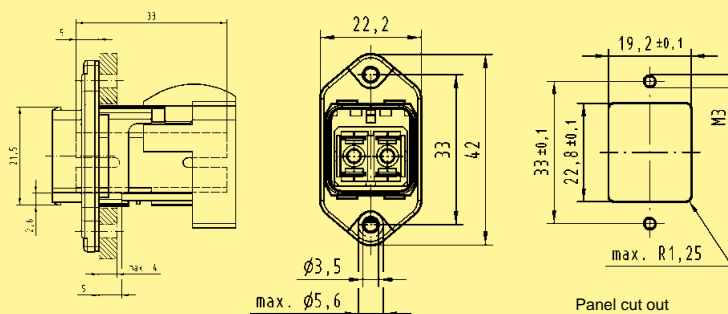

#### SCRJ IP 20 POF connector

09 35 002 4002

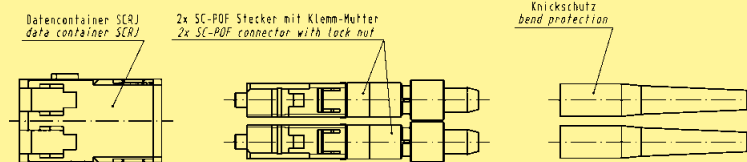

### Contacts

SC POF contact, 1 mm	20 10 001 5217
SC 125 GI contact	20 10 125 5211
SC 230 HCS contact	20 10 230 5211

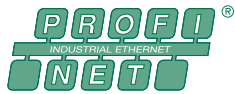

Han® PushPull, type acc. to IEC 61 076-3-117 variant 14  
SCRJ connector



## Features

- HARTING PushPull technology
- Compact design
- High packing density
- Han® PushPull SCRJ for POF is according the requirements of AIDA (German Domestic Automobile Manufacturers)
- Field installable

## Technical characteristics

Locking	PushPull technology
Degree of protection	IP 65 / IP 67
Mating face	SCRJ acc. to IEC 61 754-24
Fiber Typen	POF <sup>1)</sup> 1 mm HCS <sup>2)</sup> 200 µm / 230 µm MM 62.5 µm / 125 µm MM 50 µm / 125 µm SM 10 µm / 125 µm
Mating cycles	min. 750
Temperature range	-40 °C ... +70 °C
Housing material	Plastic, black
Flammability acc. to UL 94	V 0
Cable diameter	6.5 - 9.5 mm

Identification	Part No.	Drawing	Dimensions in mm
----------------	----------	---------	------------------

**Connector set, plastic**  
incl. housing and SCRJ insert,  
POF contacts

09 35 241 0421

PROFINET-Identification:  
PROFINET O-Plug SCRJ

incl. housing and SCRJ insert  
SC contacts order separately

09 35 241 0422

**SCRJ IP 20**  
**POF connector**

09 35 002 4002

Dust protection cover IP 40

09 35 002 5412

Protection cover IP 65 / IP 67

09 35 002 5411

### Contacts

SC POF contact, 1 mm  
SC 125 GI contact  
SC 230 HCS contact

20 10 001 5217  
20 10 125 5211  
20 10 230 5211

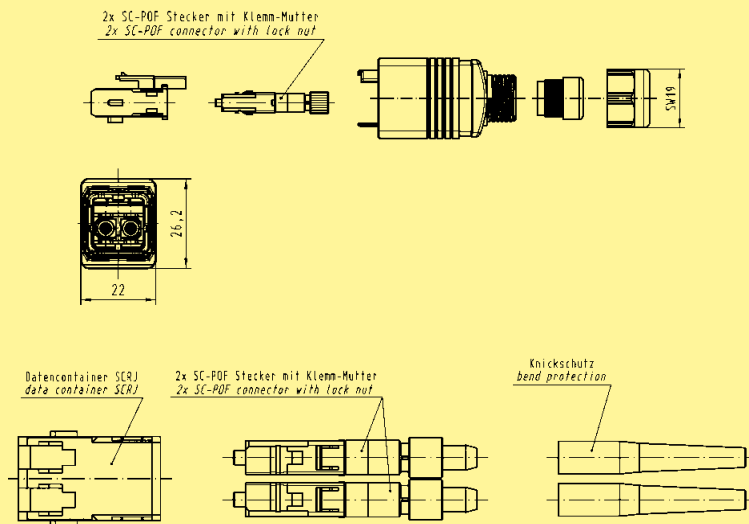



Han® PushPull, type acc. to IEC 61 076-3-117 variant 14  
 Housing bulkhead mounting for device integration  
 Optical connector based on SCRJ

PushPull

## Features

- HARTING PushPull technology
- Compact design
- High packing density
- Device integration via transceiver
- Han® PushPull SCRJ for POF is according the requirements of AIDA (German Domestic Automobile Manufacturers)

## Technical characteristics

Locking	PushPull technology
Degree of protection	IP 65 / IP 67
Mating face	SCRJ acc. to IEC 61 754-24
Fiber Typen	POF <sup>1)</sup> 1 mm HCS <sup>2)</sup> 200 µm / 230 µm MM 62.5 µm / 125 µm MM 50 µm / 125 µm SM 10 µm / 125 µm
Mating cycles	min. 750
Temperature range	-40 °C ... +70 °C
Housing material	Zinc die-cast, nickel plated

### Identification

### Part No.

### Drawing

### Dimensions in mm

#### Components device side

Housing bulkhead mounting  
 Optical transceiver  
 not included

metal

09 35 002 0303

Dust protection cover IP 40  
 rubber (NBR)

09 35 002 5401

Protection cover IP 65 / IP 67

09 35 002 5402

Reference for transceiver  
 as well as mounting instruction  
 on request

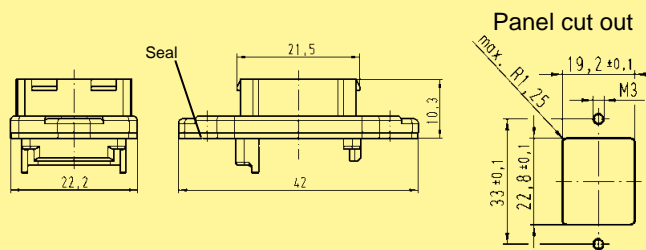

1) POF = Polymer-Optical Fibre  
 2) HCS® = Hard Clad Silica (registered trademark of SpecTran Corporation)



Han® PushPull, type acc. to IEC 61 076-3-117 variant 14  
 RJ45 panel feed through  
 for optical connector based on SCRJ

## Features

- HARTING PushPull technology
- Compact design
- High packing density
- Han® PushPull SCRJ for POF is according the requirements of AIDA (German Domestic Automobile Manufacturers)

## Technical characteristics

Locking	PushPull technology
Degree of protection	IP 65 / IP 67
Mating face	SCRJ acc. to IEC 61 754-24
Fiber Typen	POF <sup>1)</sup> 1 mm HCS <sup>2)</sup> 200 µm / 230 µm MM 62.5 µm / 125 µm MM 50 µm / 125 µm SM 10 µm / 125 µm
Mating cycles	min. 750
Temperature range	-40 °C ... +70 °C
Housing material	Zinc die-cast, nickel plated

### Identification

### Part No.

### Drawing

### Dimensions in mm

#### Han® PushPull SCRJ

Panel feed through

09 35 242 0313

SC contacts order separately

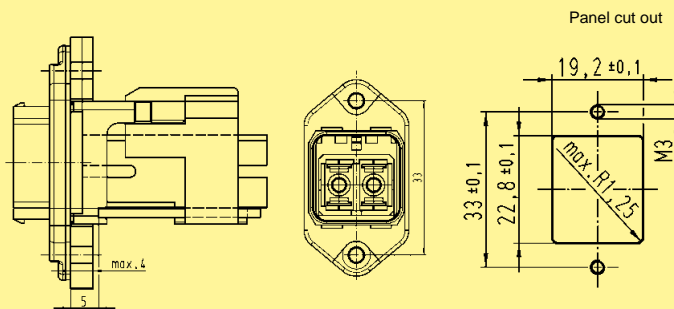

#### SCRJ IP 20

POF connector

09 35 002 4002

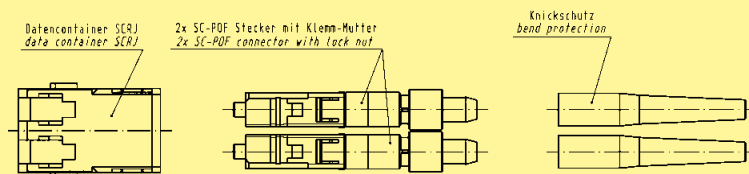

#### Contacts

- SC POF contact, 1 mm
- SC 125 GI contact
- SC 230 HCS contact

20 10 001 5217  
 20 10 125 5211  
 20 10 230 5211





Han® PushPull, type acc. to IEC 61 076-3-117 variant 14  
SCRJ connector

PushPull

## Features

- HARTING PushPull technology
- Compact design
- High packing density
- Han® PushPull SCRJ for POF is according the requirements of AIDA (German Domestic Automobile Manufacturers)
- Field installable

## Technical characteristics

Locking	PushPull technology
Degree of protection	IP 65 / IP 67
Mating face	SCRJ acc. to IEC 61 754-24
Fiber Typen	POF <sup>1)</sup> 1 mm HCS <sup>2)</sup> 200 µm / 230 µm MM 62.5 µm / 125 µm MM 50 µm / 125 µm SM 10 µm / 125 µm
Mating cycles	min. 750
Temperature range	-40 °C ... +70 °C
Housing material	Zinc die-cast, nickel plated
Flammability acc. to UL 94	V 0
Cable diameter	6.5 - 9.5 mm

Identification	Part No.	Drawing	Dimensions in mm
----------------	----------	---------	------------------

### Connector set, metal

incl. housing and SCRJ insert,  
POF contacts

09 35 241 0401

PROFINET-Identification:  
PROFINET O-Plug SCRJ

incl. housing and SCRJ insert  
SC contacts order separately

09 35 241 0402

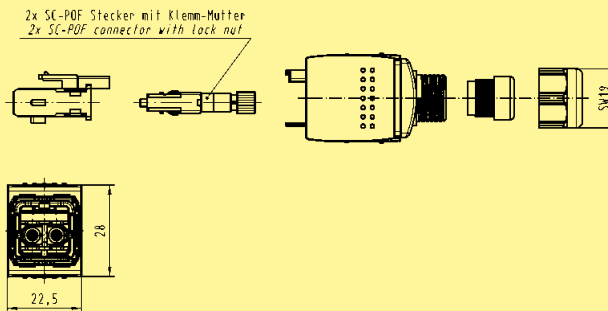

### SCRJ IP 20 POF connector

09 35 002 4002

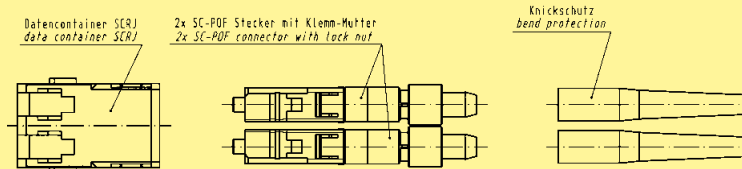

### Dust protection cover IP 40

09 35 002 5412

### Protection cover IP 65 / IP 67

09 35 002 5411

### Contacts

- SC POF contact, 1 mm
- SC 125 GI contact
- SC 230 HCS contact

20 10 001 5217  
20 10 125 5211  
20 10 230 5211



Han® PushPull SCRJ POF  
Assembly tools for polymer-optical fibres

## Features

- Cable insulation (PUR / PVC) is stripped without damage
- The 'stripping' and 'precision cutting' operations are completed within the one tool
- Specialized cutting method with an automatically advancing round blade for an accurate cutting result requiring no final polishing
- Optical display indicating remaining operations
- Simultaneous handling of twin fibers (duplex mode)

## Technical characteristics

Connector type	SCRJ connector acc. to IEC 61 754-24
Locking	PushPull technology acc. to IEC 61 076-3-117 variant 14 (AIDA compliant)
Insertion loss	typically 1.5 to 2.0 dB
Termination SC contacts	Fast termination technique, reusable
Fibre dimensions	POF 980 / 1000 µm
Fibre outer diameter	2.2 mm
Cable outer diameter	7 to 8.5 mm
No. of cutting operations	Maximum 1260

### Identification

### Part No.

### Drawing

### Dimensions in mm

#### Assembly tool set for POF cutting, without final polishing

The set contains  
 - one stripping and cutting tool for 1260 operations  
 - one sheath stripping tool  
 - one Kevlar shear  
 - one positioner for SCRJ contacts  
 Supplied in a robust plastic case

09 35 000 9913

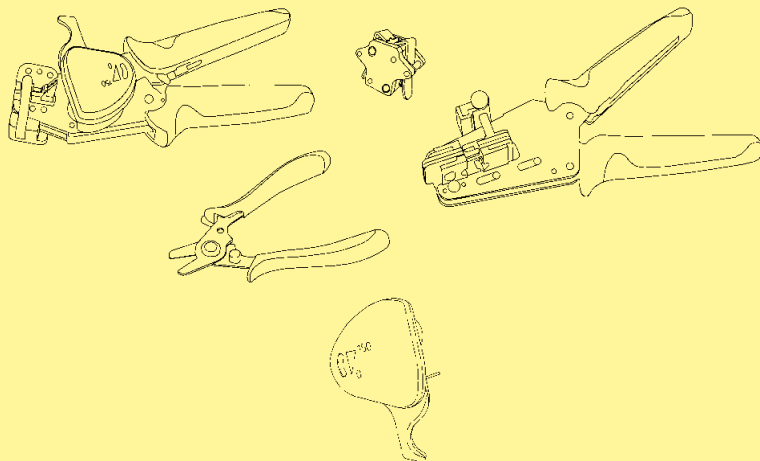

Replacement cutting tool for 1260 operations

09 35 000 9914

#### Assembly tool set for POF cutting, with final polishing

Without an optical meter  
 With an optical meter

20 99 000 3016  
 20 99 000 3013

#### Polishing wheel (grinding wheel) for POF cables 2.2

20 99 000 1099

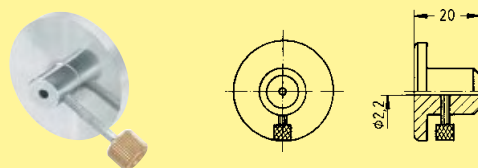

#### Sand paper for POF, grain size 1000

20 80 001 9911

PushPull

available  
Q3 / 2012



Han® PushPull, type acc. to IEC 61 076-3-117 variant 14  
10-poles 100 V / 5 A

PushPull

## Features

- HARTING PushPull technology
- For the transmission of analog, low voltage and bus signals
- Fully shielded
- 10 contacts
- Touch-proof
- Easy and fast cable installation

## Technical characteristics

Locking	PushPull technology acc. to IEC 61 076-3-117 variant 14
Degree of protection	IP 65 / IP 67
Mating face	acc. to IEC/PAS 61076-3-11x
Number of contacts	10
Electrical data acc. to DIN EN 61984	5 A 100 V 1.5 kV 3
Contact resistance	10 mΩ
Termination	Crimp
Conductor cross section	AWG 24 ... 18; 0.25 ... 0.82 mm <sup>2</sup>
Conductor diameter	max. 2.1 mm
Outer cable diameter	6.5 ... 9.5 mm / 4 ... 11 mm
Shielding	Fully shielded, 360° shielding contact
Mating cycles	min. 500
Temperature range	-40 °C ... +70 °C
Housing material	Plastic, black Zinc die-cast, nickel-plated
Flammability acc. to UL 94	V 0

Identification	Part No.	Drawing	Dimensions in mm
----------------	----------	---------	------------------

### Han® PushPull Signal Insert

for panel feed-through HIFF,  
10-poles  
incl. male insert

Order D-Sub crimp male  
contacts separately

09 45 545 9010

### D-Sub crimp contacts

(Device side)  
for AWG 24-20; 0.25-0.56 mm<sup>2</sup>  
for AWG 22-18; 0.33-0.82 mm<sup>2</sup>

09 67 000 8178<sup>1)</sup>  
09 67 000 3576<sup>2)</sup>

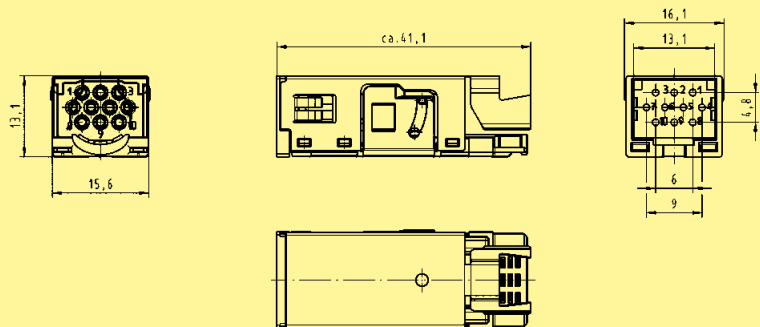

<sup>1)</sup> To be used with crimp tool 09 99 000 0175  
<sup>2)</sup> To be used with crimp tool 09 99 000 0501. Suitable locator: 61 03 600 0531

Identification	Part No.	Drawing	Dimensions in mm
<p><b>Han® PushPull panel feed-through HIFF</b> to hold the 10-poles insert</p>			
Metal rectangular	09 35 012 0311		
Metal circular	09 35 012 0312		
Plastic rectangular	09 35 012 0331		
<p><b>D-Sub crimp contacts</b> (Connector side) for AWG 24-20; 0.25-0.56 mm<sup>2</sup> for AWG 22-18; 0.33-0.82 mm<sup>2</sup></p>	<p>09 67 000 8278<sup>1)</sup> 09 67 000 3476<sup>2)</sup></p>		
<p>(Device side) for AWG 24-20; 0.25-0.56 mm<sup>2</sup> for AWG 22-18; 0.33-0.82 mm<sup>2</sup></p>	<p>09 67 000 8178<sup>1)</sup> 09 67 000 3576<sup>2)</sup></p>		

<sup>1)</sup> To be used with crimp tool 09 99 000 0175  
<sup>2)</sup> To be used with crimp tool 09 99 000 0501. Suitable locator: 61 03 600 0531

available  
Q3 / 2012



Han® PushPull, type acc. to IEC 61 076-3-117 variant 14  
10-poles 100 V / 5 A

## Features

- HARTING PushPull technology
- For the transmission of analog, low voltage and bus signals
- Fully shielded
- 10 contacts
- Touch-proof
- Easy and fast cable installation

## Technical characteristics

Locking	PushPull technology acc. to IEC 61 076-3-117 variant 14
Degree of protection	IP 65 / IP 67
Mating face	acc. to IEC/PAS 61076-3-11x
Number of contacts	10
Electrical data acc. to DIN EN 61984	5 A 100 V 1.5 kV 3
Contact resistance	10 mΩ
Termination	Crimp
Conductor cross section	AWG 24 ... 18; 0.25 ... 0.82 mm <sup>2</sup>
Conductor diameter	max. 2.1 mm
Outer cable diameter	6.5 ... 9.5 mm / 4 ... 11 mm
Shielding	Fully shielded, 360° shielding contact
Mating cycles	min. 500
Temperature range	-40 °C ... +70 °C
Housing material	Plastic, black Zinc die-cast, nickel-plated
Flammability acc. to UL 94	V 0

Identification	Part No.	Drawing	Dimensions in mm
----------------	----------	---------	------------------

### Han® PushPull Signal

Connector set 10-poles  
incl. metal housing  
and female insert  
4 ... 11 mm

09 35 261 0401

Connector set 10-poles  
incl. plastic housing  
and female insert  
6.5 ... 9.5 mm

09 35 261 0421

Order D-Sub crimp female  
contacts separately

### D-Sub crimp contacts

(Connector side)  
for AWG 24-20; 0.25-0.56 mm<sup>2</sup>  
for AWG 22-18; 0.33-0.82 mm<sup>2</sup>

09 67 000 8278<sup>1)</sup>  
09 67 000 3476<sup>2)</sup>

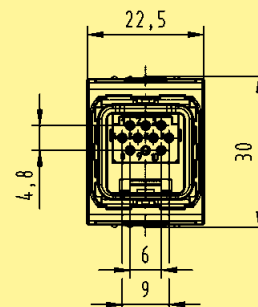
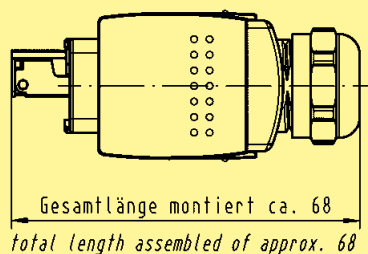

<sup>1)</sup> To be used with crimp tool 09 99 000 0175

<sup>2)</sup> To be used with crimp tool 09 99 000 0501. Suitable locator: 61 03 600 0531



Han® PushPull, type acc. to IEC 61 076-3-118  
Housing bulkhead mounting and power females for device integration

## Features

- HARTING PushPull technology
- Compact, space-saving design
- Touch-proof
- Device side: male
  - Solder variant, angled and straight
- 4 times coding without contact loss

## Technical characteristics

Locking	PushPull technology acc. to IEC 61 076-3-118
Degree of protection	IP 65 / IP 67
Number of contacts	4 + PE
Electrical data acc. to DIN EN 61 984	16 A 230/400 V 4 kV 3
Termination	Male insert with solder termination
Mating cycles	min. 500
Temperature range	-40 °C ... +70 °C
Housing material	Plastic, black
Flammability acc. to UL 94	V 0

### Identification

### Part No.

### Drawing

### Dimensions in mm

#### Components device side

Housing bulkhead mounting plastic	09 35 002 0323
Dust protection cover IP 40, rubber (NBR)	09 35 002 5401
Protection cover IP 65 / IP 67	09 35 002 5402
Coding pins	09 35 000 6190
Male insert with solder termination angled	09 35 002 3003
Male insert with solder termination straight	09 35 002 3004

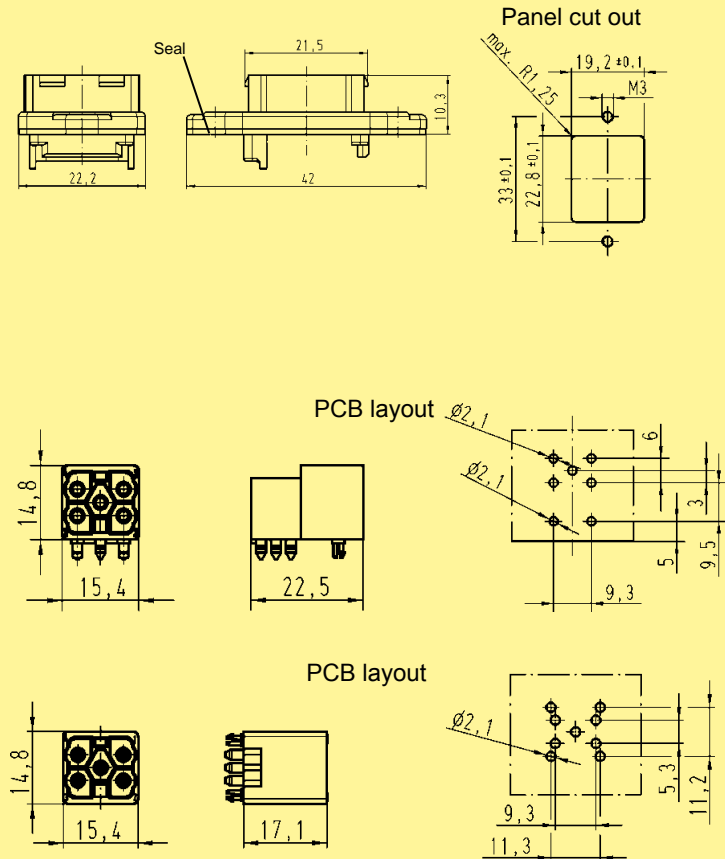



available  
Q2 / 2012



Han® PushPull, type acc. to IEC 61 076-3-118  
Panel feed-through, 5-poles, 230/400 V, 16 A

### Features

- HARTING PushPull technology
- Compact, space-saving design
- Touch-proof
- Panel feed-through: male
  - crimp termination
  - Han-Quick Lock® termination technology
- 4 times coding without contact loss
- NEW: Larger termination cross section for conductors 0.25 - 1.5 mm<sup>2</sup>

### Technical characteristics

Locking	PushPull technology acc. to IEC 61 076-3-117 variant 14
Mating face	acc. to IEC 61 076-3-118
Degree of protection	IP 65 / IP 67
Number of contacts	4 + PE
Electrical data	
acc. to DIN EN 61 984	16 A 690 V 4 kV 3
Termination cross section	0.25 – 2.5 mm <sup>2</sup>
Mating cycles	min. 500
Temperature range	-40 °C ... +70 °C
Housing material	Plastic, black
Flammability acc. to UL 94	V 0

Identification	Part No.	Drawing	Dimensions in mm
----------------	----------	---------	------------------

#### Han® PushPull Power 4/0 Panel feed-through

5-poles, 690 V / 16 A  
incl. bulkhead housing and male insert

with crimp termination  
(Order crimp male contacts separately)

09 35 231 0331

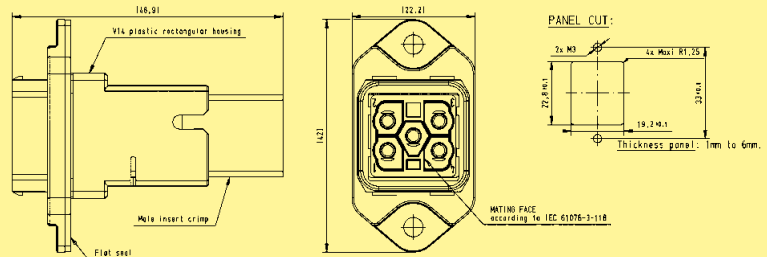

with Han-Quick Lock® termination

0.5 ... 2.5 mm<sup>2</sup>  
0.25 ... 1.5 mm<sup>2</sup>

09 35 232 0331  
09 35 234 0331

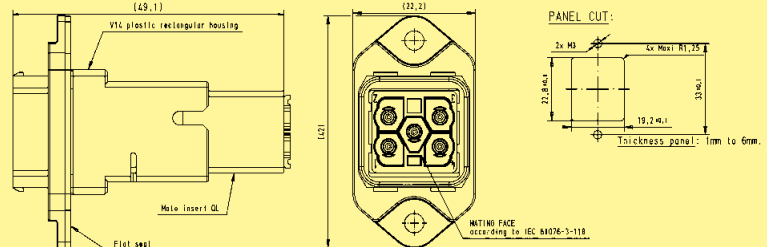

#### Coding element

10 pieces each for device and cable side  
enables 4 times coding without contact loss

09 35 000 6190

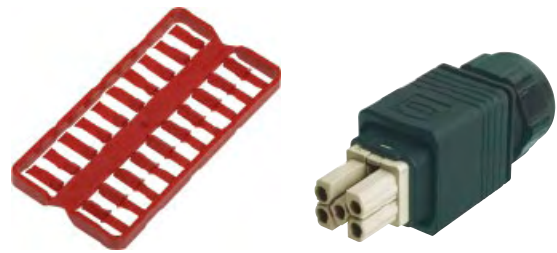

Han® PushPull, type acc. to IEC 61 076-3-118  
 Connector, 5-poles, 230/400 V, 16 A

### Features

- HARTING PushPull technology
- Compact, space-saving design
- Touch-proof
- Cable side: female
  - crimp termination
  - Han-Quick Lock® termination technology
 Field-assembly without special tools
- 4 times coding without contact loss
- NEW: Larger termination cross section for conductors 0.25 - 1.5 mm<sup>2</sup>

### Technical characteristics

Locking	PushPull technology acc. to IEC 61 076-3-117 variant 14 acc. to IEC 61 076-3-118
Mating face	acc. to IEC 61 076-3-118
Degree of protection	IP 65 / IP 67
Number of contacts	4 + PE
Electrical data	16 A 690 V 4 kV 3
acc. to DIN EN 61 984	0.25 – 2.5 mm <sup>2</sup>
Termination cross section	min. 500
Mating cycles	-40 °C ... +70 °C
Temperature range	Plastic, black
Housing material	V 0
Flammability acc. to UL 94	

Identification	Part No.	Drawing	Dimensions in mm
----------------	----------	---------	------------------

#### Connector set, plastic

incl. housing and female insert

with crimp termination  
 9 – 13 mm clamp range  
 Han® P crimp contacts  
 order separately

09 35 231 0423

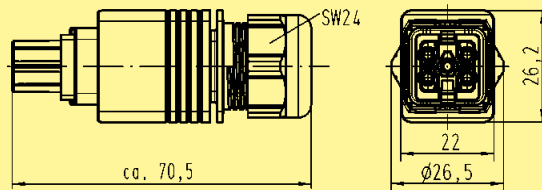

with Han-Quick Lock® termination  
 9 – 13 mm clamp range  
 for termination cross section 0.5 - 2.5 mm<sup>2</sup>

09 35 232 0423

with Han-Quick Lock® termination  
 6.5 – 9.5 mm clamp range  
 for termination cross section 0.5 - 2.5 mm<sup>2</sup>  
 for termination cross section 0.25 - 1.5 mm<sup>2</sup>

09 35 232 0421  
 09 35 234 0421

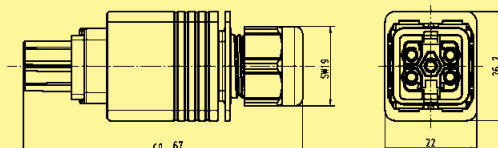

Dust protection cover IP 40

09 35 002 5412

Protection cover IP 65 / IP 67

09 35 002 5411

Coding pins

09 35 000 6190





Han® PushPull, type acc. to IEC 61 076-3-118  
Housing bulkhead mounting and power females for device integration

PushPull

## Features

- HARTING PushPull technology
- Compact, space-saving design
- Touch-proof
- Device side: male
  - Solder variant, angled and straight
- 4 times coding without contact loss

## Technical characteristics

Locking	PushPull technology acc. to IEC 61 076-3-118
Degree of protection	IP 65 / IP 67
Number of contacts	4 + PE
Electrical data acc. to DIN EN 61 984	16 A 230/400 V 4 kV 3
Termination	Male insert with solder termination
Mating cycles	min. 500
Temperature range	-40 °C ... +70 °C
Flammability acc. to UL 94	V 0
Housing material	Zinc die-cast, nickel plated Plastic, black (female)

Identification	Part No.	Drawing	Dimensions in mm
----------------	----------	---------	------------------

### Components device side

Housing bulkhead mounting metal	09 35 002 0303	
Dust protection cover IP 40, rubber (NBR)	09 35 002 5401	
Protection cover IP 65 / IP 67	09 35 002 5402	
Coding pins	09 35 000 6190	
Male insert with solder termination angled	09 35 002 3003	
Male insert with solder termination straight	09 35 002 3004	

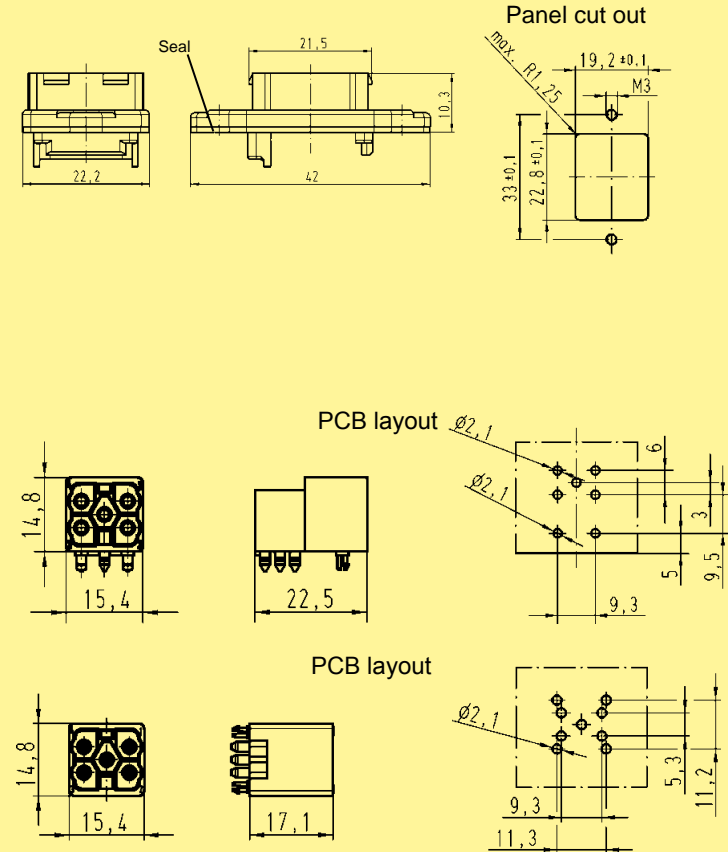



available  
Q2 / 2012



Han® PushPull, type acc. to IEC 61 076-3-118  
Panel feed-through, 5-poles, 16 A

Features

- HARTING PushPull technology
- Compact, space-saving design
- Touch-proof
- Panel feed-through: male
  - crimp termination
  - Han-Quick Lock® termination technology
- 4 times coding without contact loss
- NEW: Larger termination cross section for conductors 0.25 - 1.5 mm<sup>2</sup>

Technical characteristics

Locking	PushPull technology acc. to IEC 61 076-3-117 variant 14 acc. to IEC 61 076-3-118
Mating face	acc. to IEC 61 076-3-118
Degree of protection	IP 65 / IP 67
Number of contacts	4 + PE
Electrical data	16 A 690 V 4 kV 3
acc. to DIN EN 61 984	0.25 – 2.5 mm <sup>2</sup>
Termination cross section	min. 500
Mating cycles	-40 °C ... +70 °C
Temperature range	Zinc die-cast, nickel-plated
Housing material	V 0
Flammability acc. to UL 94	

Identification	Part No.	Drawing	Dimensions in mm
<p><b>Han® PushPull Power 4/0</b> <b>Panel feed-through</b> 5-poles, 690 V / 16 A incl. bulkhead housing and male insert</p> <p>Rectangular panel cut out with crimp termination (Order crimp male contacts separately)</p> <p>with Han-Quick Lock® termination 0.5 ... 2.5 mm<sup>2</sup> 0.25 ... 1.5 mm<sup>2</sup></p>	<p>09 35 231 0311</p> <p>09 35 232 0311</p> <p>09 35 234 0311</p>		<p>PANEL CUT: 4x Maxi 91,25 2x M3 27,8±0,1 19,2±0,1 Thickness panel: 1mm to 6mm. M3 screwing torque: 0.3 to 0.5 N.m.</p>
<p>Circular panel cut out with crimp termination (Order crimp male contacts separately)</p> <p>with Han-Quick Lock® termination 0.5 ... 2.5 mm<sup>2</sup> 0.25 ... 1.5 mm<sup>2</sup></p>	<p>09 35 231 0312</p> <p>09 35 232 0312</p> <p>09 35 234 0312</p>		<p>PANEL CUT: 11.8° ø28±. Thickness panel: 1mm to 6mm. M3 screwing torque: 2.5 to 3N.m.</p>
<p><b>Coding element</b> 10 pieces each for device and cable side enables 4 times coding without contact loss</p>	<p>09 35 000 6190</p>		



Han® PushPull, type acc. to IEC 61 076-3-118  
Connector, 5-poles, 16 A

PushPull

**Features**

- HARTING PushPull technology
- Compact, space-saving design
- Touch-proof
- Cable side: female
  - crimp termination
  - Han-Quick Lock® termination technology
 Field-assembly without special tools
- 4 times coding without contact loss
- NEW: Larger termination cross section for conductors 0.25 - 1.5 mm<sup>2</sup>

**Technical characteristics**

Locking	PushPull technology acc. to IEC 61 076-3-117 variant 14 acc. to IEC 61 076-3-118
Mating face	acc. to IEC 61 076-3-118
Degree of protection	IP 65 / IP 67
Number of contacts	4 + PE
Electrical data	16 A 690 V 4 kV 3
acc. to DIN EN 61 984	0.25 – 2.5 mm <sup>2</sup>
Termination cross section	min. 500
Mating cycles	-40 °C ... +70 °C
Temperature range	Zinc die-cast, nickel-plated
Housing material	V 0
Flammability acc. to UL 94	

Identification	Part No.	Drawing	Dimensions in mm
----------------	----------	---------	------------------

**Connector set, metal**

incl. housing and female insert

with crimp termination  
4 – 11 mm clamp range  
Han® P crimp contacts  
order separately

09 35 231 0401

with Han-Quick Lock® termination  
4 – 11 mm clamp range  
for termination cross section 0.5 - 2.5 mm<sup>2</sup>  
for termination cross section 0.25 - 1.5 mm<sup>2</sup>

09 35 232 0401  
09 35 234 0401

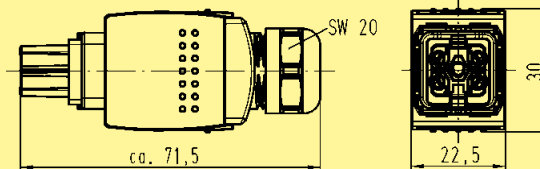

Dust protection cover IP 40

09 35 002 5412



Protection cover IP 65 / IP 67

09 35 002 5411

Coding pins

09 35 000 6190

## Han® PushPull, type acc. to IEC 61 076-3-118 variant 14 Accessories

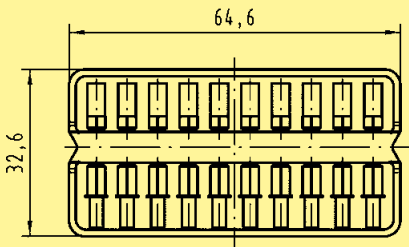
Identification	Part No.	Drawing	Dimensions in mm
BUCHANAN-crimping tool	09 99 000 0001		
Locator Han P® for crimping tool 09 99 000 0001	09 99 000 0329		
Multiple crimping tool depth adjustment gauge	09 99 000 0379	Wire gauge 0.5 - 1 mm <sup>2</sup> ø 1.55 1.5 - 2.5 mm <sup>2</sup> ø 1.80	
Removal tool Han P®	09 99 000 0319		
Coding pins for 4 times coding without contact loss	09 35 000 6190		

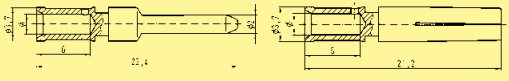
Identification	Part No.		Drawing	Dimensions in mm																								
	Male contact	Female contact																										
Crimp contacts Han® P silver plated																												
	for 0.5 mm <sup>2</sup>	09 35 000 6103		09 35 000 6203																								
	for 0.75 mm <sup>2</sup>	09 35 000 6104		09 35 000 6204																								
	for 1.0 mm <sup>2</sup>	09 35 000 6105		09 35 000 6205																								
	for 1.5 mm <sup>2</sup>	09 35 000 6106		09 35 000 6206																								
	for 2.5 mm <sup>2</sup>	09 35 000 6107		09 35 000 6207																								
			<table border="1"> <thead> <tr> <th colspan="2">Wire gauge</th> <th>Ø</th> <th>Stripping length</th> </tr> </thead> <tbody> <tr> <td>for 0.5 mm<sup>2</sup></td> <td>AWG 20</td> <td>1.15 mm</td> <td>6 mm</td> </tr> <tr> <td>for 0.75 mm<sup>2</sup></td> <td>AWG 18</td> <td>1.30 mm</td> <td>6 mm</td> </tr> <tr> <td>for 1.0 mm<sup>2</sup></td> <td>AWG 18</td> <td>1.45 mm</td> <td>6 mm</td> </tr> <tr> <td>for 1.5 mm<sup>2</sup></td> <td>AWG 16</td> <td>1.75 mm</td> <td>6 mm</td> </tr> <tr> <td>for 2.5 mm<sup>2</sup></td> <td>AWG 14</td> <td>2.25 mm</td> <td>6 mm</td> </tr> </tbody> </table>	Wire gauge		Ø	Stripping length	for 0.5 mm <sup>2</sup>	AWG 20	1.15 mm	6 mm	for 0.75 mm <sup>2</sup>	AWG 18	1.30 mm	6 mm	for 1.0 mm <sup>2</sup>	AWG 18	1.45 mm	6 mm	for 1.5 mm <sup>2</sup>	AWG 16	1.75 mm	6 mm	for 2.5 mm <sup>2</sup>	AWG 14	2.25 mm	6 mm	
Wire gauge		Ø	Stripping length																									
for 0.5 mm <sup>2</sup>	AWG 20	1.15 mm	6 mm																									
for 0.75 mm <sup>2</sup>	AWG 18	1.30 mm	6 mm																									
for 1.0 mm <sup>2</sup>	AWG 18	1.45 mm	6 mm																									
for 1.5 mm <sup>2</sup>	AWG 16	1.75 mm	6 mm																									
for 2.5 mm <sup>2</sup>	AWG 14	2.25 mm	6 mm																									

available  
Q2 / 2012



Han® PushPull, type acc. to IEC 61 076-3-117 variant 14  
cable to cable housing

PushPull

## Features

- HARTING PushPull technology
- Ideal for prototyping
- Can be combined with panel feed-throughs for power, data and signal

## Technical characteristics

Locking	PushPull technology acc. to IEC 61 076-3-117 variant 14
Degree of protection	IP 65 / IP 67
Outer cable diameter	6.5 ... 9.5 mm / 9 ... 13 mm
Mating cycles	min. 750
Temperature range	-40 °C ... +70 °C
Housing material	Plastic, black
Flammability acc. to UL 94	V 0

Identification	Part No.	Drawing	Dimensions in mm
<b>Han® PushPull cable to cable housings, plastic</b> (Order housing bulkhead mounting and insert separately)			
for outer cable diameter 6.5 ... 9.5 mm	09 35 002 0431	2X REMFORM $\phi 3 \times 8$ TORX screws 	
for outer cable diameter 9 ... 13 mm	09 35 002 0433	2X REMFORM $\phi 3 \times 8$ TORX screws 	
<b>Suitable bulkhead housing, plastic</b>  for power, 5-poles, 690 V / 16 A, incl. housing bulkhead mounting and insert  with crimp termination (Order Han® P crimp male contacts separately)	09 35 231 0331		
with Han-Quick Lock® termination			
0.5 ... 2.5 mm <sup>2</sup>	09 35 232 0331		
0.25 ... 1.5 mm <sup>2</sup>	09 35 234 0331		
<b>Coding element power</b> 10 pieces each for device and cable side	09 35 000 6190		



Housing bulkhead mounting and power females for device integration

## Features

- HARTING PushPull technology
- Touch-proof
- Device side: male
  - Solder variant, angled and straight
- AIDA-conform (German Domestic Automobile Manufactures)

## Technical characteristics

Locking	PushPull technology
Degree of protection	IP 65 / IP 67
Number of contacts	4 + PE
Electrical data	16 A 24 V 4 kV 3
acc. to DIN EN 61 984	Male insert with solder termination
Termination	min. 500
Mating cycles	-40 °C ... +70 °C
Temperature range	Plastic, black
Housing material	V 0
Flammability acc. to UL 94	

Identification	Part No.	Drawing	Dimensions in mm
<b>Components device side</b>  Housing bulkhead mounting plastic	09 35 004 0321		Panel cut out 
Male insert with solder termination angled	09 35 004 3003		
Male insert with solder termination straight	09 35 004 3004		
Panel feed-through, plastic incl. housing and male insert with spring force connection	09 35 431 0331		
Protection cover IP 65 / IP 67	09 35 004 5401		



Connector, 5-poles, 24 V, 16 A

PushPull

## Features

- HARTING PushPull technology
- Touch-proof
- Cable side: female
  - spring force connection
- AIDA-conform  
(German Domestic Automobile Manufactures)

## Technical characteristics

Locking	PushPull technology
Degree of protection	IP 65 / IP 67
Number of contacts	4 + PE
Electrical data	
acc. to DIN EN 61 984	16 A 24 V 4 kV 3
Termination	Spring force connection
Termination cross section	0.75 ... 2.5 mm <sup>2</sup>
Mating cycles	min. 500
Temperature range	-40 °C ... +70 °C
Cable diameter	9 – 13 mm
Housing material	Plastic, black
Flammability acc. to UL 94	V 0

Identification

Part No.

Drawing

Dimensions in mm

### Connector set, plastic

incl. housing  
and female insert  
with spring force connection

09 35 431 0421

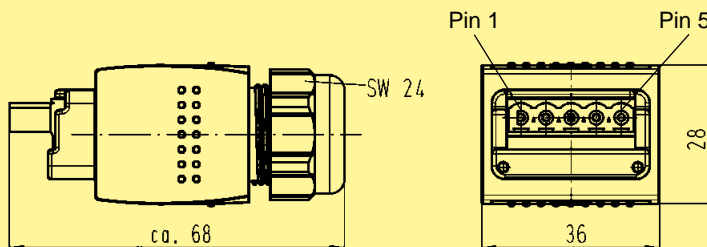



Housing bulkhead mounting and power females for device integration

## Features

- HARTING PushPull technology
- Touch-proof
- Device side: male
  - Solder variant, angled and straight
- AIDA-conform (German Domestic Automobile Manufactures)

## Technical characteristics

Locking	PushPull technology
Degree of protection	IP 65 / IP 67
Number of contacts	4 + PE
Electrical data	16 A 24 V 4 kV
acc. to DIN EN 61 984	Male insert with solder termination
Termination	min. 500
Mating cycles	-40 °C ... +70 °C
Temperature range	Zinc die-cast, nickel plated
Housing material	Plastic, black (female)

### Identification

### Part No.

### Drawing

### Dimensions in mm

#### Components device side

Housing bulkhead mounting metal

09 35 004 0301

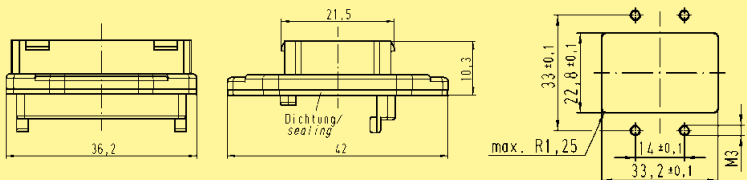

Male insert with solder termination angled

09 35 004 3003

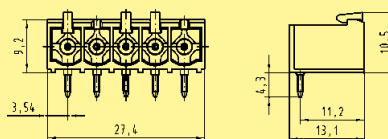

Male insert with solder termination straight

09 35 004 3004

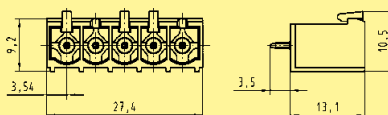

Panel feed-through, metal

incl. housing and male insert with spring force connection

09 35 431 0311

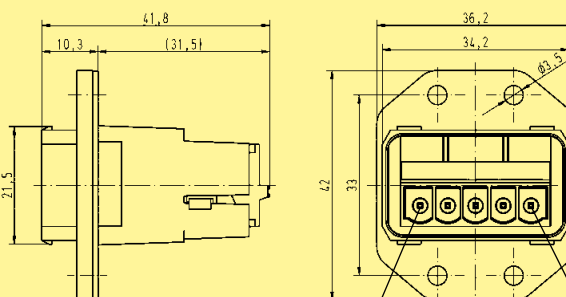

Protection cover IP 65 / IP 67

09 35 004 5401

Pin 1 Pin 5

PushPull





## Han® PushPull L Power 4/0 Genderchanger Metal

### Features

- High degree of protection IP 65 / IP 67
- Robust metal housing
- Standard PROFINET component of the German automotive production
- Allows usage of different cable types (Type B,C) e.g. in robots application
- Extension of cords according to PROFINET guideline

### Technical characteristics

Connector	Han® PushPull L Power 4/0
Locking	PushPull technology
Electrical transmission	16 A / 24 V
Number of contacts	5
Mating cycles	min. 500
Housing material	Aluminium anodized
Dimensions	83.4 x 62 x 40.7 mm (unmated)
Degree of protection acc. to DIN 60529	IP 65 / IP 67 (mated)
Mounting	Wall mountable with 4 screws (type M5)
Temperature range	-20 °C ... +50 °C
Maximum permissible humidity	30 % ... 95 % (no condensation)

#### Identification

#### Part No.

#### Drawing

#### Dimensions in mm

#### Han® PushPull L Power 4/0 Genderchanger metal

including housing and printed board with 2 x male insert with solder termination

09 35 431 0501

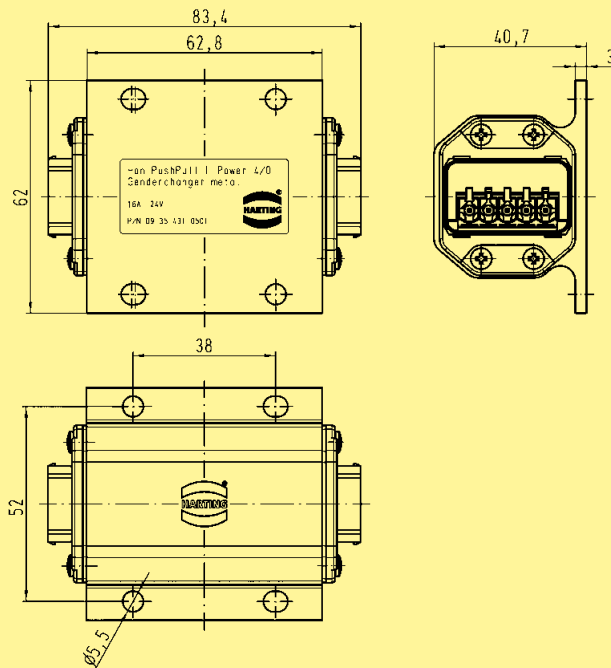



Connector, 5-poles, 24 V, 16 A

## Features

- HARTING PushPull technology
- Touch-proof
- Cable side: female
  - spring force connection
- AIDA-conform  
(German Domestic Automobile Manufactures)

## Technical characteristics

Locking	PushPull technology
Degree of protection	IP 65 / IP 67
Number of contacts	4 + PE
Electrical data	
acc. to DIN EN 61 984	16 A 24 V 4 kV 3
Termination	Spring force connection
Termination cross section	0.75 ... 2.5 mm <sup>2</sup>
Mating cycles	min. 500
Temperature range	-40 °C ... +70 °C
Cable diameter	9 – 13 mm
Housing material	Zinc die-cast, nickel plated

Identification

Part No.

Drawing

Dimensions in mm

### Connector set, metal

incl. housing  
and female insert  
with spring force connection

09 35 431 0401

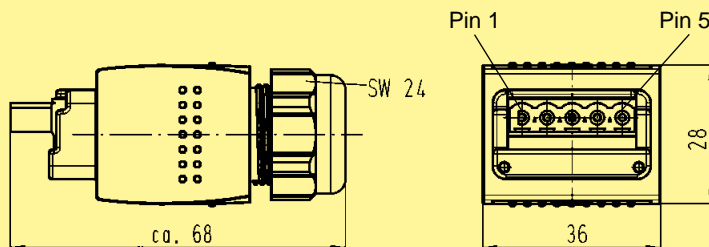

PushPull

# AMEYA360

## Components Supply Platform

### Authorized Distribution Brand :



### Website :

Welcome to visit [www.ameya360.com](http://www.ameya360.com)

### Contact Us :

#### ➤ Address :

401 Building No.5, JiuGe Business Center, Lane 2301, Yishan Rd  
Minhang District, Shanghai , China

#### ➤ Sales :

Direct +86 (21) 6401-6692

Email [amall@ameya360.com](mailto:amall@ameya360.com)

QQ 800077892

Skype [ameyasales1](#) [ameyasales2](#)

#### ➤ Customer Service :

Email [service@ameya360.com](mailto:service@ameya360.com)

#### ➤ Partnership :

Tel +86 (21) 64016692-8333

Email [mkt@ameya360.com](mailto:mkt@ameya360.com)