

# LMZ14203 3A SIMPLE SWITCHER® Power Module with 42V Maximum Input Voltage

 Check for Samples: [LMZ14203](#)

## KEY FEATURES

- Integrated Shielded Inductor
- Simple PCB Layout
- Flexible Startup Sequencing Using External Soft-start and Precision Enable
- Protection Against Inrush Currents and Faults such as Input UVLO and Output Short Circuit
- –40°C to 125°C Junction Temperature Range
- Single Exposed Pad and Standard Pinout for Easy Mounting and Manufacturing
- Fast Transient Response for Powering FPGAs and ASICs
- Low Output Voltage Ripple
- Pin-to-pin Compatible Family:
  - LMZ14203/2/1 (42V Max 3A, 2A, 1A)
  - LMZ12003/2/1 (20V Max 3A, 2A, 1A)
- Fully Enabled for Webench® Power Designer

## APPLICATIONS

- Point of Load Conversions from 12V and 24V Input Rail
- Time Critical Projects
- Space Constrained / High Thermal Requirement Applications
- Negative Output Voltage Applications (See AN-2027 [SNVA425](#))

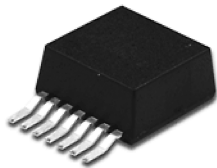

Top View

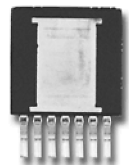

Bottom View

**Figure 1. Easy To Use 7 Pin Package**  
 10.16 x 13.77 x 4.57 mm (0.4 x 0.542 x 0.18 in)  
 $\theta_{JA} = 20^{\circ}\text{C/W}$ ,  $\theta_{JC} = 1.9^{\circ}\text{C/W}$   
 RoHS Compliant  
 Peak Reflow Case Temp = 245°C  
[Power Module SMT Guidelines](#)

## DESCRIPTION

The LMZ14203 SIMPLE SWITCHER® power module is an easy-to-use step-down DC-DC solution capable of driving up to 3A load with exceptional power conversion efficiency, line and load regulation, and output accuracy. The LMZ14203 is available in an innovative package that enhances thermal performance and allows for hand or machine soldering.

The LMZ14203 can accept an input voltage rail between 6V and 42V and deliver an adjustable and highly accurate output voltage as low as 0.8V. The LMZ14203 only requires three external resistors and four external capacitors to complete the power solution. The LMZ14203 is a reliable and robust design with the following protection features: thermal shutdown, input under-voltage lockout, output over-voltage protection, short-circuit protection, output current limit, and allows startup into a pre-biased output. A single resistor adjusts the switching frequency up to 1 MHz.

## ELECTRICAL SPECIFICATIONS

- 18W Maximum Total Output Power
- Up to 3A Output Current
- Input voltage Range 6V to 42V
- Output Voltage Range 0.8V to 6V
- Efficiency up to 90%

## PERFORMANCE BENEFITS

- Operates at High Ambient Temperature with no Thermal Derating
- High Efficiency Reduces System Heat Generation
- Low Radiated Emissions (EMI) Complies with EN55022 Class B Standard
- Passes 10V/m Radiated Immunity EMI Test Standard EN61000 4-3



Please be aware that an important notice concerning availability, standard warranty, and use in critical applications of Texas Instruments semiconductor products and disclaimers thereto appears at the end of this data sheet.

All trademarks are the property of their respective owners.

**System Performance**

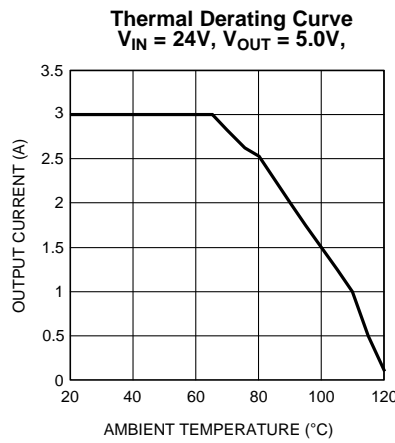
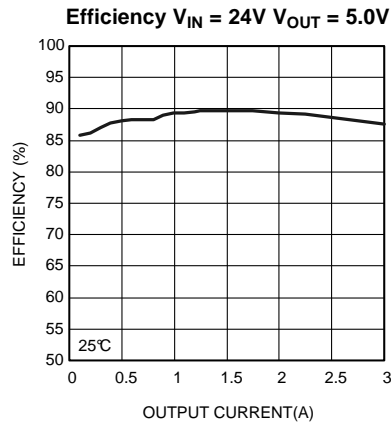

**Radiated Emissions (EN 55022 Class B)  
from Evaluation Board**

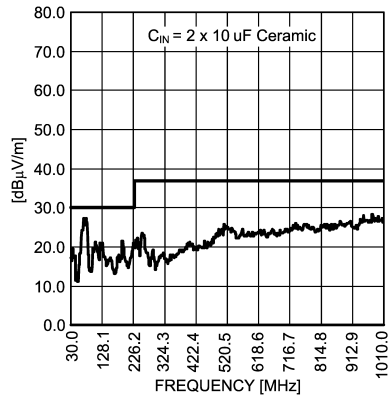

### Simplified Application Schematic

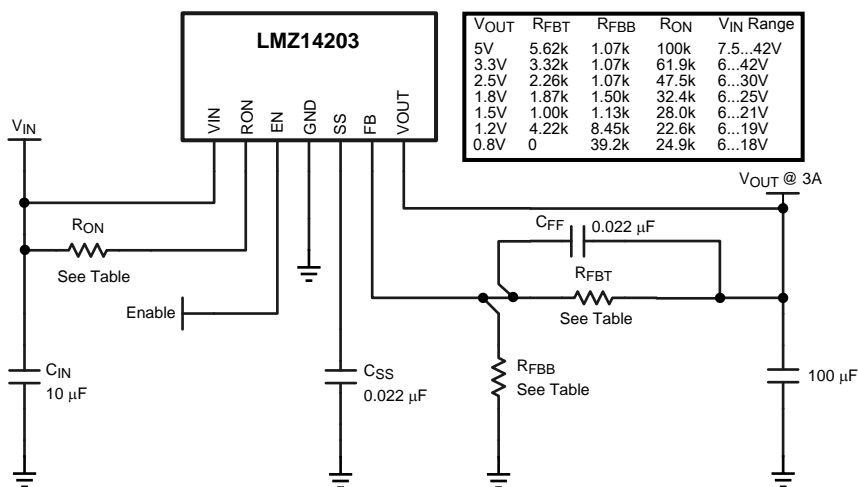

### Connection Diagram

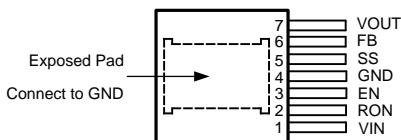

Figure 2. Top View 7-Lead PFM

### Pin Descriptions

Pin	Name	Description
1	VIN	Supply input — Nominal operating range is 6V to 42V . A small amount of internal capacitance is contained within the package assembly. Additional external input capacitance is required between this pin and exposed pad.
2	RON	On Time Resistor — An external resistor from VIN to this pin sets the on-time of the application. Typical values range from 25k to 124k ohms.
3	EN	Enable — Input to the precision enable comparator. Rising threshold is 1.18V nominal; 90 mV hysteresis nominal. Maximum recommended input level is 6.5V.
4	GND	Ground — Reference point for all stated voltages. Must be externally connected to EP.
5	SS	Soft-Start — An internal 8 μA current source charges an external capacitor to produce the soft-start function. This node is discharged at 200 μA during disable, over-current, thermal shutdown and internal UVLO conditions.
6	FB	Feedback — Internally connected to the regulation, over-voltage, and short-circuit comparators. The regulation reference point is 0.8V at this input pin. Connected the feedback resistor divider between the output and ground to set the output voltage.
7	VOUT	Output Voltage — Output from the internal inductor. Connect the output capacitor between this pin and exposed pad.
EP	EP	Exposed Pad — Internally connected to pin 4. Used to dissipate heat from the package during operation. Must be electrically connected to pin 4 external to the package.



These devices have limited built-in ESD protection. The leads should be shorted together or the device placed in conductive foam during storage or handling to prevent electrostatic damage to the MOS gates.

## Absolute Maximum Ratings <sup>(1)(2)</sup>

V <sub>IN</sub> , RON to GND	-0.3V to 43.5V
EN, FB, SS to GND	-0.3V to 7V
Junction Temperature	150°C
Storage Temperature Range	-65°C to 150°C
ESD Susceptibility <sup>(3)</sup>	± 2 kV
Peak Reflow Case Temperature (30 sec)	245°C
For soldering specifications, refer to the following document: <a href="http://www.ti.com/lit/snoa549c">www.ti.com/lit/snoa549c</a>	

- (1) Absolute Maximum Ratings are limits beyond which damage to the device may occur. Operating Ratings are conditions under which operation of the device is intended to be functional. For ensured specifications and test conditions, see the Electrical Characteristics.
- (2) If Military/Aerospace specified devices are required, please contact the Texas Instruments Sales Office/ Distributors for availability and specifications.
- (3) The human body model is a 100pF capacitor discharged through a 1.5 kΩ resistor into each pin. Test method is per JESD-22-114.

## Operating Ratings <sup>(1)</sup>

V <sub>IN</sub>	6V to 42V
EN	0V to 6.5V
Operation Junction Temperature	-40°C to 125°C

- (1) Absolute Maximum Ratings are limits beyond which damage to the device may occur. Operating Ratings are conditions under which operation of the device is intended to be functional. For ensured specifications and test conditions, see the Electrical Characteristics.

## Electrical Characteristics

Limits in standard type are for T<sub>J</sub> = 25°C only; limits in boldface type apply over the junction temperature (T<sub>J</sub>) range of -40°C to +125°C. Minimum and Maximum limits are ensured through test, design or statistical correlation. Typical values represent the most likely parametric norm at T<sub>J</sub> = 25°C, and are provided for reference purposes only. Unless otherwise stated the following conditions apply: V<sub>IN</sub> = 24V, V<sub>out</sub> = 3.3V

Symbol	Parameter	Conditions	Min (1)	Typ (2)	Max (1)	Units
<b>SYSTEM PARAMETERS</b>						
<b>Enable Control <sup>(3)</sup></b>						
V <sub>EN</sub>	EN threshold trip point	V <sub>EN</sub> rising	<b>1.1</b>	1.18	<b>1.25</b>	V
V <sub>EN-HYS</sub>	EN threshold hysteresis	V <sub>EN</sub> falling		90		mV
<b>Soft-Start</b>						
I <sub>SS</sub>	SS source current	V <sub>SS</sub> = 0V	<b>5</b>	8	<b>11</b>	μA
I <sub>SS-DIS</sub>	SS discharge current			-200		μA
<b>Current Limit</b>						
I <sub>CL</sub>	Current limit threshold	d.c. average V <sub>IN</sub> = 12V to 24V	<b>3.2</b>	4.2	<b>5.25</b>	A
<b>ON/OFF Timer</b>						
t <sub>ON-MIN</sub>	ON timer minimum pulse width			150		ns
t <sub>OFF</sub>	OFF timer pulse width			260		ns
<b>Regulation and Over-Voltage Comparator</b>						
V <sub>FB</sub>	In-regulation feedback voltage	V <sub>SS</sub> >+ 0.8V T <sub>J</sub> = -40°C to 125°C I <sub>O</sub> = 3A	<b>0.784</b>	0.804	<b>0.825</b>	V
		V <sub>SS</sub> >+ 0.8V T <sub>J</sub> = 25°C I <sub>O</sub> = 10 mA	0.786	0.802	0.818	V
V <sub>FB-OV</sub>	Feedback over-voltage protection threshold			0.92		V

- (1) Min and Max limits are 100% production tested at 25°C. Limits over the operating temperature range are ensured through correlation using Statistical Quality Control (SQC) methods. Limits are used to calculate Average Outgoing Quality Level (AOQL).
- (2) Typical numbers are at 25°C and represent the most likely parametric norm.
- (3) EN 55022:2006, +A1:2007, FCC Part 15 Subpart B: 2007. See AN-2024 and layout for information on device under test.

## Electrical Characteristics (continued)

Limits in standard type are for  $T_J = 25^\circ\text{C}$  only; limits in boldface type apply over the junction temperature ( $T_J$ ) range of  $-40^\circ\text{C}$  to  $+125^\circ\text{C}$ . Minimum and Maximum limits are ensured through test, design or statistical correlation. Typical values represent the most likely parametric norm at  $T_J = 25^\circ\text{C}$ , and are provided for reference purposes only. Unless otherwise stated the following conditions apply:  $V_{IN} = 24\text{V}$ ,  $V_{out} = 3.3\text{V}$

Symbol	Parameter	Conditions	Min (1)	Typ (2)	Max (1)	Units
$I_{FB}$	Feedback input bias current			5		nA
$I_Q$	Non Switching Input Current	$V_{FB} = 0.86\text{V}$		1		mA
$I_{SD}$	Shut Down Quiescent Current	$V_{EN} = 0\text{V}$		25		$\mu\text{A}$
<b>Thermal Characteristics</b>						
$T_{SD}$	Thermal Shutdown	Rising		165		$^\circ\text{C}$
$T_{SD-HYST}$	Thermal shutdown hysteresis	Falling		15		$^\circ\text{C}$
$\theta_{JA}^{(4)}$	Junction to Ambient	4 layer JEDEC Printed Circuit Board, 100 vias, No air flow		19.3		$^\circ\text{C}/\text{W}$
		2 layer JEDEC Printed Circuit Board, No air flow		21.5		$^\circ\text{C}/\text{W}$
$\theta_{JC}$	Junction to Case	No air flow		1.9		$^\circ\text{C}/\text{W}$
<b>PERFORMANCE PARAMETERS</b>						
$\Delta V_O$	Output Voltage Ripple			8		mV <sub>PP</sub>
$\Delta V_O/\Delta V_{IN}$	Line Regulation	$V_{IN} = 12\text{V to } 42\text{V}$ , $I_O = 3\text{A}$		.01		%
$\Delta V_O/I_{OUT}$	Load Regulation	$V_{IN} = 24\text{V}$		1.5		mV/A
$\eta$	Efficiency	$V_{IN} = 24\text{V}$ $V_O = 3.3\text{V}$ $I_O = 1\text{A}$		92		%
$\eta$	Efficiency	$V_{IN} = 24\text{V}$ $V_O = 3.3\text{V}$ $I_O = 3\text{A}$		85		%

(4)  $\theta_{JA}$  measured on a 1.705" x 3.0" four layer board, with one ounce copper, thirty five thermal vias, no air flow, and 1W power dissipation. Refer to PCB layout diagrams.

### Typical Performance Characteristics

Unless otherwise specified, the following conditions apply:  $V_{IN} = 24V$ ;  $C_{in} = 10\mu F$  X7R Ceramic;  $C_O = 100\mu F$  X7R Ceramic;  $T_{amb} = 25\text{ C}$  for efficiency curves and waveforms.

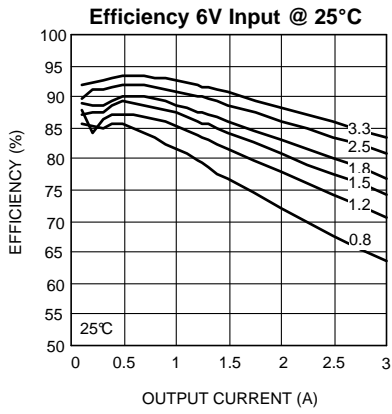

Figure 3.

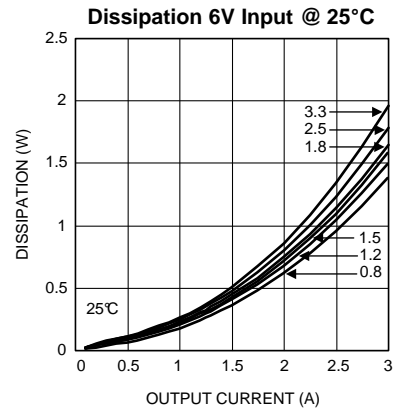

Figure 4.

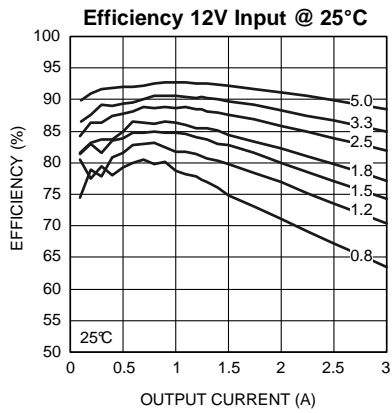

Figure 5.

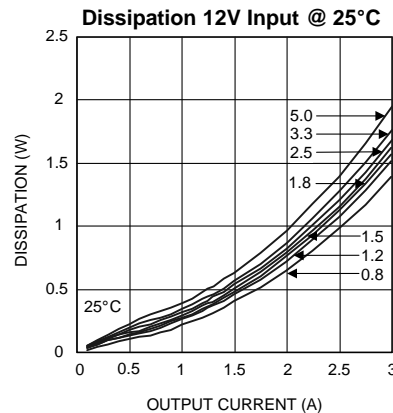

Figure 6.

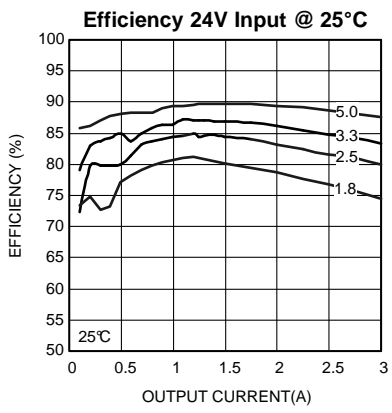

Figure 7.

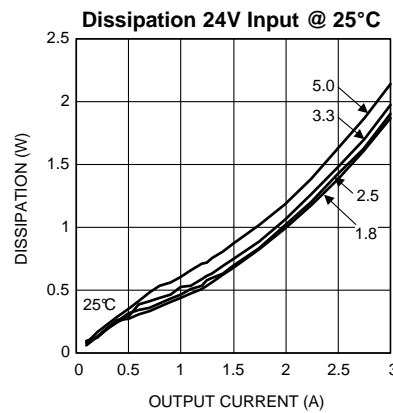

Figure 8.

### Typical Performance Characteristics (continued)

Unless otherwise specified, the following conditions apply:  $V_{IN} = 24V$ ;  $C_{in} = 10\mu F$  X7R Ceramic;  $C_O = 100\mu F$  X7R Ceramic;  $T_{ambient} = 25\text{ C}$  for efficiency curves and waveforms.

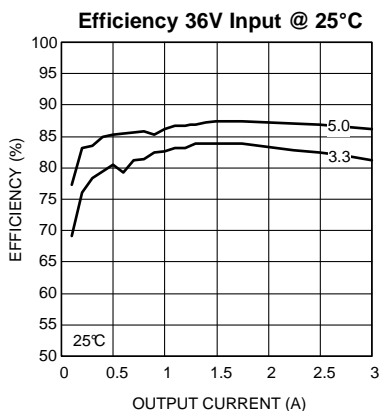

Figure 9.

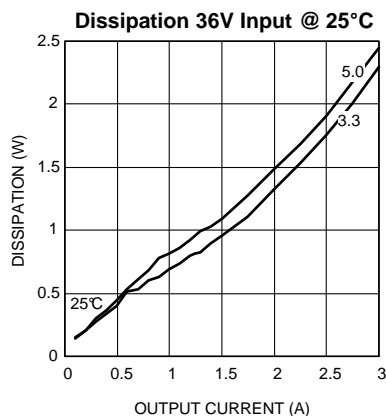

Figure 10.

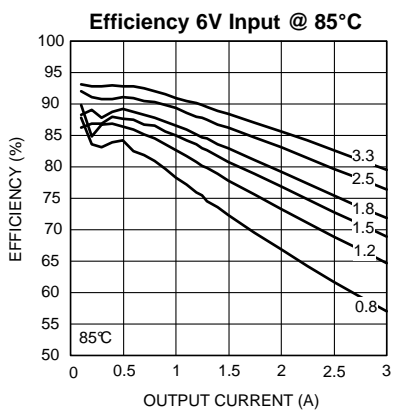

Figure 11.

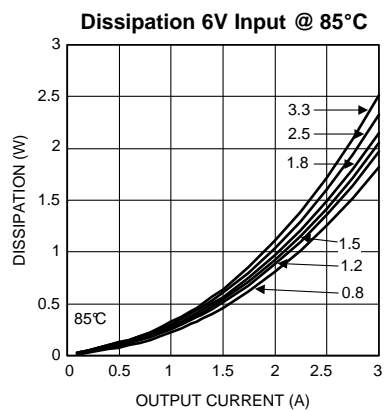

Figure 12.

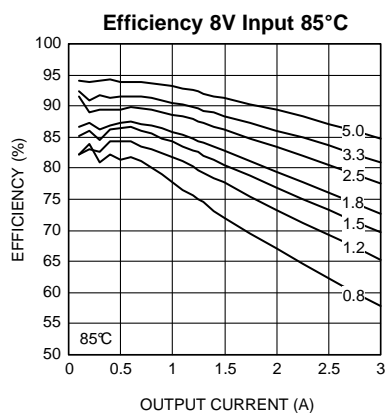

Figure 13.

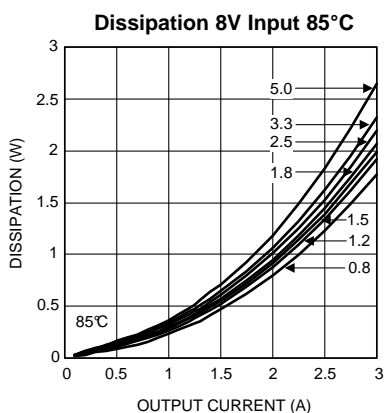

Figure 14.

### Typical Performance Characteristics (continued)

Unless otherwise specified, the following conditions apply:  $V_{IN} = 24V$ ;  $C_{in} = 10\mu F$  X7R Ceramic;  $C_O = 100\mu F$  X7R Ceramic;  $T_{ambient} = 25\text{ C}$  for efficiency curves and waveforms.

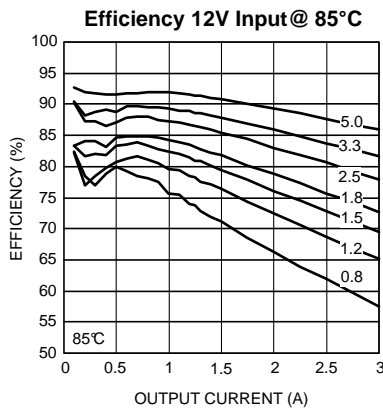

Figure 15.

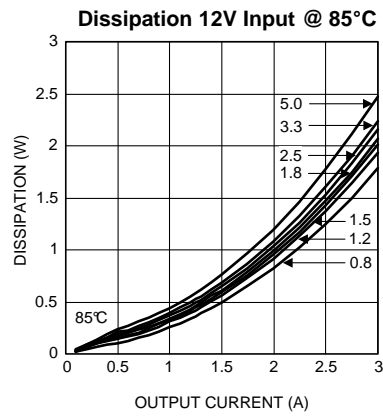

Figure 16.

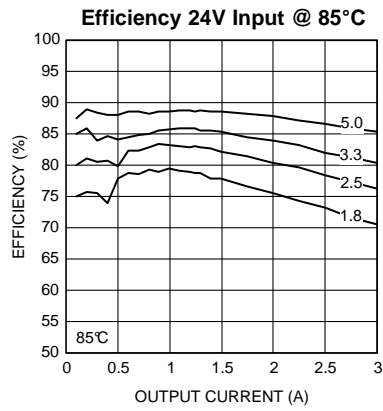

Figure 17.

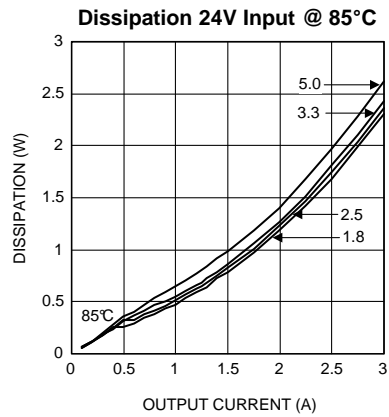

Figure 18.

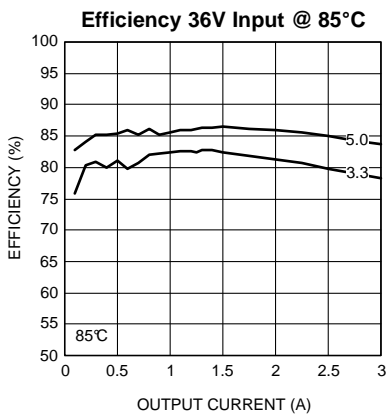

Figure 19.

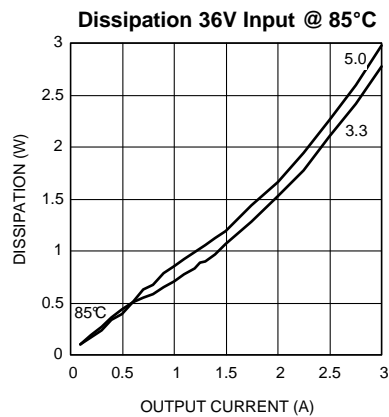

Figure 20.



### Typical Performance Characteristics (continued)

Unless otherwise specified, the following conditions apply:  $V_{IN} = 24V$ ;  $C_{in} = 10\mu F$  X7R Ceramic;  $C_O = 100\mu F$  X7R Ceramic;  $T_{ambient} = 25\text{ C}$  for efficiency curves and waveforms.

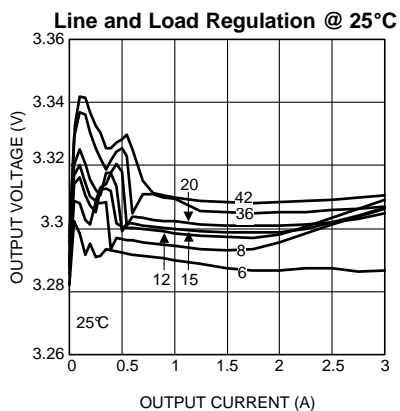

Figure 21.

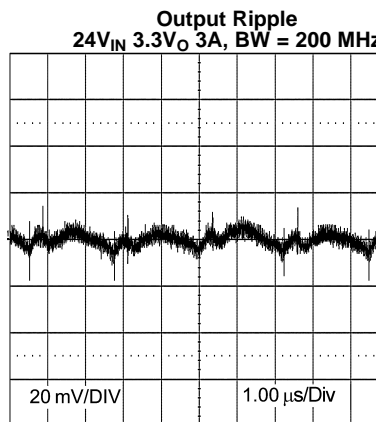

Figure 22.

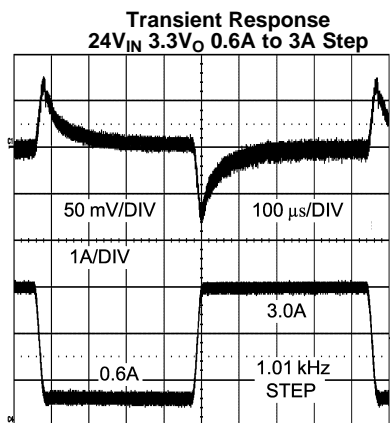

Figure 23.

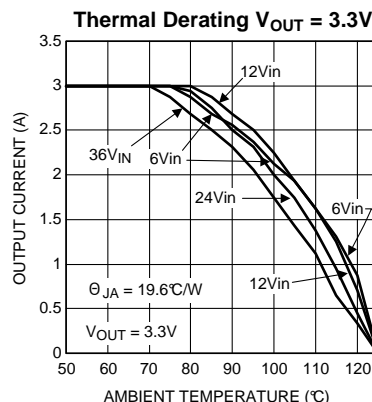
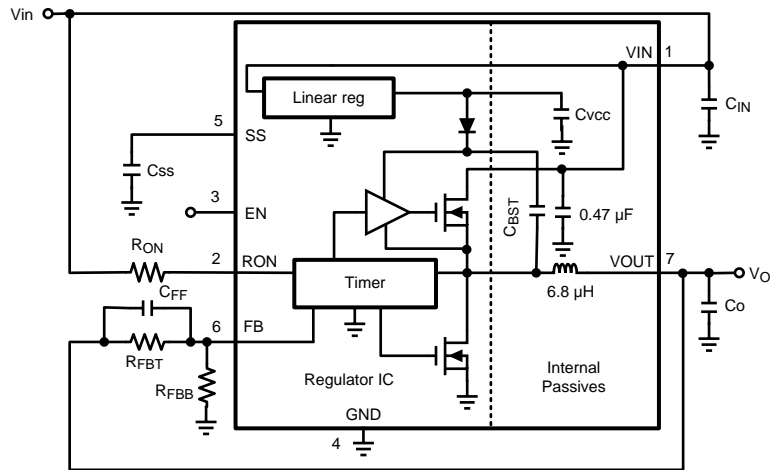

Figure 24.

APPLICATION BLOCK DIAGRAM



## COT CONTROL CIRCUIT OVERVIEW

Constant On Time control is based on a comparator and an on-time one shot, with the output voltage feedback compared with an internal 0.8V reference. If the feedback voltage is below the reference, the main MOSFET is turned on for a fixed on-time determined by a programming resistor  $R_{ON}$ .  $R_{ON}$  is connected to  $V_{IN}$  such that on-time is reduced with increasing input supply voltage. Following this on-time, the main MOSFET remains off for a minimum of 260 ns. If the voltage on the feedback pin falls below the reference level again the on-time cycle is repeated. Regulation is achieved in this manner.

### Design Steps for the LMZ14203 Application

The LMZ14203 is fully supported by Webench® and offers the following: Component selection, electrical and thermal simulations as well as the build-it board for a reduction in design time. The following list of steps can be used to manually design the LMZ14203 application.

- Select minimum operating  $V_{IN}$  with enable divider resistors
- Program  $V_O$  with divider resistor selection
- Program turn-on time with soft-start capacitor selection
- Select  $C_O$
- Select  $C_{IN}$
- Set operating frequency with  $R_{ON}$
- Determine module dissipation
- Layout PCB for required thermal performance

### ENABLE DIVIDER, $R_{ENT}$ AND $R_{ENB}$ SELECTION

The enable input provides a precise 1.18V band-gap rising threshold to allow direct logic drive or connection to a voltage divider from a higher enable voltage such as  $V_{IN}$ . The enable input also incorporates 90 mV (typ) of hysteresis resulting in a falling threshold of 1.09V. The maximum recommended voltage into the EN pin is 6.5V. For applications where the midpoint of the enable divider exceeds 6.5V, a small zener can be added to limit this voltage.

The function of this resistive divider is to allow the designer to choose an input voltage below which the circuit will be disabled. This implements the feature of programmable under voltage lockout. This is often used in battery powered systems to prevent deep discharge of the system battery. It is also useful in system designs for sequencing of output rails or to prevent early turn-on of the supply as the main input voltage rail rises at power-up. Applying the enable divider to the main input rail is often done in the case of higher input voltage systems such as 24V AC/DC systems where a lower boundary of operation should be established. In the case of sequencing supplies, the divider is connected to a rail that becomes active earlier in the power-up cycle than the LMZ14203 output rail. The two resistors should be chosen based on the following ratio:

$$R_{ENT} / R_{ENB} = (V_{IN\ UVLO} / 1.18V) - 1 \quad (1)$$

The LMZ14203 demonstration and evaluation boards use 11.8k $\Omega$  for  $R_{ENB}$  and 68.1k $\Omega$  for  $R_{ENT}$  resulting in a rising UVLO of 8V. This divider presents 6.25V to the EN input when the divider input is raised to 42V.

The EN pin is internally pulled up to  $V_{IN}$  and can be left floating for always-on operation.

### OUTPUT VOLTAGE SELECTION

Output voltage is determined by a divider of two resistors connected between  $V_O$  and ground. The midpoint of the divider is connected to the FB input. The voltage at FB is compared to a 0.8V internal reference. In normal operation an on-time cycle is initiated when the voltage on the FB pin falls below 0.8V. The main MOSFET on-time cycle causes the output voltage to rise and the voltage at the FB to exceed 0.8V. As long as the voltage at FB is above 0.8V, on-time cycles will not occur.

The regulated output voltage determined by the external divider resistors  $R_{FBT}$  and  $R_{FBB}$  is:

$$V_O = 0.8V * (1 + R_{FBT} / R_{FBB}) \quad (2)$$

Rearranging terms; the ratio of the feedback resistors for a desired output voltage is:

$$R_{FBT} / R_{FBB} = (V_O / 0.8V) - 1 \quad (3)$$

These resistors should be chosen from values in the range of 1.0 kohm to 10.0 kohm.

For  $V_O = 0.8V$  the FB pin can be connected to the output directly so long as an output preload resistor remains that draws more than 20 $\mu A$ . Converter operation requires this minimum load to create a small inductor ripple current and maintain proper regulation when no load is present.

A feed-forward capacitor is placed in parallel with  $R_{FBT}$  to improve load step transient response. Its value is usually determined experimentally by load stepping between DCM and CCM conduction modes and adjusting for best transient response and minimum output ripple.

A table of values for  $R_{FBT}$ ,  $R_{FBB}$ ,  $C_{FF}$  and  $R_{ON}$  is included in the applications schematic.

### SOFT-START CAPACITOR SELECTION

Programmable soft-start permits the regulator to slowly ramp to its steady state operating point after being enabled, thereby reducing current inrush from the input supply and slowing the output voltage rise-time to prevent overshoot.

Upon turn-on, after all UVLO conditions have been passed, an internal 8 $\mu A$  current source begins charging the external soft-start capacitor. The soft-start time duration to reach steady state operation is given by the formula:

$$t_{SS} = V_{REF} * C_{SS} / I_{SS} = 0.8V * C_{SS} / 8\mu A \quad (4)$$

This equation can be rearranged as follows:

$$C_{SS} = t_{SS} * 8 \mu A / 0.8V \quad (5)$$

Use of a 0.022 $\mu F$  capacitor results in 2.2 msec soft-start duration. This is recommended as a minimum value.

As the soft-start input exceeds 0.8V the output of the power stage will be in regulation. The soft-start capacitor continues charging until it reaches approximately 3.8V on the SS pin. Voltage levels between 0.8V and 3.8V have no effect on other circuit operation. Note that the following conditions will reset the soft-start capacitor by discharging the SS input to ground with an internal 200  $\mu A$  current sink.

- The enable input being “pulled low”
- Thermal shutdown condition
- Over-current fault
- Internal  $V_{CC}$  UVLO (Approx 4V input to  $V_{IN}$ )

### $C_O$ SELECTION

None of the required  $C_O$  output capacitance is contained within the module. At a minimum, the output capacitor must meet the worst case minimum ripple current rating of  $0.5 * I_{LR P-P}$ , as calculated in [Equation 17](#) below. Beyond that, additional capacitance will reduce output ripple so long as the ESR is low enough to permit it. A minimum value of 10  $\mu F$  is generally required. Experimentation will be required if attempting to operate with a minimum value. Ceramic capacitors or other low ESR types are recommended. See AN-2024 for more detail.

The following equation provides a good first pass approximation of  $C_O$  for load transient requirements:

$$C_O \geq I_{STEP} * V_{FB} * L * V_{IN} / (4 * V_O * (V_{IN} - V_O) * V_{OUT-TRAN}) \quad (6)$$

Solving:

$$C_O \geq 3A * 0.8V * 6.8\mu H * 24V / (4 * 3.3V * (24V - 3.3V) * 33mV) \geq 43\mu F \quad (7)$$

The LMZ14203 demonstration and evaluation boards are populated with a 100  $\mu F$  6.3V X5R output capacitor. Locations for extra output capacitors are provided.

### $C_{IN}$ SELECTION

The LMZ14203 module contains an internal 0.47  $\mu F$  input ceramic capacitor. Additional input capacitance is required external to the module to handle the input ripple current of the application. This input capacitance should be located in very close proximity to the module. Input capacitor selection is generally directed to satisfy the input ripple current requirements rather than by capacitance value. Worst case input ripple current rating is dictated by the equation:

$$I(C_{IN(RMS)}) \cong 1/2 * I_O * \sqrt{D / (1-D)} \quad (8)$$

where  $D \cong V_O / V_{IN}$

(As a point of reference, the worst case ripple current will occur when the module is presented with full load current and when  $V_{IN} = 2 * V_O$ ).

Recommended minimum input capacitance is 10µF X7R ceramic with a voltage rating at least 25% higher than the maximum applied input voltage for the application. It is also recommended that attention be paid to the voltage and temperature deratings of the capacitor selected. It should be noted that ripple current rating of ceramic capacitors may be missing from the capacitor data sheet and you may have to contact the capacitor manufacturer for this rating.

If the system design requires a certain minimum value of input ripple voltage  $\Delta V_{IN}$  be maintained then the following equation may be used.

$$C_{IN} \geq I_O * D * (1-D) / f_{SW-CCM} * \Delta V_{IN} \quad (9)$$

If  $\Delta V_{IN}$  is 1% of  $V_{IN}$  for a 24V input to 3.3V output application this equals 240 mV and  $f_{SW} = 400$  kHz.

$$C_{IN} \geq 3A * 3.3V/24V * (1 - 3.3V/24V) / (400000 * 0.240 V) \\ \geq 3.7\mu F$$

Additional bulk capacitance with higher ESR may be required to damp any resonant effects of the input capacitance and parasitic inductance of the incoming supply lines.

### **R<sub>ON</sub> RESISTOR SELECTION**

Many designs will begin with a desired switching frequency in mind. For that purpose the following equation can be used.

$$f_{SW(CCM)} \cong V_O / (1.3 * 10^{-10} * R_{ON}) \quad (10)$$

This can be rearranged as

$$R_{ON} \cong V_O / (1.3 * 10^{-10} * f_{SW(CCM)}) \quad (11)$$

The selection of  $R_{ON}$  and  $f_{SW(CCM)}$  must be confined by limitations in the on-time and off-time for the [COT Control Circuit Overview](#) section.

The on-time of the LMZ14203 timer is determined by the resistor  $R_{ON}$  and the input voltage  $V_{IN}$ . It is calculated as follows:

$$t_{ON} = (1.3 * 10^{-10} * R_{ON}) / V_{IN} \quad (12)$$

The inverse relationship of  $t_{ON}$  and  $V_{IN}$  gives a nearly constant switching frequency as  $V_{IN}$  is varied.  $R_{ON}$  should be selected such that the on-time at maximum  $V_{IN}$  is greater than 150 ns. The on-timer has a limiter to ensure a minimum of 150 ns for  $t_{ON}$ . This limits the maximum operating frequency, which is governed by the following equation:

$$f_{SW(MAX)} = V_O / (V_{IN(MAX)} * 150 \text{ nsec}) \quad (13)$$

This equation can be used to select  $R_{ON}$  if a certain operating frequency is desired so long as the minimum on-time of 150 ns is observed. The limit for  $R_{ON}$  can be calculated as follows:

$$R_{ON} \geq V_{IN(MAX)} * 150 \text{ nsec} / (1.3 * 10^{-10}) \quad (14)$$

If  $R_{ON}$  calculated in [Equation 11](#) is less than the minimum value determined in [Equation 14](#) a lower frequency should be selected. Alternatively,  $V_{IN(MAX)}$  can also be limited in order to keep the frequency unchanged.

Additionally note, the minimum off-time of 260 ns limits the maximum duty ratio. Larger  $R_{ON}$  (lower  $F_{SW}$ ) should be selected in any application requiring large duty ratio.

### **Discontinuous Conduction and Continuous Conduction Modes**

At light load the regulator will operate in discontinuous conduction mode (DCM). With load currents above the critical conduction point, it will operate in continuous conduction mode (CCM). When operating in DCM the switching cycle begins at zero amps inductor current; increases up to a peak value, and then recedes back to zero before the end of the off-time. Note that during the period of time that inductor current is zero, all load current is supplied by the output capacitor. The next on-time period starts when the voltage on the at the FB pin falls below the internal reference. The switching frequency is lower in DCM and varies more with load current as compared to CCM. Conversion efficiency in DCM is maintained since conduction and switching losses are reduced with the smaller load and lower switching frequency. Operating frequency in DCM can be calculated as follows:

$$f_{SW(DCM)} \cong V_O * (V_{IN} - 1) * 6.8\mu H * 1.18 * 10^{20} * I_O / (V_{IN} - V_O) * R_{ON}^2 \quad (15)$$

In CCM, current flows through the inductor through the entire switching cycle and never falls to zero during the off-time. The switching frequency remains relatively constant with load current and line voltage variations. The CCM operating frequency can be calculated using [Equation 7](#) above.

Following is a comparison pair of waveforms of the showing both CCM (upper) and DCM operating modes.

**Figure 25. CCM and DCM Operating Modes**

$$V_{IN} = 24V, \\ V_O = 3.3V, I_O = 3A/0.4A \quad 2 \mu\text{sec/div}$$

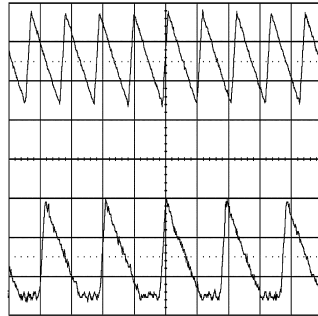

The approximate formula for determining the DCM/CCM boundary is as follows:

$$I_{DCB} \approx V_O \cdot (V_{IN} - V_O) / (2 \cdot 6.8 \mu\text{H} \cdot f_{SW(CCM)} \cdot V_{IN}) \quad (16)$$

Following is a typical waveform showing the boundary condition.

**Figure 26. Transition Mode Operation**

$$V_{IN} = 24V, V_O = 3.3V, I_O = 0.5 A \quad 2 \mu\text{sec/div}$$

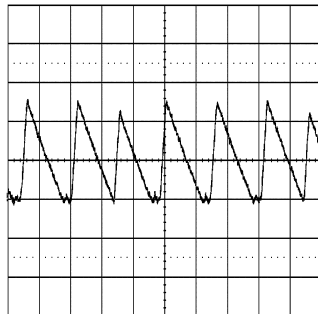

The inductor internal to the module is 6.8  $\mu\text{H}$ . This value was chosen as a good balance between low and high input voltage applications. The main parameter affected by the inductor is the amplitude of the inductor ripple current ( $I_{LR}$ ).  $I_{LR}$  can be calculated with:

$$I_{LR P-P} = V_O \cdot (V_{IN} - V_O) / (6.8 \mu\text{H} \cdot f_{SW} \cdot V_{IN}) \quad (17)$$

Where  $V_{IN}$  is the maximum input voltage and  $f_{SW}$  is determined from [Equation 10](#).

If the output current  $I_O$  is determined by assuming that  $I_O = I_L$ , the higher and lower peak of  $I_{LR}$  can be determined. Be aware that the lower peak of  $I_{LR}$  must be positive if CCM operation is required.

## POWER DISSIPATION AND BOARD THERMAL REQUIREMENTS

For the design case of  $V_{IN} = 24V$ ,  $V_O = 3.3V$ ,  $I_O = 3A$ ,  $T_{AMB(MAX)} = 85^\circ\text{C}$ , and  $T_{JUNCTION} = 125^\circ\text{C}$ , the device must see a thermal resistance from case to ambient of:

$$\theta_{CA} < (T_{J-MAX} - T_{AMB(MAX)}) / P_{IC-LOSS} - \theta_{JC} \quad (18)$$

Given the typical thermal resistance from junction to case to be 1.9  $^\circ\text{C/W}$ . Use the 85 $^\circ\text{C}$  power dissipation curves in the [Typical Performance Characteristics](#) section to estimate the  $P_{IC-LOSS}$  for the application being designed. In this application it is 2.25W.

$$\theta_{CA} < (125 - 85) / 2.25W - 1.9 = 15.8$$

To reach  $\theta_{CA} = 15.8$ , the PCB is required to dissipate heat effectively. With no airflow and no external heat, a good estimate of the required board area covered by 1 oz. copper on both the top and bottom metal layers is:

$$\text{Board Area}_{\text{cm}^2} > 500^{\circ}\text{C} \times \text{cm}^2/\text{W} / \theta_{CA} \quad (19)$$

As a result, approximately 31.5 square cm of 1 oz copper on top and bottom layers is required for the PCB design. The PCB copper heat sink must be connected to the exposed pad. Approximately thirty six, 8mils thermal vias spaced 59mils (1.5 mm) apart must connect the top copper to the bottom copper. For an example of a high thermal performance PCB layout, refer to the Evaluation Board application note AN-2024 [SNVA422](#).

## PC BOARD LAYOUT GUIDELINES

PC board layout is an important part of DC-DC converter design. Poor board layout can disrupt the performance of a DC-DC converter and surrounding circuitry by contributing to EMI, ground bounce and resistive voltage drop in the traces. These can send erroneous signals to the DC-DC converter resulting in poor regulation or instability. Good layout can be implemented by following a few simple design rules.

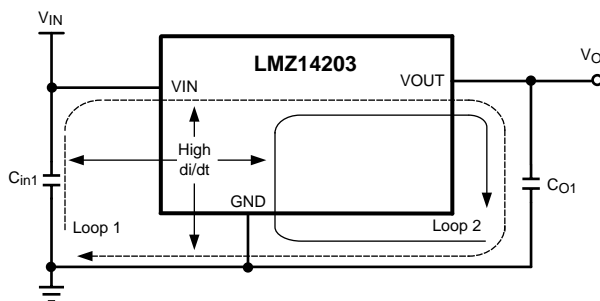

### 1. Minimize area of switched current loops.

From an EMI reduction standpoint, it is imperative to minimize the high  $di/dt$  paths during PC board layout. The high current loops that do not overlap have high  $di/dt$  content that will cause observable high frequency noise on the output pin if the input capacitor ( $C_{in1}$ ) is placed at a distance away from the LMZ14203. Therefore place  $C_{in1}$  as close as possible to the LMZ14203 VIN and GND exposed pad. This will minimize the high  $di/dt$  area and reduce radiated EMI. Additionally, grounding for both the input and output capacitor should consist of a localized top side plane that connects to the GND exposed pad (EP).

### 2. Have a single point ground.

The ground connections for the feedback, soft-start, and enable components should be routed to the GND pin of the device. This prevents any switched or load currents from flowing in the analog ground traces. If not properly handled, poor grounding can result in degraded load regulation or erratic output voltage ripple behavior. Provide the single point ground connection from pin 4 to EP.

### 3. Minimize trace length to the FB pin.

Both feedback resistors,  $R_{FBT}$  and  $R_{FBB}$ , and the feed forward capacitor  $C_{FF}$ , should be located close to the FB pin. Since the FB node is high impedance, maintain the copper area as small as possible. The trace area from  $R_{FBT}$ ,  $R_{FBB}$ , and  $C_{FF}$  should be routed away from the body of the LMZ14203 to minimize noise.

### 4. Make input and output bus connections as wide as possible.

This reduces any voltage drops on the input or output of the converter and maximizes efficiency. To optimize voltage accuracy at the load, ensure that a separate feedback voltage sense trace is made to the load. Doing so will correct for voltage drops and provide optimum output accuracy.

### 5. Provide adequate device heat-sinking.

Use an array of heat-sinking vias to connect the exposed pad to the ground plane on the bottom PCB layer. If the PCB has a plurality of copper layers, these thermal vias can also be employed to make connection to inner layer heat-spreading ground planes. For best results use a 6 x 6 via array with minimum via diameter of 8mils thermal vias spaced 59mils (1.5 mm). Ensure enough copper area is used for heat-sinking to keep the junction temperature below 125°C.



## Additional Features

### OUTPUT OVER-VOLTAGE COMPARATOR

The voltage at FB is compared to a 0.92V internal reference. If FB rises above 0.92V the on-time is immediately terminated. This condition is known as over-voltage protection (OVP). It can occur if the input voltage is increased very suddenly or if the output load is decreased very suddenly. Once OVP is activated, the top MOSFET on-times will be inhibited until the condition clears. Additionally, the synchronous MOSFET will remain on until inductor current falls to zero.

### CURRENT LIMIT

Current limit detection is carried out during the off-time by monitoring the current in the synchronous MOSFET. Referring to the Functional Block Diagram, when the top MOSFET is turned off, the inductor current flows through the load, the PGND pin and the internal synchronous MOSFET. If this current exceeds 4.2A (typical) the current limit comparator disables the start of the next on-time period. The next switching cycle will occur only if the FB input is less than 0.8V and the inductor current has decreased below 4.2A. Inductor current is monitored during the period of time the synchronous MOSFET is conducting. So long as inductor current exceeds 4.2A, further on-time intervals for the top MOSFET will not occur. Switching frequency is lower during current limit due to the longer off-time. It should also be noted that current limit is dependent on both duty cycle and temperature.

### THERMAL PROTECTION

The junction temperature of the LMZ14203 should not be allowed to exceed its maximum ratings. Thermal protection is implemented by an internal Thermal Shutdown circuit which activates at 165 °C (typ) causing the device to enter a low power standby state. In this state the main MOSFET remains off causing  $V_O$  to fall, and additionally the CSS capacitor is discharged to ground. Thermal protection helps prevent catastrophic failures for accidental device overheating. When the junction temperature falls back below 145 °C (typ Hyst = 20 °C) the SS pin is released,  $V_O$  rises smoothly, and normal operation resumes.

Applications requiring maximum output current especially those at high input voltage may require application derating at elevated temperatures.

### ZERO COIL CURRENT DETECTION

The current of the lower (synchronous) MOSFET is monitored by a zero coil current detection circuit which inhibits the synchronous MOSFET when its current reaches zero until the next on-time. This circuit enables the DCM operating mode, which improves efficiency at light loads.

### PRE-BIASED STARTUP

The LMZ14203 will properly start up into a pre-biased output. This startup situation is common in multiple rail logic applications where current paths may exist between different power rails during the startup sequence. The following scope capture shows proper behavior during this event.

**Figure 27. Pre-Biased Startup**

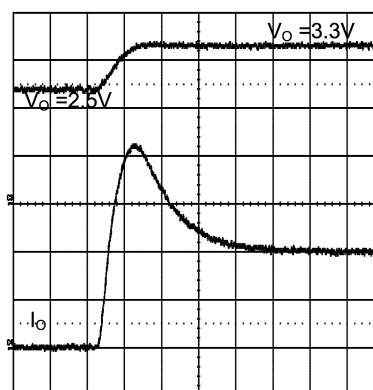

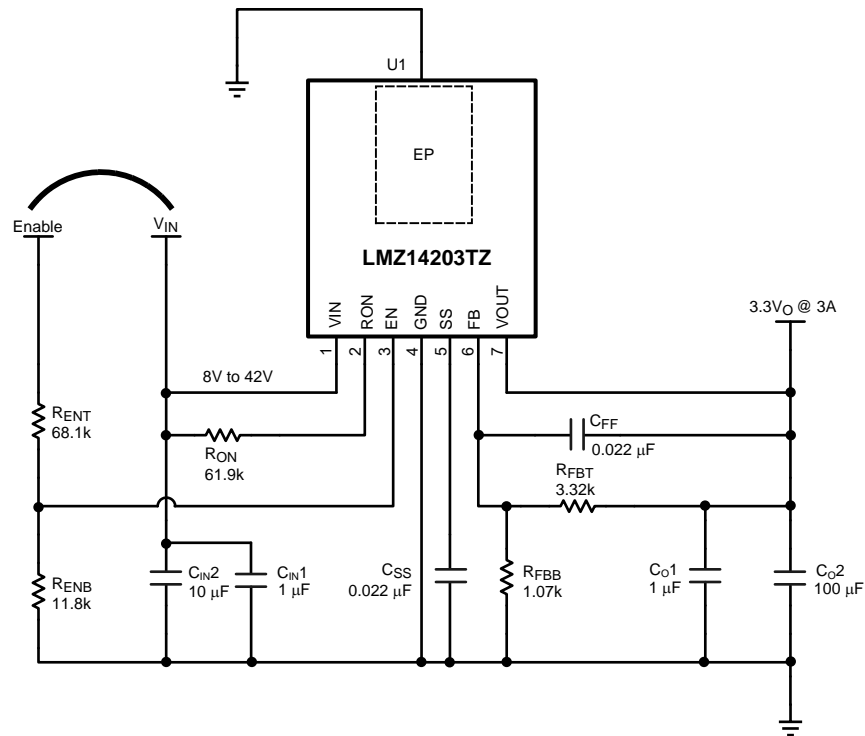

**Evaluation Board Schematic Diagram**

Ref Des	Description	Case Size	Manufacturer	Manufacturer P/N
U1	SIMPLE SWITCHER ®	PFM-7	Texas Instruments	LMZ14203TZ
C <sub>in1</sub>	1 µF, 50V, X7R	1206	Taiyo Yuden	UMK316B7105KL-T
C <sub>in2</sub>	10 µF, 50V, X7R	1210	Taiyo Yuden	UMK325BJ106MM-T
C <sub>O1</sub>	1 µF, 50V, X7R	1206	Taiyo Yuden	UMK316B7105KL-T
C <sub>O2</sub>	100 µF, 6.3V, X7R	1210	Taiyo Yuden	JMK325BJ107MM-T
R <sub>FBT</sub>	3.32 kΩ	0603	Vishay Dale	CRCW06033K32FKEA
R <sub>FBB</sub>	1.07 kΩ	0603	Vishay Dale	CRCW06031K07FKEA
R <sub>ON</sub>	61.9 kΩ	0603	Vishay Dale	CRCW060361K9FKEA
R <sub>ENT</sub>	68.1 kΩ	0603	Vishay Dale	CRCW060368K1FKEA
R <sub>ENB</sub>	11.8 kΩ	0603	Vishay Dale	CRCW060311K8FKEA
C <sub>FF</sub>	22 nF, ±10%, X7R, 16V	0603	TDK	C1608X7R1H223K
C <sub>SS</sub>	22 nF, ±10%, X7R, 16V	0603	TDK	C1608X7R1H223K

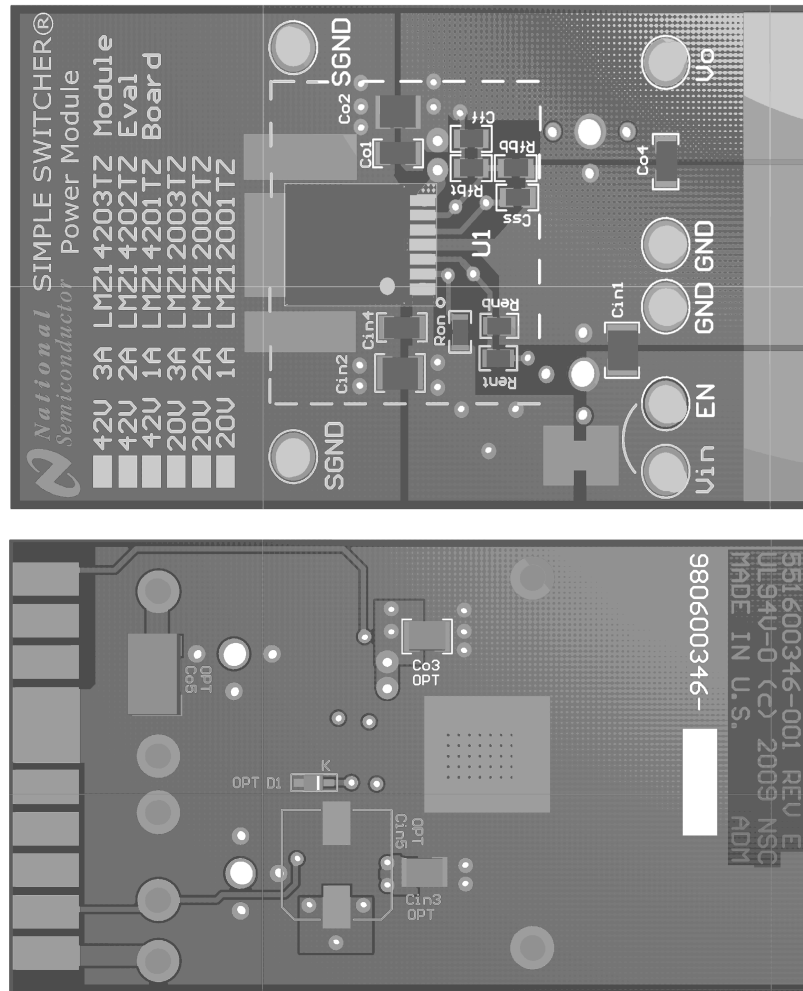

**Figure 28. Board Layout – Top and Bottom View**

### Power Module SMT Guidelines

The recommendations below are for a standard module surface mount assembly

- Land Pattern – Follow the PCB land pattern with either soldermask defined or non-soldermask defined pads
- Stencil Aperture
  - For the exposed die attach pad (DAP), adjust the stencil for approximately 80% coverage of the PCB land pattern
  - For all other I/O pads use a 1:1 ratio between the aperture and the land pattern recommendation
- Solder Paste – Use a standard SAC Alloy such as SAC 305, type 3 or higher
- Stencil Thickness – 0.125 to 0.15mm
- Reflow - Refer to solder paste supplier recommendation and optimized per board size and density
- Maximum number of reflows allowed is one

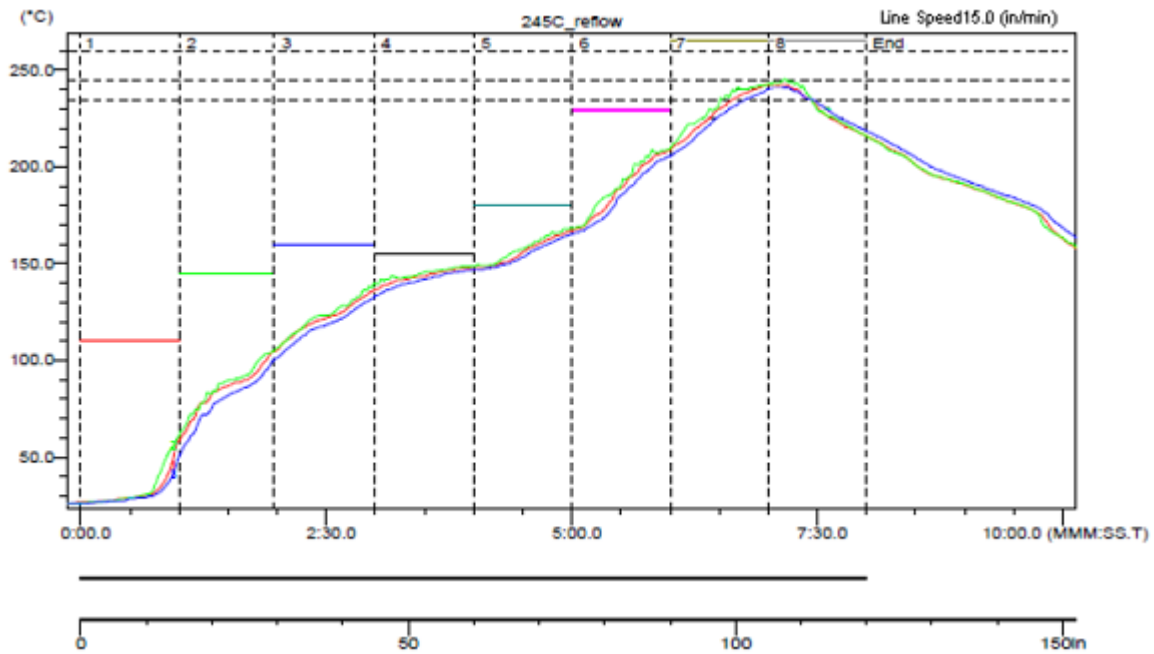

Figure 29. Sample Reflow Profile

Table 1.

Probe	Max Temp (°C)	Reached Max Temp	Time Above 235°C	Reached 235°C	Time Above 245°C	Reached 245°C	Time Above 260°C	Reached 260°C
#1	242.5	6.58	0.49	6.39	0.00	–	0.00	–
#2	242.5	7.10	0.55	6.31	0.00	7.10	0.00	–
#3	241.0	7.09	0.42	6.44	0.00	–	0.00	–

### REVISION HISTORY

Changes from Revision N (March 2013) to Revision O	Page
• Added Peak Reflow Case Temp = 245°C .....	1
• Deleted 12mil .....	5
• Changed 12mils .....	15
• Changed 12mils .....	15
• Added Power Module SMT Guidelines .....	18

**PACKAGING INFORMATION**

Orderable Device	Status (1)	Package Type	Package Drawing	Pins	Package Qty	Eco Plan (2)	Lead/Ball Finish	MSL Peak Temp (3)	Op Temp (°C)	Device Marking (4/5)	Samples
LMZ14203TZ-ADJ/NOPB	ACTIVE	TO-PMOD	NDW	7	250	Green (RoHS & no Sb/Br)	CU SN	Level-3-245C-168 HR	-40 to 125	LMZ14203 TZ-ADJ	<a href="#">Samples</a>
LMZ14203TZE-ADJ/NOPB	ACTIVE	TO-PMOD	NDW	7	45	Green (RoHS & no Sb/Br)	CU SN	Level-3-245C-168 HR	-40 to 125	LMZ14203 TZ-ADJ	<a href="#">Samples</a>
LMZ14203TZX-ADJ/NOPB	ACTIVE	TO-PMOD	NDW	7	500	Green (RoHS & no Sb/Br)	CU SN	Level-3-245C-168 HR	-40 to 125	LMZ14203 TZ-ADJ	<a href="#">Samples</a>

(1) The marketing status values are defined as follows:

**ACTIVE:** Product device recommended for new designs.

**LIFEBUY:** TI has announced that the device will be discontinued, and a lifetime-buy period is in effect.

**NRND:** Not recommended for new designs. Device is in production to support existing customers, but TI does not recommend using this part in a new design.

**PREVIEW:** Device has been announced but is not in production. Samples may or may not be available.

**OBSELETE:** TI has discontinued the production of the device.

(2) Eco Plan - The planned eco-friendly classification: Pb-Free (RoHS), Pb-Free (RoHS Exempt), or Green (RoHS & no Sb/Br) - please check <http://www.ti.com/productcontent> for the latest availability information and additional product content details.

**TBD:** The Pb-Free/Green conversion plan has not been defined.

**Pb-Free (RoHS):** TI's terms "Lead-Free" or "Pb-Free" mean semiconductor products that are compatible with the current RoHS requirements for all 6 substances, including the requirement that lead not exceed 0.1% by weight in homogeneous materials. Where designed to be soldered at high temperatures, TI Pb-Free products are suitable for use in specified lead-free processes.

**Pb-Free (RoHS Exempt):** This component has a RoHS exemption for either 1) lead-based flip-chip solder bumps used between the die and package, or 2) lead-based die adhesive used between the die and leadframe. The component is otherwise considered Pb-Free (RoHS compatible) as defined above.

**Green (RoHS & no Sb/Br):** TI defines "Green" to mean Pb-Free (RoHS compatible), and free of Bromine (Br) and Antimony (Sb) based flame retardants (Br or Sb do not exceed 0.1% by weight in homogeneous material)

(3) MSL, Peak Temp. -- The Moisture Sensitivity Level rating according to the JEDEC industry standard classifications, and peak solder temperature.

(4) There may be additional marking, which relates to the logo, the lot trace code information, or the environmental category on the device.

(5) Multiple Device Markings will be inside parentheses. Only one Device Marking contained in parentheses and separated by a "~" will appear on a device. If a line is indented then it is a continuation of the previous line and the two combined represent the entire Device Marking for that device.

**Important Information and Disclaimer:** The information provided on this page represents TI's knowledge and belief as of the date that it is provided. TI bases its knowledge and belief on information provided by third parties, and makes no representation or warranty as to the accuracy of such information. Efforts are underway to better integrate information from third parties. TI has taken and continues to take reasonable steps to provide representative and accurate information but may not have conducted destructive testing or chemical analysis on incoming materials and chemicals. TI and TI suppliers consider certain information to be proprietary, and thus CAS numbers and other limited information may not be available for release.

In no event shall TI's liability arising out of such information exceed the total purchase price of the TI part(s) at issue in this document sold by TI to Customer on an annual basis.

## TAPE AND REEL INFORMATION



### QUADRANT ASSIGNMENTS FOR PIN 1 ORIENTATION IN TAPE



\*All dimensions are nominal

Device	Package Type	Package Drawing	Pins	SPQ	Reel Diameter (mm)	Reel Width W1 (mm)	A0 (mm)	B0 (mm)	K0 (mm)	P1 (mm)	W (mm)	Pin1 Quadrant
LMZ14203TZ-ADJ/NOPB	TO-PMOD	NDW	7	250	330.0	24.4	10.6	14.22	5.0	16.0	24.0	Q2
LMZ14203TZ-ADJ/NOPB	TO-PMOD	NDW	7	500	330.0	24.4	10.6	14.22	5.0	16.0	24.0	Q2

**TAPE AND REEL BOX DIMENSIONS**



\*All dimensions are nominal

Device	Package Type	Package Drawing	Pins	SPQ	Length (mm)	Width (mm)	Height (mm)
LMZ14203TZ-ADJ/NOPB	TO-PMOD	NDW	7	250	367.0	367.0	45.0
LMZ14203TZ-ADJ/NOPB	TO-PMOD	NDW	7	500	367.0	367.0	45.0



NDW0007A

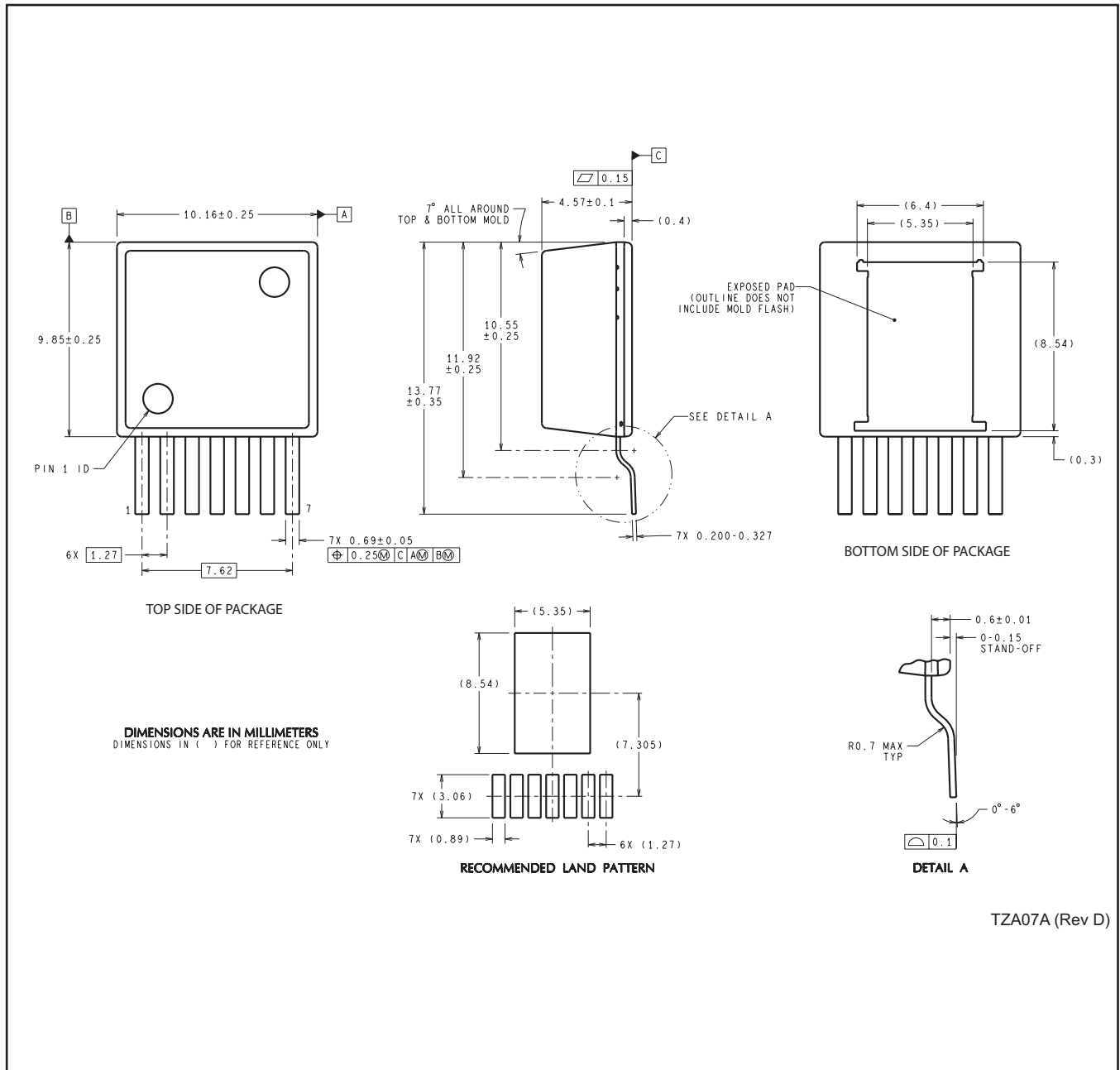

TZA07A (Rev D)

## IMPORTANT NOTICE

Texas Instruments Incorporated and its subsidiaries (TI) reserve the right to make corrections, enhancements, improvements and other changes to its semiconductor products and services per JESD46, latest issue, and to discontinue any product or service per JESD48, latest issue. Buyers should obtain the latest relevant information before placing orders and should verify that such information is current and complete. All semiconductor products (also referred to herein as "components") are sold subject to TI's terms and conditions of sale supplied at the time of order acknowledgment.

TI warrants performance of its components to the specifications applicable at the time of sale, in accordance with the warranty in TI's terms and conditions of sale of semiconductor products. Testing and other quality control techniques are used to the extent TI deems necessary to support this warranty. Except where mandated by applicable law, testing of all parameters of each component is not necessarily performed.

TI assumes no liability for applications assistance or the design of Buyers' products. Buyers are responsible for their products and applications using TI components. To minimize the risks associated with Buyers' products and applications, Buyers should provide adequate design and operating safeguards.

TI does not warrant or represent that any license, either express or implied, is granted under any patent right, copyright, mask work right, or other intellectual property right relating to any combination, machine, or process in which TI components or services are used. Information published by TI regarding third-party products or services does not constitute a license to use such products or services or a warranty or endorsement thereof. Use of such information may require a license from a third party under the patents or other intellectual property of the third party, or a license from TI under the patents or other intellectual property of TI.

Reproduction of significant portions of TI information in TI data books or data sheets is permissible only if reproduction is without alteration and is accompanied by all associated warranties, conditions, limitations, and notices. TI is not responsible or liable for such altered documentation. Information of third parties may be subject to additional restrictions.

Resale of TI components or services with statements different from or beyond the parameters stated by TI for that component or service voids all express and any implied warranties for the associated TI component or service and is an unfair and deceptive business practice. TI is not responsible or liable for any such statements.

Buyer acknowledges and agrees that it is solely responsible for compliance with all legal, regulatory and safety-related requirements concerning its products, and any use of TI components in its applications, notwithstanding any applications-related information or support that may be provided by TI. Buyer represents and agrees that it has all the necessary expertise to create and implement safeguards which anticipate dangerous consequences of failures, monitor failures and their consequences, lessen the likelihood of failures that might cause harm and take appropriate remedial actions. Buyer will fully indemnify TI and its representatives against any damages arising out of the use of any TI components in safety-critical applications.

In some cases, TI components may be promoted specifically to facilitate safety-related applications. With such components, TI's goal is to help enable customers to design and create their own end-product solutions that meet applicable functional safety standards and requirements. Nonetheless, such components are subject to these terms.

No TI components are authorized for use in FDA Class III (or similar life-critical medical equipment) unless authorized officers of the parties have executed a special agreement specifically governing such use.

Only those TI components which TI has specifically designated as military grade or "enhanced plastic" are designed and intended for use in military/aerospace applications or environments. Buyer acknowledges and agrees that any military or aerospace use of TI components which have **not** been so designated is solely at the Buyer's risk, and that Buyer is solely responsible for compliance with all legal and regulatory requirements in connection with such use.

TI has specifically designated certain components as meeting ISO/TS16949 requirements, mainly for automotive use. In any case of use of non-designated products, TI will not be responsible for any failure to meet ISO/TS16949.

### Products

Audio	<a href="http://www.ti.com/audio">www.ti.com/audio</a>
Amplifiers	<a href="http://amplifier.ti.com">amplifier.ti.com</a>
Data Converters	<a href="http://dataconverter.ti.com">dataconverter.ti.com</a>
DLP® Products	<a href="http://www.dlp.com">www.dlp.com</a>
DSP	<a href="http://dsp.ti.com">dsp.ti.com</a>
Clocks and Timers	<a href="http://www.ti.com/clocks">www.ti.com/clocks</a>
Interface	<a href="http://interface.ti.com">interface.ti.com</a>
Logic	<a href="http://logic.ti.com">logic.ti.com</a>
Power Mgmt	<a href="http://power.ti.com">power.ti.com</a>
Microcontrollers	<a href="http://microcontroller.ti.com">microcontroller.ti.com</a>
RFID	<a href="http://www.ti-rfid.com">www.ti-rfid.com</a>
OMAP Applications Processors	<a href="http://www.ti.com/omap">www.ti.com/omap</a>
Wireless Connectivity	<a href="http://www.ti.com/wirelessconnectivity">www.ti.com/wirelessconnectivity</a>

### Applications

Automotive and Transportation	<a href="http://www.ti.com/automotive">www.ti.com/automotive</a>
Communications and Telecom	<a href="http://www.ti.com/communications">www.ti.com/communications</a>
Computers and Peripherals	<a href="http://www.ti.com/computers">www.ti.com/computers</a>
Consumer Electronics	<a href="http://www.ti.com/consumer-apps">www.ti.com/consumer-apps</a>
Energy and Lighting	<a href="http://www.ti.com/energy">www.ti.com/energy</a>
Industrial	<a href="http://www.ti.com/industrial">www.ti.com/industrial</a>
Medical	<a href="http://www.ti.com/medical">www.ti.com/medical</a>
Security	<a href="http://www.ti.com/security">www.ti.com/security</a>
Space, Avionics and Defense	<a href="http://www.ti.com/space-avionics-defense">www.ti.com/space-avionics-defense</a>
Video and Imaging	<a href="http://www.ti.com/video">www.ti.com/video</a>

### TI E2E Community

[e2e.ti.com](http://e2e.ti.com)

# AMEYA360

## Components Supply Platform

Authorized Distribution Brand :



Website :

Welcome to visit [www.ameya360.com](http://www.ameya360.com)

Contact Us :

➤ Address :

401 Building No.5, JiuGe Business Center, Lane 2301, Yishan Rd  
Minhang District, Shanghai , China

➤ Sales :

Direct +86 (21) 6401-6692

Email [amall@ameya360.com](mailto:amall@ameya360.com)

QQ 800077892

Skype [ameyasales1](#) [ameyasales2](#)

➤ Customer Service :

Email [service@ameya360.com](mailto:service@ameya360.com)

➤ Partnership :

Tel +86 (21) 64016692-8333

Email [mkt@ameya360.com](mailto:mkt@ameya360.com)