



2SA2153

Bipolar Transistor -50V, -2A, Low VCE(sat), PNP Single PCP

ON Semiconductor®

<http://onsemi.com>

Applications

- Voltage regulators, relay drivers, lamp drivers, electrical equipment

Features

- Adoption of MBIT process
- Low saturation voltage
- Large current capacity and wide ASO

Specifications

Absolute Maximum Ratings at Ta=25°C

Parameter	Symbol	Conditions	Ratings	Unit
Collector-to-Base Voltage	V _{CB0}		-50	V
Collector-to-Emitter Voltage	V _{CE0}		-50	V
Emitter-to-Base Voltage	V _{EB0}		-6	V
Collector Current	I _C		-2	A
Collector Current (Pulse)	I _{CP}		-4	A
Base Current	I _B		-400	mA

Continued on next page.

Package Dimensions

unit : mm (typ)

7007B-004

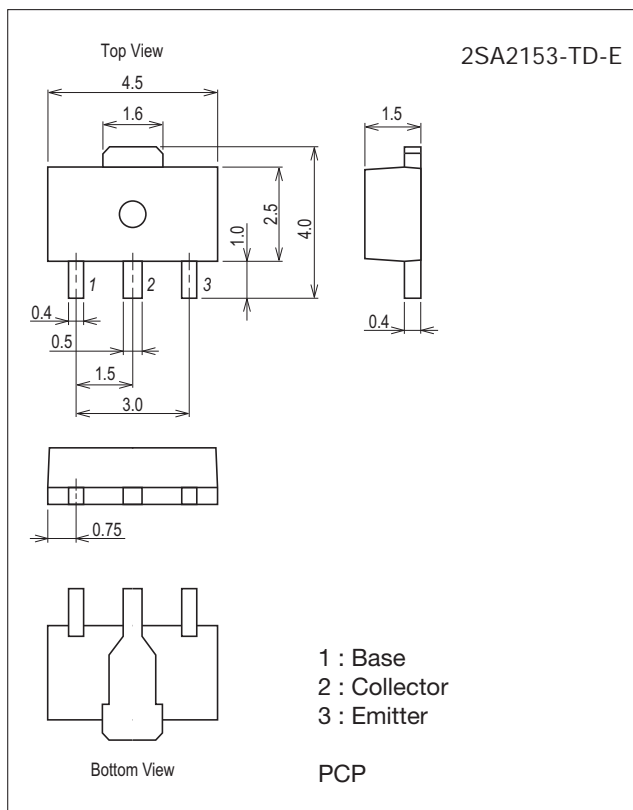

Product & Package Information

- Package : PCP
- JEITA, JEDEC : SC-62, SOT-89, TO-243
- Minimum Packing Quantity : 1,000 pcs./reel

Packing Type: TD

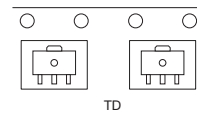

Marking

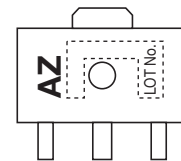

Electrical Connection

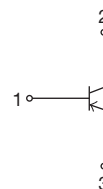

2SA2153

Continued from preceding page.

Parameter	Symbol	Conditions	Ratings	Unit
Collector Dissipation	PC	When mounted on ceramic substrate (450mm ² ×0.8mm)	1.3	W
		T _c =25°C	3.5	W
Junction Temperature	T _j		150	°C
Storage Temperature	T _{stg}		-55 to +150	°C

Stresses exceeding Maximum Ratings may damage the device. Maximum Ratings are stress ratings only. Functional operation above the Recommended Operating Conditions is not implied. Extended exposure to stresses above the Recommended Operating Conditions may affect device reliability.

Electrical Characteristics at T_a=25°C

Parameter	Symbol	Conditions	Ratings			Unit
			min	typ	max	
Collector Cutoff Current	I _{CBO}	V _{CB} =-40V, I _E =0A			-1	μA
Emitter Cutoff Current	I _{EBO}	V _{EB} =-4V, I _C =0A			-1	μA
DC Current Gain	h _{FE1}	V _{CE} =-2V, I _C =-100mA	200		560	
	h _{FE2}	V _{CE} =-2V, I _C =-1.5A	40			
Gain-Bandwidth Product	f _T	V _{CE} =-10V, I _C =-300mA		420		MHz
Output Capacitance	C _{ob}	V _{CB} =-10V, f=1MHz		16		pF
Collector-to-Emitter Saturation Voltage	V _{CE(sat)}	I _C =-1A, I _B =-50mA	-0.2		-0.4	V
Base-to-Emitter Saturation Voltage	V _{BE(sat)}	I _C =-1A, I _B =-50mA	-0.9		-1.2	V
Collector-to-Base Breakdown Voltage	V _{(BR)CBO}	I _C =-10μA, I _E =0A	-50			V
Collector-to-Emitter Breakdown Voltage	V _{(BR)CEO}	I _C =-1mA, R _{BE} =∞	-50			V
Emitter-to-Base Breakdown Voltage	V _{(BR)EBO}	I _E =-10μA, I _C =0A	-6			V
Turn-ON Time	t _{on}			35		ns
Storage Time	t _{stg}	See specified Test Circuit.		200		ns
Fall Time	t _f			24		ns

Switching Time Test Circuit

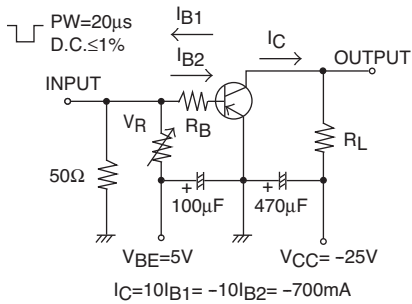

Ordering Information

Device	Package	Shipping	memo
2SA2153-TD-E	PCP	1,000pcs./reel	Pb Free

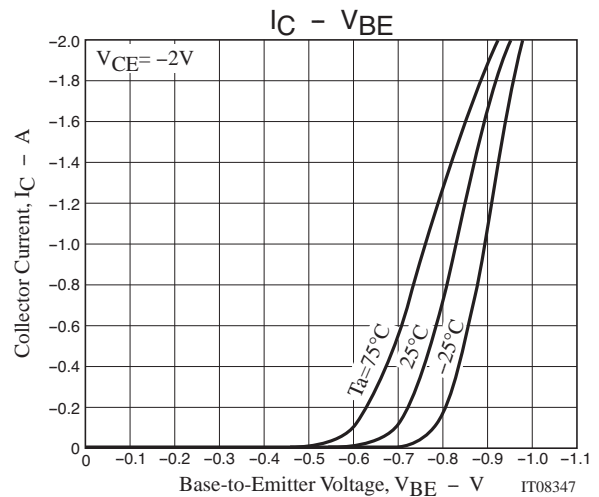
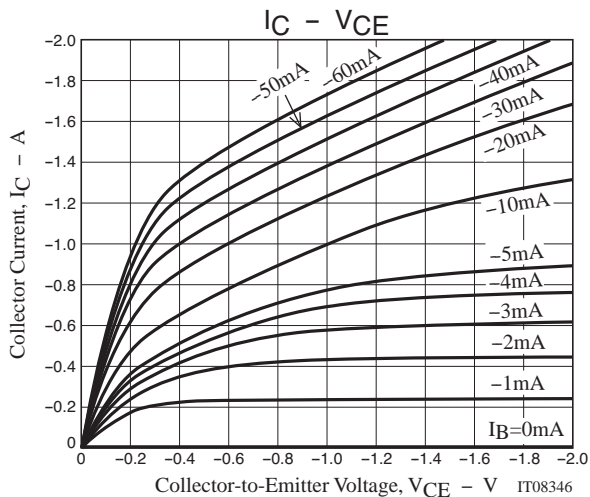

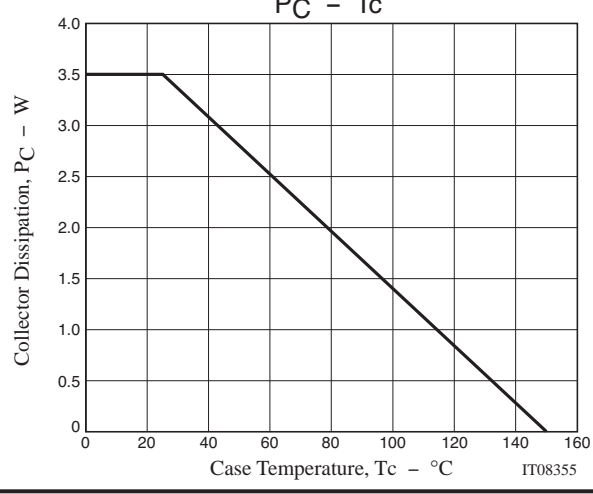
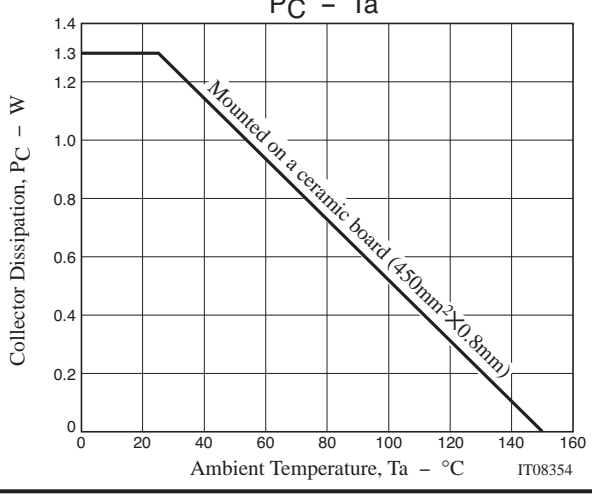
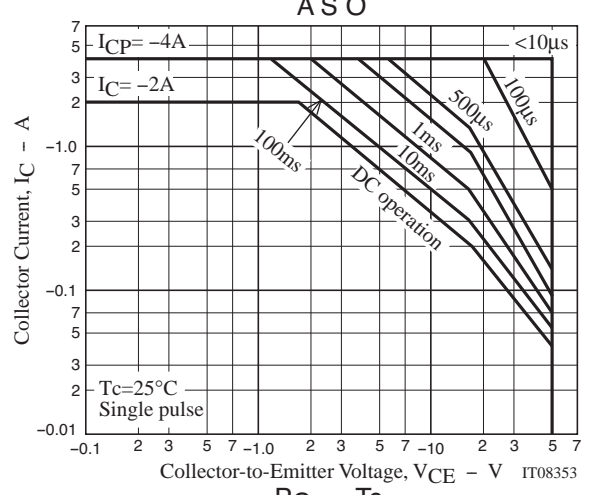
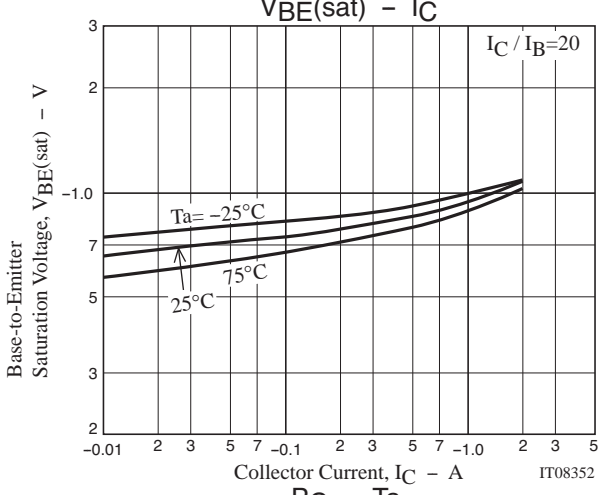
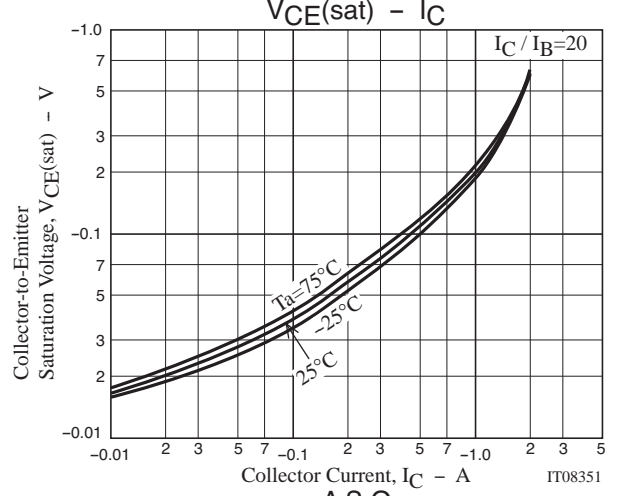
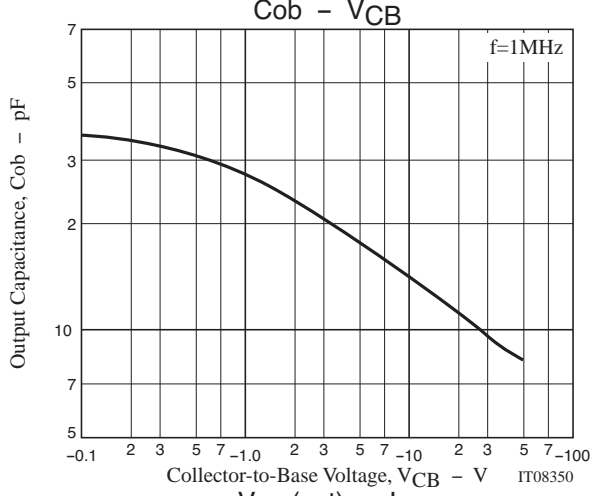
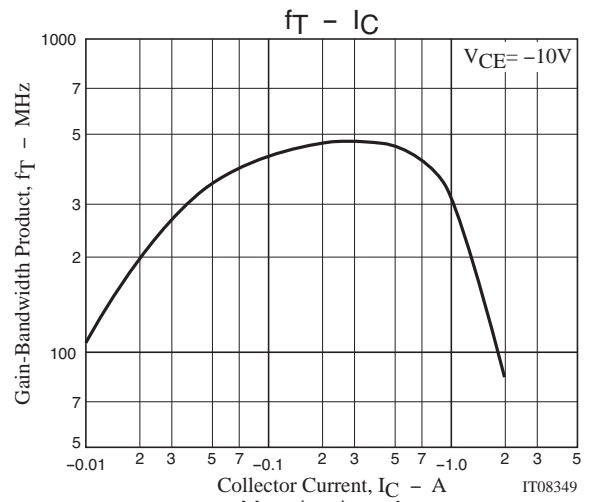
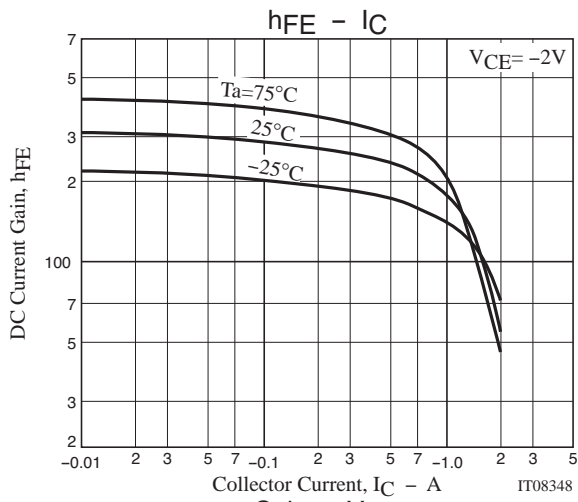

Embossed Taping Specification

2SA2153-TD-E

1. Packing Format

Package Name	Carrier Tape Type	Maximum Number of devices contained (pcs)			Packing format	
		Reel	Inner box	Outer box	Inner BOX (C-1)	Outer BOX (A-7)
PCP	PCP	1,000	4,000	24,000	4 reels contained Dimensions:mm (external) 183×72×185	6 inner boxes contained Dimensions:mm (external) 440×195×210

Reel label, Inner box label
(unit : mm)

Outer box label
It is a label at the time of factory shipments.
The form of a label may change in physical distribution process.

Packing method

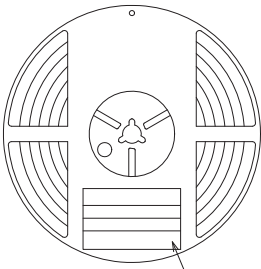

Reel label

Type No.
LOT No.
Quantity
Origin

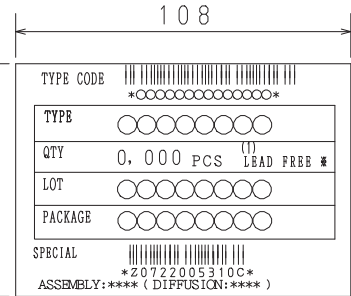
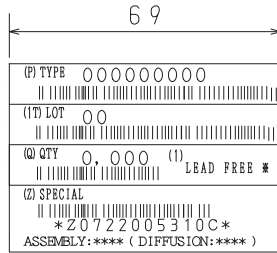

NOTE (1)

The LEAD FREE * description shows that the surface treatment of the terminal is lead free.

Label	JEITA Phase
LEAD FREE 3	JEITA Phase 3A
LEAD FREE 4	JEITA Phase 3

2. Taping configuration

2-1. Carrier tape size (unit:mm)

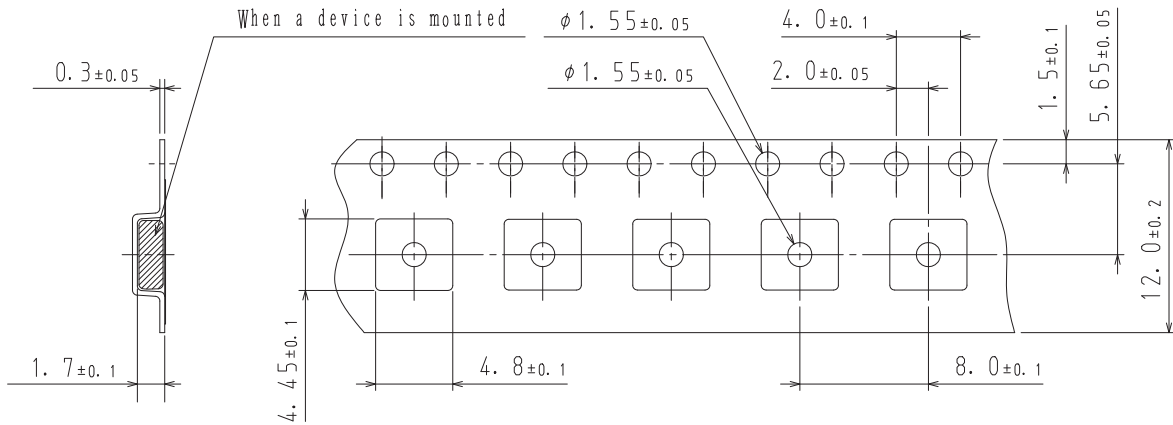

2-2. Device placement direction

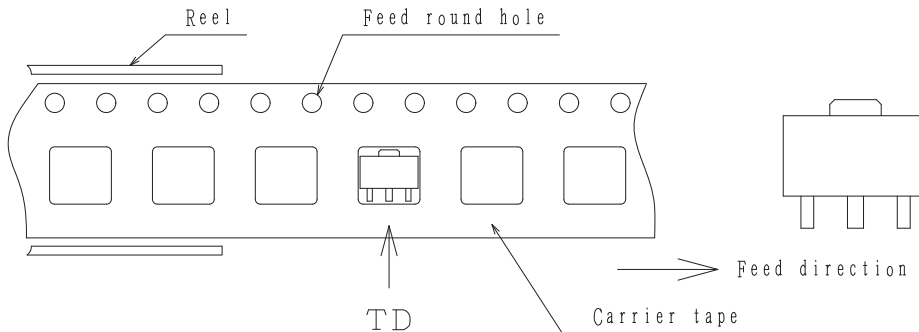

Those with pin 1 index on the feed hole side.....TD

2SA2153

Outline Drawing

2SA2153-TD-E

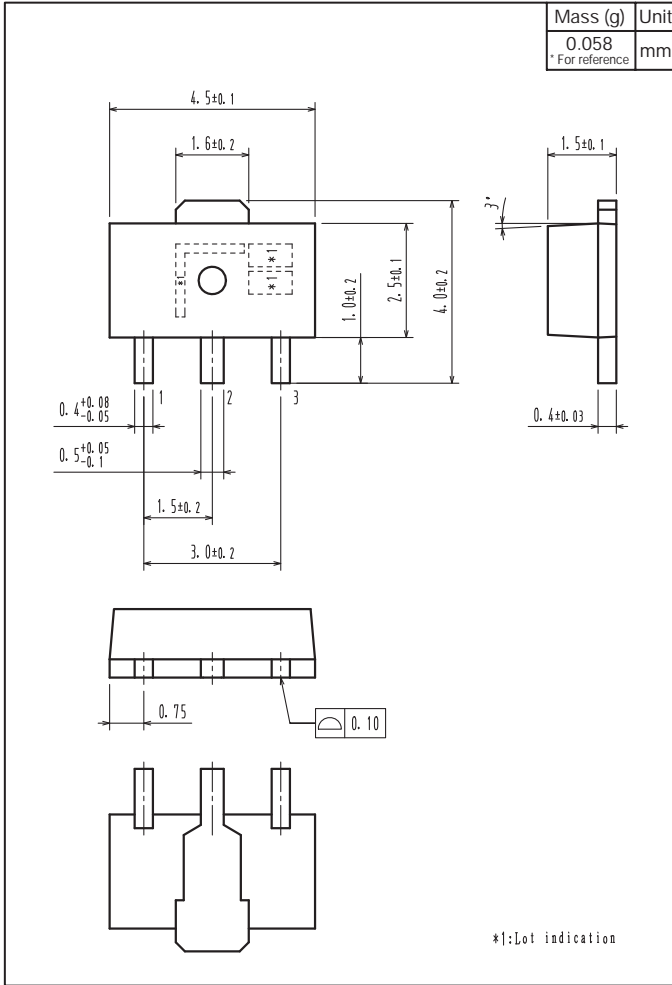

Land Pattern Example

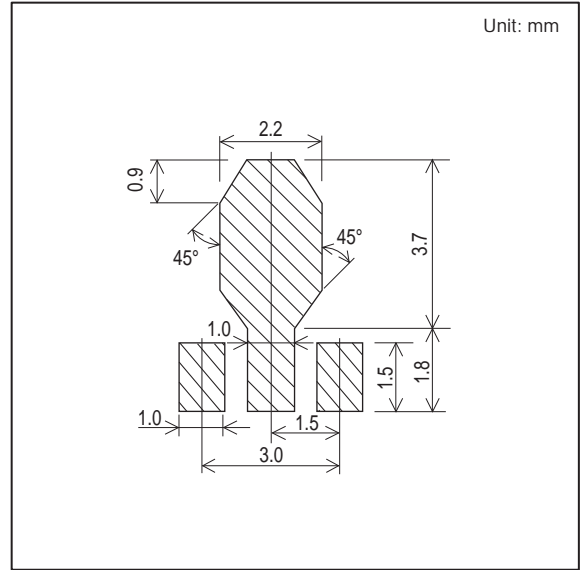

ON Semiconductor and the ON logo are registered trademarks of Semiconductor Components Industries, LLC (SCILLC). SCILLC owns the rights to a number of patents, trademarks, copyrights, trade secrets, and other intellectual property. A listing of SCILLC's product/patent coverage may be accessed at www.onsemi.com/site/pdf/Patent-Marking.pdf. SCILLC reserves the right to make changes without further notice to any products herein. SCILLC makes no warranty, representation or guarantee regarding the suitability of its products for any particular purpose, nor does SCILLC assume any liability arising out of the application or use of any product or circuit, and specifically disclaims any and all liability, including without limitation special, consequential or incidental damages. "Typical" parameters which may be provided in SCILLC data sheets and/or specifications can and do vary in different applications and actual performance may vary over time. All operating parameters, including "Typicals" must be validated for each customer application by customer's technical experts. SCILLC does not convey any license under its patent rights nor the rights of others. SCILLC products are not designed, intended, or authorized for use as components in systems intended for surgical implant into the body, or other applications intended to support or sustain life, or for any other application in which the failure of the SCILLC product could create a situation where personal injury or death may occur. Should Buyer purchase or use SCILLC products for any such unintended or unauthorized application, Buyer shall indemnify and hold SCILLC and its officers, employees, subsidiaries, affiliates, and distributors harmless against all claims, costs, damages, and expenses, and reasonable attorney fees arising out of, directly or indirectly, any claim of personal injury or death associated with such unintended or unauthorized use, even if such claim alleges that SCILLC was negligent regarding the design or manufacture of the part. SCILLC is an Equal Opportunity/Affirmative Action Employer. This literature is subject to all applicable copyright laws and is not for resale in any manner.

AMEYA360

Components Supply Platform

Authorized Distribution Brand :



Website :

Welcome to visit www.ameya360.com

Contact Us :

➤ Address :

401 Building No.5, JiuGe Business Center, Lane 2301, Yishan Rd
Minhang District, Shanghai , China

➤ Sales :

Direct +86 (21) 6401-6692

Email amall@ameya360.com

QQ 800077892

Skype [ameyasales1](#) [ameyasales2](#)

➤ Customer Service :

Email service@ameya360.com

➤ Partnership :

Tel +86 (21) 64016692-8333

Email mkt@ameya360.com