

Description

Available in through-hole fullpack package, the T1610T-8FP Triac can be used for the on/off or phase angle control function in general purpose AC switching. This device can be directly driven by a microcontroller thanks to its 10 mA gate current requirement.

Provides UL certified insulation rated at 1500 V rms.

Table 1. Device summary

Symbol	Value	Unit
$I_{T(rms)}$	16	A
V_{DRM}, V_{RRM}	800	V
V_{DSM}, V_{RSM}	900	V
I_{GT}	10	mA

Features

- Medium current Triac
- Three triggering quadrants Triac
- ECOPACK[®]2 compliant component
- Complies with UL standards (File ref: E81734)
- 16 A high performance Triac:
 - High T_j family
 - High di/dt family
 - High dV/dt family

Applications

- General purpose AC line load switching
- Motor control circuits
- Small home appliances
- Lighting
- Inrush current limiting circuits
- Overvoltage crowbar protection

1 Characteristics

Table 2. Absolute ratings (limiting values, $T_j = 25\text{ °C}$ unless otherwise stated)

Symbol	Parameter		Value	Unit
$I_{T(rms)}$	On-state rms current (full sine wave)		$T_c = 87\text{ °C}$ 16	A
I_{TSM}	Non repetitive surge peak on-state current (full cycle, T_j initial = 25 °C)	F = 50 Hz t = 20 ms	120	A
		F = 60 Hz t = 16.7 ms	126	
I^2t	I^2t value for fusing, T_j initial = 25 °C		$t_p = 10\text{ ms}$ 95	A^2s
V_{DRM}, V_{RRM}	Repetitive surge peak off-state voltage		$T_j = 150\text{ °C}$ 600	V
			$T_j = 125\text{ °C}$ 800	
V_{DSM}, V_{RSM}	Non repetitive surge peak off-state voltage		$t_p = 10\text{ ms}$ 900	V
di/dt	Critical rate of rise of on-state current $I_G = 2 \times I_{GT}, t_r \leq 100\text{ ns}$		F = 100 Hz 100	A/ μs
I_{GM}	Peak gate current	$t_p = 20\text{ }\mu s$	$T_j = 150\text{ °C}$ 4	A
$P_{G(AV)}$	Average gate power dissipation		$T_j = 150\text{ °C}$ 1	W
T_{stg} T_j	Storage junction temperature range Operating junction temperature range		- 40 to + 150 - 40 to + 150	$^{\circ}C$
T_L	Maximum lead temperature for soldering during 10 s		260	$^{\circ}C$
V_{ins}	Insulation rms voltage, 1 minute		1500	V

Table 3. Electrical characteristics ($T_j = 25\text{ °C}$, unless otherwise specified)

Symbol	Test conditions	Quadrant		Value	Unit
I_{GT}	$V_D = 12\text{ V}, R_L = 30\text{ }\Omega$	I - II - III	Min.	0.5	mA
			Max.	10	
V_{GT}	$V_D = 12\text{ V}, R_L = 30\text{ }\Omega$	I - II - III	Max.	1.3	V
V_{GD}	$V_D = V_{DRM}, R_L = 3.3\text{ k}\Omega, T_j = 150\text{ °C}$	I - II - III	Min.	0.2	V
$I_H^{(1)}$	$I_T = 500\text{ mA}$		Max.	15	mA
I_L	$I_G = 1.2 I_{GT}$	I - III	Max.	20	mA
		II		25	
dV/dt ⁽¹⁾	$V_D = V_R = 536\text{ V}$, gate open	$T_j = 125\text{ °C}$	Min.	250	V/ μs
	$V_D = V_R = 402\text{ V}$, gate open	$T_j = 150\text{ °C}$		170	V/ μs
(di/dt) _c ⁽¹⁾	(dV/dt) _c = 0.1 V/ μs	$T_j = 125\text{ °C}$	Min.	21.6	A/ms
		$T_j = 150\text{ °C}$		15.1	
(di/dt) _c ⁽¹⁾	(dV/dt) _c = 10 V/ μs	$T_j = 125\text{ °C}$	Min.	11.3	A/ms
		$T_j = 150\text{ °C}$		5.0	

1. For both polarities of A2 referenced to A1

Table 4. Static characteristics

Symbol	Test conditions			Value	Unit
$V_T^{(1)}$	$I_{TM} = 22.6 \text{ A}$, $t_p = 380 \mu\text{s}$	$T_j = 25 \text{ }^\circ\text{C}$	Max.	1.55	V
$V_{i0}^{(1)}$	Threshold voltage	$T_j = 150 \text{ }^\circ\text{C}$	Max.	0.85	V
$R_d^{(1)}$	Dynamic resistance	$T_j = 150 \text{ }^\circ\text{C}$	Max.	27	m Ω
I_{DRM} I_{RRM}	$V_{DRM} = V_{RRM} = 800 \text{ V}$	$T_j = 25 \text{ }^\circ\text{C}$	Max.	7.5	μA
		$T_j = 125 \text{ }^\circ\text{C}$		1	mA
	$V_{DRM} = V_{RRM} = 600 \text{ V}$	$T_j = 150 \text{ }^\circ\text{C}$	Max.	3.0	

1. For both polarities of A2 referenced to A1

Table 5. Thermal resistance

Symbol	Parameter	Value	Unit
$R_{th(j-c)}$	Junction to case (AC)	3.3	$^\circ\text{C/W}$
$R_{th(j-a)}$	Junction to ambient (DC)	60	$^\circ\text{C/W}$

Figure 1. Maximum power dissipation versus on-state rms current (full cycle)

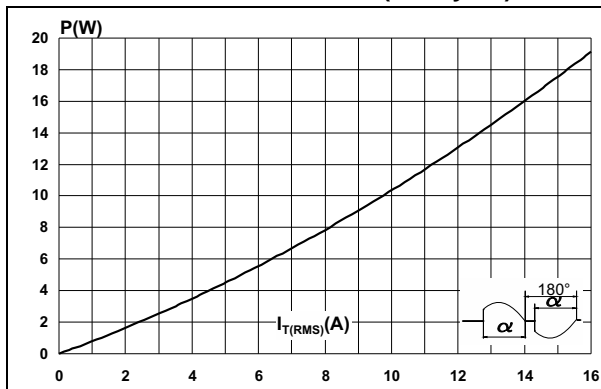

Figure 2. On-state rms current versus case temperature (full cycle)

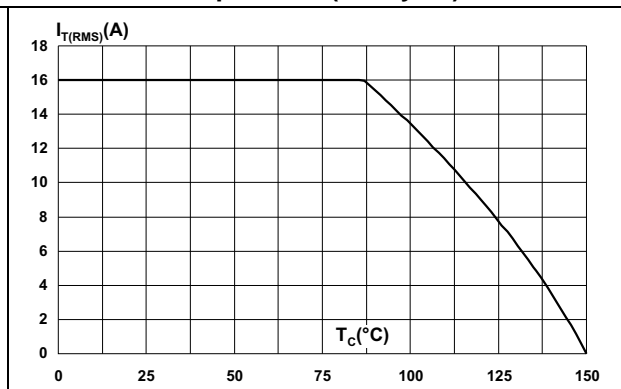

Figure 3. On-state rms current versus ambient temperature (free air convection)

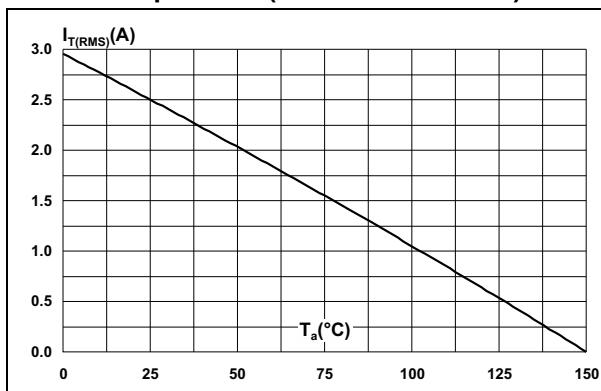

Figure 4. Relative variation of thermal impedance versus pulse duration

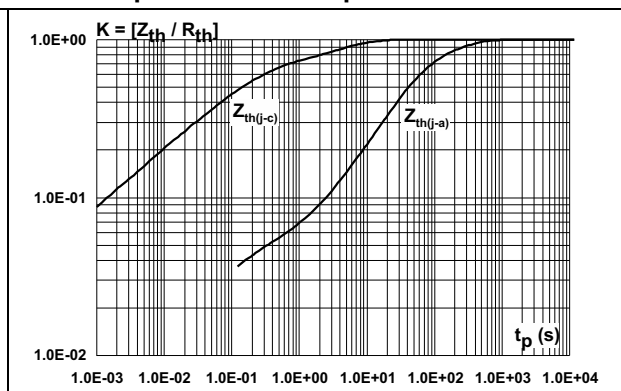

Figure 5. On-state characteristics (maximum values)

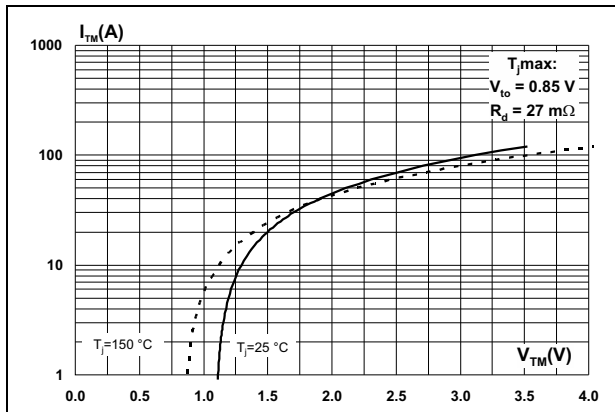

Figure 6. Surge peak on-state current versus number of cycles

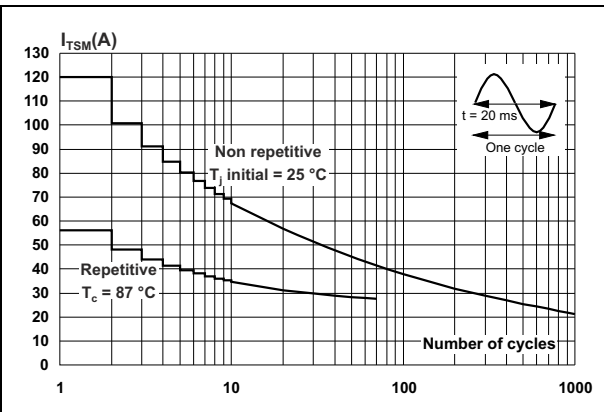

Figure 7. Non repetitive surge peak on-state current and corresponding values of I²t (half cycle)

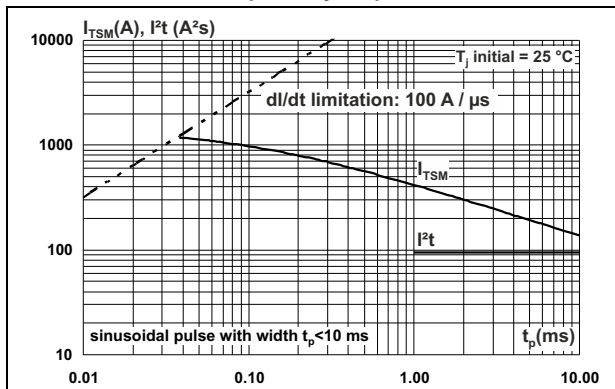

Figure 8. Relative variation of gate trigger current and gate voltage versus junction temperature (typical values)

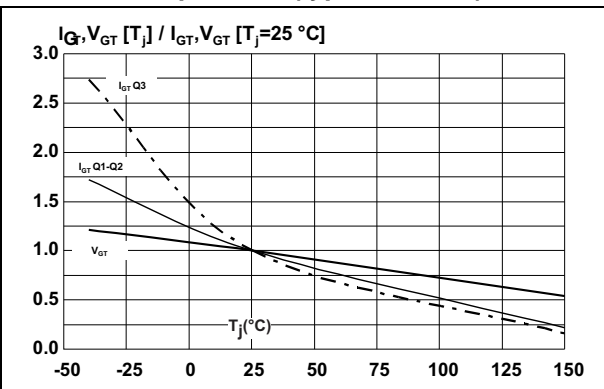

Figure 9. Relative variation of static dV/dt immunity versus junction temperature (typical values)

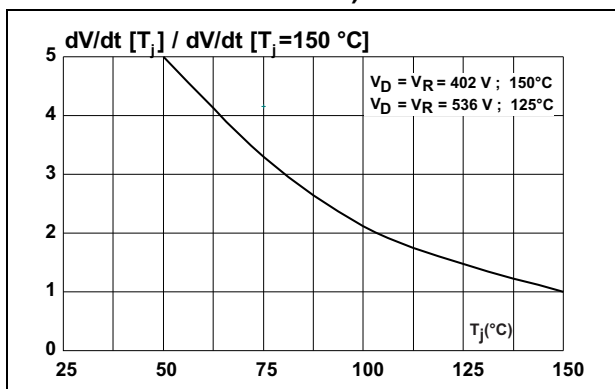

Figure 10. Relative variation of holding and latching current versus junction temperature (typical values)

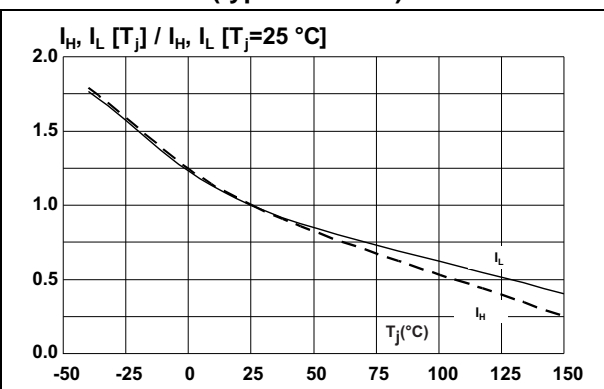

Figure 11. Relative variation of critical rate of decrease of main current (di/dt)_c versus reapplied (dV/dt)_c (typical values)

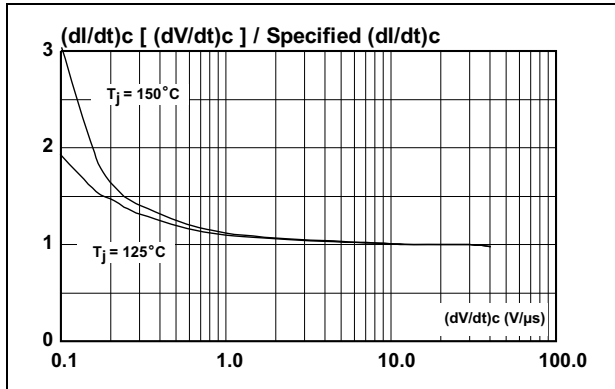

Figure 12. Relative variation of critical rate of decrease of main current (di/dt)_c versus junction temperature (typical values)

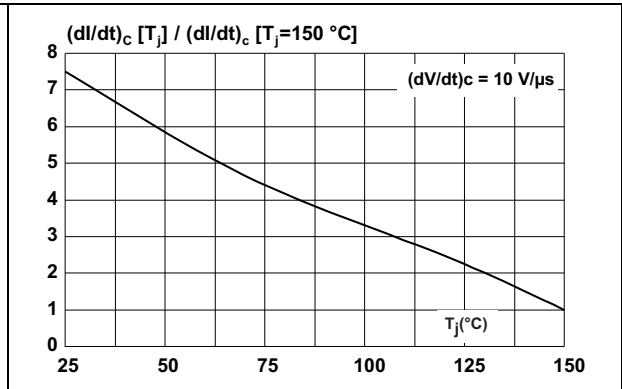
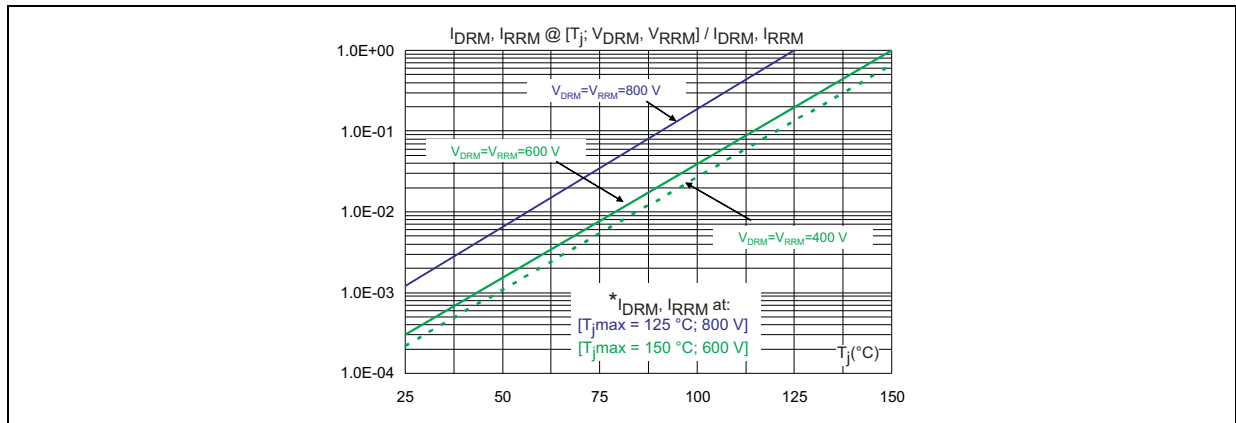

Figure 13. Relative variation of leakage current versus junction temperature for different values of blocking voltage (typical values)



2 Package information

- Epoxy meets UL94, V0
- Lead-free package
- Recommended torque: 0.4 to 0.6 N·m

In order to meet environmental requirements, ST offers these devices in different grades of ECOPACK® packages, depending on their level of environmental compliance. ECOPACK® specifications, grade definitions and product status are available at: www.st.com. ECOPACK® is an ST trademark.

Figure 14. TO-220FPAB dimension definitions

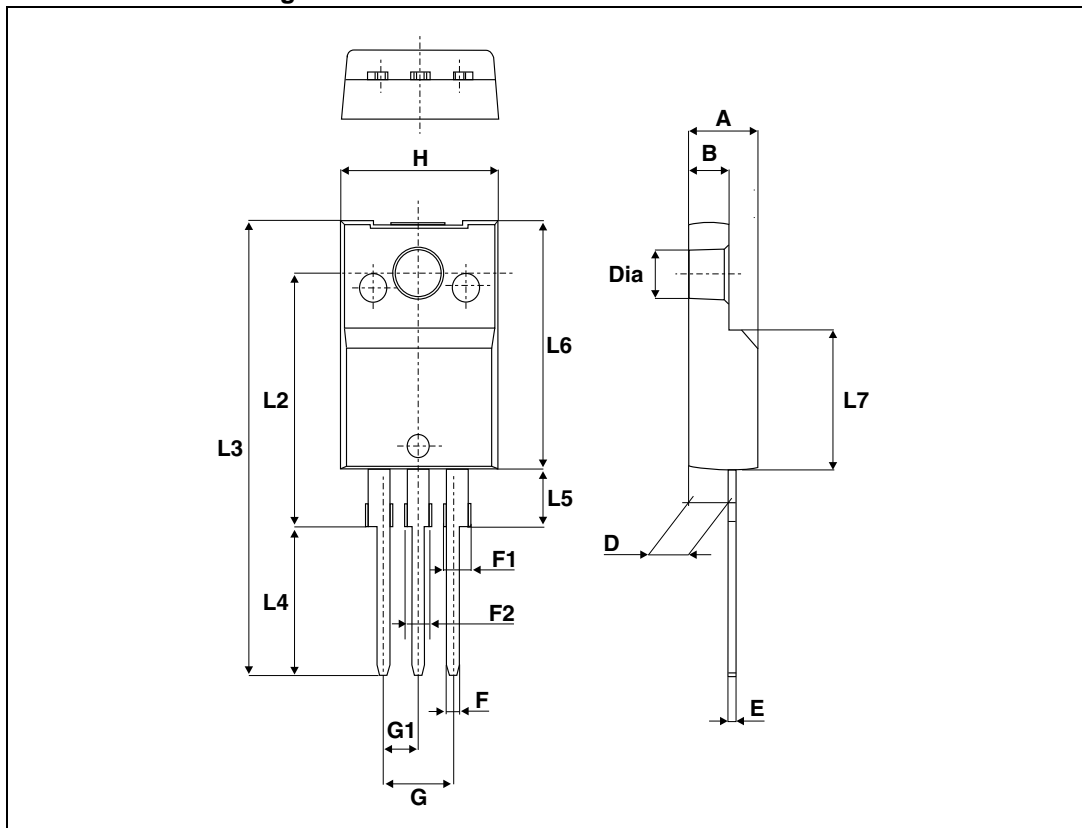

Table 6. TO-220FPAB dimension values

Ref.	Dimensions			
	Millimeters		Inches	
	Min.	Max.	Min.	Max.
A	4.4	4.6	0.173	0.181
B	2.5	2.7	0.098	0.106
D	2.5	2.75	0.098	0.108
E	0.45	0.70	0.018	0.027
F	0.75	1	0.030	0.039
F1	1.15	1.70	0.045	0.067
F2	1.15	1.70	0.045	0.067
G	4.95	5.20	0.195	0.205
G1	2.4	2.7	0.094	0.106
H	10	10.4	0.393	0.409
L2	16 Typ.		0.63 Typ.	
L3	28.6	30.6	1.126	1.205
L4	9.8	10.6	0.386	0.417
L5	2.9	3.6	0.114	0.142
L6	15.9	16.4	0.626	0.646
L7	9.00	9.30	0.354	0.366
Dia.	3.00	3.20	0.118	0.126

3 Ordering information

Figure 15. Ordering information scheme

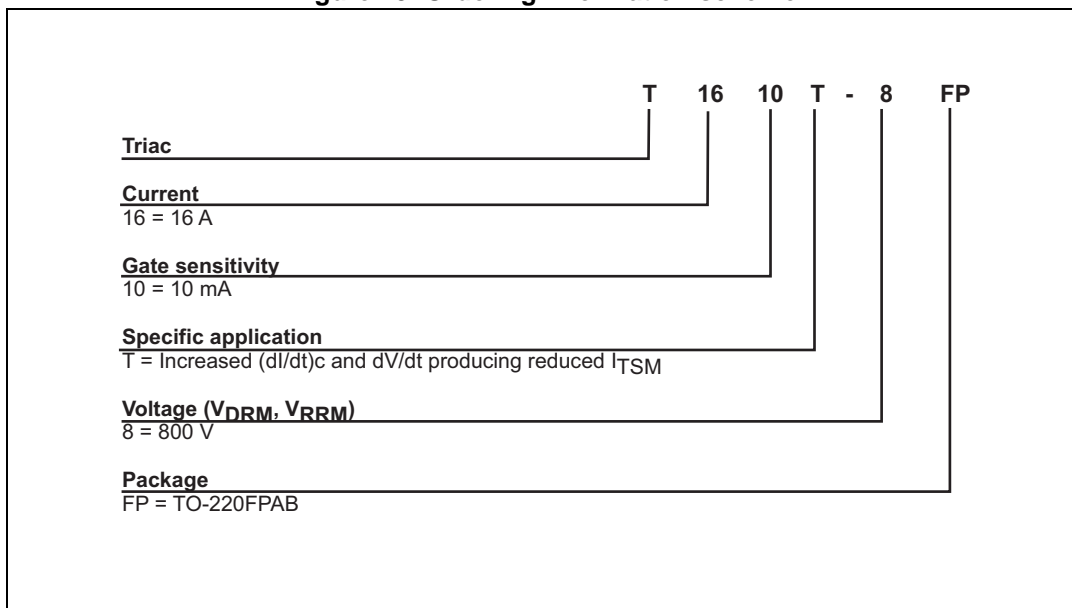

Table 7. Ordering information

Order code	Marking	Package	Weight	Base qty	Delivery mode
T1610T-8FP	T1610T-8FP	TO-220FPAB	2.0 g	50	Tube

4 Revision history

Table 8. Document revision history

Date	Revision	Changes
05-Feb-2014	1	Initial release.

Please Read Carefully:

Information in this document is provided solely in connection with ST products. STMicroelectronics NV and its subsidiaries ("ST") reserve the right to make changes, corrections, modifications or improvements, to this document, and the products and services described herein at any time, without notice.

All ST products are sold pursuant to ST's terms and conditions of sale.

Purchasers are solely responsible for the choice, selection and use of the ST products and services described herein, and ST assumes no liability whatsoever relating to the choice, selection or use of the ST products and services described herein.

No license, express or implied, by estoppel or otherwise, to any intellectual property rights is granted under this document. If any part of this document refers to any third party products or services it shall not be deemed a license grant by ST for the use of such third party products or services, or any intellectual property contained therein or considered as a warranty covering the use in any manner whatsoever of such third party products or services or any intellectual property contained therein.

UNLESS OTHERWISE SET FORTH IN ST'S TERMS AND CONDITIONS OF SALE ST DISCLAIMS ANY EXPRESS OR IMPLIED WARRANTY WITH RESPECT TO THE USE AND/OR SALE OF ST PRODUCTS INCLUDING WITHOUT LIMITATION IMPLIED WARRANTIES OF MERCHANTABILITY, FITNESS FOR A PARTICULAR PURPOSE (AND THEIR EQUIVALENTS UNDER THE LAWS OF ANY JURISDICTION), OR INFRINGEMENT OF ANY PATENT, COPYRIGHT OR OTHER INTELLECTUAL PROPERTY RIGHT.

ST PRODUCTS ARE NOT DESIGNED OR AUTHORIZED FOR USE IN: (A) SAFETY CRITICAL APPLICATIONS SUCH AS LIFE SUPPORTING, ACTIVE IMPLANTED DEVICES OR SYSTEMS WITH PRODUCT FUNCTIONAL SAFETY REQUIREMENTS; (B) AERONAUTIC APPLICATIONS; (C) AUTOMOTIVE APPLICATIONS OR ENVIRONMENTS, AND/OR (D) AEROSPACE APPLICATIONS OR ENVIRONMENTS. WHERE ST PRODUCTS ARE NOT DESIGNED FOR SUCH USE, THE PURCHASER SHALL USE PRODUCTS AT PURCHASER'S SOLE RISK, EVEN IF ST HAS BEEN INFORMED IN WRITING OF SUCH USAGE, UNLESS A PRODUCT IS EXPRESSLY DESIGNATED BY ST AS BEING INTENDED FOR "AUTOMOTIVE, AUTOMOTIVE SAFETY OR MEDICAL" INDUSTRY DOMAINS ACCORDING TO ST PRODUCT DESIGN SPECIFICATIONS. PRODUCTS FORMALLY ESCC, QML OR JAN QUALIFIED ARE DEEMED SUITABLE FOR USE IN AEROSPACE BY THE CORRESPONDING GOVERNMENTAL AGENCY.

Resale of ST products with provisions different from the statements and/or technical features set forth in this document shall immediately void any warranty granted by ST for the ST product or service described herein and shall not create or extend in any manner whatsoever, any liability of ST.

ST and the ST logo are trademarks or registered trademarks of ST in various countries.

Information in this document supersedes and replaces all information previously supplied.

The ST logo is a registered trademark of STMicroelectronics. All other names are the property of their respective owners.

© 2014 STMicroelectronics - All rights reserved

STMicroelectronics group of companies

Australia - Belgium - Brazil - Canada - China - Czech Republic - Finland - France - Germany - Hong Kong - India - Israel - Italy - Japan - Malaysia - Malta - Morocco - Philippines - Singapore - Spain - Sweden - Switzerland - United Kingdom - United States of America

www.st.com

AMEYA360

Components Supply Platform

Authorized Distribution Brand :



Website :

Welcome to visit www.ameya360.com

Contact Us :

➤ Address :

401 Building No.5, JiuGe Business Center, Lane 2301, Yishan Rd
Minhang District, Shanghai , China

➤ Sales :

Direct +86 (21) 6401-6692

Email amall@ameya360.com

QQ 800077892

Skype [ameyasales1](#) [ameyasales2](#)

➤ Customer Service :

Email service@ameya360.com

➤ Partnership :

Tel +86 (21) 64016692-8333

Email mkt@ameya360.com