

**eam  
TENENERGY**

**TB6B**

FC CE ♻

Copyright©2010

## Intelligent digital balance charger



**Operating manual**

# TB6B Intellective digital balance Charger

## Operating Manual

1、 Special features.....	1
2、 Performance parameter.....	2
3、 Exterior and accessories.....	2
4、 Key features.....	2
5、 Operating instructions.....	3
6、 Warning and error messages.....	11
7、 Safety messages.....	12
8、 After-sale service and guarantee.....	12

## 7.Safety message

Although the charger is designed to work in a stable environment to play a role, but in use, you still need careful maintenance, as long as these important tips to follow, that is easy and effective use of your charger!

- 1) When you start the process, especially the discharge process, the unit will become warm, please keep clear of the heat area and do not cover it by anything when using
- 2) Do not keep it in an environment below 5 °C or above 50 °C
- 3) Use it carefully, do not use it in a wet or corrosive environment
- 4) Keep all the inflammable volatile materials well away from operating area.
- 5) Please don't let the charger get hurt through falling, bumping, striking, shaking, heavy press and so on.
- 6) Do not attempt the voltage higher than the requirement by manufactures
- 7) Ensure the type of battery and the voltage of the battery pack is selected correctly. Do not use the different types or different capacities synchronously.
- 8) The standard accessories can only support one battery pack. When you are willing to use multi-packs, please separately purchase the special accessories, never do a disassembly or alteration to the charger
- 9) Do not attempt to charge/discharge the non-recharged battery or damaged battery.
- 10) Keep the charger away from children and pet at all time! Never leave the charger unsupervised when it is connected to its power supply.

## 8.After-sale service and guarantee

Thank you for purchasing this balance charger, we will do our best to provide you with a comprehensive after-sale service and protect your rights and interests. Since you purchase the unit, you can enjoy the lifelong guarantee service.

We warrant this product for a period of one year from the date of purchase, if it has a quality problem itself, all guarantee will be free; In case customers can not provide an effective certificate of purchase, we will refer the date of machine's internal.

If it is over one year since the purchase date, an appropriate cost will be charged, users need to bear the transportation cost back and forth.

User disassembly, alteration, or damage caused by improper use, they should bear the maintenance and transport costs.

### After-sale procedure:

When you can not use the product normally, please contact the local franchiser or the after-sale service person. After products have been confirmed damaged or unable to confirm the causes, you can send it to the company directly or through the franchiser.

We will normally repair completed and send it to customers within five working days after receive it.

All rights revised by TENERGY to commit modifications.

## 1. Special features:

- 1.1 This charger employs an advanced charging calculation and design which allow multilayer error to be compatible. It can create a safe charging condition and maximum reduce the danger caused by negligence or setting error of user
- 1.2 This item adopt prevalent Synchronous buck & boost converter technology, this makes conversion efficiency up to 90%
- 1.3 Accept all types of R/C batteries: LiPo, Lilo, LiFe, NiMH, NiCd, Pb.
- 1.4 Simple and efficient user interface makes operation easy, with powerful function and abundant content. Real-time shows you the battery voltage, charge current, temperature of batteries, capacity of charge/discharge, elapsed time, input voltage etc., therefore, you can inquire the present state and establish various safety-limited parameters conveniently.
- 1.5 This charger employs an individual-cell-voltage balancer to maintain your pack in balance while charging/discharging. During the process, it can monitor and balance each cell of the pack individually (Tolerance:  $\pm 0.01V$ )
- 1.6 Accept individual battery charging/discharging, so you can extend the scope of application of the charger that is equally useful for the DIY battery.
- 1.7 Various of charging mode to meet different demand: charging-auto /balance charging/fast charging/storage and cyclic charging etc.
- 1.8 For users convenience it can store and load maximum five data of different batteries, you can establish the data contains program setting of the battery to charge or discharge continually, these data can be called out at any time you need and the process can be executed without program setting.
- 1.9 Perform 1-5 cycles of charge>discharge or discharge>charge continually for NiMH / NiCd refreshing
- 1.10 You can connect a high-precision digital temperature sensor to protect the charger works in a safety temperature, once a battery reaches the maximum temperature you set during charge/discharge, the process will be terminated to protect the battery, this is very important for NiMH / NiCd (separately purchased temperature sensor)

## 2. Performance parameter:

2.1 Input voltage range	DC10.5~18.0V
2.2 Charge current range	0.1~5.0A
2.3 Discharge current range	0.1~1.0A
2.4 Charge power limited	max.50W
2.5 Discharge power limited	max.5W
2.6 Balance current	max.250mA
2.7 Balance tolerance	±0.01V
2.8 NiCd/NiMH battery cell count	1~15cells
2.9 Lithium battery types	Li-po, Li-ion, Li-Fe
2.10 Lithium battery cell count	1-6series
2.11 Pb battery voltage	2-20V(1~10cells)
2.12 Weight:	260g
2.13 Dimensions:	130X85X26mm

## 3. Exterior and accessories



## 4. Key features:

**Mode Esc** : mode selection/stop/back button. Press this key to select in the main menu or back to the main menu, and to stop during the process.

**Dec./Inc.** : reduce and increase button, you can browse other concerning informations by this button during the charge/discharge process. When you are setting parameters, press **Dec.** key for reduce, and **Inc.** key for increase.

**Enter/Start** : select/enter button, to start work by press it more than 2 seconds.

## 6. Warning and error messages

- REVERSE POLARITY** → The output is connected to a battery with incorrect polarity
- CONNECTION BREAK** → This will be displayed in case of detecting an interruption of the connection between battery and output or voluntarily disconnecting the charge lead during the operation of charge or discharge on output
- SHORT ERR** → There was a short-circuit at output, please check the charging leads.
- INPUT VOL ERR** → The voltage of input power drops below the limit.
- VOL SELECT ERR** → The voltage of Lithium battery pack was selected incorrectly. Verify the voltage of battery pack carefully
- BREAK DOWN** → There happens the malfunction at the charger circuit by any reason.
- BATTERY CHECK LOW VOLTAGE** → The processor detects the voltage is lower than you set at Lithium program, please check the cell count of the battery pack.
- BATTERY CHECK HIGH VOLTAGE** → The processor detects the voltage is higher than you set at Lithium program, please check the cell count of the battery pack.
- BATTERY VOLTAGE CELL LOW VOL** → The voltage of one of the cell in the Lithium battery pack is too low, please check the voltage of the cell one by one.
- BATTERY VOLTAGE CELL HIGH VOL** → The voltage of one of the cell in the Lithium battery pack is too high, please check the voltage of the cell one by one.
- BATTERY VOL ERR CELL CONNECT** → There are bad connection at the individual connector, please check the connector and cables carefully
- TEMP OVER ERR** → The internal temperature of the unit goes too high, cool down the unit.
- CONTROL FAILURE** → The processor can not continue to control the feeding current by any reason. The unit needs to be repaired.



### 5.5.1 charging Pb battery



As you can see on left, you can set up the charge current on the left. the nominal of the second line and voltage of the battery on the right of the second line. the charge current ranges from 0. 1-5. 0A and the voltage should be matched with the battery being charged. start the charge process by pressing **Enter Start** key for more than 2 seconds.



The screen displays the state of charging process. to stop charging forcibly, press **Mode Esc** key once.

### 5.5.2 discharging Pb battery



Set discharge current on the left and final voltage on the right, the discharge current ranges from 0. 1-1.0A and the voltage should be matched with the battery being discharged. start the discharge process by pressing **Enter Start** key for more than 2 seconds.



The screen displays the current state of discharge.

### 5.6 save data and load data program

This charger can store/load up to 5 batteries data, you can call out the data for the process without setting up the program again.

#### 5.6.1 save data



Press **Mode Esc** key to the screen on the left. then press **Enter Start** key to enter into the submenu.



The blinking (01) shows you the data NO, you can press **Dec./Inc.** key to change it. Press **Enter Start** key can select the type of battery, voltage, capacity, and you can set them by pressing **Dec./Inc.** Key. then press **Enter Start** key for more than 2 seconds to select the charge mode



Setting up charge/discharge current and final voltage.

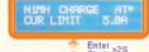

To save the data, press **Enter Start** key for more than 2 seconds.

#### 5.6.2 load data



Press **Mode Esc** key to the screen on the left. then press **Enter Start** key to enter the submenu.



You can press **Dec./Inc.** key to select the data number when the (01) field is blinking.

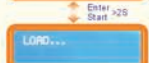

Press **Enter Start** key for more than 2 seconds, it will shows you the left screen, loading the data

## 5. Operating instructions.:

### 5.1 main menu

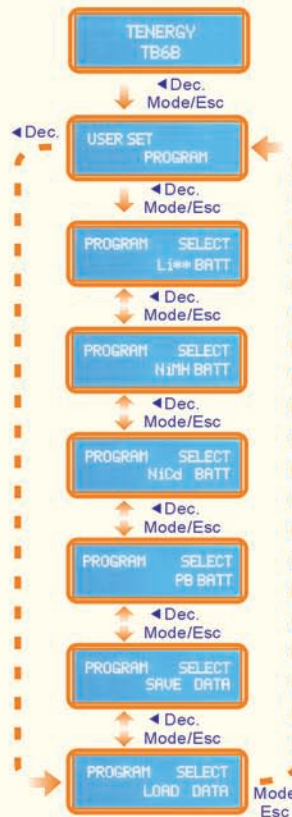

This Shows you the type of charger for 2s, press **Enter Start** into the main menu after self-check OK

User set program, press **Mode Esc** key adown and **Dec.** key upward for circulatory choose. press **Enter Start** key into submenu.

Lithium battery program, press **Mode Esc** key adown and **Dec.** key upward for circulatory choose. Press **Enter Start** key into submenu.

NiMH battery program, Press **Mode Esc** key adown and **Dec.** key upward for circulatory choose. press **Enter Start** key into submenu.

NiCd battery program, Press **Mode Esc** key adown and **Dec.** key upward for circulatory choose. press **Enter Start** key into submenu.

Pb battery program, Press **Mode Esc** key adown and **Dec.** key upward for circulatory choose. press **Enter Start** key into submenu.

Save data program, Press **Mode Esc** key adown and **Dec.** key upward for circulatory choose. press **Enter Start** key into submenu.

Load data program, Press **Mode Esc** key adown and **Dec.** key upward for circulatory choose. press **Enter Start** key into submenu.

## 5.2 Initial parameter set up

Tips: please set up correctly in the "user set" menu before into the job for the first time you use it

Press **Enter/Start** key to the first screen below, then press **Mode/Esc** key to enter the into parameter setting menu.

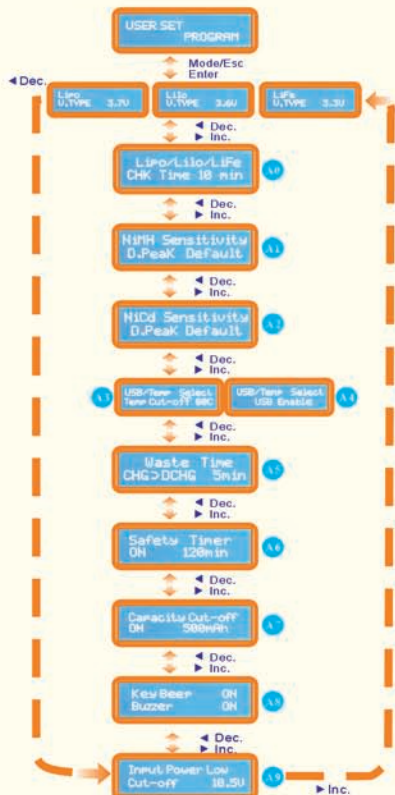

You can switched at the same level menu by **Dec./Inc.** key, please refer the detailed flow chart on the left

When you are willing to alter the parameter value in the program, press **Enter/Start** key to make it blink, then change the value with **Dec./Inc.** key, the value will be stored by press **Enter/Start** key once.

This charger can accept three types of Lithium batteries: LiPo/LiIo/LiFe; you have to check the battery carefully and set it up correctly, or it will cause a explode! (Please refer the table A)

This charger can recognise the cell count of Lithium battery automatically at the beginning of charge or discharge process to avoid from erroneous setting by user, but deeply discharged battery can be perceived incorrectly. To prevent the error, you can set the time term to verify the cell count by the processor. ( see the screen ④) Normally, 10 minutes are enough to perceive it correctly. For the battery of larger capacity, you may extend the time term, and for the battery of smaller capacity, you may reduce the term or use with the default value

## 5.4 NiMH/NiCd battery program

Press **Mode/Esc** key to the screen on the left, then press **Enter/Start** key to **Enter** into the submenu. You can switched at the same level menu to select the mode by **Dec./Inc.** Key, please refer the detailed flow chart on the left. When you are willing to alter the parameter value in the program, press **Enter/Start** key to make it blink, then change the value with **Dec./Inc.** key, the value will be stored by pressing **Enter/Start** key once, then press **Enter/Start** key for more than 2 seconds to start the process. since the menu of NiMH are the same as NiCd, there is an example of NiMH only.

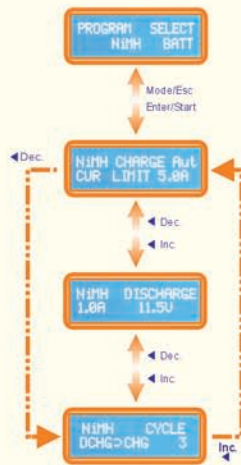

"CHARGE" mode the default mode is "AUT" in "AUT" mode, you need to set the upper limit of charge current to avoid from higher feeding current that may damage the battery. Because some batteries of low impedance and small capacity can lead to the higher charge current by the processor at automatic charge mode. But in "Man" mode, it will charge the battery with the charge current you set at the display. Each mode can be switched by pressing start/enter key, when the current field is blinking, press **Dec./Inc.** Key for more than 1 second.

"DISCHARGE" mode the discharge current ranges from 0.1A to 1.0A and the final voltage ranges from 0.1 to 25.0V, the operating method is similar as Lithium battery, the final voltage of NiMH battery is 1.0V/cell, and the NiCd is 0.85V/cell, please refer the recommend by the battery of manufacturer.

"CYCLE" mode this charger can perform 1-5 cycles of DCHG > CHG or CHG > DCHG continually. You can select it for the new Ni\*\* battery or the long-term placement Ni\*\* battery. please set up carefully, or it will damage the battery! to the parameter please follow the previous charge/discharge menu

### 5.4.1 After check all the mode, to start the process press **Enter/Start** key for more than 2 seconds

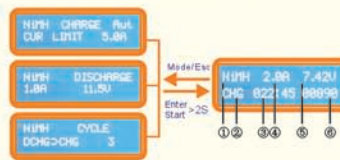

The screen displays the present state of process. To stop it press **Mode/Esc** key; Description: ①: the type of battery, ②: operating mode: CHG=charge, DSC=discharge, DCHG>CHG or CHG>DCHG=the cycle mode; ③: elapsed time, ④: charge/discharge current of the battery, ⑤: voltage of the battery pack, ⑥: capacity of charge/discharge

You can inquire the temperature and  $\Delta V$  continually by press **Dec./Inc.** key

## 5.5 Pb battery program

This is programmed for charging Pb battery with nominal voltage from 2 to 20V, Pb battery can not be charged rapidly, they can only deliver relatively lower current compare to their capacity, the optimal charge current will be 1/10 of the capacity, please always follow the instruction supplied by the manufacturer of battery.



5.3.2 According to press **Dec./Inc.** key you can inquire the individual voltage of each batteries and final voltage etc.continually as follow (this need to connect the balance plug):

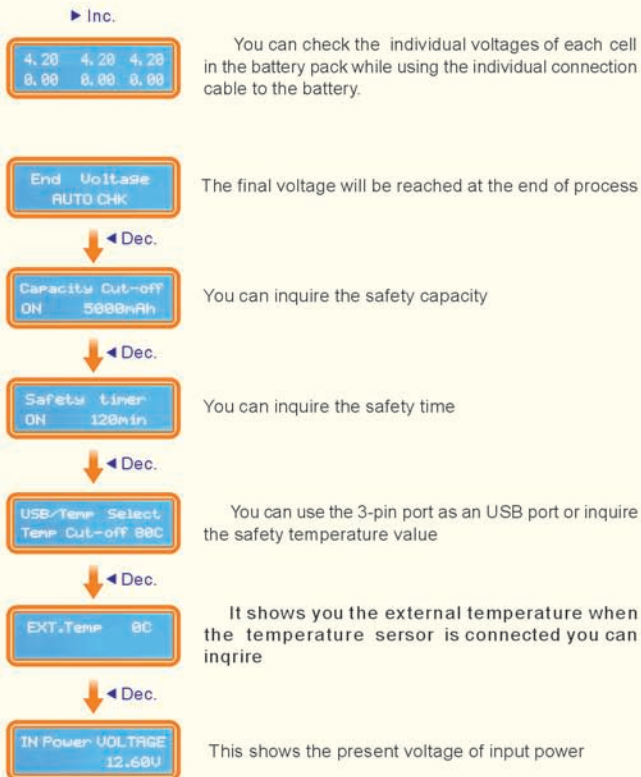

**1** **2** shows the trigger voltage for automatic charge termination of NiMH and NiCd battery ( $\Delta V$ ), the effective value ranges from 5 to 20mV per cell. If  $\Delta V$  is set higher, there is a danger of overcharging the battery; if it is set lower, there is a possibility of premature termination. please refer technical specification of the battery. (NiCd: 12mV, NiMH:7mV)

**Tips:** If the voltage of charging battery is lower than 2.5V,  $\Delta V$  may not be perceived, this will cause a danger of discharge. You can connect a temperature sensor or use the charger current above 1C to avoid it.

There is a 3-pin port on the left side of the unit. It can be used as a temperature sensor or USB port. If the port is assigned as a temp. port, you can use an optional temperature probe to contact the surface of battery (see the screen **1**) and you can set the maximum temperature at which the danger should allow battery to reach during charge, once a battery reaches this value the process will be terminated to protect the battery. When it is selected as an USB port, you can connect the charger to your PC with an optional USB cable. this can utilize the optional software that can show you the charge process at PC. (see the screen **1**)

When NiMH or NiCd battery is on the cyclic process of charge/discharge, it can often become warm. The program insert a time delay to occur after each charge and discharge process to allow the battery adequate time to cool down before being subjected to the next process. (see the screen **1**) the value ranges from 1 to 60 minutes. If you are not sure, you can set it over 10 minutes.

When you start a charge process, the integral safety timer automatically starts running at the same time. this is programmed to prevent overcharge the battery if it proves to be faulty, or if the termination circuit cannot detect the battery full. **1** shows you this program can be on or off, and you can set the maximum safety time, the value ranges from 10 to 720min. As the same principle, there is a maximum-capacity-limited function. See **1**, the value ranges from 10 to 20000mAh.

At the screen **1** you can set the audible sounds to be on or off by this program.

When you use the car battery to supply power for charger, screen **1** shows you this program monitors the voltage of input DC battery. If the voltage drops below the value you set the operation forcibly terminated to protect the input battery.

**Please refer the information below (chart A). and select the correct parameter for each battery, or it will cause a serious result!**

chart A

types	Li-Po	Li-10	Li-Fe	NiMH	NiCD	Pb
Standard voltage (V/cell)	3.70	3.60	3.30	1.20	1.20	2.00
Max. Charge voltage cut off level (V/cell)	4.20	4.10	3.60	1.60	1.60	2.45
Allowable fast current	<1C	<1C	<4C	<2C	<2C	<0.4C
Min Discharge voltage cut off level (V/cell)	>3.00	>3.00	>2.00	>1.00	>0.85	>1.75

### 5.3 Lithium batteries (Lilo/LiPo/LiFe) program



Press **Mode/Esc** key to the screen on the left, then press **Enter/start** key to enter into the parameter setting menu. You can switched at the same level menu by **Dec./inc.** key. Please refer the detailed flow chart on the left. When you are willing to alter the parameter value in the program, press **Enter/start** key to make it blink, then change the value with **Dec./inc.** key. The value will be stored by pressing **Enter/start** key once, then press **Enter/start** key for more than 2 seconds to start the process.

"AUTO charging" this is for individual Lithium battery or some special battery pack without balance port or cell count. The left side of the first line shows the type of battery you select at the user setting. The right side of the first line shows you the mode of charge. The value on the left side of second line sets a charge current and the value on the right side of second line sets the cells count of the battery, the definition of the following screen are all the same. (To know how to connect, please refer picture B)

"Balance charging" this is for 2-6 cells of Lithium battery with balance port, the battery pack being charged should have the individual cell connect, and connect it to the individual port at the right side of charger with a suitable connection cable that fits with your battery pack. (see picture B) In this mode, the charging process will be different from ordinary charging mode, the internal processor of the charger will monitor and control the voltage of each cell of the battery pack. This can improve the discharging performance of the battery! EV charger use the optimized calculation to control the tolerance in the range of  $\pm 0.01V$ !

"Fast charging" select this mode to finish charging process earlier. Principle: When the current down to 1/5 of the current you set during the CV term, it will stop the process and eliminate the forcible requirement of the balance precision. (whether it is been connected to the balance port), the charging capacity may be a bit smaller than normal charging but the process time will be reduced.

"Storage mode" this is for charging or discharging Lithium battery not to be used for the time being. In order to reduce the wastage, you can select this mode to remain the power to 40% to store. The final voltage are different from the type of the battery. Lilo:3.75V. LiPo:3.85V. LiFe:3.3V. This is an intellective program. If the voltage of battery at its initial stage is over the voltage level to storage, the program will start to discharge, and if it is lower, the program will start to charge automatically. In order to ensure each battery meets the demand, the individual plug of the battery pack should be connected to the individual port of charger.

"Discharge mode" theoretically, Lithium battery do not need to discharge, especially deep-discharge. This feature is to ensure the power wastage of the Lithium battery over 90%, to avoid the overcharge of the individual battery, you should connect the balance plug of the battery to the charger, and the current may not exceed 1C.

### Picture B



connection diagram in the Auto charging mode



connection diagram in the balance charging /storage/discharge mode

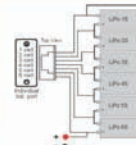

Individual cell connection diagram

#### 5.3.1 Start to charge/discharge: after set up the mode menu correctly, press **Enter/start** key for more than 2 seconds to start the process.

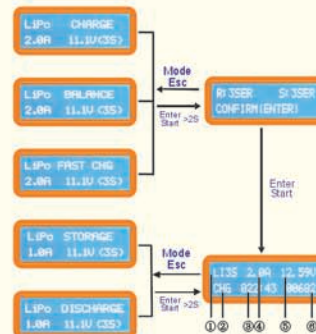

This screen shows the number of cells you set up and the processor detects. "R" shows the number of cells found by charger and "S" is the number of cells selected by you at the previous menu. If both number are identical you can start charging by press **Enter/start** button, if not, press **Mode/Esc** button to go back to previous menu, then carefully check the number of cells of the battery pack to charge again. If you selected the AUTO mode or discharge mode, you can pass over this screen directly.

This screen shows the present situation during charge process. to stop charging press **Mode/Esc** key once; As you can see in the sketch on left, ①: for the cells count, ②: for the operating mode, CHG=charging at auto mode, BAL=balance charging mode, FAS=fast charging, STO=storage mode, DSC=discharge mode, ③: elapsed time, ④: charge/discharge current, ⑤: charge/discharge voltage of battery, ⑥: capacity of charge/discharge



# AMEYA360

## Components Supply Platform

Authorized Distribution Brand :



Website :

Welcome to visit [www.ameya360.com](http://www.ameya360.com)

Contact Us :

➤ Address :

401 Building No.5, JiuGe Business Center, Lane 2301, Yishan Rd  
Minhang District, Shanghai , China

➤ Sales :

Direct +86 (21) 6401-6692

Email [amall@ameya360.com](mailto:amall@ameya360.com)

QQ 800077892

Skype [ameyasales1](#) [ameyasales2](#)

➤ Customer Service :

Email [service@ameya360.com](mailto:service@ameya360.com)

➤ Partnership :

Tel +86 (21) 64016692-8333

Email [mkt@ameya360.com](mailto:mkt@ameya360.com)