	TYPE	PRODUCT SPECIFICATION		NUMBER	110-263
	TITLE	68POS. Memory Card Connectors based on JEIDA Ver4.1/PCMCIA			PAGE
				AUTHORIZED BY	Miao SH
				REVISION	D
				DATE	5/12/09
				CLASSIFICATION	Unrestricted

1.0 OBJECTIVE

This specification covers the standard performance and evaluating conditions of 68Pos.Memory Card Connectors based on JEIDA IC Memory-Card Guidelines Ver. 4.1 and PCMCIA PC card Standard Release 2.0.

2.0 SCOPE

All products of and memory card connectors based on JEIDA Ver.4.1 and PCMCIA Release 2.0 shall conform to this specification.

3.0 GENERAL

This document is composed of the following sections:

<u>Paragraph</u>	<u>Title</u>
1.0	OBJECTIVE
2.0	SCOPE
3.0	GENERAL
4.0	REQUIREMENT
5.0	CONSTRUCTION
6.0	PERFORMANCE
7.0	TEST METHOD

4.0 REQUIREMENT

4.1 Metallic components

- 1). Terminals ---Beryllium copper with nickel underplating.
(Socket Connector) Contact area---0.38 μ m or 0.75 μ m GXT.
Solder tail ---Solder plating of 2.5 μ m min. thick.
or Au Flash plating for "LF" suffix parts number.
- 2). Terminals (Header) ---Phosphor bronze with nickel underplating.
Contact area---Option 1: 0.38 μ m or 0.75 μ m GXT.
Option 2 : Gold plating of 0.25 μ m min thick.
Option 3 : Gold Flash plating.
Solder tail ---Solder plating of 2.5 μ m min. thick.
or Sn plating 2.5 μ m min. thick.
or Au Flash plating.

4.2 Plastic components

- 1). Socket housing --- Glass filled 66-Nylon or Glass filled PPS or Glass filled LCP.
UL94V-0.
- 2). Header housing --- Glass filled 66-Nylon or Glass filled LCP.UL94V-0.

	TYPE PRODUCT SPECIFICATION	NUMBER 110-263	
TITLE 68POS. Memory Card Connectors based on JEIDA Ver4.1/PCMCIA		PAGE 2 of 13	REVISION D
		AUTHORIZED BY Miao SH	DATE 5/12/09
CLASSIFICATION Unrestricted			

5.0 CONSTRUCTION

The connector consists of a socket connector and a header.
 Attach a dummy card to the socket connector before inserting the socket connector into the header.
 Fig. 5.1 shows a typical construction of the connector.

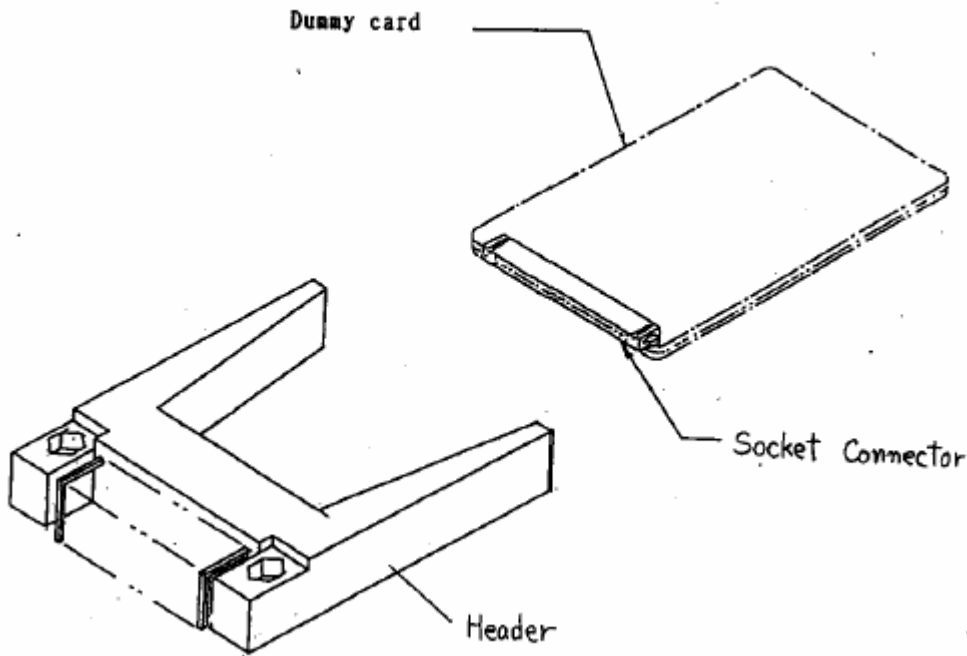



Fig. 5.1 Construction

	TYPE	PRODUCT SPECIFICATION		NUMBER	110-263
	TITLE	68POS. Memory Card Connectors based on JEIDA Ver4.1/PCMCIA		PAGE	3 of 13
				REVISION	D
				AUTHORIZED BY	Miao SH
				DATE	5/12/09
				CLASSIFICATION	Unrestricted

6.0 PERFORMANCE

Unless otherwise noted, the performance of connectors given in the attached list shall satisfy the values specified in Table 5.1. The performance test shall follow the sequence given in Table 5.2. under the environmental condition(JIS C0010) listed below. All connectors to be tested shall be free of defects such as burr, flaw, void, chip, blister, pinhole, or sharp edge, which affect the life and Application of the connector.

Temperature -----15 – 35 °C
Humidity -----25 – 85 %
Pressure -----86 – 106 kPa(860 – 1060kPa)

6.1 performance

Table 6.1.Performance

	TYPE	PRODUCT SPECIFICATION		NUMBER	110-263		
	TITLE			PAGE	4 of 13		REVISION
68POS. Memory Card Connectors based on JEIDA Ver4.1/PCMCIA			AUTHORIZED BY	Miao SH		DATE	5/12/09
			CLASSIFICATION			Unrestricted	

Item	Specification	Test method
Electrical :		
Rated current	Max. rated current - 0.5A.D.C (per pos.)	--
Contact resistance (low level)	Initail - 40 m Ω max. After the test - 20 m Ω max. change from the initial value	7.1
Insulation resistance	Initail - 1,000 m Ω min. After the test - 100 M Ω min.	7.2
Dielectric withstand- ing voltage	No abnormality shall occur or leak current shall be 1 mA max. after applying AC 500 V for 1 min.	7.3
Temperature rise	30 °C max.(at rated current)	7.4
Environmental	After the test	
Humidity (steady state)	Insulation resistance - 100 M Ω min. Contact resistance - 20 m Ω max. change from the initial value	7.5
Miosture resistance	After the test, the change in contact resistance shall be 20 m Ω max. from the initial.	7.6
Thermal shock	After the test, no evidence of crack, blister, or rust which affect the funciton of connector. Insulation resistance - 100 M Ω min. contact resistance - 20 m Ω max. change from the initial value	7.7

	TYPE	PRODUCT SPECIFICATION	NUMBER	110-263
	TITLE		PAGE	REVISION
68POS. Memory Card Connectors based on JEIDA Ver4.1/PCMCIA		5 of 13		D
		AUTHORIZED BY	DATE	
		Miao SH	5/12/09	
		CLASSIFICATION	Unrestricted	

	High temperature exposure	After the test, contact resistance shall be 20 m Ω max. change from the initial.	7.8
	Low temperature exposure	After the test, contact resistance shall be 20 m Ω max. change from the initial.	7.9
	Hydrogen sulfide (H2S)	After the test, contact resistance shall be 20 m Ω max. change from the initial.	7.10
	Salt spray	After the test, no evidence of crack, blister, or rust which affect the function of connector. 20 m Ω max. change from the initial in contact resistance	7.11
Mechanical :	Durability (office environment)	After the test, the change in contact resistance shall be 20 m Ω max. from the initial.	7.12
	Durability (harsh environment)	After the test, the change in contact resistance shall be 20 m Ω max. from the initial.	7.13
	Vibration	After the test, no looseness nor damage of the mated parts shall be found. During the test, no discontinuity over 100 n sec. Shall occur.	7.14
	Shock	The change in contact resistance shall be 20 m Ω max. from the initial.	7.15
	Total mating force	4 kg MAX. / 0.68kg MIN	7.16
	Total unmating force	4 kg MAX. / 0.68kg MIN	
	Terminal withdrawal	10 g min. per position withdrawal force. (at initial)	7.17
	Terminal retention force	1.0 kg min. per header pin. 0.5 kg min. per socket terminal.	7.18
	Solderability	bath shall be wet with solder.	7.19
	Solder-heat resistance	No evidence of crack or warp which affect connector function.	7.20

	TYPE	PRODUCT SPECIFICATION	NUMBER	110-263
	TITLE	68POS. Memory Card Connectors based on JEIDA Ver4.1/PCMCIA		PAGE 6 of 13 REVISION D AUTHORIZED BY Miao SH DATE 5/12/09 CLASSIFICATION Unrestricted

6.2 Test sequence

Table 6.2 Test sequence

Test Item		Test Group																			
		1	2	3	4	5	6	7	8	9	10	11	12	13	14	15	16	17	18	19	20
Contact resistance (low level)	6.1				① ③	① ③	① ③	① ③	① ③	① ③	① ③	① ③	① ③	① ③							
Insulation resistance	6.2	① ④	① ④																		
Dielectric with-standing voltage	6.3	② ⑤	② ⑤																		
Temp. rise	6.4			①																	
Humidity	6.5	③			②																
Moisture resistance	6.6					②															
Thermal shock	6.7		③				②														
High temperature	6.8							②													
Low temperature	6.9								②												
Hydrogen sulfide	6.10									②											
Salt spray	6.11										②										
Durability (Office environment)	6.12											②									
Durability (Harsh environment)	6.13												②								
Vibration	6.14													②							
Shock	6.15														②						
Total mating/unmating force	6.16															①					
Terminal withdrawal force	6.17																①				
Header pin retention force	6.18																	①			
Socket terminal retention force	6.18																		①		
Solderability	6.19																				①
Solder-heat resistance	6.20																				①

	TYPE	PRODUCT SPECIFICATION		NUMBER	110-263
	TITLE	68POS. Memory Card Connectors based on JEIDA Ver4.1/PCMCIA		PAGE	7 of 13
				REVISION	D
				AUTHORIZED BY	Miao SH
				DATE	5/12/09
				CLASSIFICATION	Unrestricted

7.0 TEST METHOD

7.1 Contact resistance (low level)

Contact resistance (low level) of mated connector shall be determined in accordance with Test Method 3002 of MIL-STD-1344. The measure value indicates The electric resistance of the contact area and the bulk of two (header and socket) terminals as illustrated in Fig.6.1

1). Test conditions

Test current : DC 1 mA max.
Open Circuit voltage: DC 20 mA max

7.2 Insulation resistance

insulation resistance of mated connector shall be determined in accordance with Test Method 302 of MIL-STD-202.

1). Test conditions

Applied voltage: DC500 V
Duration :1 minute

2). Measuring position

between adjacent terminals of the mated connector

7.3 Dielectric withstanding voltage

Dielectric withstanding voltage of the mated connector shall be determined in accordance with Test Method 301 of MIL-STD-202.

1). Test conditions

Applied voltage: AC 500V rms
Duration : 1 minute

2). Measuring position

Between adjacent terminals of the mated connector.

7.4 Temperature rise

Temperature rise of the area adjacent to the contact point shall be Determined while carrying the test current through the mated connector.

1). Test conditions

test current: DC 0.5 A

2). Measuring method

Thermocouples or equivalent shall be used.

7.5 Humidity(steady state)

Humidity test of the mated connector shall be carried out in accordance with Test Method 103-B of MIL-STD-202. The measurement shall be done after allowing the connector to stand under the following conditions.

1). Test conditions

Temperature : +40 ± 2 °C
Humidity : 90 – 95 % RH
Duration : 96 hrs

	TYPE PRODUCT SPECIFICATION	NUMBER 110-263	
	TITLE 68POS. Memory Card Connectors based on JEIDA Ver4.1/PCMCIA	PAGE 8 of 13	REVISION D
		AUTHORIZED BY Miao SH	DATE 5/12/09
CLASSIFICATION Unrestricted			

7.6 Moisture Resistance

Moisture resistance shall be carried out in accordance with Test Method 106 of MIL-STD-202. The measurement shall be done after allowing the connector to stand under the following conditions.

1). Test conditions

- Temperature : See Fig. 6.2
- Humidity : See Fig. 6.2
- Number of cycles : 10cycles

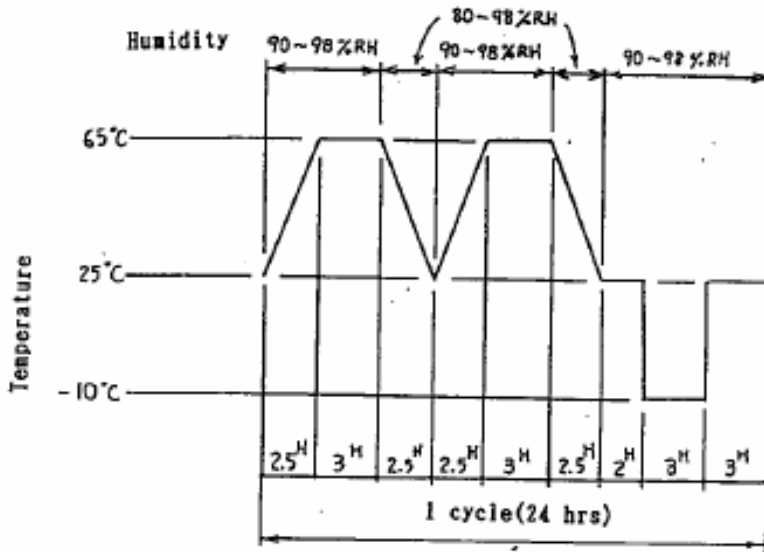

Fig. 7.2 Temperature – Humidity cycle of Moisture Resistance Test

7.7 Thermal shock

Thermal shock shall be carried out in accordance with Test Method 107 of MID-STD-202. After allowing the connector to stand under the following conditions, visual inspection shall be done to check for the absence of crack, crazing, or mechanical defect. After the visual inspection, the specified measurement shall be conducted.

1). Test conditions

- 5 cycles (1 hr / cycle)
- Temperature : -55 °C - +85 °C

7.8 High temperature exposure

High temperature exposure shall be carried out in accordance with Test Method 108 of MIL-STD-202. The measurement shall be done after allowing the connector to stand under the following conditions.

	TYPE	PRODUCT SPECIFICATION		NUMBER	110-263
	TITLE	68POS. Memory Card Connectors based on JEIDA Ver4.1/PCMCIA		PAGE	9 of 13
				REVISION	D
				AUTHORIZED BY	Miao SH
				DATE	5/12/09
				CLASSIFICATION	Unrestricted

1). Test conditions

Temperature: +85°C
Duration : 250 hrs

7.9 Low temperature exposure

Low temperature exposure shall be carried out in accordance with JIS C 0020. The measurement shall be done after allowing the connector to stand under the following conditions.

1). Test conditions

Temperature: -55°C
Duration : 96 hrs

7.10 Hydrogen sulfide (H2S) exposure

Hydrogen sulfide exposure of the mated connector shall be carried out in accordance with JEIDA-38. The measurement shall be done after allowing the connector to stand under the following conditions.

1). Test conditions

Hydrogen sulfide concentration: 3 ppm
Temperature : 40 °C
Humidity : 80% PH
Duration : 96 hrs

7.11 Salt spray

Salt Spray shall be carried out in accordance with Test Method 101 of MIL-STD-202. The measurement shall be done after allowing the connector to stand under the following conditions, lightly washing it with water, then drying it for 24 hours.

1). Test conditions

Salt concentration: 5 %
Temperature : +35 °C
Duration : 48 hrs

7.12 Durability (office environment)

Measurement shall be done before and after the socket connector and header are mated and unmated at the rate of 400 – 2600 cycles / hr.

1). Test conditions

Number of insertion / withdrawal: 10 000 cycles
Temperature : 15 – 35 °C
Humidity : 25 – 85 % PH

7.13 Durability (harsh environment)

Measurement shall be done before and after the following test sequence.

1). Test sequence

Insertion / withdrawal 1,000 cycles *1

	TYPE	PRODUCT SPECIFICATION		NUMBER	110-263
	TITLE	68POS. Memory Card Connectors based on JEIDA Ver4.1/PCMCIA		PAGE	10 of 13
				REVISION	D
				AUTHORIZED BY	Miao SH
				DATE	5/12/09
				CLASSIFICATION	Unrestricted

↓
Moisture resistance 1 cycle *2
↓
Insertion / withdrawal 1,000 cycles (Total 2000 cycles) *1
↓
Moisture resistance 1 cycle (Total 2000 cycles) *2
↓
Insertion / withdrawal 3,000 cycles (Total 5000 cycles) *1
↓
Moisture resistance 1 cycle (Total 3 cycles) *2
↓
Hydrogen sulfide exposure 96hrs *3

*1 : Insertion / Withdrawal speed : 400~600 cycles / hr.

*2 : See Test Method 6.6

*3 : See Test Method 6.10

7.14 Vibration

Mount the connector onto the test table as shown in Fig.6.3, and apply Vibration to the table under the following conditions. The test shall be In accordance with Test Method 204 of MIL-STD-202.

- 1). Test conditions: $\pm 15G$. 10 – 2000 Hz
- 2).Duration : 4 hrs, for each axial direction of 3 dimensions (total 12 hrs)

7.15 Shock

Mount the connector onto the test table as shown in fig.6.3. , and apply vibration to the table under the following conditions. The test shall be In accordance with Test 213 of MIL-STD-202.

- 1). Test conditions : 50G 11ms half wave of sine wave
- 2). Number of shocks : 3 shocks in every axial direction of 3 dimensions (total 18 shocks)

7.16 Total mating / unmating force

Determine the maximum load necessary to mate the socket connector with the Header along the axial direction. Also determine the maximum load to unmate the two in the same way.

- 1). Test conditions
Speed of insertion / withdrawal : 25 mm / min

7.17 Terminal withdrawal force

Maximum load to withdraw the specified gage pin along the axial direction Shall be measured.

- 1). Test conditions
Withdrawal speed : 25 mm / min

	TYPE	PRODUCT SPECIFICATION		NUMBER	110-263
	TITLE	68POS. Memory Card Connectors based on JEIDA Ver4.1/PCMCIA		PAGE	11 of 13
				REVISION	D
				AUTHORIZED BY	Miao SH
				DATE	5/12/09
				CLASSIFICATION	Unrestricted

Pin diameter : $\Phi 0.42 \pm 0.052$ made of tool steel (HRC=50-55)

7.18 Terminal retention force

Terminal retention force shall be determined for both the socket connector and header. Care should be taken during the measurement to secure to secure the bodies of the socket connector and header housings, and to the direction of terminal withdrawal.

Cross-head speed shall be kept at 25 mm / min.

1). Terminal retention force of the socket connector

When a terminal within the housing is withdrawn along the axial direction

While securing the socket housing with a fixture, the values specified

In Table 5.1 shall be satisfied. (See Fig.6.4)

2). Terminal retention force of the header

When a terminal is withdrawn along the axial direction while securing the

Header housing body with a fixture, the values specified in Table 5.1.

Shall be satisfied. (See Fig.6.5)

7.19 Solderability

Conforming to Test Method 208 of MIL-STD-202, the solder tail (solder plated) of the header housing and socket housing shall be dipped into a flux (alpha 100, GX-5, GX-7), for 5 to 10 seconds, then they are dipped into a solder bath (Sn 60, Pb 40) at $230 \pm 5^\circ\text{C}$ for 3 ± 0.5 sec. or (Sn-Ag3.0-Cu0.5) at $260 \pm 5^\circ\text{C}$ for 3 ± 0.5 sec. (for lead free Product.)

After the procedure, observe the Area covered with the solder.

7.20 Solder-heat resistance

Solder-heat resistance of the header and socket connector shall be in accordance With Test Method 210 of MIL-STD-202. Mount the header to the printed wiring board,

And dip the tails projected from the bottom of the board and the solder tails of

The socket connector into a solder bath at $260 \pm 5^\circ\text{C}$ for 10 ± 1 sec.

Observe the condition of the header and socket housings.



TYPE

PRODUCT SPECIFICATION

NUMBER

110-263

TITLE

68POS. Memory Card Connectors based on JEIDA Ver4.1/PCMCIA

PAGE

12 of 13

REVISION

D

AUTHORIZED BY

Miao SH

DATE

5/12/09

CLASSIFICATION

Unrestricted

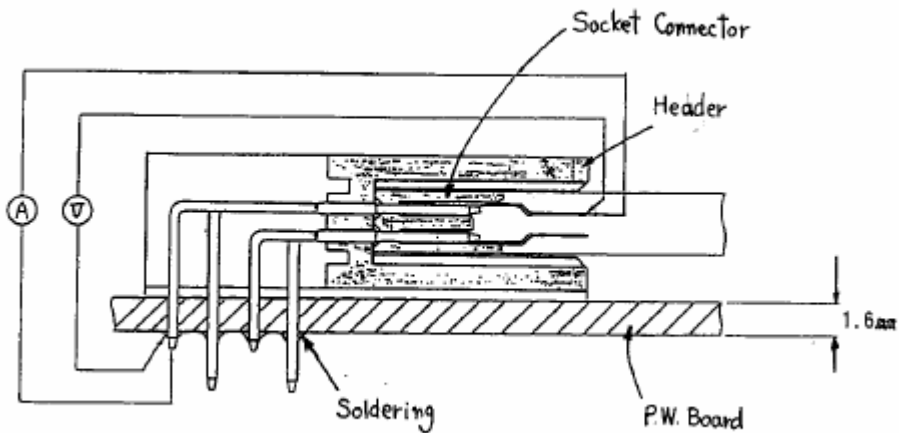

Fig. 6.1 Contact Resistance Measurement (Low Level)

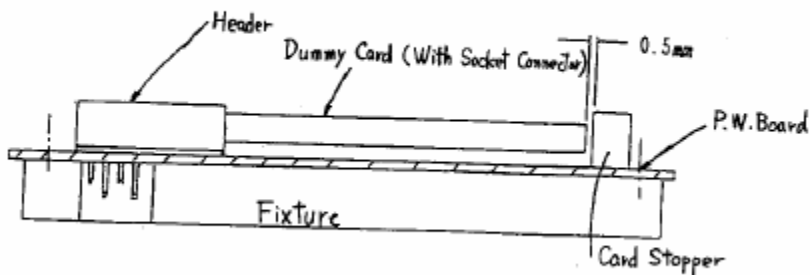

Fig. 6.3 Shock and Vibration



TYPE
PRODUCT SPECIFICATION

NUMBER
110-263

TITLE
68POS. Memory Card Connectors based on JEIDA Ver4.1/PCMCIA

PAGE
13 of 13

REVISION
D

AUTHORIZED BY
Miao SH

DATE
5/12/09

CLASSIFICATION
Unrestricted

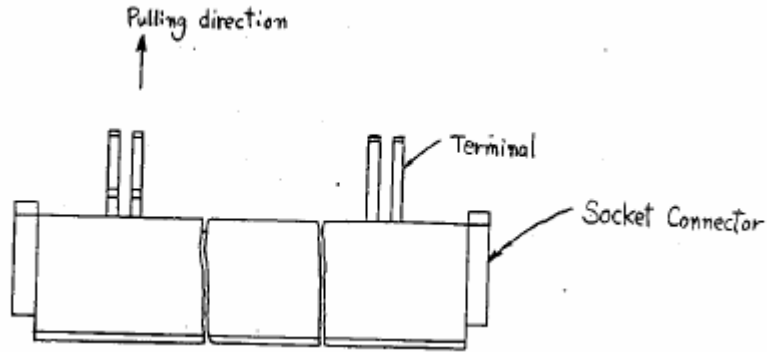

Fig. 6.4 Terminal Retention of Socket Connector

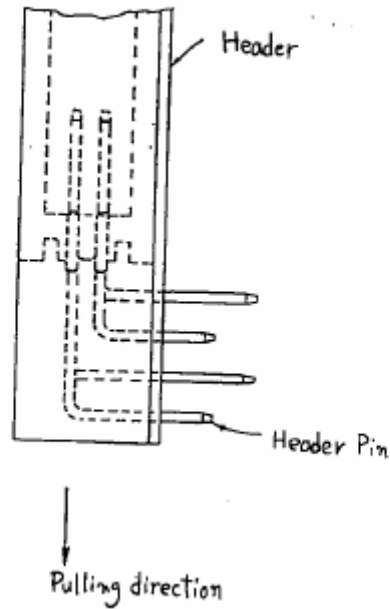

Fig. 6.5 Terminal Retention Force of header

AMEYA360

Components Supply Platform

Authorized Distribution Brand :



Website :

Welcome to visit www.ameya360.com

Contact Us :

➤ Address :

401 Building No.5, JiuGe Business Center, Lane 2301, Yishan Rd
Minhang District, Shanghai , China

➤ Sales :

Direct +86 (21) 6401-6692

Email amall@ameya360.com

QQ 800077892

Skype [ameyasales1](#) [ameyasales2](#)

➤ Customer Service :

Email service@ameya360.com

➤ Partnership :

Tel +86 (21) 64016692-8333

Email mkt@ameya360.com