



Website: www.displaytech.com.hk

LCD Module

Product Specification

Product: DT070ATFT & DT070ATFT-TS
7.0" TFT Display Module (800RGBx480DOTS)

Contents in this document are subject to change without notice. No part of this document may be reproduced or transmitted in any form or by any means, electronic or mechanical, for any purpose, without the express written permission of Displaytech Ltd.

3 November 2011.

1. REVISION RECORD

VERSION	CHANGES	DATE
1.0	Initial revision	21 July 2011
1.1	Added DT070ATFT-TS mechanical drawing on page 5	25 July 2011
1.2	Added "Power Consumption" section and changed the temperature range for -TS version	3 November 2011

Table of Content

1. REVISION RECORD 1

2. Introduction 3

3. General Specifications 3

4. Mechanical Drawing..... 4

5. Interface Description 6

6. Absolute Maximum Ratings 7

7. Electrical Characteristics..... 7

8. Power Consumption 7

9. Display Controller /Power Supply Timing..... 7

10. Backlight specification 8

11. Optical Characteristics..... 8

12. Safety Precaution 11

2. Introduction

DT070ATFT and **DT070ATFT-TS** is a display module that contains a TFT display with a 480 * 800 RGB resolution. The driver used for this project is the Himax **HX8264 + HX8664** or compatible and can display 16.7M colors. The driver is mounted on the glass and the interconnection via FPC including components to drive the display module.

3. General Specifications

Item	Specification	Unit
LCD mode	Transmissive	---
Resolution	800(RGB)	Line
	480	Line
Diagonal Size	7.0	Inch
Overall Size	164.90	mm
	100.00	mm
Active area	154.08	mm
	85.92	mm
Optimum Viewing Direction	12 o'clock	---
Driver IC	Himax HX8264 + HX8664	---
Interface type	RGB 24-bit with TCON	---
Colours	16.7M	---
Operation temperature range	-20~70	°C
Storage temperature range	-30~80	°C

Remarks:

- (1) Recommended mating connector: Hirose FH19SC-50S-0.5SH, FH12S-50S-0.5SH; or Molex 0512965093, 0512965094; or equivalent
- (2) Color tune may be changed slightly by temperature and driving voltage.
- (3) RoHS compliant.

Component Life Cycle

- 1) Storage Life: min. 1 Year
- 2) Operation Life (*1): min. 43 x 10³ h (24hr/day x 7days/week x 52weeks/year x 5years)
(Not include backlight)
- 3) Storage and Operation Life Times are defined for a temperature of +25°C

Notes:

*1. Operation life ends when one of the listed faults occurs:

- The on/off response-times reach 1.5 times of the max. value specified for a new display
- The contrast is reduced to 0.5 of the original contrast value
- Loss of function
- The number of cosmetic defects exceeds the maximum defined

4. Mechanical Drawing

• DT070ATFT

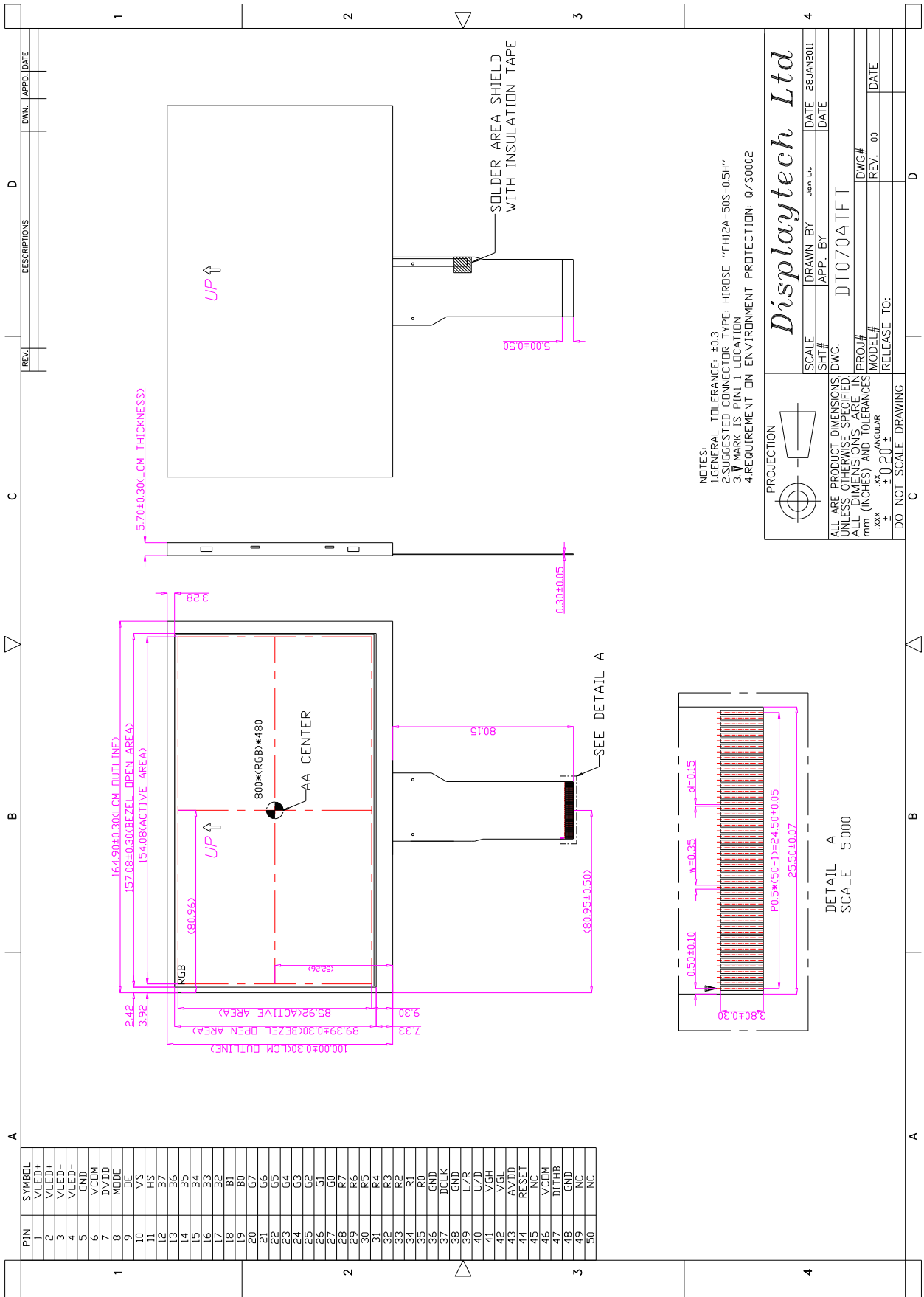

• DT070ATFT-TS

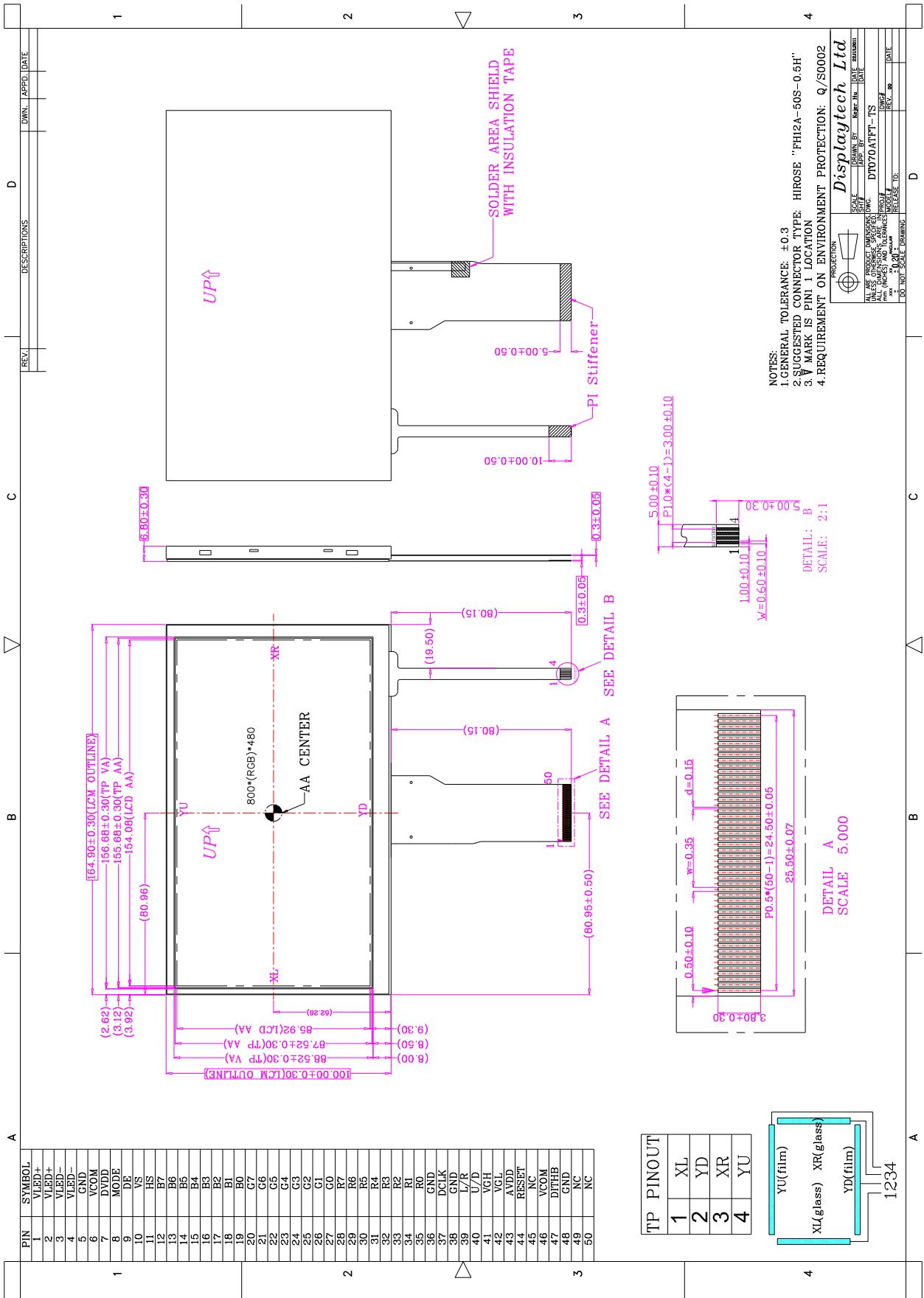

NOTES:
 1. GENERAL TOLERANCE: ±0.3
 2. SUGGESTED CONNECTOR TYPE: HIROSE "PH2A-50S-0.5H"
 3. MARK IS FINI 1 LOCATION
 4. REQUIREMENT ON ENVIRONMENT PROTECTION: Q/S0002

PRODUCTION
 SCALE: 1:1
 DT070ATFT-TS
 Displaytech Ltd
 RELEASE TO: []
 DATE: []

5. Interface Description

Pin no	Symbol	I/O	Description
1~2	VLED+	---	Power for LED backlight (anode)
3~4	VLED-	---	Power for LED backlight (cathode)
5	GND	---	Power ground 0V
6	VCOM	I	Common voltage input
7	DVDD	---	Power for digital circuit
8	MODE	I	DE/SYNC mode select (“H” = DE mode; “L” = SYNC mode)
9	DE	I	Data enable signal, active high to enable data
10	VS	I	Vertical sync input, negative polarity
11	HS	I	Horizontal sync input, negative polarity
12	B7	I	Blue data (MSB)
13~18	B6~B1	I	Blue data
19	B0	I	Blue data (LSB)
20	G7	I	Green data (MSB)
21~26	G6~G1	I	Green data
27	G0	I	Green data (LSB)
28	R7	I	Red data (MSB)
29~34	R6~R1	I	Red data
35	R0	I	Red data (LSB)
36	GND	---	Power ground 0V
37	DCLK	I	Clock for input data
38	GND	---	Power ground 0V
39	L/R	I	Source left or right sequence control
40	U/D	I	Gate up or down scan control
41	VGH	---	Positive power of TFT
42	VGL	---	Negative power of TFT
43	AVDD	---	Analog power supply
44	RESET	I	Global reset pin
45	NC	---	No connection
46	VCOM	I	Common voltage input
47	DITHB	I	Dithering setting. “H” = 6bit resolution, “L” = 8bit resolution
48	GND	---	Power ground 0V
49	NC	---	No connection
50	NC	---	No connection

• Touch Screen Interface (DT070ATFT-TS only)

Pin no	Symbol	I/O	Description
1	XL	O	X+ channel output
2	YD	O	Y+ channel output
3	XR	O	X- channel output
4	YU	O	Y- channel output

6. Absolute Maximum Ratings

(AGND=GND=0V; Ta=25°C)

Item	Symbol	Min.	Max.	Unit
Power voltage	VCC	-0.5	+ 5.0	V
	AVDD	-0.5	13.5	V
	VGH	-0.3	+42	V
	VGL	VGH-42	+0.3	V
Operating Temperature	TOP	-20	+70	°C
Storage Temperature	TST	-30	+80	°C

Note:

- When temperature is below 0°C, the response time of liquid crystal (LC) will be slower and the color of panel will be darker.
- If module driving condition exceeds the absolute maximum ratings, permanent damaged may be resulted. If module is driven within the absolute maximum ratings but exceeded the DC characteristics, mal-function may be resulted.
- VDD/VCC > VSS

7. Electrical Characteristics

DC Characteristics

(AGND=GND=0V; Ta=25°C)

Item	Symbol	Min.	Typ.	Max.	Unit
Digital supply voltage	VCC	---	3.3	---	V
Analog supply voltage	AVDD	---	10.4	---	V
Gate On voltage	VGH	---	16	---	V
Gate Off voltage	VGL	---	-7	---	V
Common electrode driving signal	VCOM	3.5	---	4.5	V
Logic supply voltage	DVDD	(2.8)	3.3	(3.6)	V
Input signal voltage	Low level	VIL	0	---	0.3xDVDD
	High level	VIH	0.7xDVDD	---	DVDD
Output signal voltage	Low level	VOL	---	---	GND+0.4
	High level	VOH	DVDD-0.4	---	---

8. Power Consumption

(GND=VSS=0V; Ta=25°C)

Item	Symbol	Condition	Typ	Max.	Unit
Digital Supply Current	IDVDD	DVDD=3.3	3.22	8.70	mA
Analog Supply Current	IADVDD	AVDD=10.4V	15.69	23.01	mA
Gate On Current	IVGH	VGH=16.0V	0.20	0.22	mA
Gate Off Current	IVGL	VGL=-7.0V	0.20	0.22	mA
Power Consumption	Panel & Gamma	---	177.67	254.65	mW
	Backlight	---	1.152	1.267	W
	Total	---	1.330	1.522	W

9. Display Controller /Power Supply Timing

See Display Controller Specification: Himax HX8264 + HX8664

10. Backlight specification

(Vcc=3.3V, Vss=0V, Ta=25°C)

Item	Symbol	Min	Typ	Max	Unit	Note
Supply voltage	Vf	---	9.6	---	V	18 LEDs
Forward current	If	---	20	25	mA	
Backlight power consumption	WBL	---	1.152	1.267	W	

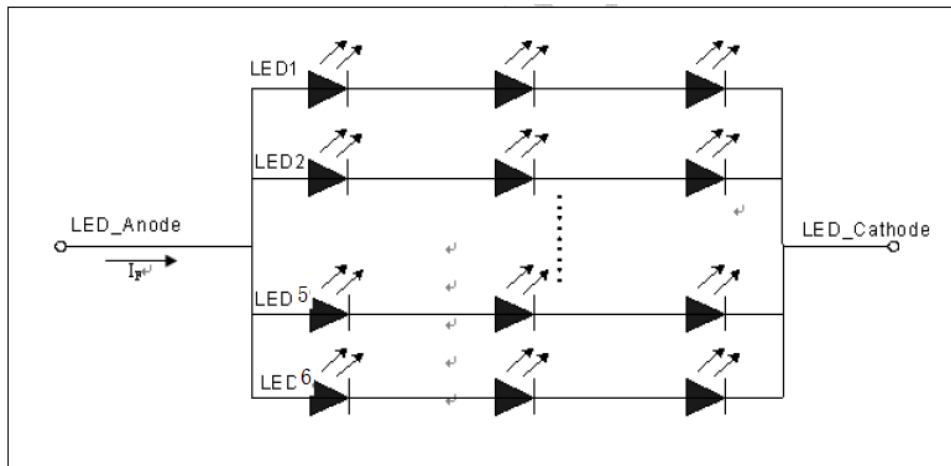

Notes:

- 1) The LED's driving condition is defined for each LED backlight (3 LEDs in series per line, and 6 lines per module).
- 2) In operation, constant forward current should be supplied, the forward voltage is for reference only.

11. Optical Characteristics

(Vcc=3.3V, Vss=0V, Ta=25°C)

Item	Symbol	Condition	Min	Typ	Max	Unit	Note
Luminance	L	$\theta=0^\circ$	200	250	---	cd/m ²	1, 2
Uniformity	U	$\Phi=0^\circ$	---	75	---	%	1, 2
Viewing Angle	θT	$Cr \geq 10$	50	60	---	deg	3
	θB		60	70	---		
	θL		60	70	---		
	θR		60	70	---		
Contrast ratio	Cr	$\theta=0^\circ$	400	500	---	---	1, 4
Response Time	Tr		---	25	---	ms	1, 5
	CIE (x,y) Chromaticity	White	x	0.267	0.317	0.367	---
y			0.284	0.334	0.384		
Red		x	0.567	0.617	0.667		
		y	0.305	0.355	0.405		
Green		x	0.289	0.339	0.389		
		y	0.483	0.533	0.583		
Blue		x	0.092	0.142	0.192		
		y	0.049	0.099	0.149		
NTSC Ratio	S	$\theta=0^\circ$	---	50	---	%	

Note 1: The data are measured after LEDs are turned on for 5 minutes. LCM displays full white.
The brightness is the average value of 9 measured spots. Measurement equipment PR-705 (Φ8mm)

Measuring condition:

- Measuring surroundings: Dark room.
- Measuring temperature: $T_a=25^{\circ}\text{C}$.
- Adjust operating voltage to get optimum contrast at the center of the display.

Measured value at the center point of LCD panel after more than 5 minutes while backlight turning on.

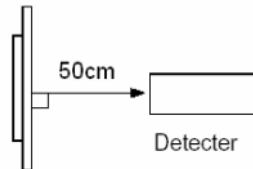

Note 2: The luminance uniformity is calculated by using following formula.

$$L = L(\text{Min.}) / L(\text{Max.}) \times 100 (\%)$$

$L(\text{Max.})$ = Maximum brightness in 9 measured spots

$L(\text{Min.})$ = Minimum brightness in 9 measured spots.

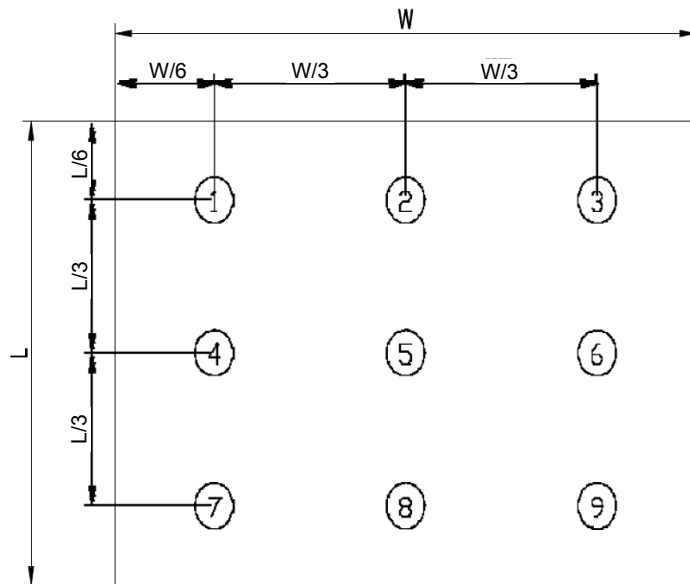

Measurement equipment PR-705 (Φ8mm)

Note 3: The definition of viewing angle:

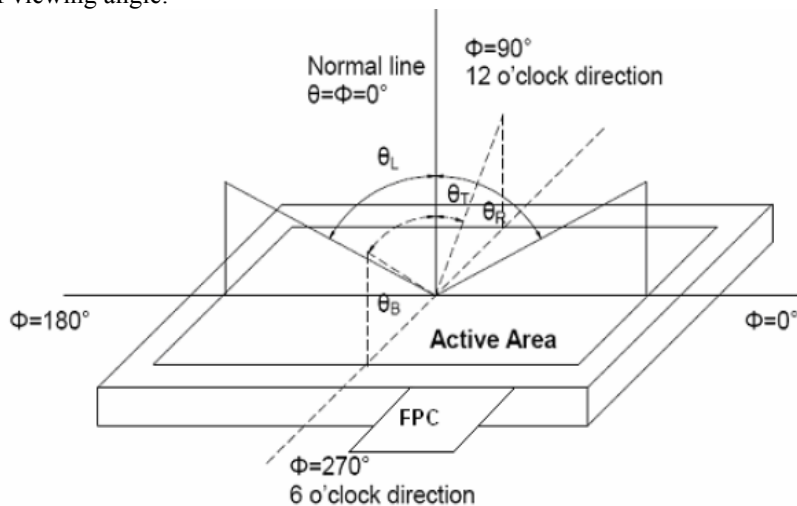

Note 4: The definition of contrast ratio (Test LCM using PR-705):

$$\text{Contrast Ratio (CR)} = \frac{\text{Luminance When LCD is at "White" state}}{\text{Luminance When LCD is at "Black" state}}$$

(Contrast Ratio is measured in optimum common electrode voltage)

Note 5: Definition of Response time. (Test LCD using DMS501):

The output signals of photo detector are measured when the input signals are changed from "black" to "white" (falling time) and from "white" to "black" (rising time), respectively.

The response time is defined as the time interval between the 10% and 90% of amplitudes. Refer to figure as below.

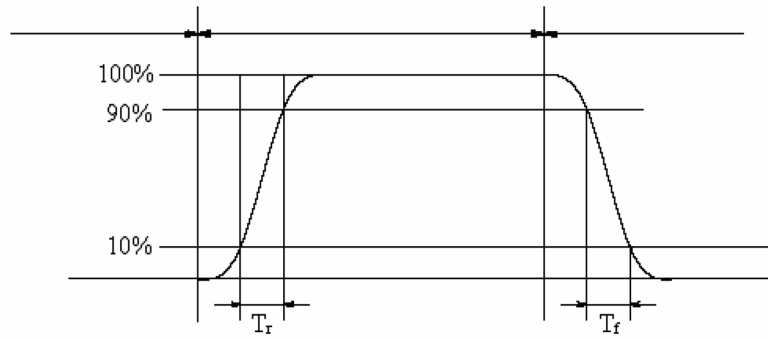

The definition of response time

Note 6: Definition of Color of CIE Coordinate and NTSC Ratio.

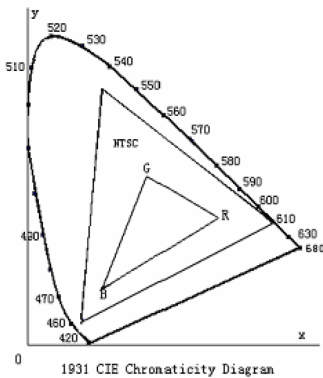

Color gamut:

$$S = \frac{\text{area of RGB triangle}}{\text{area of NTSC triangle}} \times 100\%$$

12. Safety Precaution

Handling precautions:

- This device is susceptible to Electro-Static Discharge (ESD) damage. Observe Anti-Static precautions.

Power supply precautions:

- Identify and, at all times, observe absolute maximum ratings for both logic and LC drivers. Note that there is some variance between models.
- Prevent the application of reverse polarity to VCC and GND, however briefly.
- Use a clean power source free from transients. Power up conditions are occasionally “jolting” and may exceed the maximum ratings of the modules.
- The VCC power of the module should also supply the power to all devices that may access the display. Don't allow the data bus to be driven when the logic supply to the module is turned off.

Operating precautions:

- DO NOT plug or unplug the module when the system is powered up.
- Minimize the cable length between the module and host MPU.
- Operate the module within the limits of the modules temperature specifications.

Mechanical/Environmental precautions:

- Improper soldering is the major cause of module difficulty. Use of flux cleaner is not recommended as they may seep under the elastomeric connection and cause display failure.
- Mount the module so that it is free from torque and mechanical stress.
- Surface of the LCD panel should not be touched or scratched. The display front surface is an easily scratched, plastic polarizer. Avoid contact and clean only when necessary with soft, absorbent cotton dampened with petroleum benzene.
- Always employ anti-static procedure while handling the module.
- Prevent moisture build-up upon the module and observe the environmental constraints for storage temperature and humidity.
- Do not store in direct sunlight
- If leakage of the liquid crystal material should occur, avoid contact with this material, particularly ingestion. If the body or clothing becomes contaminated by the liquid crystal material, wash thoroughly with water and soap

AMEYA360

Components Supply Platform

Authorized Distribution Brand :



Website :

Welcome to visit www.ameya360.com

Contact Us :

➤ Address :

401 Building No.5, JiuGe Business Center, Lane 2301, Yishan Rd
Minhang District, Shanghai , China

➤ Sales :

Direct +86 (21) 6401-6692

Email amall@ameya360.com

QQ 800077892

Skype [ameyasales1](#) [ameyasales2](#)

➤ Customer Service :

Email service@ameya360.com

➤ Partnership :

Tel +86 (21) 64016692-8333

Email mkt@ameya360.com