

# 1000 Series Miniature Slide Switches

## Features/Benefits

- Variety of actuators and terminations
- Panel mount tabs available
- Epoxy terminal seal—compatible with bottom-wash cleaning
- RoHS compliant



Models Available

## Typical Applications

- Test & measurement equipment
- Telecommunications
- Computer & peripherals

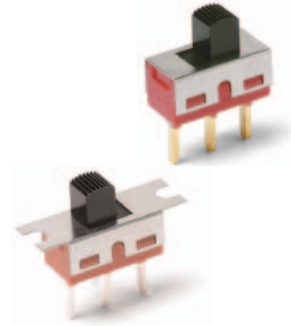

## Specifications

CONTACT RATING: B contact material: 0.4 VA max. @ 20 V AC or DC max. Q contact material: 6 AMPS @ 120 V AC or 28 V DC, 3 AMPS @ 250 V AC. See page I-15 for additional ratings.

ELECTRICAL LIFE: 100,000 make-and-break cycles at full load on models with B, K or P contact material; 40,000 cycles on models with G, Q, L, M, S or R contact material.

CONTACT RESISTANCE: Below 10 m Ω typ. initial @ 2-4 V DC, 100 mA, for both silver and gold plated contacts.

INSULATION RESISTANCE: 10<sup>9</sup> Ω min.

DIELECTRIC STRENGTH: 1,000 Vrms min. @ sea level.

OPERATING TEMPERATURE: -30°C to 65°C

SOLDERABILITY: Per MIL-STD-202F method 208D, or EIA RS-186E method 9 (1 hour steam aging).

## Materials

CASE: diallyl phthalate (DAP), (UL 94V-0).

ACTUATOR: Nylon, black, standard.

HOUSING: Stainless steel.

SWITCH SUPPORT: Brass or steel, matte-tin plated.

END CONTACTS: B contact material: Copper alloy, with gold plate over nickel plate. Q contact material: Coin silver, silver plated. See page I-16 for additional contact materials.

CENTER CONTACT & ALL TERMINALS: B contact material: Copper alloy, with gold plate over nickel plate. Q contact material: Copper alloy, silver plated. See page I-16 for additional contact materials.

TERMINAL SEAL: Epoxy. Refer to Soldering and Cleaning in Technical Data chapter

**NOTE:** Any models supplied with Q, B, G, P, S or R contact material are RoHS compliant.

**NOTE:** Specifications and materials listed above are for switches with standard options.

For information on specific and custom switches, consult Customer Service Center.

## Build-A-Switch

To order, simply select desired option from each category and place in the appropriate box. Available options are shown and described on pages I-12 through I-16. For additional options not shown in catalog, consult Customer Service Center. All models have epoxy terminal seal and are compatible with all “bottom-wash” PCB cleaning methods.

<p><b>Switch Function</b></p> <p><b>1101</b> SP On-None-On  <b>1103</b> SP On-Off-On  <b>1108</b> SP Mom-None-On  <b>1201</b> DP On-None-On  <b>1203</b> DP On-Off-On</p> <p><b>Mounting Style</b></p> <p><b>M2</b> PC mount without tabs  <b>M1</b> Panel mount with tabs</p> <p><b>Actuator</b></p> <p><b>S3</b> .200" high  <b>S1</b> .040" high  <b>S2</b> .140" high  <b>S4</b> .285" high  <b>S5</b> .370" high  <b>S6</b> .485" high  <b>T3</b> .200" high</p> <p><b>Terminations</b></p> <p><b>A</b> Right angle, PC thru-hole  <b>C</b> PC Thru-hole  <b>AV2</b> Vertical right angle, PC thru-hole  <b>Z</b> Solder lug  <b>V3</b> V-bracket  <b>V4</b> V-bracket  <b>W</b> .750" long, wire wrap  <b>Z3</b> Quick connect</p>	<p><b>Contact Material</b></p> <p><b>B</b> Gold  <b>Q</b> Silver  <b>G</b> Gold over silver  <b>P</b> Gold, matte-tin  <b>S</b> Silver, matte-tin  <b>R</b> Gold over silver, matte-tin</p> <p><b>Seal</b></p> <p><b>E</b> Epoxy  <b>D</b> No epoxy seal  <b>I</b> Epoxy potted base</p> <p><b>Actuator Color</b></p> <p><b>2</b> Black  <b>1</b> White  <b>3</b> Red</p>
--	---



Dimensions are shown: Inches (mm)  
Specifications and dimensions subject to change



Slide

# 1000 Series Miniature Slide Switches

## SWITCH FUNCTION

NO. POLES	MODEL NO.	SWITCH FUNCTION			CONNECTED TERMINALS			SCHEMATIC
		POS. 1	POS. 2	POS. 3	POS. 1	POS. 2	POS. 3	
SP	1101	ON	NONE	ON	1-2	N/A	2-3	 SPDT
	1103	ON	OFF	ON		OPEN		
	1108	MOM.	NONE	ON		N/A		
<b>SPDT</b>  Part number shown: 1101M2S3CQE2 Terminal Nos. For Reference Only								
DP	1201	ON	NONE	ON	2-1,5-4	OPEN	2-3,5-6	 DPDT
	1203	ON	OFF	ON				
<b>DPDT</b>  Part number shown: 1201M2S3CQE2 Terminal Nos. For Reference Only								

MOM. = Momentary

All models with all options when ordered with G, Q, S or R contact material.

## MOUNTING STYLE

**M2** PC MOUNTING WITHOUT TABS

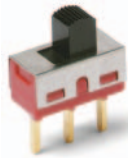

**NOTE:** Available with A, AV2, C, V3, V4, W terminations only.

**M1** PANEL MOUNTING WITH TABS

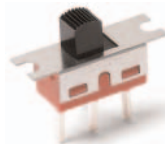

**NOTE:** Available with C, W, Z, Z3 terminations only. No mounting hardware supplied.

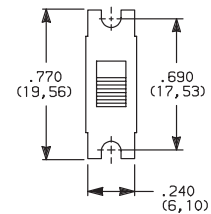

### PANEL MOUNTING

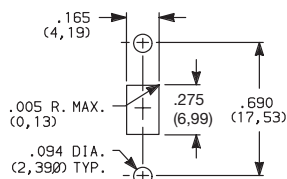

All actuators except T3.  
Single pole

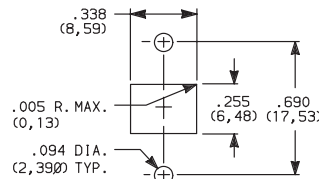

For T3 actuator only.  
Double pole



Dimensions are shown: Inch (mm)  
Specifications and dimensions subject to change



Slide

# 1000 Series Miniature Slide Switches

## ACTUATOR

**S3** .200" HIGH

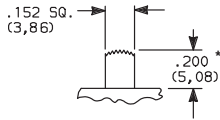

**S2** .140" HIGH

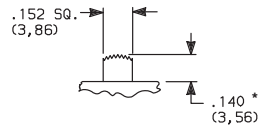

110X models only.

**S1** .040" HIGH

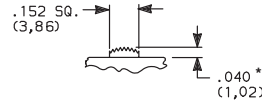

120X models only.

**S4** .285" HIGH

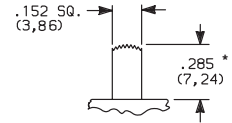

**S5** .370" HIGH

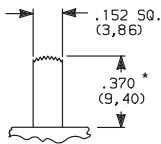

**S6** .485" HIGH

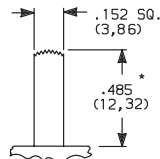

**T3** .200" HIGH

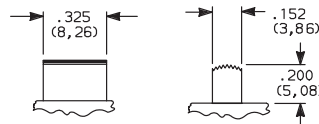

120X models only.

OPTION CODE	ACTUATOR COLOR
2	BLACK
1	WHITE
3	RED
7	BLUE
9	GRAY

Other colors available, consult Customer Service Center.

\* Subtract .014 (0,36) from actuator height, all models with A, AV2 - 2 pole, V3, V4 terminations.

## TERMINATIONS

**Z** SOLDER LUG

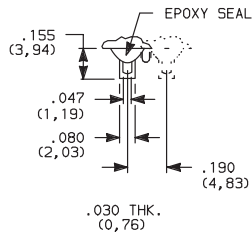

Not available with P, S or R contact materials.

SPDT & DPDT

**C** PC THRU-HOLE

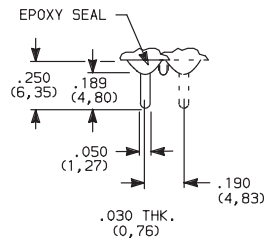

PC MOUNTING

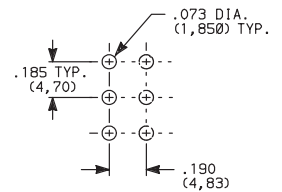

SPDT & DPDT

**Z3** QUICK CONNECT

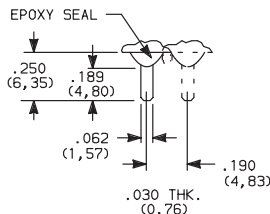

Not available with P, S or R contact materials. Mating quick connector available; order part number 530100000, page I-16.

SPDT & DPDT

**W** WIRE WRAP

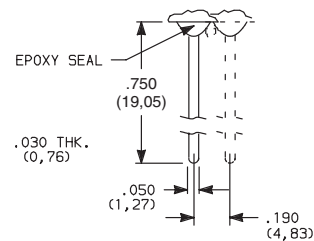

SPDT & DPDT



Third Angle Projection

Dimensions are shown: Inches (mm)  
Specifications and dimensions subject to change



Slide

# 1000 Series Miniature Slide Switches

## TERMINATIONS

### A RIGHT ANGLE, PC THRU-HOLE



**1101M2S3ABE2**  
Horizontal Actuation  
**SPDT**

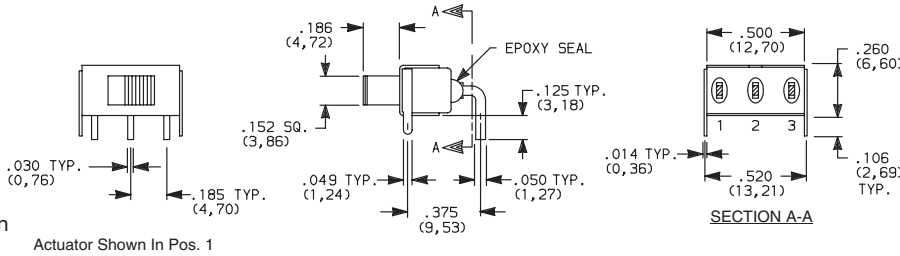

Not available with M1 mounting style, I seal option.  
Terminal bend radii and lead-in manufacturing option.

### A RIGHT ANGLE, PC THRU-HOLE

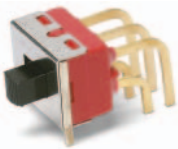

**1201M2S3ABE2**  
Horizontal Actuation  
**DPDT**

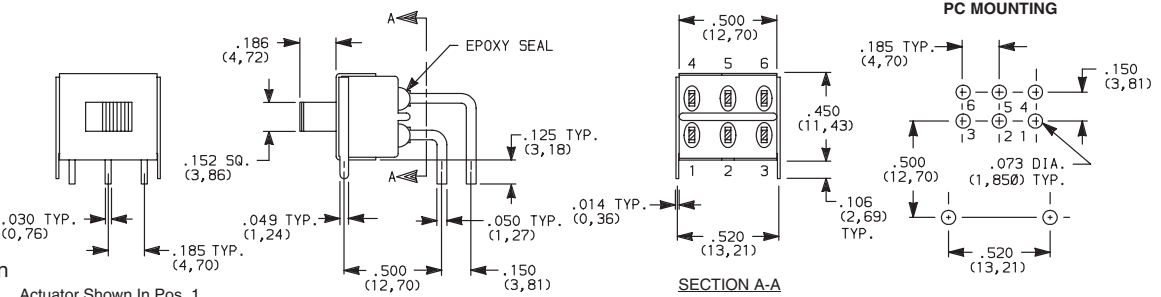

Not available with M1 mounting style, I seal option.  
Terminal bend radii and lead-in manufacturing option.

### AV2 VERTICAL RIGHT ANGLE, PC THRU-HOLE, .150" PITCH



**1101M2S3AV2BE2**  
Vertical Actuation  
**SPDT**

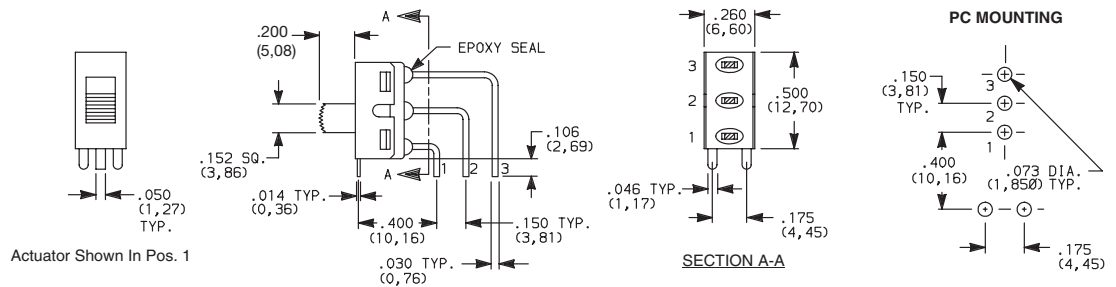

Not available with M1 mounting style, I seal option.  
Terminal bend radii and lead-in manufacturing option.



Third Angle  
Projection

Dimensions are shown: Inch (mm)  
Specifications and dimensions subject to change

# 1000 Series Miniature Slide Switches

## TERMINATIONS

**AV2** VERTICAL RIGHT ANGLE, PC THRU-HOLE,  
.150" PITCH

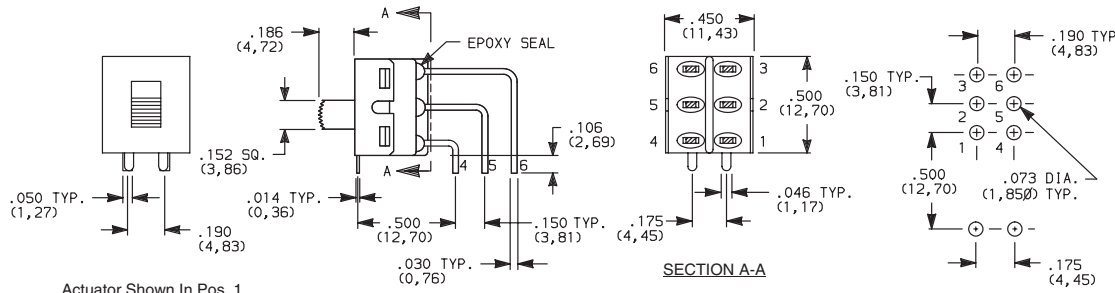

Actuator Shown In Pos. 1



1201M2S3AV2BE2  
Vertical Actuation  
DPDT

Not available with M1 mounting style, I seal option.  
Terminal bend radii and lead-in manufacturing option.

**V3, V4** VERTICAL MOUNT,  
V-BRACKET

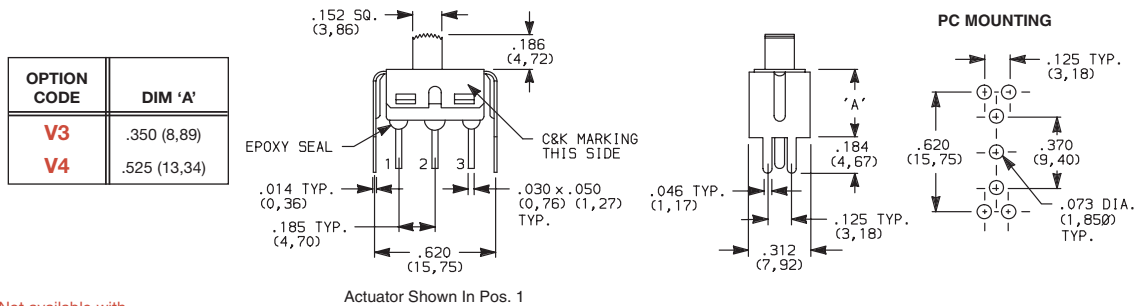

Actuator Shown In Pos. 1

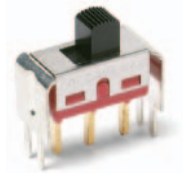

1101M2S3\_BE2  
SPDT

Not available with  
M1 mounting style and I seal.

**V3, V4** VERTICAL MOUNT,  
V-BRACKET

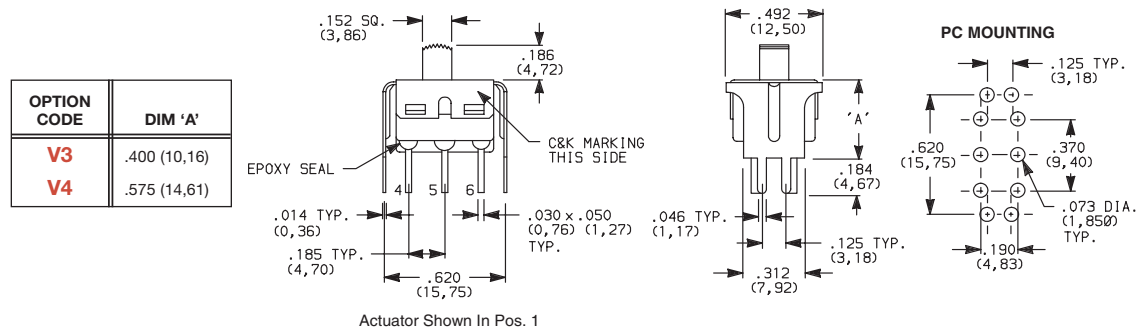

Actuator Shown In Pos. 1

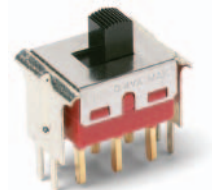

1201M2S3\_BE2  
DPDT

Not available with  
M1 mounting style and I seal.



Dimensions are shown: Inches (mm)  
Specifications and dimensions subject to change



# 1000 Series Miniature Slide Switches

## CONTACT MATERIAL

OPTION CODE	CONTACT MATERIAL	TERMINAL PLATING	RATINGS	
<b>B</b>	GOLD <sup>1</sup>	GOLD <sup>3</sup>	LOW LEVEL/ DRY CIRCUIT	0.4 VA MAX. @ 20 V AC OR DC MAX.
<b>P</b>		MATTE-TIN <sup>6</sup>		
<b>Q</b>	SILVER <sup>4,5</sup>	GOLD <sup>3</sup>	POWER	6 AMPS @ 120 V AC OR 28 V DC; 3 AMPS @ 250 V AC.
<b>S</b>		MATTE-TIN <sup>6</sup>		
<b>G</b>	GOLD OVER SILVER <sup>2,3</sup>	GOLD <sup>3</sup>	LOW LEVEL/DRY CIRCUIT OR POWER	0.4 VA MAX @ 20 V AC OR DC MAX OR 6 AMPS @ 120 V AC OR 0.4 MAX. 28 V DC; 3 AMPS @ 250 V AC.
<b>R</b>		MATTE-TIN <sup>6</sup>		

\* Note: See Technical Data section of this catalog for RoHS compliant and compatible definitions and specifications.

<sup>1</sup> CONTACTS & TERMINALS: Copper alloy, with gold plate over nickel plate.

<sup>2</sup> END CONTACTS: Coin silver, with gold plate over nickel plate.

<sup>3</sup> CENTER CONTACTS & ALL TERMINALS: Copper alloy, with gold plate over nickel plate.

<sup>4</sup> END CONTACTS: Coin silver, silver plated.

<sup>5</sup> CENTER CONTACT & ALL TERMINALS: Copper alloy, silver plated.

<sup>6</sup> TERMINALS: Copper alloy, with matte-tin over nickel plate.

All models **CALUS** with all options when ordered with G, Q, S or R contact material.

B contact material standard with all terminations except C, Z, Z3.

Q contact material standard with C, Z, Z3 terminations.

**P, S or R contact materials not available with Z, Z3 terminations.**

**NOTE:** Any models supplied with Q, B, G, P, S or R contact material are RoHS compliant.

## SEAL

**E** EPOXY SEAL

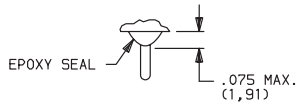

**D** NO EPOXY SEAL

**I** EPOXY POTTED BASE

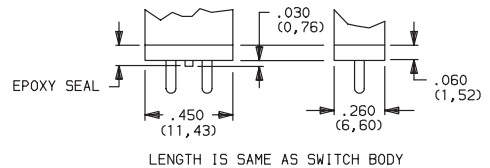

**NOTE:** Available with C, W, W3, Z, Z3 terminations only.

## AVAILABLE HARDWARE

Fits Z3 Termination  
female connector



PART NO.

**530100000**

Available in loose pieces.



Third Angle  
Projection

Dimensions are shown: Inch (mm)  
Specifications and dimensions subject to change

**C&K**

# AMEYA360

Components Supply Platform

Authorized Distribution Brand :



Website :

Welcome to visit [www.ameya360.com](http://www.ameya360.com)

Contact Us :

➤ Address :

401 Building No.5, JiuGe Business Center, Lane 2301, Yishan Rd  
Minhang District, Shanghai , China

➤ Sales :

Direct +86 (21) 6401-6692

Email [amall@ameya360.com](mailto:amall@ameya360.com)

QQ 800077892

Skype ameyasales1 ameyasales2

➤ Customer Service :

Email [service@ameya360.com](mailto:service@ameya360.com)

➤ Partnership :

Tel +86 (21) 64016692-8333

Email [mkt@ameya360.com](mailto:mkt@ameya360.com)