

9-Mbit (256K x 36/512K x 18) Flow-Through SRAM with NoBL™ Architecture

Features

- **No Bus Latency™ (NoBL™) architecture eliminates dead cycles between write and read cycles**
- **Can support up to 133-MHz bus operations with zero wait states**
 - Data is transferred on every clock
- **Pin compatible and functionally equivalent to ZBT™ devices**
- **Internally self-timed output buffer control to eliminate the need to use OE**
- **Registered inputs for flow-through operation**
- **Byte Write capability**
- **3.3V/2.5V I/O power supply (V_{DDQ})**
- **Fast clock-to-output times**
 - 6.5 ns (for 133-MHz device)
- **Clock Enable (CEN) pin to enable clock and suspend operation**
- **Synchronous self-timed writes**
- **Asynchronous Output Enable**
- **Available in JEDEC-standard and lead-free 100-Pin TQFP, lead-free and non lead-free 119-Ball BGA package and 165-Ball FBGA package**
- **Three chip enables for simple depth expansion.**
- **Automatic Power-down feature available using ZZ mode or CE deselect**
- **IEEE 1149.1 JTAG-Compatible Boundary Scan**
- **Burst Capability—linear or interleaved burst order**
- **Low standby power**

Functional Description^[1]

The CY7C1355C/CY7C1357C is a 3.3V, 256K x 36/512K x 18 Synchronous Flow-through Burst SRAM designed specifically to support unlimited true back-to-back Read/Write operations without the insertion of wait states. The CY7C1355C/CY7C1357C is equipped with the advanced No Bus Latency (NoBL) logic required to enable consecutive Read/Write operations with data being transferred on every clock cycle. This feature dramatically improves the throughput of data through the SRAM, especially in systems that require frequent Write-Read transitions.

All synchronous inputs pass through input registers controlled by the rising edge of the clock. The clock input is qualified by the Clock Enable ($\overline{\text{CEN}}$) signal, which when deasserted suspends operation and extends the previous clock cycle. Maximum access delay from the clock rise is 6.5 ns (133-MHz device).

Write operations are controlled by the two or four Byte Write Select ($\overline{\text{BW}}_X$) and a Write Enable ($\overline{\text{WE}}$) input. All writes are conducted with on-chip synchronous self-timed write circuitry.

Three synchronous Chip Enables ($\overline{\text{CE}}_1$, CE_2 , $\overline{\text{CE}}_3$) and an asynchronous Output Enable ($\overline{\text{OE}}$) provide for easy bank selection and output tri-state control. In order to avoid bus contention, the output drivers are synchronously tri-stated during the data portion of a write sequence.

Selection Guide

	133 MHz	100 MHz	Unit
Maximum Access Time	6.5	7.5	ns
Maximum Operating Current	250	180	mA
Maximum CMOS Standby Current	40	40	mA

Note:

1. For best-practices recommendations, please refer to the Cypress application note *System Design Guidelines* on www.cypress.com.

Logic Block Diagram – CY7C1355C (256K x 36)

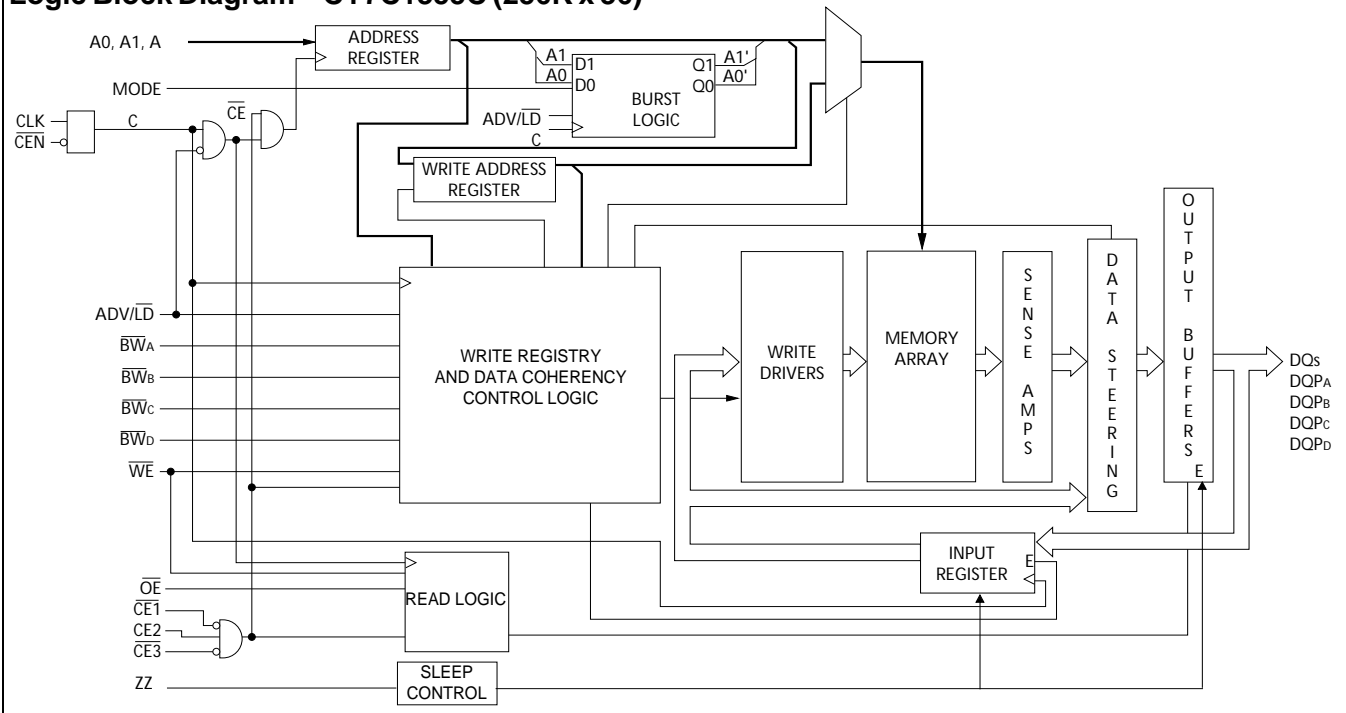

Logic Block Diagram – CY7C1357C (512K x 18)

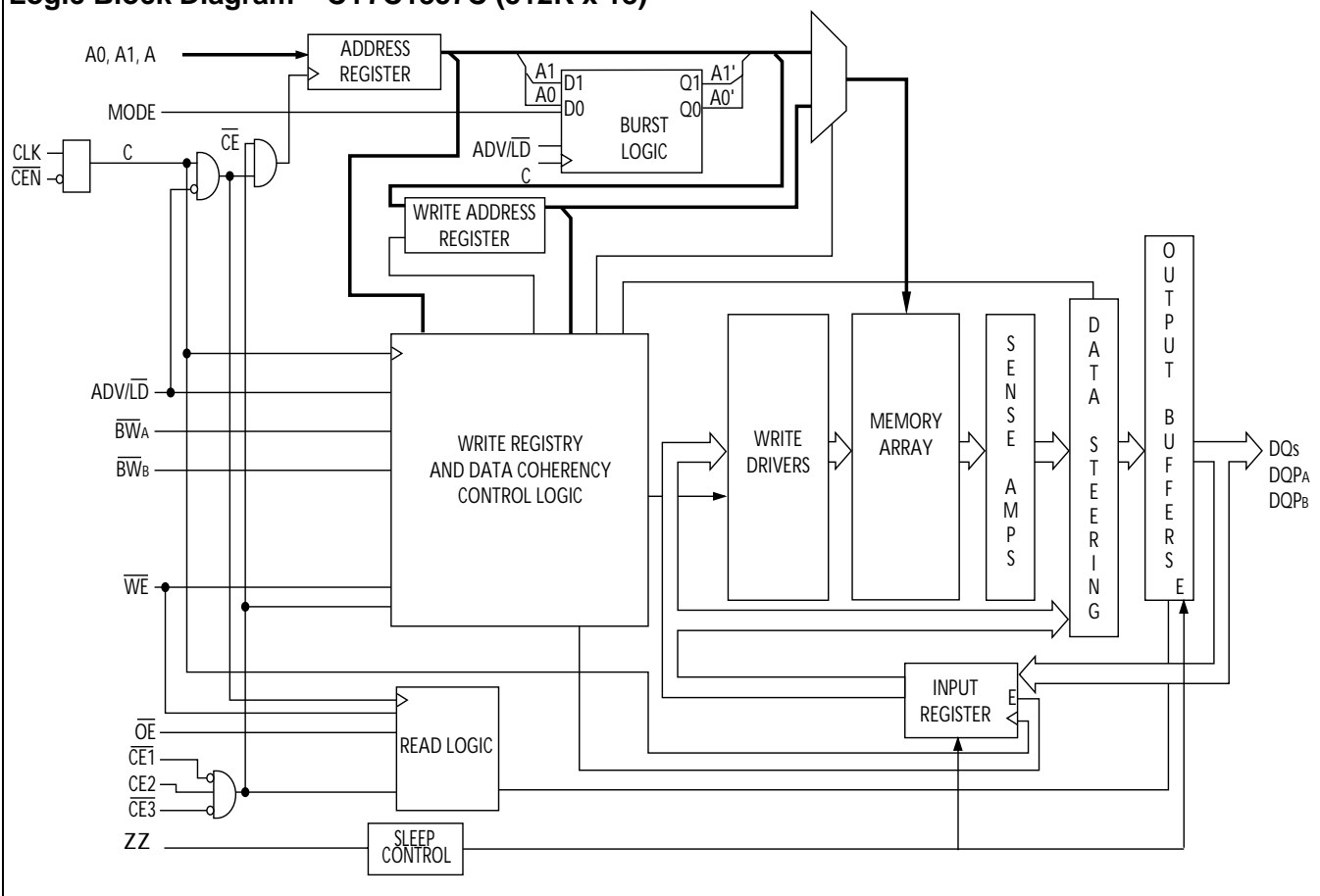

Pin Configurations (continued)

100-Pin TQFP Pinout

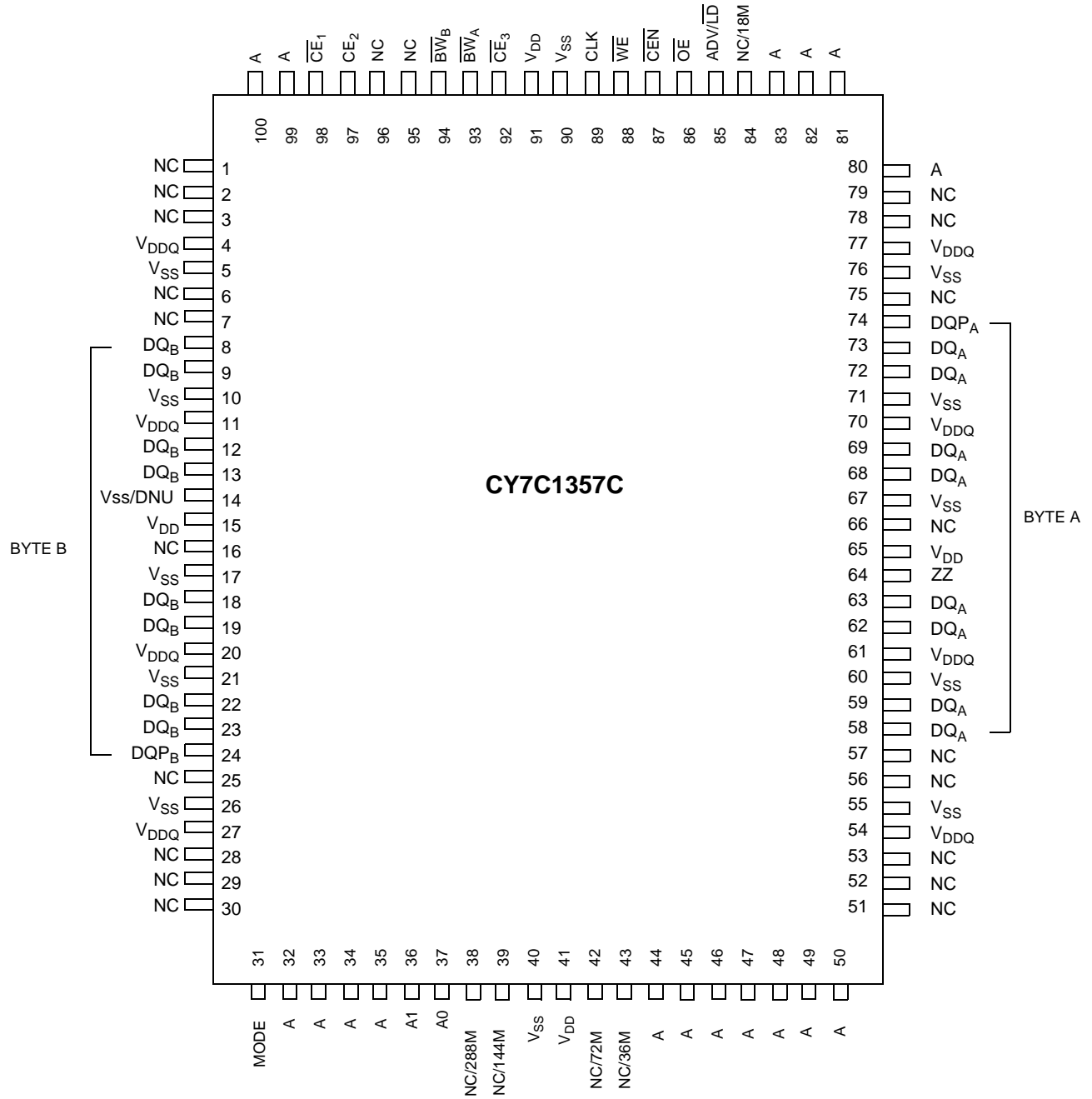

Pin Configurations (continued)

119-Ball BGA Pinout (3 Chip Enables with JTAG)
CY7C1355C (256K x 36)

	1	2	3	4	5	6	7
A	V _{DDQ}	A	A	NC/18M	A	A	V _{DDQ}
B	NC/576M	CE ₂	A	ADV/LD	A	\overline{CE}_3	NC
C	NC/1G	A	A	V _{DD}	A	A	NC
D	DQ _C	DQP _C	V _{SS}	NC	V _{SS}	DQP _B	DQ _B
E	DQ _C	DQ _C	V _{SS}	\overline{CE}_1	V _{SS}	DQ _B	DQ _B
F	V _{DDQ}	DQ _C	V _{SS}	\overline{OE}	V _{SS}	DQ _B	V _{DDQ}
G	DQ _C	DQ _C	\overline{BW}_C	A	\overline{BW}_B	DQ _B	DQ _B
H	DQ _C	DQ _C	V _{SS}	\overline{WE}	V _{SS}	DQ _B	DQ _B
J	V _{DDQ}	V _{DD}	NC	V _{DD}	NC	V _{DD}	V _{DDQ}
K	DQ _D	DQ _D	V _{SS}	CLK	V _{SS}	DQ _A	DQ _A
L	DQ _D	DQ _D	\overline{BW}_D	NC	\overline{BW}_A	DQ _A	DQ _A
M	V _{DDQ}	DQ _D	V _{SS}	\overline{CEN}	V _{SS}	DQ _A	V _{DDQ}
N	DQ _D	DQ _D	V _{SS}	A1	V _{SS}	DQ _A	DQ _A
P	DQ _D	DQP _D	V _{SS}	A0	V _{SS}	DQP _A	DQ _A
R	NC/144M	A	MODE	V _{DD}	NC	A	NC/288M
T	NC	NC/72M	A	A	A	NC/36M	ZZ
U	V _{DDQ}	TMS	TDI	TCK	TDO	NC	V _{DDQ}

CY7C1357C (512K x 18)

	1	2	3	4	5	6	7
A	V _{DDQ}	A	A	NC/18M	A	A	V _{DDQ}
B	NC/576M	CE ₂	A	ADV/LD	A	\overline{CE}_3	NC
C	NC/1G	A	A	V _{DD}	A	A	NC
D	DQ _B	NC	V _{SS}	NC	V _{SS}	DQP _A	NC
E	NC	DQ _B	V _{SS}	\overline{CE}_1	V _{SS}	NC	DQ _A
F	V _{DDQ}	NC	V _{SS}	\overline{OE}	V _{SS}	DQ _A	V _{DDQ}
G	NC	DQ _B	\overline{BW}_B	A	V _{SS}	NC	DQ _A
H	DQ _B	NC	V _{SS}	\overline{WE}	V _{SS}	DQ _A	NC
J	V _{DDQ}	V _{DD}	NC	V _{DD}	NC	V _{DD}	V _{DDQ}
K	NC	DQ _B	V _{SS}	CLK	V _{SS}	NC	DQ _A
L	DQ _B	NC	V _{SS}	NC	\overline{BW}_A	DQ _A	NC
M	V _{DDQ}	DQ _B	V _{SS}	\overline{CEN}	V _{SS}	NC	V _{DDQ}
N	DQ _B	NC	V _{SS}	A1	V _{SS}	DQ _A	NC
P	NC	DQP _B	V _{SS}	A0	V _{SS}	NC	DQ _A
R	NC/144M	A	MODE	V _{DD}	NC	A	NC/288M
T	NC/72M	A	A	NC/36M	A	A	ZZ
U	V _{DDQ}	TMS	TDI	TCK	TDO	NC	V _{DDQ}

Pin Configurations (continued)

165-Ball FBGA Pinout (3 Chip enable with JTAG)
CY7C1355C (256K x 36)

	1	2	3	4	5	6	7	8	9	10	11
A	NC/576M	A	\overline{CE}_1	\overline{BW}_C	\overline{BW}_B	\overline{CE}_3	\overline{CEN}	ADV/LD	A	A	NC
B	NC/1G	A	CE2	\overline{BW}_D	\overline{BW}_A	CLK	\overline{WE}	\overline{OE}	NC/18M	A	NC
C	DQP _C	NC	V _{DDQ}	V _{SS}	V _{SS}	V _{SS}	V _{SS}	V _{SS}	V _{DDQ}	NC	DQP _B
D	DQ _C	DQ _C	V _{DDQ}	V _{DD}	V _{SS}	V _{SS}	V _{SS}	V _{DD}	V _{DDQ}	DQ _B	DQ _B
E	DQ _C	DQ _C	V _{DDQ}	V _{DD}	V _{SS}	V _{SS}	V _{SS}	V _{DD}	V _{DDQ}	DQ _B	DQ _B
F	DQ _C	DQ _C	V _{DDQ}	V _{DD}	V _{SS}	V _{SS}	V _{SS}	V _{DD}	V _{DDQ}	DQ _B	DQ _B
G	DQ _C	DQ _C	V _{DDQ}	V _{DD}	V _{SS}	V _{SS}	V _{SS}	V _{DD}	V _{DDQ}	DQ _B	DQ _B
H	NC	NC	NC	V _{DD}	V _{SS}	V _{SS}	V _{SS}	V _{DD}	NC	NC	ZZ
J	DQ _D	DQ _D	V _{DDQ}	V _{DD}	V _{SS}	V _{SS}	V _{SS}	V _{DD}	V _{DDQ}	DQ _A	DQ _A
K	DQ _D	DQ _D	V _{DDQ}	V _{DD}	V _{SS}	V _{SS}	V _{SS}	V _{DD}	V _{DDQ}	DQ _A	DQ _A
L	DQ _D	DQ _D	V _{DDQ}	V _{DD}	V _{SS}	V _{SS}	V _{SS}	V _{DD}	V _{DDQ}	DQ _A	DQ _A
M	DQ _D	DQ _D	V _{DDQ}	V _{DD}	V _{SS}	V _{SS}	V _{SS}	V _{DD}	V _{DDQ}	DQ _A	DQ _A
N	DQP _D	NC	V _{DDQ}	V _{SS}	NC	NC	NC	V _{SS}	V _{DDQ}	NC	DQP _A
P	NC/144M	NC/72M	A	A	TDI	A1	TDO	A	A	A	NC/288M
R	MODE	NC/36M	A	A	TMS	A0	TCK	A	A	A	A

CY7C1357C (512K x 18)

	1	2	3	4	5	6	7	8	9	10	11
A	NC/576M	A	\overline{CE}_1	\overline{BW}_B	NC	\overline{CE}_3	\overline{CEN}	ADV/LD	A	A	A
B	NC/1G	A	CE2	NC	\overline{BW}_A	CLK	\overline{WE}	\overline{OE}	NC/18M	A	NC
C	NC	NC	V _{DDQ}	V _{SS}	V _{SS}	V _{SS}	V _{SS}	V _{SS}	V _{DDQ}	NC	DQP _A
D	NC	DQ _B	V _{DDQ}	V _{DD}	V _{SS}	V _{SS}	V _{SS}	V _{DD}	V _{DDQ}	NC	DQ _A
E	NC	DQ _B	V _{DDQ}	V _{DD}	V _{SS}	V _{SS}	V _{SS}	V _{DD}	V _{DDQ}	NC	DQ _A
F	NC	DQ _B	V _{DDQ}	V _{DD}	V _{SS}	V _{SS}	V _{SS}	V _{DD}	V _{DDQ}	NC	DQ _A
G	NC	DQ _B	V _{DDQ}	V _{DD}	V _{SS}	V _{SS}	V _{SS}	V _{DD}	V _{DDQ}	NC	DQ _A
H	NC	NC	NC	V _{DD}	V _{SS}	V _{SS}	V _{SS}	V _{DD}	NC	NC	ZZ
J	DQ _B	NC	V _{DDQ}	V _{DD}	V _{SS}	V _{SS}	V _{SS}	V _{DD}	V _{DDQ}	DQ _A	NC
K	DQ _B	NC	V _{DDQ}	V _{DD}	V _{SS}	V _{SS}	V _{SS}	V _{DD}	V _{DDQ}	DQ _A	NC
L	DQ _B	NC	V _{DDQ}	V _{DD}	V _{SS}	V _{SS}	V _{SS}	V _{DD}	V _{DDQ}	DQ _A	NC
M	DQ _B	NC	V _{DDQ}	V _{DD}	V _{SS}	V _{SS}	V _{SS}	V _{DD}	V _{DDQ}	DQ _A	NC
N	DQP _B	NC	V _{DDQ}	V _{SS}	NC	NC	NC	V _{SS}	V _{DDQ}	NC	NC
P	NC/144M	NC/72M	A	A	TDI	A1	TDO	A	A	A	NC/288M
R	MODE	NC/36M	A	A	TMS	A0	TCK	A	A	A	A

Pin Definitions

Name	I/O	Description
A ₀ , A ₁ , A	Input-Synchronous	Address Inputs used to select one of the address locations. Sampled at the rising edge of the CLK. A _[1:0] are fed to the two-bit burst counter.
\overline{BW}_A , \overline{BW}_B \overline{BW}_C , \overline{BW}_D	Input-Synchronous	Byte Write Inputs, active LOW. Qualified with \overline{WE} to conduct Writes to the SRAM. Sampled on the rising edge of CLK.
\overline{WE}	Input-Synchronous	Write Enable Input, active LOW. Sampled on the rising edge of CLK if \overline{CEN} is active LOW. This signal must be asserted LOW to initiate a write sequence.
$\overline{ADV/LD}$	Input-Synchronous	Advance/Load Input. Used to advance the on-chip address counter or load a new address. When HIGH (and \overline{CEN} is asserted LOW) the internal burst counter is advanced. When LOW, a new address can be loaded into the device for an access. After being deselected, $\overline{ADV/LD}$ should be driven LOW in order to load a new address.
CLK	Input-Clock	Clock Input. Used to capture all synchronous inputs to the device. CLK is qualified with \overline{CEN} . CLK is only recognized if \overline{CEN} is active LOW.
CE ₁	Input-Synchronous	Chip Enable 1 Input, active LOW. Sampled on the rising edge of CLK. Used in conjunction with CE ₂ , and CE ₃ to select/deselect the device.
CE ₂	Input-Synchronous	Chip Enable 2 Input, active HIGH. Sampled on the rising edge of CLK. Used in conjunction with CE ₁ and CE ₃ to select/deselect the device.
CE ₃	Input-Synchronous	Chip Enable 3 Input, active LOW. Sampled on the rising edge of CLK. Used in conjunction with CE ₁ and CE ₂ to select/deselect the device.
\overline{OE}	Input-Asynchronous	Output Enable, asynchronous input, active LOW. Combined with the synchronous logic block inside the device to control the direction of the I/O pins. When LOW, the I/O pins are allowed to behave as outputs. When deasserted HIGH, I/O pins are tri-stated, and act as input data pins. \overline{OE} is masked during the data portion of a write sequence, during the first clock when emerging from a deselected state, when the device has been deselected.
\overline{CEN}	Input-Synchronous	Clock Enable Input, active LOW. When asserted LOW the Clock signal is recognized by the SRAM. When deasserted HIGH the Clock signal is masked. Since deasserting \overline{CEN} does not deselect the device, \overline{CEN} can be used to extend the previous cycle when required.
ZZ	Input-Asynchronous	ZZ “Sleep” Input. This active HIGH input places the device in a non-time critical “sleep” condition with data integrity preserved. For normal operation, this pin has to be LOW or left floating. ZZ pin has an internal pull-down.
DQ _s	I/O-Synchronous	Bidirectional Data I/O lines. As inputs, they feed into an on-chip data register that is triggered by the rising edge of CLK. As outputs, they deliver the data contained in the memory location specified by the addresses presented during the previous clock rise of the Read cycle. The direction of the pins is controlled by \overline{OE} . When \overline{OE} is asserted LOW, the pins behave as outputs. When HIGH, DQ _s and DQP _x are placed in a tri-state condition. The outputs are automatically tri-stated during the data portion of a Write sequence, during the first clock when emerging from a deselected state, and when the device is deselected, regardless of the state of \overline{OE} .
DQP _x	I/O-Synchronous	Bidirectional Data Parity I/O Lines. Functionally, these signals are identical to DQ _s . During Write sequences, DQP _x is controlled by \overline{BW}_x correspondingly.
MODE	Input Strap Pin	Mode Input. Selects the burst order of the device. When tied to Gnd selects linear burst sequence. When tied to V _{DD} or left floating selects interleaved burst sequence.
V _{DD}	Power Supply	Power supply inputs to the core of the device.
V _{DDQ}	I/O Power Supply	Power supply for the I/O circuitry.
V _{SS}	Ground	Ground for the device.
TDO	JTAG serial output Synchronous	Serial data-out to the JTAG circuit. Delivers data on the negative edge of TCK. If the JTAG feature is not being utilized, this pin should be left unconnected. This pin is not available on TQFP packages.
TDI	JTAG serial input Synchronous	Serial data-in to the JTAG circuit. Sampled on the rising edge of TCK. If the JTAG feature is not being utilized, this pin can be left floating or connected to V _{DD} through a pull up resistor. This pin is not available on TQFP packages.

Pin Definitions (continued)

Name	I/O	Description
TMS	JTAG serial input Synchronous	Serial data-In to the JTAG circuit. Sampled on the rising edge of TCK. If the JTAG feature is not being utilized, this pin can be disconnected or connected to V_{DD} . This pin is not available on TQFP packages.
TCK	JTAG Clock	Clock input to the JTAG circuitry. If the JTAG feature is not being utilized, this pin must be connected to V_{SS} . This pin is not available on TQFP packages.
NC	–	No Connects. Not internally connected to the die. 18 Mbit, 36 Mbit, 72 Mbit, 144 Mbit, 288 Mbit, 576 Mbit and 1G are address expansion pins and are not internally connected to the die.
V_{SS}/DNU	Ground/DNU	This pin can be connected to Ground or should be left floating.

Functional Overview

The CY7C1355C/CY7C1357C is a synchronous flow-through burst SRAM designed specifically to eliminate wait states during Write-Read transitions. All synchronous inputs pass through input registers controlled by the rising edge of the clock. The clock signal is qualified with the Clock Enable input signal (CEN). If CEN is HIGH, the clock signal is not recognized and all internal states are maintained. All synchronous operations are qualified with CEN. Maximum access delay from the clock rise (t_{CDV}) is 6.5 ns (133-MHz device).

Accesses can be initiated by asserting all three Chip Enables (\overline{CE}_1 , \overline{CE}_2 , \overline{CE}_3) active at the rising edge of the clock. If Clock Enable (CEN) is active LOW and ADV/LD is asserted LOW, the address presented to the device will be latched. The access can either be a Read or Write operation, depending on the status of the Write Enable (WE). \overline{BW}_X can be used to conduct Byte Write operations.

Write operations are qualified by the Write Enable (\overline{WE}). All writes are simplified with on-chip synchronous self-timed Write circuitry.

Three synchronous Chip Enables (\overline{CE}_1 , \overline{CE}_2 , \overline{CE}_3) and an asynchronous Output Enable (OE) simplify depth expansion. All operations (Reads, Writes, and Deselects) are pipelined. ADV/LD should be driven LOW once the device has been deselected in order to load a new address for the next operation.

Single Read Accesses

A read access is initiated when the following conditions are satisfied at clock rise: (1) CEN is asserted LOW, (2) \overline{CE}_1 , \overline{CE}_2 , and \overline{CE}_3 are ALL asserted active, (3) the Write Enable input signal WE is deasserted HIGH, and 4) ADV/LD is asserted LOW. The address presented to the address inputs is latched into the address register and presented to the memory array and control logic. The control logic determines that a read access is in progress and allows the requested data to propagate to the output buffers. The data is available within 7.5 ns (133-MHz device) provided OE is active LOW. After the first clock of the read access, the output buffers are controlled by OE and the internal control logic. OE must be driven LOW in order for the device to drive out the requested data. On the subsequent clock, another operation (Read/Write/Deselect) can be initiated. When the SRAM is deselected at clock rise by one of the chip enable signals, its output will be tri-stated immediately.

Burst Read Accesses

The CY7C1355C/CY7C1357C has an on-chip burst counter that allows the user the ability to supply a single address and conduct up to four Reads without reasserting the address inputs. ADV/LD must be driven LOW in order to load a new address into the SRAM, as described in the Single Read Access section above. The sequence of the burst counter is determined by the MODE input signal. A LOW input on MODE selects a linear burst mode, a HIGH selects an interleaved burst sequence. Both burst counters use A0 and A1 in the burst sequence, and will wrap around when incremented sufficiently. A HIGH input on ADV/LD will increment the internal burst counter regardless of the state of chip enable inputs or \overline{WE} . \overline{WE} is latched at the beginning of a burst cycle. Therefore, the type of access (Read or Write) is maintained throughout the burst sequence.

Single Write Accesses

Write access are initiated when the following conditions are satisfied at clock rise: (1) CEN is asserted LOW, (2) \overline{CE}_1 , \overline{CE}_2 , and \overline{CE}_3 are ALL asserted active, and (3) the Write signal WE is asserted LOW. The address presented to the address bus is loaded into the address register. The write signals are latched into the Control Logic block. The data lines are automatically tri-stated regardless of the state of the OE input signal. This allows the external logic to present the data on DQs and DQP_X.

On the next clock rise the data presented to DQs and DQP_X (or a subset for byte write operations, see Truth Table for details) inputs is latched into the device and the write is complete. Additional accesses (Read/Write/Deselect) can be initiated on this cycle.

The data written during the Write operation is controlled by \overline{BW}_X signals. The CY7C1355C/CY7C1357C provides byte write capability that is described in the Truth Table. Asserting the Write Enable input (WE) with the selected Byte Write Select input will selectively write to only the desired bytes. Bytes not selected during a byte write operation will remain unaltered. A synchronous self-timed Write mechanism has been provided to simplify the Write operations. Byte Write capability has been included in order to greatly simplify Read/Modify/Write sequences, which can be reduced to simple Byte Write operations.

Because the CY7C1355C/CY7C1357C is a common I/O device, data should not be driven into the device while the outputs are active. The Output Enable (OE) can be deasserted HIGH before presenting data to the DQs and DQP_X inputs. Doing so will tri-state the output drivers. As a safety

precaution, DQs and DQP_X are automatically tri-stated during the data portion of a write cycle, regardless of the state of OE.

Burst Write Accesses

The CY7C1355C/CY7C1357C has an on-chip burst counter that allows the user the ability to supply a single address and conduct up to four Write operations without reasserting the address inputs. ADV/LD must be driven LOW in order to load the initial address, as described in the Single Write Access section above. When ADV/LD is driven HIGH on the subsequent clock rise, the Chip Enables (CE₁, CE₂, and CE₃) and WE inputs are ignored and the burst counter is incremented. The correct BW_X inputs must be driven in each cycle of the burst write, in order to write the correct bytes of data.

Sleep Mode

The ZZ input pin is an asynchronous input. Asserting ZZ places the SRAM in a power conservation “sleep” mode. Two clock cycles are required to enter into or exit from this “sleep” mode. While in this mode, data integrity is guaranteed. Accesses pending when entering the “sleep” mode are not considered valid nor is the completion of the operation guaranteed. The device must be deselected prior to entering the “sleep” mode. CE₁, CE₂, and CE₃, must remain inactive for the duration of t_{ZZREC} after the ZZ input returns LOW.

ZZ Mode Electrical Characteristics

Parameter	Description	Test Conditions	Min.	Max.	Unit
I _{DDZZ}	Sleep mode standby current	ZZ ≥ V _{DD} - 0.2V		50	mA
t _{ZZS}	Device operation to ZZ	ZZ ≥ V _{DD} - 0.2V		2t _{CYC}	ns
t _{ZZREC}	ZZ recovery time	ZZ ≤ 0.2V	2t _{CYC}		ns
t _{ZZI}	ZZ active to sleep current	This parameter is sampled		2t _{CYC}	ns
t _{RZZI}	ZZ Inactive to exit sleep current	This parameter is sampled	0		ns

Truth Table^[2, 3, 4, 5, 6, 7, 8]

Operation	Address Used	CE ₁	CE ₂	CE ₃	ZZ	ADV/LD	WE	BW _X	OE	CEN	CLK	DQ
Deselect Cycle	None	H	X	X	L	L	X	X	X	L	L->H	Tri-State
Deselect Cycle	None	X	X	H	L	L	X	X	X	L	L->H	Tri-State
Deselect Cycle	None	X	L	X	L	L	X	X	X	L	L->H	Tri-State
Continue Deselect Cycle	None	X	X	X	L	H	X	X	X	L	L->H	Tri-State
READ Cycle (Begin Burst)	External	L	H	L	L	L	H	X	L	L	L->H	Data Out (Q)
READ Cycle (Continue Burst)	Next	X	X	X	L	H	X	X	L	L	L->H	Data Out (Q)
NOP/DUMMY READ (Begin Burst)	External	L	H	L	L	L	H	X	H	L	L->H	Tri-State
DUMMY READ (Continue Burst)	Next	X	X	X	L	H	X	X	H	L	L->H	Tri-State
WRITE Cycle (Begin Burst)	External	L	H	L	L	L	L	L	X	L	L->H	Data In (D)
WRITE Cycle (Continue Burst)	Next	X	X	X	L	H	X	L	X	L	L->H	Data In (D)

Notes:

- X = “Don’t Care.” H = Logic HIGH, L = Logic LOW. BW_X = L signifies at least one Byte Write Select is active, BW_X = Valid signifies that the desired Byte Write Selects are asserted, see Truth Table for details.
- Write is defined by BW_X, and WE. See Truth Table for Read/Write.
- When a Write cycle is detected, all I/Os are tri-stated, even during Byte Writes.
- The DQs and DQP_X pins are controlled by the current cycle and the OE signal. OE is asynchronous and is not sampled with the clock.
- CEN = H, inserts wait states.
- Device will power-up deselected and the I/Os in a tri-state condition, regardless of OE.
- OE is asynchronous and is not sampled with the clock rise. It is masked internally during Write cycles. During a Read cycle DQs and DQP_X = Tri-state when OE is inactive or when the device is deselected, and DQs and DQP_X = data when OE is active.

Interleaved Burst Address Table (MODE = Floating or VDD)

First Address A1: A0	Second Address A1: A0	Third Address A1: A0	Fourth Address A1: A0
00	01	10	11
01	00	11	10
10	11	00	01
11	10	01	00

Linear Burst Address Table (MODE = GND)

First Address A1: A0	Second Address A1: A0	Third Address A1: A0	Fourth Address A1: A0
00	01	10	11
01	10	11	00
10	11	00	01
11	00	01	10

Truth Table^[2, 3, 4, 5, 6, 7, 8]

Operation	Address Used	\overline{CE}_1	CE_2	\overline{CE}_3	ZZ	ADV/LD	\overline{WE}	\overline{BW}_X	\overline{OE}	\overline{CEN}	CLK	DQ
NOP/WRITE ABORT (Begin Burst)	None	L	H	L	L	L	L	H	X	L	L->H	Tri-State
WRITE ABORT (Continue Burst)	Next	X	X	X	L	H	X	H	X	L	L->H	Tri-State
IGNORE CLOCK EDGE (Stall)	Current	X	X	X	L	X	X	X	X	H	L->H	–
SLEEP MODE	None	X	X	X	H	X	X	X	X	X	X	Tri-State

Partial Truth Table for Read/Write^[2, 3, 9]

Function (CY7C1355C)	\overline{WE}	\overline{BW}_A	\overline{BW}_B	\overline{BW}_C	\overline{BW}_D
Read	H	X	X	X	X
Write No bytes written	L	H	H	H	H
Write Byte A – (DQ _A and DQP _A)	L	L	H	H	H
Write Byte B – (DQ _B and DQP _B)	L	H	L	H	H
Write Byte C – (DQ _C and DQP _C)	L	H	H	L	H
Write Byte D – (DQ _D and DQP _D)	L	H	H	H	L
Write All Bytes	L	L	L	L	L

Truth Table for Read/Write^[2, 3, 9]

Function (CY7C1357C)	\overline{WE}	\overline{BW}_A	\overline{BW}_B
Read	H	X	X
Write - No bytes written	L	H	H
Write Byte A – (DQ _A and DQP _A)	L	H	H
Write Byte B – (DQ _B and DQP _B)	L	H	H
Write All Bytes	L	L	L

Note:

9. Table only lists a partial listing of the byte write combinations. Any combination of \overline{BW}_X is valid. Appropriate write will be done based on which byte write is active.

IEEE 1149.1 Serial Boundary Scan (JTAG)

The CY7C1355C/CY7C1357C incorporates a serial boundary scan test access port (TAP) in the BGA package only. The TQFP package does not offer this functionality. This part operates in accordance with IEEE Standard 1149.1-1900, but doesn't have the set of functions required for full 1149.1 compliance. These functions from the IEEE specification are excluded because their inclusion places an added delay in the critical speed path of the SRAM. Note the TAP controller functions in a manner that does not conflict with the operation of other devices using 1149.1 fully compliant TAPs. The TAP operates using JEDEC-standard 3.3V or 2.5V I/O logic levels.

The CY7C1355C/CY7C1357C contains a TAP controller, instruction register, boundary scan register, bypass register, and ID register.

Disabling the JTAG Feature

It is possible to operate the SRAM without using the JTAG feature. To disable the TAP controller, TCK must be tied LOW (Vss) to prevent clocking of the device. TDI and TMS are internally pulled up and may be unconnected. They may alternately be connected to VDD through a pull-up resistor. TDO should be left unconnected. Upon power-up, the device will come up in a reset state which will not interfere with the operation of the device.

TAP Controller State Diagram

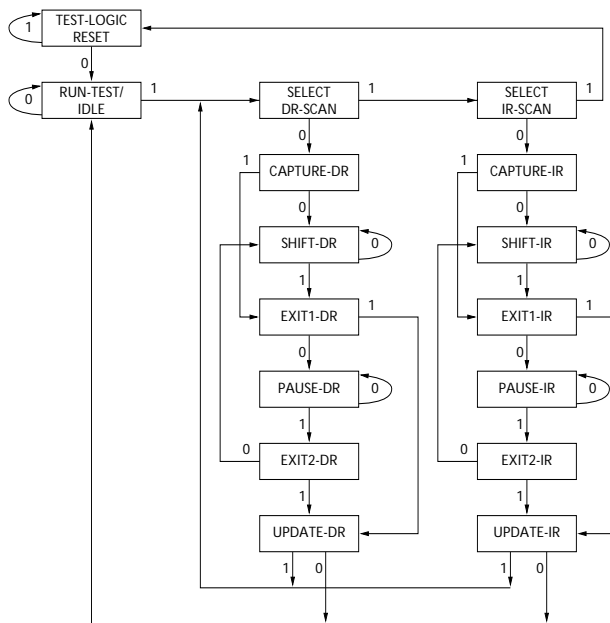

The 0/1 next to each state represents the value of TMS at the rising edge of the TCK.

Test Access Port (TAP)

Test Clock (TCK)

The test clock is used only with the TAP controller. All inputs are captured on the rising edge of TCK. All outputs are driven from the falling edge of TCK.

Test MODE SELECT (TMS)

The TMS input is used to give commands to the TAP controller and is sampled on the rising edge of TCK. It is allowable to leave this ball unconnected if the TAP is not used. The ball is pulled up internally, resulting in a logic HIGH level.

Test Data-In (TDI)

The TDI ball is used to serially input information into the registers and can be connected to the input of any of the registers. The register between TDI and TDO is chosen by the instruction that is loaded into the TAP instruction register. TDI is internally pulled up and can be unconnected if the TAP is unused in an application. TDI is connected to the most significant bit (MSB) of any register. (See Tap Controller Block Diagram.)

Test Data-Out (TDO)

The TDO output ball is used to serially clock data-out from the registers. The output is active depending upon the current state of the TAP state machine. The output changes on the falling edge of TCK. TDO is connected to the least significant bit (LSB) of any register. (See Tap Controller State Diagram.)

TAP Controller Block Diagram

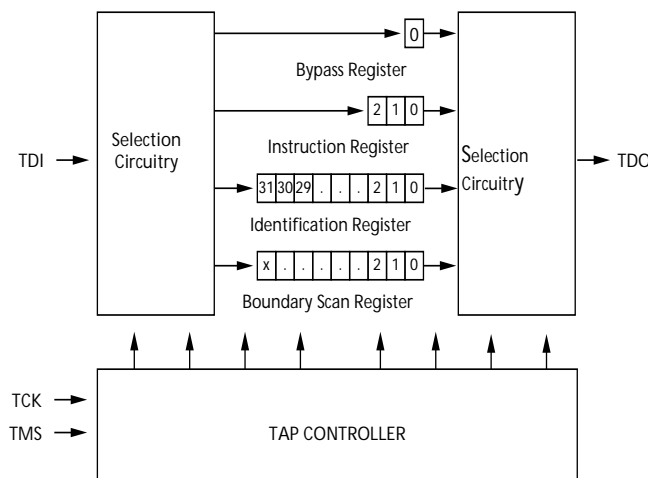

Performing a TAP Reset

A RESET is performed by forcing TMS HIGH (VDD) for five rising edges of TCK. This RESET does not affect the operation of the SRAM and may be performed while the SRAM is operating.

At power-up, the TAP is reset internally to ensure that TDO comes up in a High-Z state.

TAP Registers

Registers are connected between the TDI and TDO balls and allow data to be scanned into and out of the SRAM test circuitry. Only one register can be selected at a time through the instruction register. Data is serially loaded into the TDI ball on the rising edge of TCK. Data is output on the TDO ball on the falling edge of TCK.

Instruction Register

Three-bit instructions can be serially loaded into the instruction register. This register is loaded when it is placed between the TDI and TDO balls as shown in the Tap Controller Block

Diagram. Upon power-up, the instruction register is loaded with the IDCODE instruction. It is also loaded with the IDCODE instruction if the controller is placed in a reset state as described in the previous section.

When the TAP controller is in the Capture-IR state, the two least significant bits are loaded with a binary “01” pattern to allow for fault isolation of the board-level serial test data path.

Bypass Register

To save time when serially shifting data through registers, it is sometimes advantageous to skip certain chips. The bypass register is a single-bit register that can be placed between the TDI and TDO balls. This allows data to be shifted through the SRAM with minimal delay. The bypass register is set LOW (Vss) when the BYPASS instruction is executed.

Boundary Scan Register

The boundary scan register is connected to all the input and bidirectional balls on the SRAM.

The boundary scan register is loaded with the contents of the RAM I/O ring when the TAP controller is in the Capture-DR state and is then placed between the TDI and TDO balls when the controller is moved to the Shift-DR state. The EXTEST, SAMPLE/PRELOAD and SAMPLE Z instructions can be used to capture the contents of the I/O ring.

The Boundary Scan Order tables show the order in which the bits are connected. Each bit corresponds to one of the bumps on the SRAM package. The MSB of the register is connected to TDI, and the LSB is connected to TDO.

Identification (ID) Register

The ID register is loaded with a vendor-specific, 32-bit code during the Capture-DR state when the IDCODE command is loaded in the instruction register. The IDCODE is hardwired into the SRAM and can be shifted out when the TAP controller is in the Shift-DR state. The ID register has a vendor code and other information described in the Identification Register Definitions table.

TAP Instruction Set

Overview

Eight different instructions are possible with the three bit instruction register. All combinations are listed in the Instruction Codes table. Three of these instructions are listed as RESERVED and should not be used. The other five instructions are described in detail below.

Instructions are loaded into the TAP controller during the Shift-IR state when the instruction register is placed between TDI and TDO. During this state, instructions are shifted through the instruction register through the TDI and TDO balls. To execute the instruction once it is shifted in, the TAP controller needs to be moved into the Update-IR state.

IDCODE

The IDCODE instruction causes a vendor-specific, 32-bit code to be loaded into the instruction register. It also places the instruction register between the TDI and TDO balls and allows the IDCODE to be shifted out of the device when the TAP controller enters the Shift-DR state. The IDCODE instruction is loaded into the instruction register upon power-up or whenever the TAP controller is given a test logic reset state.

SAMPLE Z

The SAMPLE Z instruction causes the boundary scan register to be connected between the TDI and TDO pins when the TAP controller is in a Shift-DR state. The SAMPLE Z command puts the output bus into a High-Z state until the next command is given during the “Update IR” state.

SAMPLE/PRELOAD

SAMPLE/PRELOAD is a 1149.1 mandatory instruction. When the SAMPLE/PRELOAD instructions are loaded into the instruction register and the TAP controller is in the Capture-DR state, a snapshot of data on the inputs and output pins is captured in the boundary scan register.

The user must be aware that the TAP controller clock can only operate at a frequency up to 20 MHz, while the SRAM clock operates more than an order of magnitude faster. Because there is a large difference in the clock frequencies, it is possible that during the Capture-DR state, an input or output will undergo a transition. The TAP may then try to capture a signal while in transition (metastable state). This will not harm the device, but there is no guarantee as to the value that will be captured. Repeatable results may not be possible.

To guarantee that the boundary scan register will capture the correct value of a signal, the SRAM signal must be stabilized long enough to meet the TAP controller’s capture set-up plus hold times (t_{CS} and t_{CH}). The SRAM clock input might not be captured correctly if there is no way in a design to stop (or slow) the clock during a SAMPLE/PRELOAD instruction. If this is an issue, it is still possible to capture all other signals and simply ignore the value of the CK and CK# captured in the boundary scan register.

Once the data is captured, it is possible to shift out the data by putting the TAP into the Shift-DR state. This places the boundary scan register between the TDI and TDO pins.

PRELOAD allows an initial data pattern to be placed at the latched parallel outputs of the boundary scan register cells prior to the selection of another boundary scan test operation.

The shifting of data for the SAMPLE and PRELOAD phases can occur concurrently when required—that is, while data captured is shifted out, the preloaded data can be shifted in.

BYPASS

When the BYPASS instruction is loaded in the instruction register and the TAP is placed in a Shift-DR state, the bypass register is placed between the TDI and TDO pins. The advantage of the BYPASS instruction is that it shortens the boundary scan path when multiple devices are connected together on a board.

EXTEST

The EXTEST instruction enables the preloaded data to be driven out through the system output pins. This instruction also selects the boundary scan register to be connected for serial access between the TDI and TDO in the shift-DR controller state.

Reserved

These instructions are not implemented but are reserved for future use. Do not use these instructions.

TAP Timing

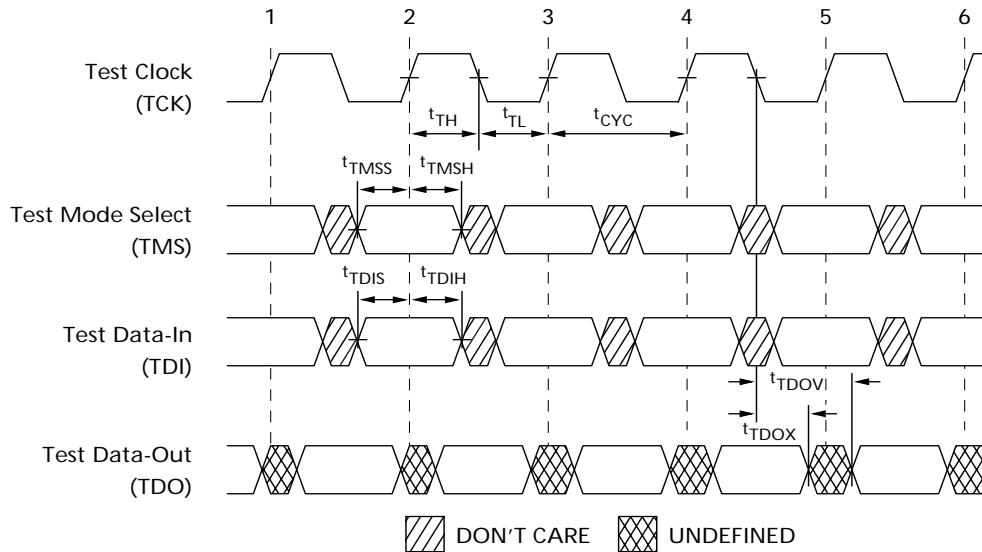

TAP AC Switching Characteristics Over the Operating Range^[10, 11]

Parameter	Description	Min.	Max.	Unit
Clock				
t_{TCYC}	TCK Clock Cycle Time	50		ns
t_{TF}	TCK Clock Frequency		20	MHz
t_{TH}	TCK Clock HIGH Time	20		ns
t_{TL}	TCK Clock LOW Time	20		ns
Output Times				
t_{TDOV}	TCK Clock LOW to TDO Valid		10	ns
t_{TDOX}	TCK Clock LOW to TDO Invalid	0		ns
Set-up Times				
t_{TMSS}	TMS Set-Up to TCK Clock Rise	5		ns
t_{TDIS}	TDI Set-Up to TCK Clock Rise	5		ns
t_{CS}	Capture Set-Up to TCK Rise	5		ns
Hold Times				
t_{TMSH}	TMS Hold after TCK Clock Rise	5		ns
t_{TDIH}	TDI Hold after Clock Rise	5		ns
t_{CH}	Capture Hold after Clock Rise	5		ns

Notes:

10. t_{CS} and t_{CH} refer to the set-up and hold time requirements of latching data from the boundary scan register.
 11. Test conditions are specified using the load in TAP AC Test Conditions. $t_R/t_F = 1$ ns.

3.3V TAP AC Test Conditions

Input pulse levels V_{SS} to 3.3V
 Input rise and fall times 1 ns
 Input timing reference levels 1.5V
 Output reference levels 1.5V
 Test load termination supply voltage 1.5V

2.5V TAP AC Test Conditions

Input pulse levels V_{SS} to 2.5V
 Input rise and fall time 1 ns
 Input timing reference levels 1.25V
 Output reference levels 1.25V
 Test load termination supply voltage 1.25V

3.3V TAP AC Output Load Equivalent

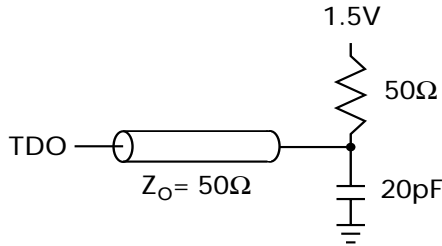

2.5V TAP AC Output Load Equivalent

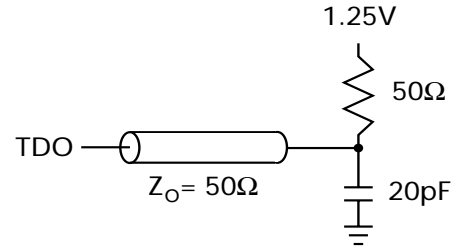

TAP DC Electrical Characteristics And Operating Conditions ($0^{\circ}\text{C} < T_A < +70^{\circ}\text{C}$; $V_{DD} = 3.3\text{V} \pm 0.165\text{V}$ unless otherwise noted)^[12]

Parameter	Description	Conditions	Min.	Max.	Unit
V_{OH1}	Output HIGH Voltage	$I_{OH} = -4.0\text{ mA}$, $V_{DDQ} = 3.3\text{V}$ $I_{OH} = -1.0\text{ mA}$, $V_{DDQ} = 2.5\text{V}$	2.4		V
			2.0		V
V_{OH2}	Output HIGH Voltage	$I_{OH} = -100\text{ }\mu\text{A}$	$V_{DDQ} = 3.3\text{V}$	2.9	V
			$V_{DDQ} = 2.5\text{V}$	2.1	V
V_{OL1}	Output LOW Voltage	$I_{OL} = 8.0\text{ mA}$	$V_{DDQ} = 3.3\text{V}$	0.4	V
			$V_{DDQ} = 2.5\text{V}$	0.4	V
V_{OL2}	Output LOW Voltage	$I_{OL} = 100\text{ }\mu\text{A}$	$V_{DDQ} = 3.3\text{V}$	0.2	V
			$V_{DDQ} = 2.5\text{V}$	0.2	V
V_{IH}	Input HIGH Voltage		$V_{DDQ} = 3.3\text{V}$	2.0	$V_{DD} + 0.3$ V
			$V_{DDQ} = 2.5\text{V}$	1.7	$V_{DD} + 0.3$ V
V_{IL}	Input LOW Voltage		$V_{DDQ} = 3.3\text{V}$	-0.5	0.7 V
			$V_{DDQ} = 2.5\text{V}$	-0.3	0.7 V
I_X	Input Load Current	$\text{GND} \leq V_{IN} \leq V_{DDQ}$	-5	5	μA

Identification Register Definitions

Instruction Field	CY7C1355C (256Kx36)	CY7C1357C (512Kx18)	Description
Revision Number (31:29)	010	010	Describes the version number
Device Depth (28:24)	01010	01010	Reserved for Internal Use
Device Width (23:18)	001001	001001	Defines memory type and architecture
Cypress Device ID (17:12)	100110	010110	Defines width and density
Cypress JEDEC ID Code (11:1)	00000110100	00000110100	Allows unique identification of SRAM vendor
ID Register Presence Indicator (0)	1	1	Indicates the presence of an ID register

Note:
 12. All voltages referenced to V_{SS} (GND).

Scan Register Sizes

Register Name	Bit Size (x36)	Bit Size (x18)
Instruction	3	3
Bypass	1	1
ID	32	32
Boundary Scan Order (119-ball BGA package)	69	69
Boundary Scan Order (165-ball FBGA package)	69	69

Identification Codes

Instruction	Code	Description
EXTEST	000	Captures I/O ring contents. Places the boundary scan register between TDI and TDO. Forces all SRAM outputs to High-Z state. This instruction is not 1149.1 compliant.
IDCODE	001	Loads the ID register with the vendor ID code and places the register between TDI and TDO. This operation does not affect SRAM operations.
SAMPLE Z	010	Captures I/O ring contents. Places the boundary scan register between TDI and TDO. Forces all SRAM output drivers to a High-Z state.
RESERVED	011	Do Not Use: This instruction is reserved for future use.
SAMPLE/PRELOAD	100	Captures I/O ring contents. Places the boundary scan register between TDI and TDO. Does not affect SRAM operation. This instruction does not implement 1149.1 preload function and is therefore not 1149.1 compliant.
RESERVED	101	Do Not Use: This instruction is reserved for future use.
RESERVED	110	Do Not Use: This instruction is reserved for future use.
BYPASS	111	Places the bypass register between TDI and TDO. This operation does not affect SRAM operations.

119-ball BGA Boundary Scan Order

CY7C1355C (256K x 36)					
Bit#	ball ID	Signal Name	Bit#	ball ID	Signal Name
1	K4	CLK	37	R6	A
2	H4	\overline{WE}	38	T5	A
3	M4	\overline{CEN}	39	T3	A
4	F4	\overline{OE}	40	R2	A
5	B4	ADV/LD	41	R3	MODE
6	G4	A	42	P2	DQP _D
7	C3	A	43	P1	DQ _D
8	B3	A	44	L2	DQ _D
9	D6	DQP _B	45	K1	DQ _D
10	H7	DQ _B	46	N2	DQ _D
11	G6	DQ _B	47	N1	DQ _D
12	E6	DQ _B	48	M2	DQ _D
13	D7	DQ _B	49	L1	DQ _D
14	E7	DQ _B	50	K2	DQ _D
15	F6	DQ _B	51	Internal	Internal
16	G7	DQ _B	52	H1	DQ _C
17	H6	DQ _B	53	G2	DQ _C
18	T7	ZZ	54	E2	DQ _C
19	K7	DQ _A	55	D1	DQ _C
20	L6	DQ _A	56	H2	DQ _C
21	N6	DQ _A	57	G1	DQ _C
22	P7	DQ _A	58	F2	DQ _C
23	N7	DQ _A	59	E1	DQ _C
24	M6	DQ _A	60	D2	DQP _C
25	L7	DQ _A	61	C2	A
26	K6	DQ _A	62	A2	A
27	P6	DQP _A	63	E4	\overline{CE}_1
28	T4	A	64	B2	\overline{CE}_2
29	A3	A	65	L3	\overline{BW}_D
30	C5	A	66	G3	\overline{BW}_C
31	B5	A	67	G5	\overline{BWB}
32	A5	A	68	L5	\overline{BW}_A
33	C6	A	69	B6	\overline{CE}_3
34	A6	A			
35	P4	A0			
36	N4	A1			

CY7C1357C (512K x 18)					
Bit#	ball Id	Signal Name	Bit#	ball Id	Signal Name
1	K4	CLK	37	R6	A
2	H4	\overline{WE}	38	T5	A
3	M4	\overline{CEN}	39	T3	A
4	F4	\overline{OE}	40	R2	A
5	B4	ADV/LD	41	R3	MODE
6	G4	A	42	Internal	Internal
7	C3	A	43	Internal	Internal
8	B3	A	44	Internal	Internal
9	T2	A	45	Internal	Internal
10	Internal	Internal	46	P2	DQP _B
11	Internal	Internal	47	N1	DQ _B
12	Internal	Internal	48	M2	DQ _B
13	D6	DQP _A	49	L1	DQ _B
14	E7	DQ _A	50	K2	DQ _B
15	F6	DQ _A	51	Internal	Internal
16	G7	DQ _A	52	H1	DQ _B
17	H6	DQ _A	53	G2	DQ _B
18	T7	ZZ	54	E2	DQ _B
19	K7	DQ _A	55	D1	DQ _B
20	L6	DQ _A	56	Internal	Internal
21	N6	DQ _A	57	Internal	Internal
22	P7	DQ _A	58	Internal	Internal
23	Internal	Internal	59	Internal	Internal
24	Internal	Internal	60	Internal	Internal
25	Internal	Internal	61	C2	A
26	Internal	Internal	62	A2	A
27	Internal	Internal	63	E4	\overline{CE}_1
28	T6	A	64	B2	\overline{CE}_2
29	A3	A	65	Internal	Internal
30	C5	A	66	G3	\overline{BW}_B
31	B5	A	67	Internal	Internal
32	A5	A	68	L5	\overline{BW}_A
33	C6	A	69	B6	\overline{CE}_3
34	A6	A			
35	P4	A0			
36	N4	A1			

165-ball FBGA Boundary Scan Order

CY7C1355C (256K x 36)					
Bit#	ball ID	Signal Name	Bit#	ball ID	Signal Name
1	B6	CLK	37	R4	A
2	B7	\overline{WE}	38	P4	A
3	A7	\overline{CEN}	39	R3	A
4	B8	\overline{OE}	40	P3	A
5	A8	ADV/LD	41	R1	MODE
6	A9	A	42	N1	DQP _D
7	B10	A	43	L2	DQ _D
8	A10	A	44	K2	DQ _D
9	C11	DQP _B	45	J2	DQ _D
10	E10	DQ _B	46	M2	DQ _D
11	F10	DQ _B	47	M1	DQ _D
12	G10	DQ _B	48	L1	DQ _D
13	D10	DQ _B	49	K1	DQ _D
14	D11	DQ _B	50	J1	DQ _D
15	E11	DQ _B	51	Internal	Internal
16	F11	DQ _B	52	G2	DQ _C
17	G11	DQ _B	53	F2	DQ _C
18	H11	ZZ	54	E2	DQ _C
19	J10	DQ _A	55	D2	DQ _C
20	K10	DQ _A	56	G1	DQ _C
21	L10	DQ _A	57	F1	DQ _C
22	M10	DQ _A	58	E1	DQ _C
23	J11	DQ _A	59	D1	DQ _C
24	K11	DQ _A	60	C1	DQP _C
25	L11	DQ _A	61	B2	A
26	M11	DQ _A	62	A2	A
27	N11	DQP _A	63	A3	CE ₁
28	R11	A	64	B3	CE ₂
29	R10	A	65	B4	BW _D
30	P10	A	66	A4	$\overline{BW_C}$
31	R9	A	67	A5	$\overline{BW_B}$
32	P9	A	68	B5	$\overline{BW_A}$
33	R8	A	69	A6	$\overline{CE_3}$
34	P8	A			
35	R6	A0			
36	P6	A1			

CY7C1357C (512K x 18)					
Bit#	ball ID	Signal Name	Bit#	ball ID	Signal Name
1	B6	CLK	37	R4	A
2	B7	\overline{WE}	38	P4	A
3	A7	\overline{CEN}	39	R3	A
4	B8	\overline{OE}	40	P3	A
5	A8	ADV/LD	41	R1	MODE
6	A9	A	42	Internal	Internal
7	B10	A	43	Internal	Internal
8	A10	A	44	Internal	Internal
9	A11	A	45	Internal	Internal
10	Internal	Internal	46	N1	DQP _B
11	Internal	Internal	47	M1	DQ _B
12	Internal	Internal	48	L1	DQ _B
13	C11	DQP _A	49	K1	DQ _B
14	D11	DQ _A	50	J1	DQ _B
15	E11	DQ _A	51	Internal	Internal
16	F11	DQ _A	52	G2	DQ _B
17	G11	DQ _A	53	F2	DQ _B
18	H11	ZZ	54	E2	DQ _B
19	J10	DQ _A	55	D2	DQ _B
20	K10	DQ _A	56	Internal	Internal
21	L10	DQ _A	57	Internal	Internal
22	M10	DQ _A	58	Internal	Internal
23	Internal	Internal	59	Internal	Internal
24	Internal	Internal	60	Internal	Internal
25	Internal	Internal	61	B2	A
26	Internal	Internal	62	A2	A
27	Internal	Internal	63	A3	CE ₁
28	R11	A	64	B3	CE ₂
29	R10	A	65	Internal	Internal
30	P10	A	66	Internal	Internal
31	R9	A	67	A4	$\overline{BW_B}$
32	P9	A	68	B5	$\overline{BW_A}$
33	R8	A	69	A6	$\overline{CE_3}$
34	P8	A			
35	R6	A0			
36	P6	A1			

Maximum Ratings

(Above which the useful life may be impaired. For user guidelines, not tested.)

- Storage Temperature -65°C to +150°C
- Ambient Temperature with Power Applied..... -55°C to +125°C
- Supply Voltage on V_{DD} Relative to GND..... -0.5V to +4.6V
- Supply Voltage on V_{DDQ} Relative to GND -0.5V to +V_{DD}
- DC Voltage Applied to Outputs in Tri-State..... -0.5V to V_{DDQ} + 0.5V

- DC Input Voltage -0.5V to V_{DD} + 0.5V
- Current into Outputs (LOW)..... 20 mA
- Static Discharge Voltage..... > 2001V (per MIL-STD-883, Method 3015)
- Latch-up Current..... > 200 mA.

Operating Range

Range	Ambient Temperature	V _{DD}	V _{DDQ}
Commercial	0°C to +70°C	3.3V – 5%/+10%	2.5V – 5% to V _{DD}
Industrial	-40°C to +85°C		

Electrical Characteristics Over the Operating Range^[13, 14]

Parameter	Description	Test Conditions	Min.	Max.	Unit
V _{DD}	Power Supply Voltage		3.135	3.6	V
V _{DDQ}	I/O Supply Voltage	for 3.3V I/O	3.135	V _{DD}	V
		for 2.5V I/O	2.375	2.625	
V _{OH}	Output HIGH Voltage	for 3.3V I/O, I _{OH} = -4.0 mA	2.4		V
		for 2.5V I/O, I _{OH} = -1.0 mA	2.0		V
V _{OL}	Output LOW Voltage	for 3.3V I/O, I _{OL} = 8.0 mA		0.4	V
		for 2.5V I/O, I _{OL} = 1.0 mA		0.4	V
V _{IH}	Input HIGH Voltage ^[13]	for 3.3V I/O	2.0	V _{DD} + 0.3V	V
		for 2.5V I/O	1.7	V _{DD} + 0.3V	V
V _{IL}	Input LOW Voltage ^[13]	for 3.3V I/O	-0.3	0.8	V
		for 2.5V I/O	-0.3	0.7	V
I _X	Input Leakage Current except ZZ and MODE	GND ≤ V _I ≤ V _{DDQ}	-5	5	μA
	Input Current of MODE	Input = V _{SS}	-30		μA
		Input = V _{DD}		5	μA
	Input Current of ZZ	Input = V _{SS}	-5		μA
Input = V _{DD}			30	μA	
I _{OZ}	Output Leakage Current	GND ≤ V _I ≤ V _{DDQ} , Output Disabled	-5	5	μA
I _{DD}	V _{DD} Operating Supply Current	V _{DD} = Max., I _{OUT} = 0 mA, f = f _{MAX} = 1/t _{CYC}	7.5-ns cycle, 133 MHz	250	mA
			10-ns cycle, 100 MHz	180	mA
I _{SB1}	Automatic CE Power-down Current—TTL Inputs	V _{DD} = Max, Device Deselected, V _{IN} ≥ V _{IH} or V _{IN} ≤ V _{IL} , f = f _{MAX} , inputs switching		110	mA
I _{SB2}	Automatic CE Power-down Current—CMOS Inputs	V _{DD} = Max, Device Deselected, V _{IN} ≤ 0.3V or V _{IN} ≥ V _{DD} - 0.3V, f = 0, inputs static		40	mA
I _{SB3}	Automatic CE Power-down Current—CMOS Inputs	V _{DD} = Max, Device Deselected, or V _{IN} ≤ 0.3V or V _{IN} ≥ V _{DDQ} - 0.3V, f = f _{MAX} , inputs switching		100	mA
I _{SB4}	Automatic CE Power-down Current—TTL Inputs	V _{DD} = Max, Device Deselected, V _{IN} ≥ V _{IH} or V _{IN} ≤ V _{IL} , f = 0, inputs static		40	mA

Notes:

- 13. Overshoot: V_{IH}(AC) < V_{DD} +1.5V (Pulse width less than t_{CYC}/2), undershoot: V_{IL}(AC) > -2V (Pulse width less than t_{CYC}/2).
- 14. T_{Power-up}: Assumes a linear ramp from 0V to V_{DD}(min.) within 200 ms. During this time V_{IH} < V_{DD} and V_{DDQ} ≤ V_{DD}.

Capacitance^[15]

Parameter	Description	Test Conditions	100 TQFP Max.	119 BGA Max.	165 FBGA Max.	Unit
C _{IN}	Input Capacitance	T _A = 25°C, f = 1 MHz, V _{DD} = 3.3V, V _{DDQ} = 2.5V	5	5	5	pF
C _{CLK}	Clock Input Capacitance		5	5	5	pF
C _{I/O}	Input/Output Capacitance		5	7	7	pF

Thermal Resistance^[15]

Parameter	Description	Test Conditions	100 TQFP Package	119 BGA Package	165 FBGA Package	Unit
Θ _{JA}	Thermal Resistance (Junction to Ambient)	Test conditions follow standard test methods and procedures for measuring thermal impedance, per EIA/JESD51.	29.41	34.1	16.8	°C/W
Θ _{JC}	Thermal Resistance (Junction to Case)		6.31	14.0	3.0	°C/W

AC Test Loads and Waveforms

3.3V I/O Test Load

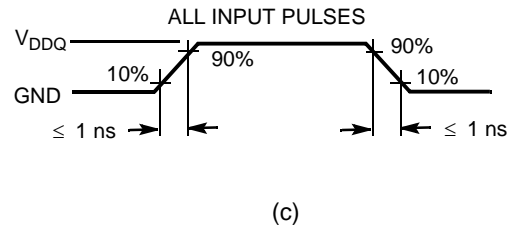
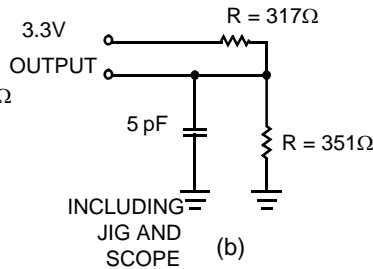
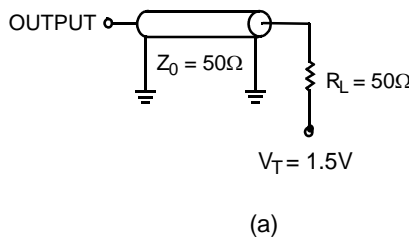

2.5V I/O Test Load

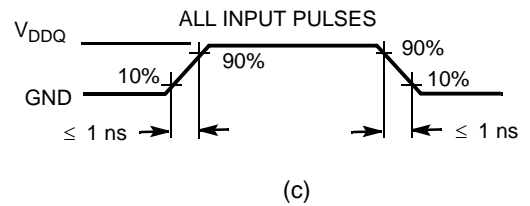
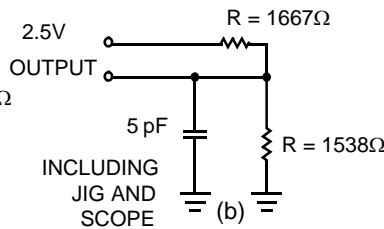
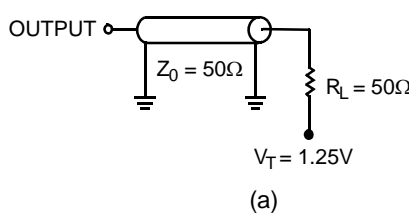

Note:

15. Tested initially and after any design or process change that may affect these parameters

Switching Characteristics Over the Operating Range ^[16, 17]

Parameter	Description	-133		-100		Unit
		Min.	Max.	Min.	Max.	
t _{POWER}	V _{DD} (Typical) to the First Access ^[18]	1		1		ms
Clock						
t _{CYC}	Clock Cycle Time	7.5		10		ns
t _{CH}	Clock HIGH	3.0		4.0		ns
t _{CL}	Clock LOW	3.0		4.0		ns
Output Times						
t _{CDV}	Data Output Valid after CLK Rise		6.5		7.5	ns
t _{DOH}	Data Output Hold after CLK Rise	2.0		2.0		ns
t _{CLZ}	Clock to Low-Z ^[19, 20, 21]	0		0		ns
t _{CHZ}	Clock to High-Z ^[19, 20, 21]		3.5		3.5	ns
t _{OEV}	OE LOW to Output Valid		3.5		3.5	ns
t _{OELZ}	OE LOW to Output Low-Z ^[19, 20, 21]	0		0		ns
t _{OEHZ}	OE HIGH to Output High-Z ^[19, 20, 21]		3.5		3.5	ns
Set-up Times						
t _{AS}	Address Set-up before CLK Rise	1.5		1.5		ns
t _{ALS}	ADV/LD Set-up before CLK Rise	1.5		1.5		ns
t _{WES}	WE, BW _X Set-up before CLK Rise	1.5		1.5		ns
t _{CENS}	CEN Set-up before CLK Rise	1.5		1.5		ns
t _{DS}	Data Input Set-up before CLK Rise	1.5		1.5		ns
t _{CES}	Chip Enable Set-Up before CLK Rise	1.5		1.5		ns
Hold Times						
t _{AH}	Address Hold after CLK Rise	0.5		0.5		ns
t _{ALH}	ADV/LD Hold after CLK Rise	0.5		0.5		ns
t _{WEH}	WE, BW _X Hold after CLK Rise	0.5		0.5		ns
t _{CENH}	CEN Hold after CLK Rise	0.5		0.5		ns
t _{DH}	Data Input Hold after CLK Rise	0.5		0.5		ns
t _{CEH}	Chip Enable Hold after CLK Rise	0.5		0.5		ns

Notes:

16. Timing reference level is 1.5V when V_{DDQ} = 3.3V and is 1.25V when V_{DDQ} = 2.5V.

17. Test conditions shown in (a) of AC Test Loads unless otherwise noted.

18. This part has a voltage regulator internally; t_{POWER} is the time that the power needs to be supplied above V_{DD}(minimum) initially, before a Read or Write operation can be initiated.

19. t_{CHZ}, t_{CLZ}, t_{OELZ}, and t_{OEHZ} are specified with AC test conditions shown in part (b) of AC Test Loads. Transition is measured ± 200 mV from steady-state voltage.

20. At any given voltage and temperature, t_{OEHZ} is less than t_{OELZ} and t_{CHZ} is less than t_{CLZ} to eliminate bus contention between SRAMs when sharing the same data bus. These specifications do not imply a bus contention condition, but reflect parameters guaranteed over worst case user conditions. Device is designed to achieve High-Z prior to Low-Z under the same system conditions.

21. This parameter is sampled and not 100% tested.

Switching Waveforms

Read/Write Waveforms^[22, 23, 24]

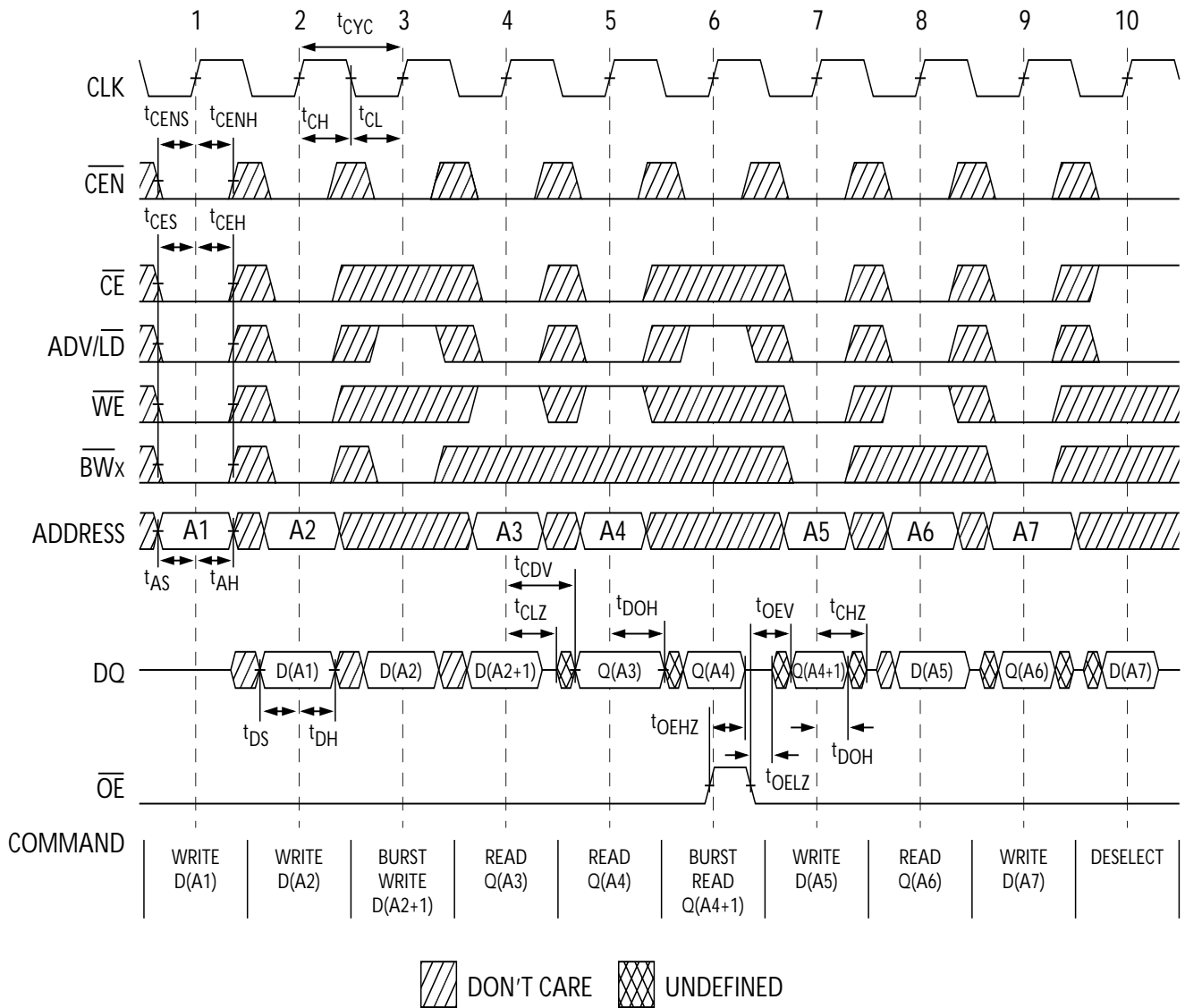

Notes:

22. For this waveform ZZ is tied LOW.

23. When \overline{CE} is LOW, \overline{CE}_1 is LOW, \overline{CE}_2 is HIGH and \overline{CE}_3 is LOW. When \overline{CE} is HIGH, \overline{CE}_1 is HIGH or \overline{CE}_2 is LOW or \overline{CE}_3 is HIGH.

24. Order of the Burst sequence is determined by the status of the MODE (0 = Linear, 1 = Interleaved). Burst operations are optional.

Switching Waveforms (continued)
ZZ Mode Timing^[26, 27]

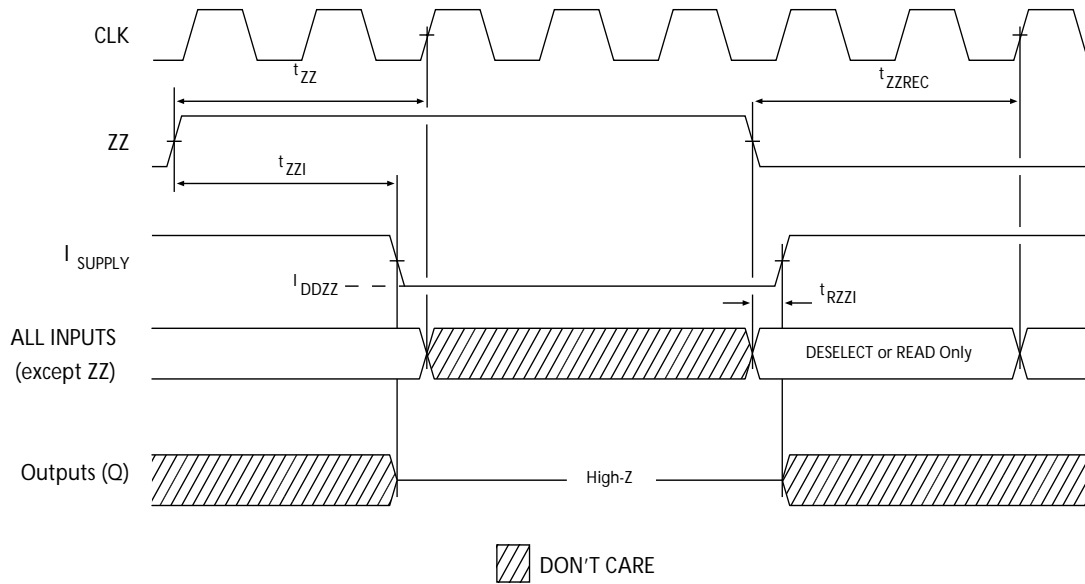

- Notes:**
 26. Device must be deselected when entering ZZ mode. See truth table for all possible signal conditions to deselect the device.
 27. DQs are in high-Z when exiting ZZ sleep mode.

Ordering Information

Not all of the speed, package and temperature ranges are available. Please contact your local sales representative or visit www.cypress.com for actual products offered.

Speed (MHz)	Ordering Code	Package Diagram	Part and Package Type	Operating Range	
133	CY7C1355C-133AXC	51-85050	100-Pin Thin Quad Flat Pack (14 x 20 x 1.4 mm) Lead-Free	Commercial	
	CY7C1357C-133AXC				
	CY7C1355C-133BGC	51-85115	119-ball Ball Grid Array (14 x 22 x 2.4 mm)		
	CY7C1357C-133BGC				
	CY7C1355C-133BGXC	51-85115	119-ball Ball Grid Array (14 x 22 x 2.4 mm) Lead-Free		
	CY7C1357C-133BGXC				
	CY7C1355C-133BZC	51-85180	165-ball Fine-Pitch Ball Grid Array (13 x 15 x 1.4 mm)		
	CY7C1357C-133BZC				
	CY7C1355C-133BZXC	51-85180	165-ball Fine-Pitch Ball Grid Array (13 x 15 x 1.4 mm) Lead-Free		
	CY7C1357C-133BZXC				
	CY7C1355C-133AXI	51-85050	100-Pin Thin Quad Flat Pack (14 x 20 x 1.4 mm) Lead-Free		Industrial
	CY7C1357C-133AXI				
	CY7C1355C-133BGI	51-85115	119-ball Ball Grid Array (14 x 22 x 2.4 mm)		
	CY7C1357C-133BGI				
	CY7C1355C-133BGXI	51-85115	119-ball Ball Grid Array (14 x 22 x 2.4 mm) Lead-Free		
	CY7C1357C-133BGXI				
CY7C1355C-133BZI	51-85180	165-ball Fine-Pitch Ball Grid Array (13 x 15 x 1.4 mm)			
CY7C1357C-133BZI					
CY7C1355C-133BZXI	51-85180	165-ball Fine-Pitch Ball Grid Array (13 x 15 x 1.4 mm) Lead-Free			
CY7C1357C-133BZXI					
100	CY7C1355C-100AXC	51-85050	100-Pin Thin Quad Flat Pack (14 x 20 x 1.4 mm) Lead-Free	Commercial	
	CY7C1357C-100AXC				
	CY7C1355C-100BGC	51-85115	119-ball Ball Grid Array (14 x 22 x 2.4 mm)		
	CY7C1357C-100BGC				
	CY7C1355C-100BGXC	51-85115	119-ball Ball Grid Array (14 x 22 x 2.4 mm) Lead-Free		
	CY7C1357C-100BGXC				
	CY7C1355C-100BZC	51-85180	165-ball Fine-Pitch Ball Grid Array (13 x 15 x 1.4 mm)		
	CY7C1357C-100BZC				
	CY7C1355C-100BZXC	51-85180	165-ball Fine-Pitch Ball Grid Array (13 x 15 x 1.4 mm) Lead-Free		
	CY7C1357C-100BZXC				
	CY7C1355C-100AXI	51-85050	100-Pin Thin Quad Flat Pack (14 x 20 x 1.4 mm) Lead-Free		Industrial
	CY7C1357C-100AXI				
	CY7C1355C-100BGI	51-85115	119-ball Ball Grid Array (14 x 22 x 2.4 mm)		
	CY7C1357C-100BGI				
	CY7C1355C-100BGXI	51-85115	119-ball Ball Grid Array (14 x 22 x 2.4 mm) Lead-Free		
	CY7C1357C-100BGXI				
CY7C1355C-100BZI	51-85180	165-ball Fine-Pitch Ball Grid Array (13 x 15 x 1.4 mm)			
CY7C1357C-100BZI					
CY7C1355C-100BZXI	51-85180	165-ball Fine-Pitch Ball Grid Array (13 x 15 x 1.4 mm) Lead-Free			
CY7C1357C-100BZXI					

Package Diagrams (continued)

119-Ball BGA (14 x 22 x 2.4 mm) (51-85115)

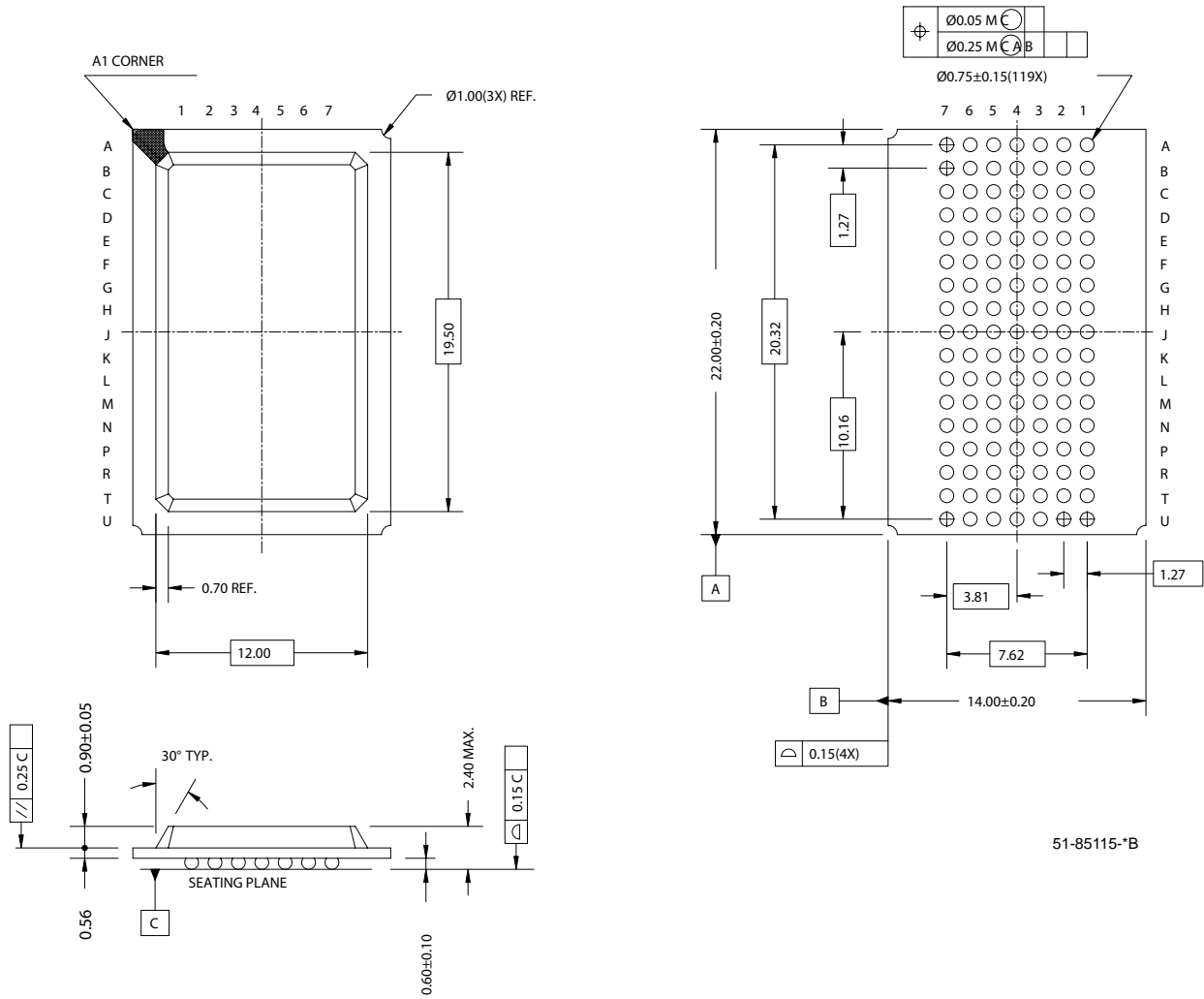

Package Diagrams (continued)

165-Ball FBGA (13 x 15 x 1.4 mm) (51-85180)

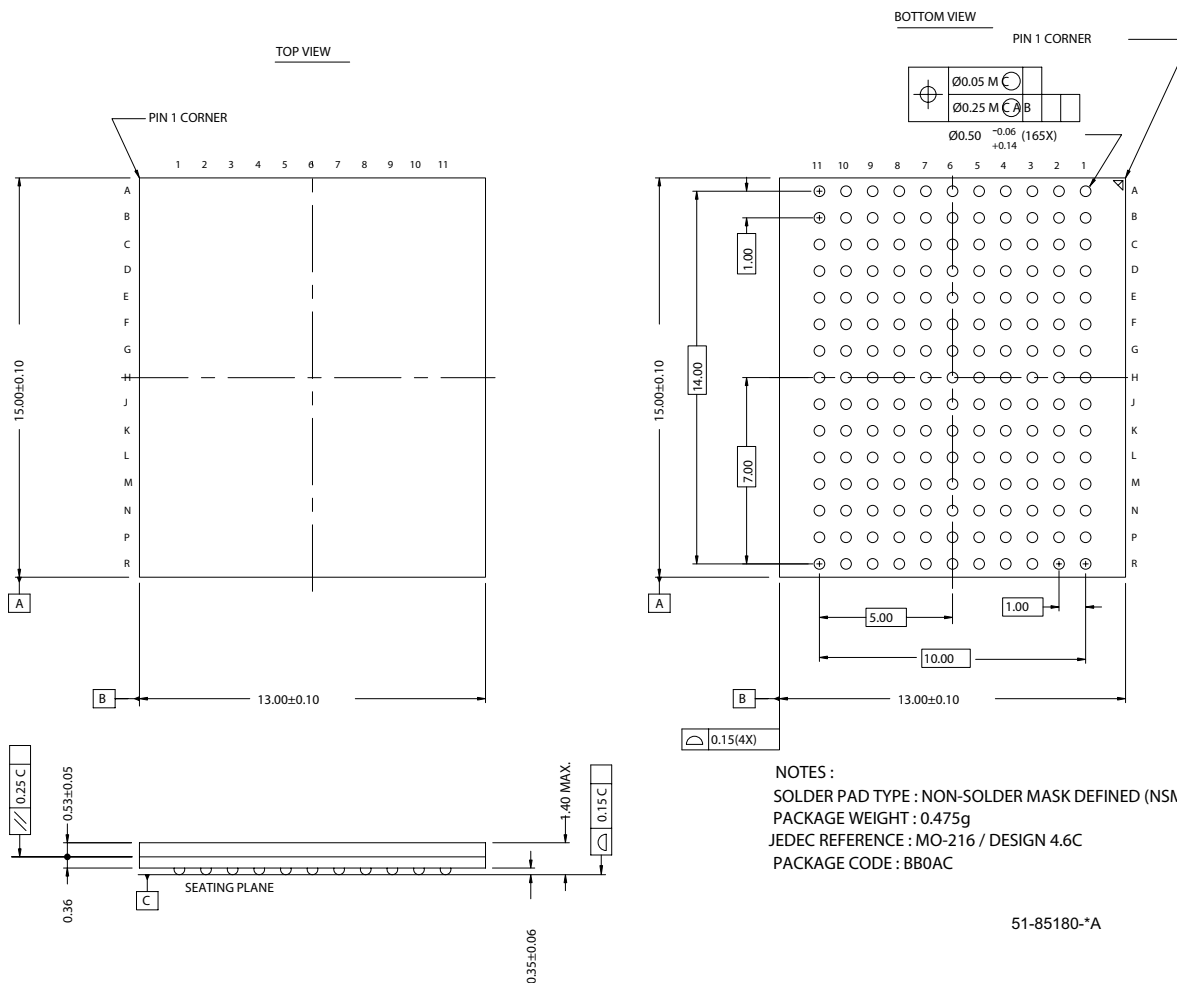

NoBL and No Bus Latency are trademarks of Cypress Semiconductor Corporation. ZBT is a trademark of Integrated Device Technology, Inc. All product and company names mentioned in this document are the trademarks of their respective holders

Document History Page

Document Title: CY7C1355C/CY7C1357C 9-Mbit (256K x 36/512K x 18) Flow-Through SRAM with NoBL™ Architecture				
Document Number: 38-05539				
REV.	ECN NO.	Issue Date	Orig. of Change	Description of Change
**	242032	See ECN	RKF	New data sheet
*A	332059	See ECN	PCI	<p>Changed Boundary Scan Order to match the B rev of these devices</p> <p>Removed description on Extest Output Bus Tri-state</p> <p>Removed 117 MHz Speed Bin</p> <p>Changed I_{DDZ} from 35 mA to 50 mA on Pg # 9</p> <p>Changed I_{SB1} and I_{SB3} from 40 mA to 110 and 100 mA respectively</p> <p>Address expansion pins/balls in the pinouts for all packages are modified as per JEDEC standard</p> <p>Modified V_{OL}, V_{OH} test conditions</p> <p>Corrected I_{SB4} Test Condition from (V_{IN} ≥ V_{DD} - 0.3V or V_{IN} ≤ 0.3V) to (V_{IN} ≥ V_{IH} or V_{IN} ≤ V_{IL}) in the Electrical Characteristic Table on Pg #18</p> <p>Changed θ_{JA} and θ_{JC} for TQFP Package from 25 and 9 °C/W to 29.41 and 6.13 °C/W respectively</p> <p>Changed θ_{JA} and θ_{JC} for BGA Package from 25 and 6 °C/W to 34.1 and 14.0 °C/W respectively</p> <p>Changed θ_{JA} and θ_{JC} for FBGA Package from 27 and 6 °C/W to 16.8 and 3.0 °C/W respectively</p> <p>Added lead-free information for 100-pin TQFP, 119 BGA and 165 FBGA Packages</p> <p>Updated Ordering Information Table</p> <p>Changed from Preliminary to Final</p>
*B	351895	See ECN	PCI	<p>Changed I_{SB2} from 30 to 40 mA</p> <p>Updated Ordering Information Table</p>
*C	377095	See ECN	PCI	Modified test condition in note# 14 from V _{IH} ≤ V _{DD} to V _{IH} < V _{DD}
*D	408298	See ECN	RXU	<p>Changed address of Cypress Semiconductor Corporation on Page# 1 from "3901 North First Street" to "198 Champion Court"</p> <p>Modified "Input Load" to "Input Leakage Current except ZZ and MODE" in the Electrical Characteristics Table</p> <p>Changed three-state to tri-state</p> <p>Replaced Package Name column with Package Diagram in the Ordering Information table</p> <p>Updated Ordering Information Table</p>
*E	501793	See ECN	VKN	<p>Added the Maximum Rating for Supply Voltage on V_{DDQ} Relative to GND</p> <p>Changed t_{TH}, t_{TL} from 25 ns to 20 ns and t_{TDOV} from 5 ns to 10 ns in TAP AC Switching Characteristics table.</p> <p>Updated the Ordering Information table.</p>

AMEYA360

Components Supply Platform

Authorized Distribution Brand :



Website :

Welcome to visit www.ameya360.com

Contact Us :

➤ Address :

401 Building No.5, JiuGe Business Center, Lane 2301, Yishan Rd
Minhang District, Shanghai , China

➤ Sales :

Direct +86 (21) 6401-6692

Email amall@ameya360.com

QQ 800077892

Skype [ameyasales1](#) [ameyasales2](#)

➤ Customer Service :

Email service@ameya360.com

➤ Partnership :

Tel +86 (21) 64016692-8333

Email mkt@ameya360.com