

L Series Miniature Slide Switches

Features/Benefits

- Positive detent
- Enclosed housing
- Maintained and momentary functions
- PC and panel mounting
- RoHS compliant



Models Available

Typical Applications

- Communications equipment
- Lighting devices

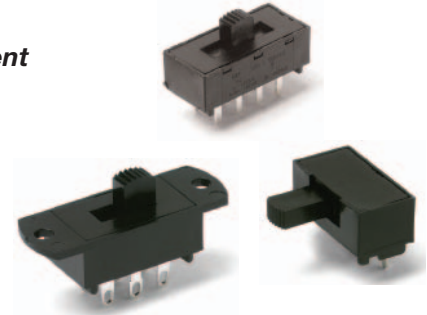

Specifications

CONTACT RATING: Q contact material (LX0X, LX1X Models): 4 AMPS @ 125 V AC or 28 V DC; 2 AMPS @ 250 V AC; 0.5 AMP @ 125 V DC (UL). See page I-23 for additional ratings.

ELECTRICAL LIFE: 10,000 make-and-break cycles at full load.

CONTACT RESISTANCE: Below 10 m Ω typ. initial @ 2-4 V DC, 100 mA, for both silver and gold plated contacts.

INSULATION RESISTANCE: 10⁹ Ω min.

DIELECTRIC STRENGTH: 1,000 Vrms min. @ sea level.

OPERATING TEMPERATURE: -30°C to +65°C

STORAGE TEMPERATURE: -30°C to +85°C

NOTE: Specifications and materials listed above are for switches with standard options. For information on specific and custom switches, consult Customer Service Center.

Materials

HOUSING: 6/6 nylon (UL94V-2), black.

ACTUATOR: 6/6 nylon (UL94V-2), black. '13' actuator, natural (standard).

CONTACTS: Q contact material: Copper, silver plated. See page I-23 for additional contact materials.

TERMINALS: Q contact material: Copper, silver plated. See page I-23 for additional contact materials.

CONTACT SPRING: Music wire or stainless steel.

TERMINAL SEAL: Epoxy.

NOTE: Any models supplied with Q, B or G contact material are RoHS compliant.

Build-A-Switch

To order, simply select desired option from each category and place in the appropriate box. Available options are shown and described on pages I-20 through I-24. For additional options not shown in catalog, consult Customer Service Center.

| | | | | | | | | | | | | | | | | | |
|--|--|---|--|---|--|--|--|--|--|---|--|---|--|---|--|---|--|
| <div style="border: 1px solid black; width: 100px; height: 15px; display: inline-block;"></div> | | <div style="border: 1px solid black; width: 100px; height: 15px; display: inline-block;"></div> | | <div style="border: 1px solid black; width: 100px; height: 15px; display: inline-block;"></div> | | <div style="border: 1px solid black; width: 100px; height: 15px; display: inline-block;"></div> | | <div style="border: 1px solid black; width: 100px; height: 15px; display: inline-block;"></div> | | <div style="border: 1px solid black; width: 100px; height: 15px; display: inline-block;"></div> | | <div style="border: 1px solid black; width: 100px; height: 15px; display: inline-block;"></div> | | <div style="border: 1px solid black; width: 100px; height: 15px; display: inline-block;"></div> | | <div style="border: 1px solid black; width: 100px; height: 15px; display: inline-block;"></div> | |
| Switch Function | | Actuator | | Detent | | Mounting Style | | Terminations | | Contact Material | | Seal | | Cap Color | | | |
| L202 DPDT L203 DP3T L101 SPST L102 SPDT L103 SP3T L104 SP4T L112 SPDT, mom. L113 SP3T, mom. to one end L123 SP3T, mom. to both ends L201 DPST L204 DP4T L212 DPDT, mom. | | 01 .200" high 02 .335" high 03 .375" high 05 .312" high 11 .100" high 12 Screwdriver slot 13 Plunger without cap 14 Plunger with .200" dia. cap 15 Plunger with .310" dia. cap 17 Plunger with .458" dia. cap 19 Plunger with .590" dia. cap | | 1 With detent 2 Without detent | | MS PC Thru-hole MA Right angle, PC thru-hole ML Right angle, PC thru-hole MV Right angle, PC thru-hole SS Panel with mounting ears TS Panel with integral mounting ears | | 02 PC Thru-hole 01 Solder lug with notch 03 Solder lug with hole 04 PC Thru-hole 10 PC Thru-hole 06 Wire wrap 12 PC Thru-hole | | Q Silver B Gold G Gold over silver | | NONE No seal E Epoxy seal | | 2 Black NONE No cap | | | |



Dimensions are shown: Inches (mm)
Specifications and dimensions subject to change



Slide

L Series Miniature Slide Switches

SWITCH AND LOCK FUNCTION

| NO. POLES | MODEL NO. | SWITCH FUNCTION | SCHEMATIC | AVAILABLE MOUNTING STYLES |
|-----------|-----------|------------------------|-----------|---------------------------|
| SP | L101 | SPST | | ML, MS, SS |
| | L102 | SPDT | | ML, MS, SS |
| | L112 | SPDT-MOM. | | ML, MS, MV, SS |
| | L103 | SP3T | | MA, MS, TS |
| | L113 | SP3T-MOM. to one end | | MA, MS, TS |
| | L123 | SP3T-MOM. to both ends | | MA, MS, TS |
| | L104 | SP4T | | MS |

| NO. POLES | MODEL NO. | SWITCH FUNCTION | SCHEMATIC | AVAILABLE MOUNTING STYLES |
|-----------|-----------|-----------------|-----------|---------------------------|
| DP | L201 | DPST | | MA, MS, SS |
| | L202 | DPDT | | MA, MS, SS |
| | L212 | DPDT-MOM. | | MV |
| | L203 | DP3T | | MS, TS |
| | L204 | DP4T | | MS |

NOTE: and MOM. in table indicates momentary action.

All models with all options when ordered with 'G' or 'Q' contact material.

Contacts make on side actuator thrown.

Slide

ACTUATOR



ACTUATOR OPTIONS FOR 'MS, MA, ML, SS, & TS' MOUNTING STYLES

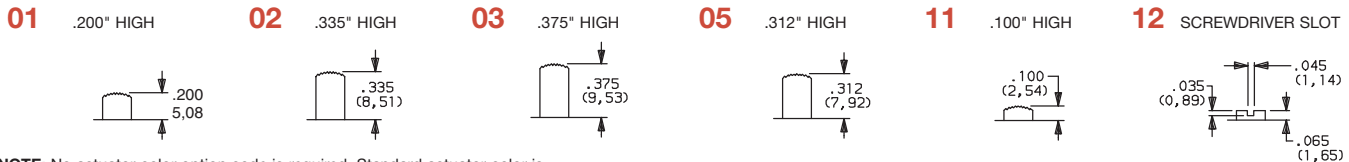

NOTE: No actuator color option code is required. Standard actuator color is black, other colors and heights available, consult Customer Service Center. See pages I-20 and I-22 for available mounting styles.

ACTUATOR OPTIONS FOR 'MV' MOUNTING STYLE

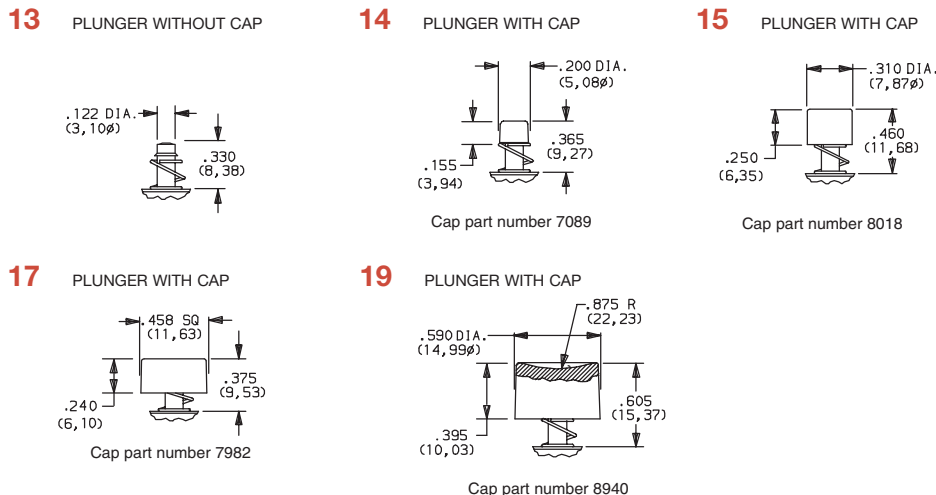

| OPTION CODE | ACTUATOR CAP COLORS |
|-------------|---------------------|
| 2 | BLACK |
| NONE | 01-13 ACTUATORS |

Other colors available, consult Customer Service Center.

ACTUATOR CAPS

Caps supplied are not installed standard. To order actuator options '14 thru 19,' select desired cap color from chart and place option code in last box of ordering format. Leave box empty for all other actuator options. Caps may also be ordered separately and user installed, see pages I-23 and I-24. Specify the four digit part number and desired cap color. For switches without caps, order '13' or '23' actuator option. Cap finish: gloss (excluding square cap part number 7982, finish: matte).

SPLASH CAPS

New protective splash caps for PC mounted slide switches are available separately and reusable. They provide splash protection during soldering and cleaning processes. To order specify correct part number, see page I-24.



Third Angle
Projection

Dimensions are shown: Inch (mm)
Specifications and dimensions subject to change



L Series Miniature Slide Switches

DETENT

- 1 WITH DETENT**
Standard with all maintained models: L101, L102, L103, L104, L113, L201, L202, L203 and L204.
- 2 WITHOUT DETENT**
Standard with all momentary models: L112, L123, and L212.

MOUNTING STYLE

MS PC THRU-HOLE, 2 POSITION MODELS

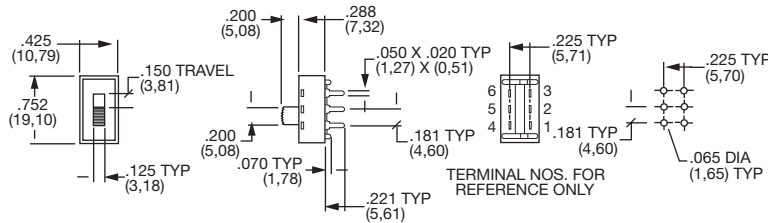

AVAILABLE WITH:

Models: L101, L102, L112, L103, L113 L123, L201, L202, L203, L104 and L204
Terminations: 02, 06, 10 and 12
Actuators: 01, 02, 03, 05, 11 and 12

PC MOUNTING

For mounting information, see TERMINATIONS section, page I-23.
 Splash caps are available separately and reusable, see page I-24.



L203011MS02Q
DP3T

PC THRU-HOLE, 3 POSITION MODELS

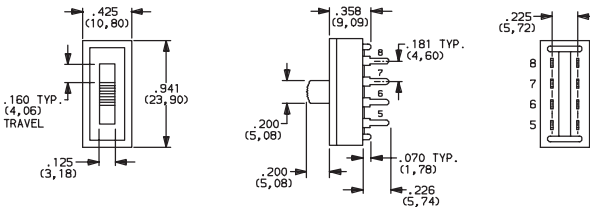

PC THRU HOLE, 4 POSITION MODELS

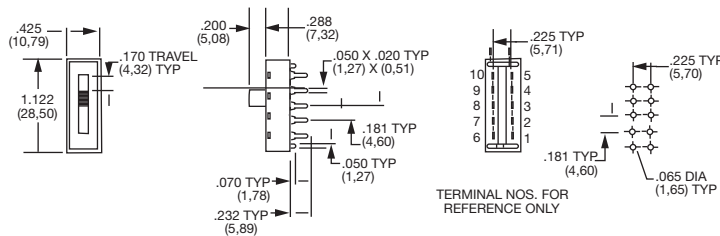

MA RIGHT ANGLE, PC THRU-HOLE

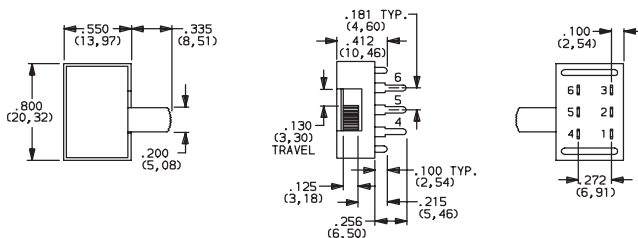

AVAILABLE WITH:

Models: L103, L201, L202, L113 and L123
Terminations: 04
Actuators: 02 and 12

PC MOUNTING

For mounting information, see TERMINATIONS section, page I-23.
 Splash caps are available separately and reusable, see page I-24.

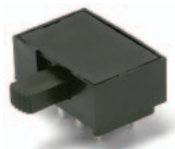

L202021MA04Q
Horizontal Actuation
DPDT

RIGHT ANGLE, PC, SP-3 POSITION MODELS

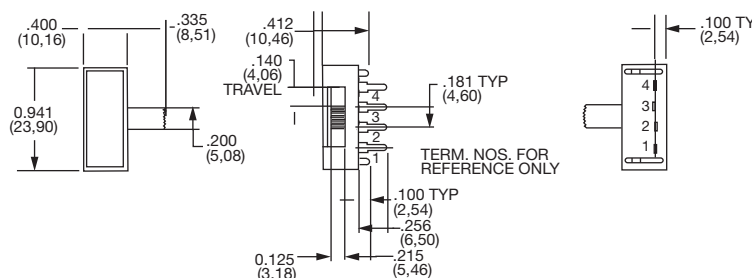

Third Angle Projection
 Dimensions are shown: Inches (mm)
 Specifications and dimensions subject to change



Slide

L Series Miniature Slide Switches

MOUNTING STYLE



ML RIGHT ANGLE, PC THRU-HOLE

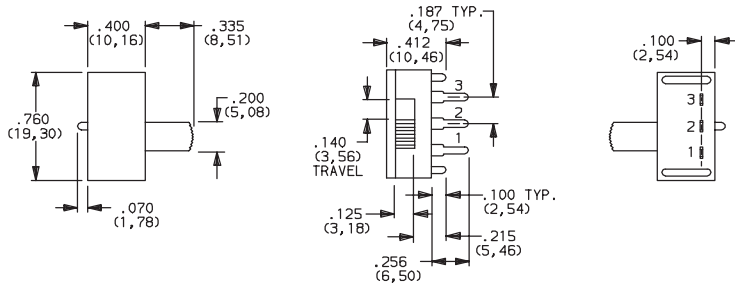

AVAILABLE WITH:

Models: L101, L102, L112
Terminations: 04
Actuators: 01, 02, 05, 11 and 12
PC MOUNTING

For mounting information, see TERMINATIONS section, page I-23.

Splash caps are available separately and reusable, see page I-24.



L102021ML04Q
Horizontal Actuation
SPDT

MV RIGHT ANGLE, PC THRU-HOLE

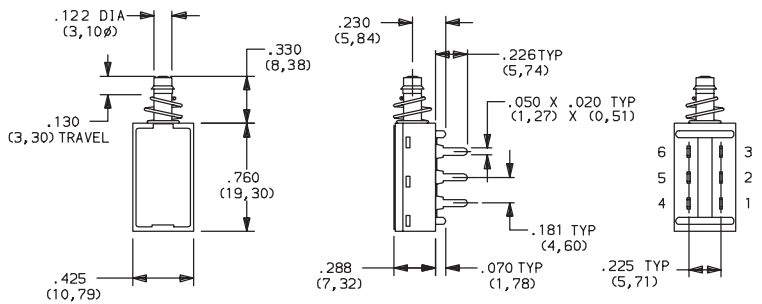

AVAILABLE WITH:

Models: L112 and L212
Terminations: 02, 06, 10 and 12
Actuators: 13 thru 19
PC MOUNTING

For mounting information, see TERMINATIONS section, page I-23.

Splash caps are available separately and reusable, see page I-24.



L212132MV02Q
DPDT

SS PANEL WITH MOUNTING EARS



L202011SS03Q
DPDT

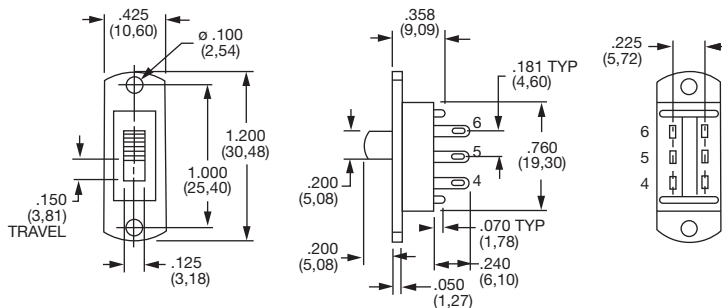

PANEL MOUNTING

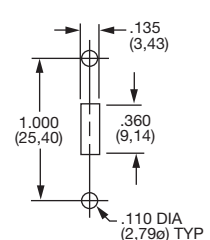

AVAILABLE WITH:

Models: L101, L102, L112, L201 and L202
Terminations: 01, 02, 03, 06, 10, 12
Actuators: 01, 02, 03, 05, 11 and 12

TS PANEL WITH INTEGRAL MOUNTING EARS

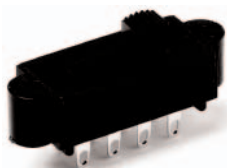

L203011TS03Q
DP3T

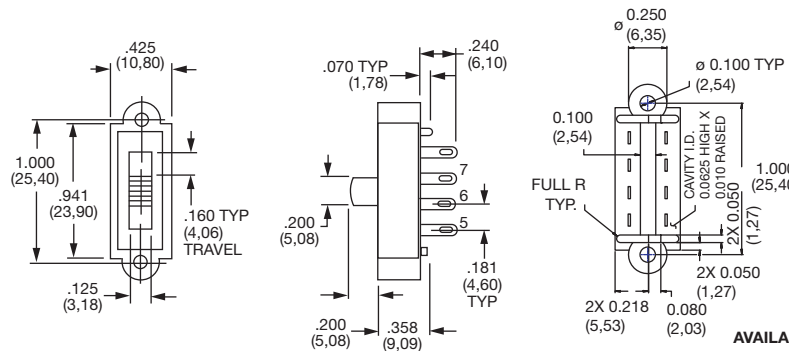

PANEL MOUNTING

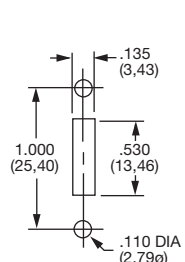

AVAILABLE WITH:

Models: L103, L113, L123 and L203
Terminations: 01, 02, 03, 06, 10, 12
Actuators: 01, 02, 03, 05, 11 and 12



Third Angle
Projection

Dimensions are shown: Inch (mm)

Specifications and dimensions subject to change

L Series Miniature Slide Switches

TERMINATIONS

'MS, MV, SS & TS' Mounting Styles Only

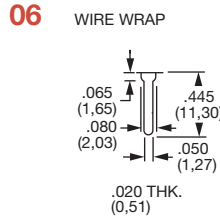
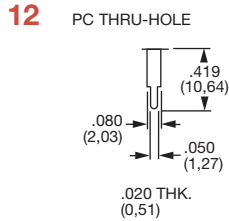
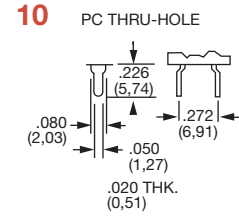
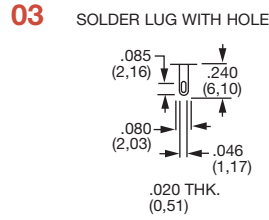
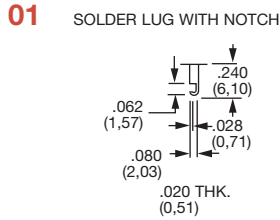
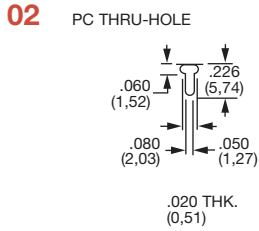

'MA & ML' Mounting Styles Only

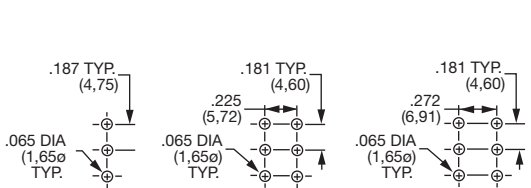
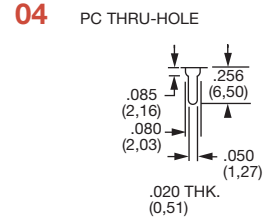

All models with '04' terminations and 'ML' mounting style.

All 2 position models, except '04' and '10' terminations.

All 2 position models with '04' and '10' terminations.

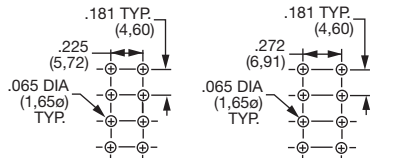

All 3 position models except '04' and '10' terminations.

All 3 position models, with '10' termination.

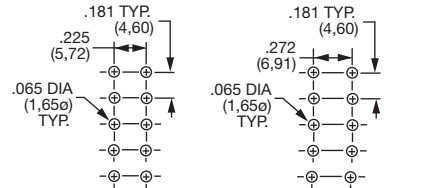

All 4 position models, except '04' and '10' terminations.

All 4 position models, with '10' terminations.

CONTACT MATERIAL

| OPTION CODE | CONTACT MATERIAL | RATINGS | |
|-------------|-------------------------------|--------------------------------|--|
| Q | SILVER ² | LOW LEVEL/DRY CIRCUIT | LX0X, LX1X MODELS: 4 AMPS @ 125 V AC or 28 V DC; 2 AMPS @ 250 V AC; 0.5 AMP @ 125 V DC (UL). LX6X MODELS: 4 AMPS @ 125 V AC or 28 V DC; 2 AMPS @ 250 V AC (UL). |
| B | GOLD ¹ | POWER | 0.4 VA MAX. @20 V AC OR DC max. |
| G | GOLD OVER SILVER ³ | LOW LEVEL/DRY CIRCUIT OR POWER | LX0X, LX1X MODELS: 0.4 VA MAX. @ 20 V AC or DC MAX. or 4 AMPS @ 125 V AC or 28 V DC; 2 AMPS @ 250 V AC; 0.5 AMP @ 125 V DC (UL). LX6X MODELS: 0.4 VA MAX. @ 20 V AC or DC MAX. or 4 AMPS @ 125 V AC or 28 V DC; 2 AMPS @ 250 V AC (UL). |

* Note: See Technical Data section of this catalog for RoHS compliant and compatible definitions and specifications.

¹ CONTACTS & TERMINALS: Copper, with gold plate over nickel plate.

² CONTACTS & TERMINALS: Copper, silver plated (standard with all termination options).

³ CONTACTS & TERMINALS: Copper, with gold plate over nickel plate over silver plate.

NOTE: Any models supplied with Q, B or G contact material are RoHS compliant.

All models with all options when ordered with 'G' or 'Q' contact material.

NOTE: 'G' contact material is equivalent to both 'B' and 'Q' contact materials.

SEAL

NONE NO SEAL

E EPOXY SEAL

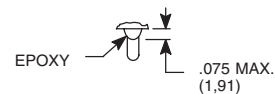

Third Angle Projection

Dimensions are shown: Inches (mm)
Specifications and dimensions subject to change



Slide

L Series Miniature Slide Switches

AVAILABLE HARDWARE



Slide

Cap
Compatible with 13-19 actuators

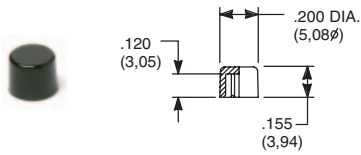

PART NO.
708902000 BLACK
708903000 RED

Material: Nylon
Finish: Gloss

Cap
Compatible with 13-19 actuators

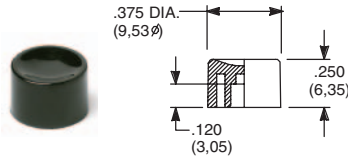

PART NO.
752702000 BLACK
752703000 RED

Material: Nylon
Finish: Gloss

Cap
Compatible with 13-19 actuators

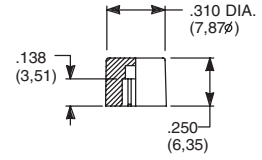

PART NO.
801802000 BLACK
801803000 RED

Material: Nylon
Finish: Gloss

Cap
Compatible with 13-19 actuators

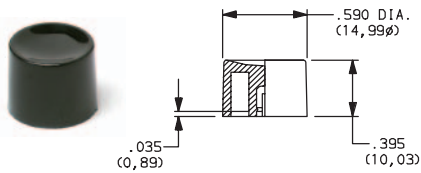

PART NO.
452D02000 BLACK
452D03000 RED

Material: Nylon
Finish: Gloss

Cap
Compatible with 13-19 actuators

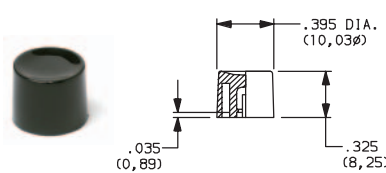

PART NO.
894102000 BLACK
894103000 RED

Material: Nylon
Finish: Gloss

Cap
Compatible with 13-19 actuators

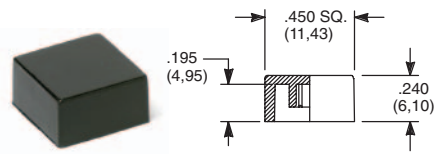

PART NO.
484602000 BLACK
484603000 RED

PART NO.
798202263 BLACK
798203000 RED

Material: Nylon
Finish: Gloss

Material: Nylon
Finish: Matte

Cap
Compatible with 01-05 actuators

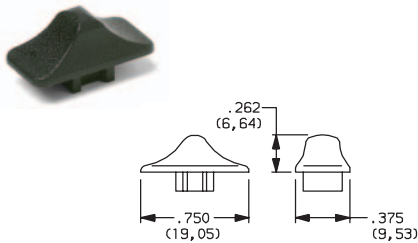

PART NO.
120100602 BLACK

Material: Nylon
Finish: Matte

Splash Cap



Fits 'MS' mounting style,
LXX1 & LXX2 models only.

PART NO.
120100200

Splash Cap

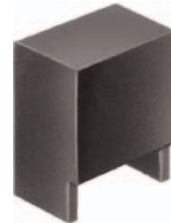

Fits 'MV' mounting style,
LX1X models only.

PART NO.
120100300

Material: Nylon

Splash Cap



Fits 'MA' mounting style,
LXX3 models only.

PART NO.
120100400

Material: Nylon

NOTE: Other colors available,
consult Customer Service Center.



Dimensions are shown: Inch (mm)
Specifications and dimensions subject to change



AMEYA360

Components Supply Platform

Authorized Distribution Brand :



Website :

Welcome to visit www.ameya360.com

Contact Us :

➤ Address :

401 Building No.5, JiuGe Business Center, Lane 2301, Yishan Rd
Minhang District, Shanghai , China

➤ Sales :

Direct +86 (21) 6401-6692

Email amall@ameya360.com

QQ 800077892

Skype ameyasales1 ameyasales2

➤ Customer Service :

Email service@ameya360.com

➤ Partnership :

Tel +86 (21) 64016692-8333

Email mkt@ameya360.com