

MMBT2907AM3T5G

PNP General Purpose Transistor

The MMBT2907AM3T5G device is a spin-off of our popular SOT-23 three-leaded device. It is designed for general purpose amplifier applications and is housed in the SOT-723 surface mount package. This device is ideal for low-power surface mount applications where board space is at a premium.

Features

- Reduces Board Space
- This is a Halide-Free Device
- This is a Pb-Free Device

MAXIMUM RATINGS

Rating	Symbol	Value	Unit
Collector-Emmitter Voltage	V_{CEO}	-60	Vdc
Collector-Base Voltage	V_{CBO}	-60	Vdc
Emitter-Base Voltage	V_{EBO}	-5.0	Vdc
Collector Current - Continuous	I_C	-600	mA

THERMAL CHARACTERISTICS

Characteristic	Symbol	Max	Unit
Total Device Dissipation FR-5 Board (Note 1) $T_A = 25^\circ\text{C}$ Derate above 25°C	P_D	265 2.1	mW mW/ $^\circ\text{C}$
Thermal Resistance, Junction-to-Ambient	$R_{\theta JA}$	470	$^\circ\text{C}/\text{W}$
Total Device Dissipation Alumina Substrate, (Note 2) $T_A = 25^\circ\text{C}$ Derate above 25°C	P_D	640 5.1	mW mW/ $^\circ\text{C}$
Thermal Resistance, Junction-to-Ambient	$R_{\theta JA}$	195	$^\circ\text{C}/\text{W}$
Junction and Storage Temperature	T_J, T_{stg}	-55 to +150	$^\circ\text{C}$

Stresses exceeding Maximum Ratings may damage the device. Maximum Ratings are stress ratings only. Functional operation above the Recommended Operating Conditions is not implied. Extended exposure to stresses above the Recommended Operating Conditions may affect device reliability.

1. FR-5 = $1.0 \times 0.75 \times 0.062$ in.
2. Alumina = $0.4 \times 0.3 \times 0.024$ in. 99.5% alumina.



ON Semiconductor®

<http://onsemi.com>

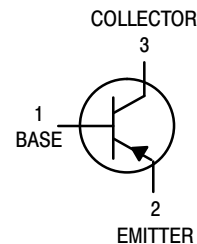

MARKING DIAGRAM

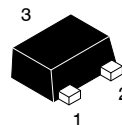

SOT-723
CASE 631AA
STYLE 1



AC = Specific Device Code
M = Date Code

ORDERING INFORMATION

Device	Package	Shipping†
MMBT2907AM3T5G	SOT-723 (Pb-Free)	8000/Tape & Reel

†For information on tape and reel specifications, including part orientation and tape sizes, please refer to our Tape and Reel Packaging Specifications Brochure, BRD8011/D.

MMBT2907AM3T5G

ELECTRICAL CHARACTERISTICS ($T_A = 25^\circ\text{C}$ unless otherwise noted)

Characteristic	Symbol	Min	Max	Unit
OFF CHARACTERISTICS				
Collector–Emitter Breakdown Voltage (Note 3) ($I_C = -10\text{ mAdc}$, $I_B = 0$)	$V_{(BR)CEO}$	-60	-	Vdc
Collector–Base Breakdown Voltage ($I_C = -10\ \mu\text{Adc}$, $I_E = 0$)	$V_{(BR)CBO}$	-60	-	Vdc
Emitter–Base Breakdown Voltage ($I_E = -10\ \mu\text{Adc}$, $I_C = 0$)	$V_{(BR)EBO}$	-5.0	-	Vdc
Collector Cutoff Current ($V_{CE} = -30\text{ Vdc}$, $V_{EB(off)} = -0.5\text{ Vdc}$)	I_{CEX}	-	-50	nAdc
Collector Cutoff Current ($V_{CB} = -50\text{ Vdc}$, $I_E = 0$) ($V_{CB} = -50\text{ Vdc}$, $I_E = 0$, $T_A = 125^\circ\text{C}$)	I_{CBO}	-	-0.010 -10	μAdc
Base Cutoff Current ($V_{CE} = -30\text{ Vdc}$, $V_{EB(off)} = -0.5\text{ Vdc}$)	I_{BL}	-	-50	nAdc

ON CHARACTERISTICS

DC Current Gain ($I_C = -0.1\text{ mAdc}$, $V_{CE} = -10\text{ Vdc}$) ($I_C = -1.0\text{ mAdc}$, $V_{CE} = -10\text{ Vdc}$) ($I_C = -10\text{ mAdc}$, $V_{CE} = -10\text{ Vdc}$) ($I_C = -150\text{ mAdc}$, $V_{CE} = -10\text{ Vdc}$) ($I_C = -500\text{ mAdc}$, $V_{CE} = -10\text{ Vdc}$) (Note 3)	h_{FE}	75 100 100 100 50	- - - 300 -	-
Collector–Emitter Saturation Voltage (Note 3) ($I_C = -150\text{ mAdc}$, $I_B = -15\text{ mAdc}$) (Note 3) ($I_C = -500\text{ mAdc}$, $I_B = -50\text{ mAdc}$)	$V_{CE(sat)}$	- -	-0.4 -1.6	Vdc
Base–Emitter Saturation Voltage (Note 3) ($I_C = -150\text{ mAdc}$, $I_B = -15\text{ mAdc}$) ($I_C = -500\text{ mAdc}$, $I_B = -50\text{ mAdc}$)	$V_{BE(sat)}$	- -	-1.3 -2.6	Vdc

SMALL-SIGNAL CHARACTERISTICS

Current–Gain – Bandwidth Product (Notes 3, 4) ($I_C = -50\text{ mAdc}$, $V_{CE} = -20\text{ Vdc}$, $f = 100\text{ MHz}$)	f_T	200	-	MHz
Output Capacitance ($V_{CB} = -10\text{ Vdc}$, $I_E = 0$, $f = 1.0\text{ MHz}$)	C_{obo}	-	8.0	pF
Input Capacitance ($V_{EB} = -2.0\text{ Vdc}$, $I_C = 0$, $f = 1.0\text{ MHz}$)	C_{ibo}	-	30	

SWITCHING CHARACTERISTICS

Turn–On Time	$(V_{CC} = -30\text{ Vdc}$, $I_C = -150\text{ mAdc}$, $I_{B1} = -15\text{ mAdc}$)	t_{on}	-	45	ns
Delay Time		t_d	-	10	
Rise Time		t_r	-	40	
Turn–Off Time	$(V_{CC} = -6.0\text{ Vdc}$, $I_C = -150\text{ mAdc}$, $I_{B1} = I_{B2} = -15\text{ mAdc}$)	t_{off}	-	100	
Storage Time		t_s	-	80	
Fall Time		t_f	-	30	

3. Pulse Test: Pulse Width $\leq 300\ \mu\text{s}$, Duty Cycle $\leq 2.0\%$.

4. f_T is defined as the frequency at which $|h_{fe}|$ extrapolates to unity.

MMBT2907AM3T5G

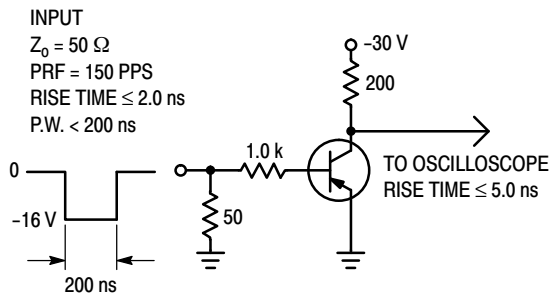

Figure 1. Delay and Rise Time Test Circuit

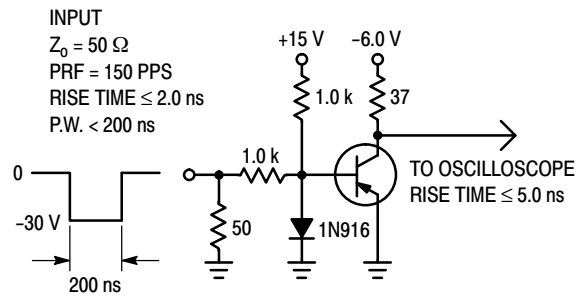

Figure 2. Storage and Fall Time Test Circuit

MMBT2907AM3T5G

TYPICAL CHARACTERISTICS

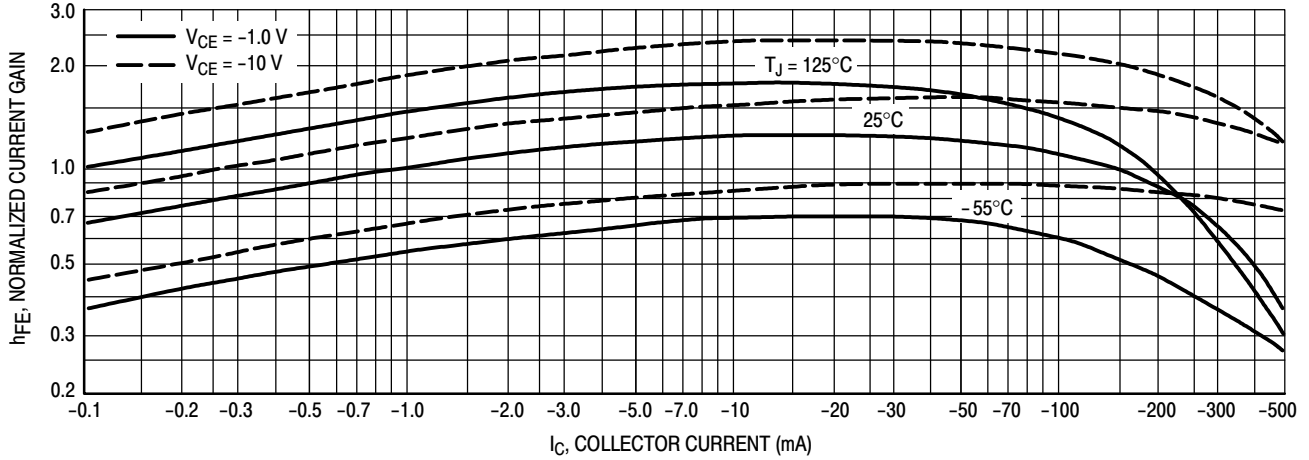

Figure 3. DC Current Gain

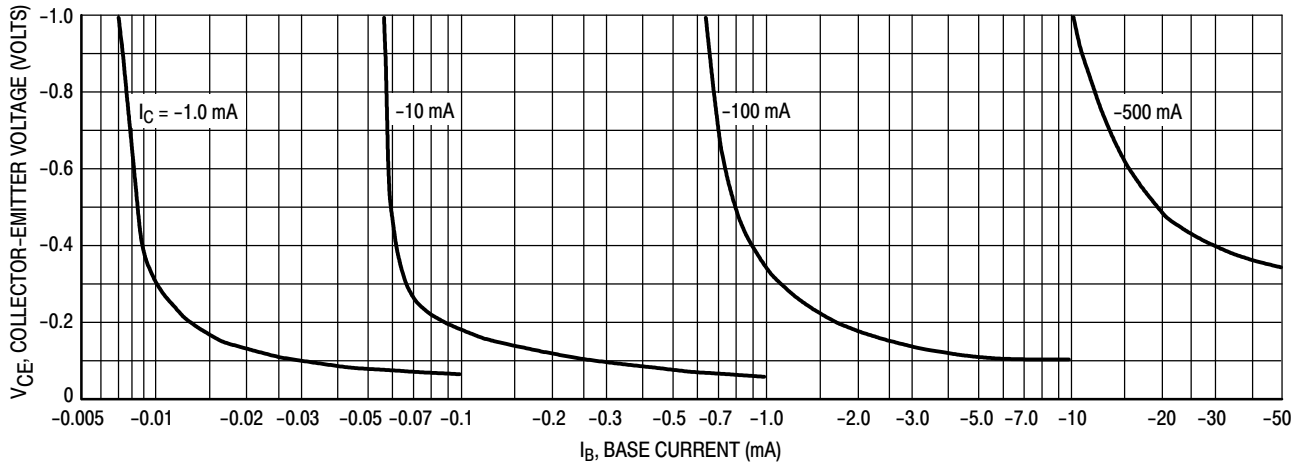

Figure 4. Collector Saturation Region

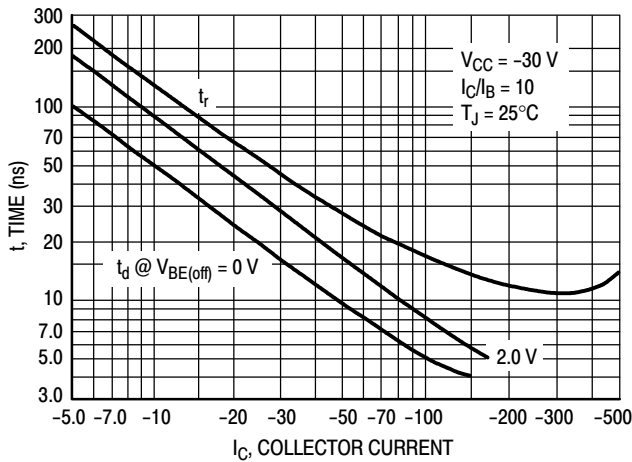

Figure 5. Turn-On Time

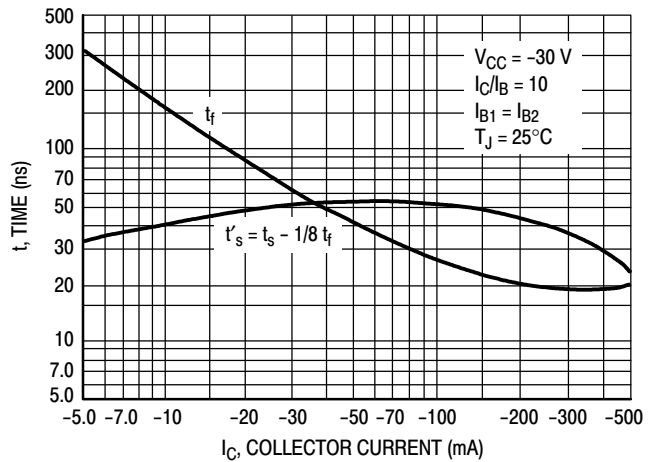

Figure 6. Turn-Off Time

MMBT2907AM3T5G

TYPICAL SMALL-SIGNAL Characteristics NOISE FIGURE

$V_{CE} = 10 \text{ Vdc}$, $T_A = 25^\circ\text{C}$

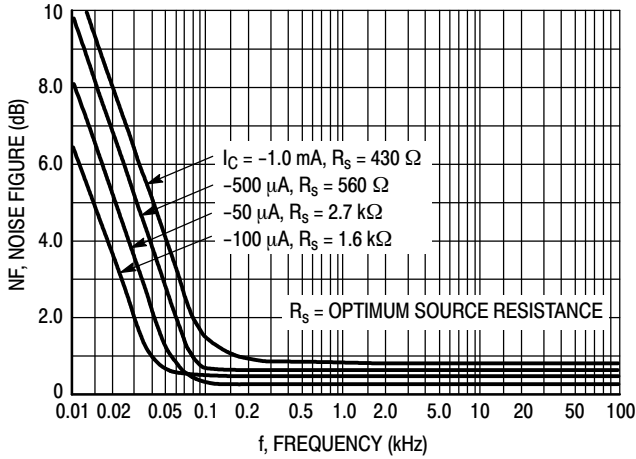

Figure 7. Frequency Effects

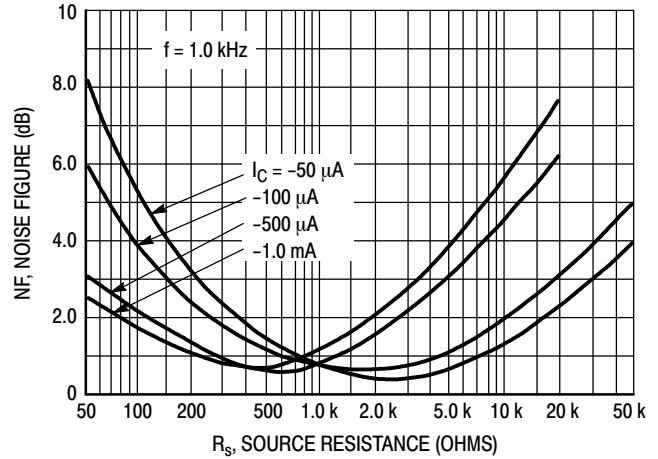

Figure 8. Source Resistance Effects

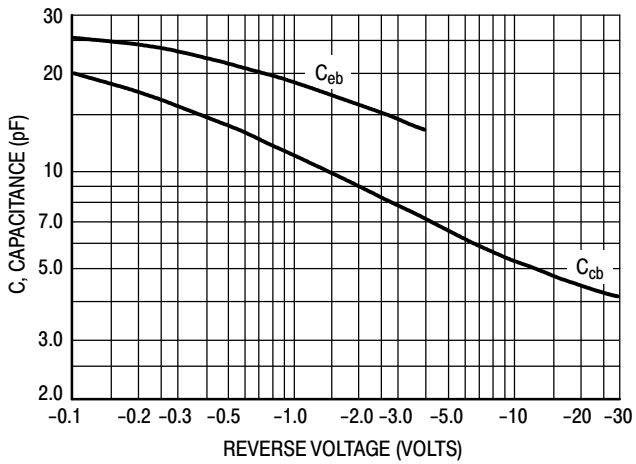

Figure 9. Capacitances

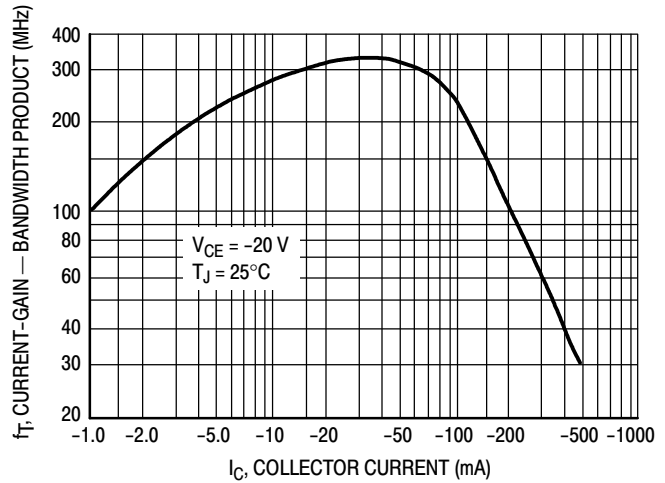

Figure 10. Current-Gain - Bandwidth Product

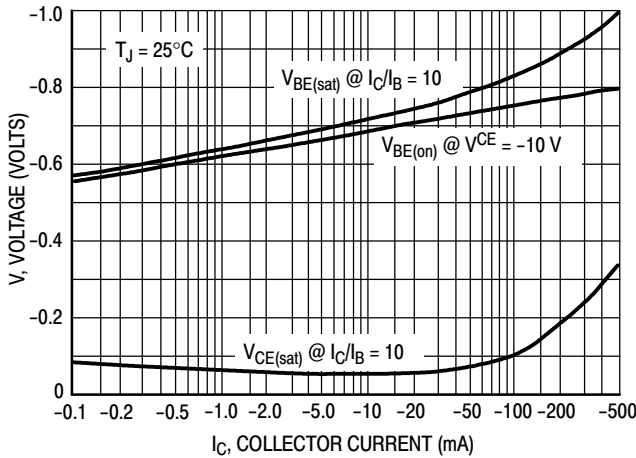

Figure 11. "On" Voltage

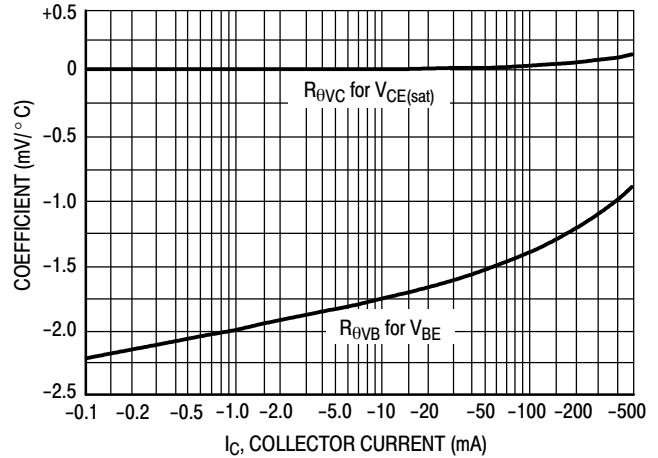
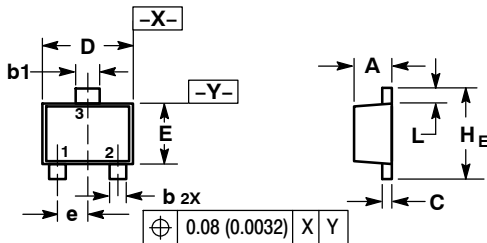

Figure 12. Temperature Coefficients

MMBT2907AM3T5G

PACKAGE DIMENSIONS

SOT-723
CASE 631AA-01
ISSUE C



NOTES:

1. DIMENSIONING AND TOLERANCING PER ANSI Y14.5M, 1982.
2. CONTROLLING DIMENSION: MILLIMETERS.
3. MAXIMUM LEAD THICKNESS INCLUDES LEAD FINISH. MINIMUM LEAD THICKNESS IS THE MINIMUM THICKNESS OF BASE MATERIAL.
4. DIMENSIONS D AND E DO NOT INCLUDE MOLD FLASH, PROTRUSIONS OR GATE BURRS.

DIM	MILLIMETERS			INCHES		
	MIN	NOM	MAX	MIN	NOM	MAX
A	0.45	0.50	0.55	0.018	0.020	0.022
b	0.15	0.21	0.27	0.0059	0.0083	0.0106
b1	0.25	0.31	0.37	0.010	0.012	0.015
C	0.07	0.12	0.17	0.0028	0.0047	0.0067
D	1.15	1.20	1.25	0.045	0.047	0.049
E	0.75	0.80	0.85	0.03	0.032	0.034
e	0.40 BSC			0.016 BSC		
H E	1.15	1.20	1.25	0.045	0.047	0.049
L	0.15	0.20	0.25	0.0059	0.0079	0.0098

STYLE 1:
PIN 1. BASE
2. EMITTER
3. COLLECTOR

SOLDERING FOOTPRINT*

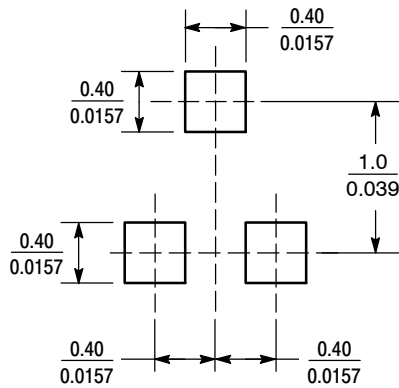

SCALE 20:1 (mm/inches)

*For additional information on our Pb-Free strategy and soldering details, please download the ON Semiconductor Soldering and Mounting Techniques Reference Manual, SOLDERRM/D.

ON Semiconductor and are registered trademarks of Semiconductor Components Industries, LLC (SCILLC). SCILLC reserves the right to make changes without further notice to any products herein. SCILLC makes no warranty, representation or guarantee regarding the suitability of its products for any particular purpose, nor does SCILLC assume any liability arising out of the application or use of any product or circuit, and specifically disclaims any and all liability, including without limitation special, consequential or incidental damages. "Typical" parameters which may be provided in SCILLC data sheets and/or specifications can and do vary in different applications and actual performance may vary over time. All operating parameters, including "Typicals" must be validated for each customer application by customer's technical experts. SCILLC does not convey any license under its patent rights nor the rights of others. SCILLC products are not designed, intended, or authorized for use as components in systems intended for surgical implant into the body, or other applications intended to support or sustain life, or for any other application in which the failure of the SCILLC product could create a situation where personal injury or death may occur. Should Buyer purchase or use SCILLC products for any such unintended or unauthorized application, Buyer shall indemnify and hold SCILLC and its officers, employees, subsidiaries, affiliates, and distributors harmless against all claims, costs, damages, and expenses, and reasonable attorney fees arising out of, directly or indirectly, any claim of personal injury or death associated with such unintended or unauthorized use, even if such claim alleges that SCILLC was negligent regarding the design or manufacture of the part. SCILLC is an Equal Opportunity/Affirmative Action Employer. This literature is subject to all applicable copyright laws and is not for resale in any manner.

PUBLICATION ORDERING INFORMATION

LITERATURE FULFILLMENT:
Literature Distribution Center for ON Semiconductor
P.O. Box 5163, Denver, Colorado 80217 USA
Phone: 303-675-2175 or 800-344-3860 Toll Free USA/Canada
Fax: 303-675-2176 or 800-344-3867 Toll Free USA/Canada
Email: orderlit@onsemi.com

N. American Technical Support: 800-282-9855 Toll Free
USA/Canada
Europe, Middle East and Africa Technical Support:
Phone: 421 33 790 2910
Japan Customer Focus Center
Phone: 81-3-5773-3850

ON Semiconductor Website: www.onsemi.com

Order Literature: <http://www.onsemi.com/orderlit>

For additional information, please contact your local Sales Representative

AMEYA360

Components Supply Platform

Authorized Distribution Brand :



Website :

Welcome to visit www.ameya360.com

Contact Us :

➤ Address :

401 Building No.5, JiuGe Business Center, Lane 2301, Yishan Rd
Minhang District, Shanghai , China

➤ Sales :

Direct +86 (21) 6401-6692

Email amall@ameya360.com

QQ 800077892

Skype [ameyasales1](#) [ameyasales2](#)

➤ Customer Service :

Email service@ameya360.com

➤ Partnership :

Tel +86 (21) 64016692-8333

Email mkt@ameya360.com